

INSTALLATION INSTRUCTIONS

MANROSE®

Jestream Hand Dryer

FAN7427 - White

FAN7428 - Polished

TECHNICAL SPECIFICATIONS

Supply: 220 – 240V AC

Total Power: 1350 W

Air Speed: 80 m/s

Dry Time: 9-11 sec

Housing: Stainless Steel 304

Auto Shut Off: 60 sec

Sound Level: 70 dB(A)

Safety: Class I

IP Rating: IP23

IK Rating: IK08

Dimensions (A x B x C): 238 x 267 x 175 mm

Net Weight: 3.8 kg

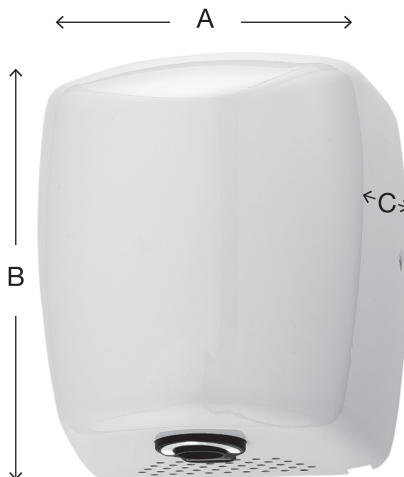

PLEASE READ ALL INSTRUCTIONS CAREFULLY BEFORE STARTING THE INSTALLATION

! IMPORTANT

This product is suitable for use only with a supply voltage of 230-240V AC, 50Hz.

All electrical work must be carried out in accordance with local and national electrical codes as applicable.

We strongly recommend that this device is installed by a registered electrician.

Always switch power off prior to installation, A means of mains power isolation must be installed in the circuit for the purpose of safe access for any internal cleaning, recalibration, or maintenance.

This device is not intended for use by persons (including children) with reduced physical, sensory or mental capabilities, or lack of experience and knowledge, unless they have been given supervision or instruction concerning use of the appliance by a person responsible for their safety. Young children should be supervised to ensure that they do not play with the appliance.

Any changes or modifications made or attempted to this product, without the prior written approval of the manufacturer, will void any and all stated warranties.

BEFORE INSTALLATION

See mounting template for complete reference to mounting heights and power knockout locations.

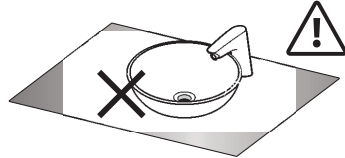
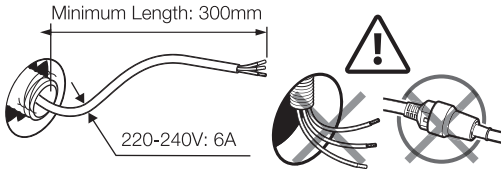

It is recommended to avoid installation of dryer near high reflective objects (mirror, stainless steel washbasins, etc.) in order to avoid errant function of the presence sensor.

INSTALLATION

1

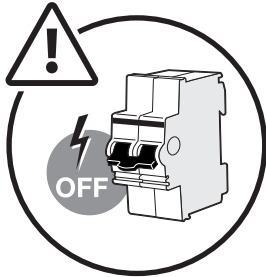

Be sure to break the electric supply before any operation.

2

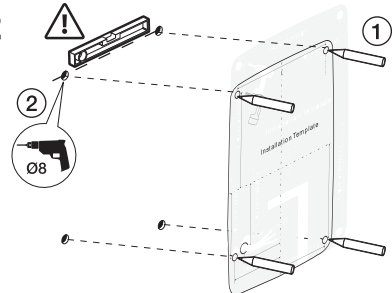

Using the mounting template supplied, mark mounting hole locations for correct height above the floor and drill 4x mounting holes.

3

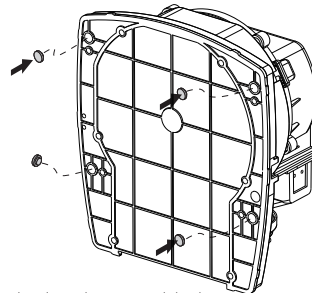
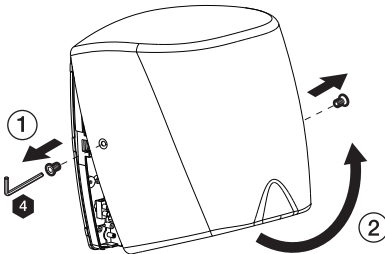

Unscrew front cover from the base of the unit using the hex key provided.

- For in-wall (concealed) power supply: provide supply wire to knockout location according to local code and attach securely to chassis at knockout with appropriate strain relief connector (not supplied).
- For surface mounted conduit (exposed) power supply: provide appropriate conduit to entry location accordingly to local code and attach securely to chassis with correct strain relief connector (not supplied).

4

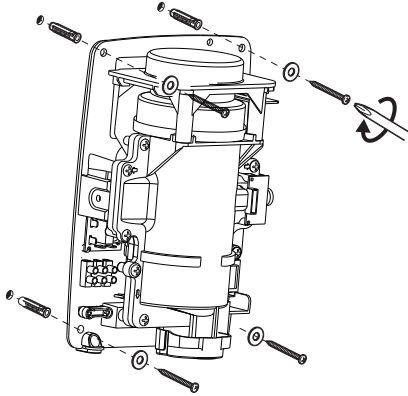

Fix base to the wall.

5

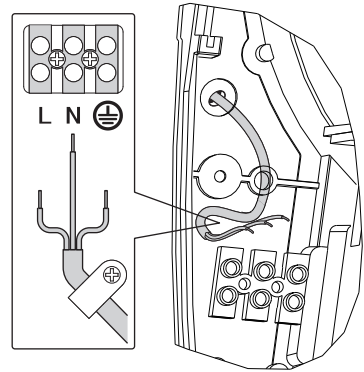

Connect supply and ground wires to terminal block where indicated.

6

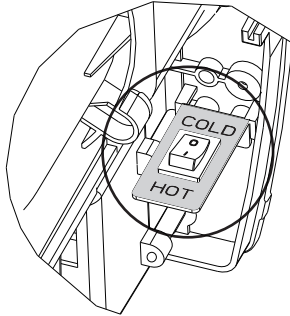
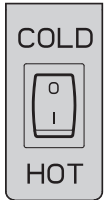

Before replacing cover, there is a customized option to run the dryer heater on (1350 W) or heater off (550 W). The switch is clearly marked.

7

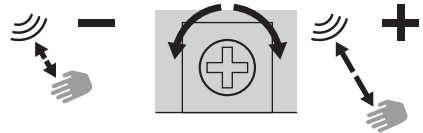
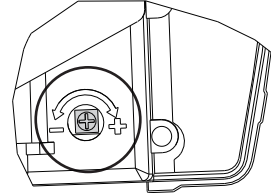

Adjustable detection distance.
Default setting is 120-150mm from nozzle.

8

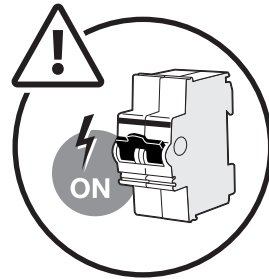
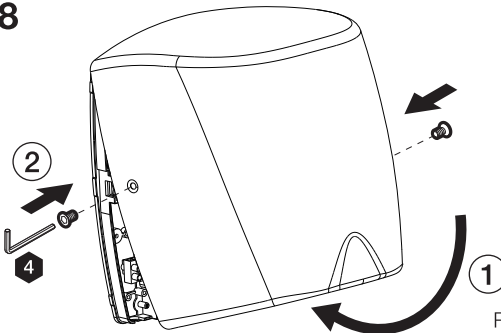

Re-attach the cover to the base of the unit using the hex key provided. Reconnect power supply and test operation.

MAINTENANCE

Periodic cleaning of this unit is required to maintain optimum performance and reduce unnecessary wear on parts. Depending on usage, a regular maintenance programme with a frequency between 3-6 months is highly recommended.

Detach the cover from the dryer and remove any dust or lint. Remove and discard the existing filter (the HEPA filter cannot be cleaned and reused). Replace with a new HEPA filter and reassemble after cleaning.

Wipe the cover with a damp cloth and mild cleaning solution. Do not soak.

Never use abrasives to clean the cover.

WARRANTY

This product is guaranteed by Simx Ltd for 5 years from the date of purchase against faulty materials or workmanship which affects its design ability to switch and operate. During this period if the product has a defect of this nature it will be repaired or replaced free of charge by Simx with the same item, or a similar one of higher specifications, ON THE CONDITIONS THAT:

The buyer returns it to the seller from whom it was bought, freight paid.

The product has been bought by the user, i.e. a receipt/sales invoice is produced as a proof of purchase.

The product has not been misused or handled carelessly, installed in anyway contrary to the installation instruction, or installed in any unusually exposed or harsh environmental conditions.

This guarantee excludes liability for any discolouration or delamination of paint or plastic, or any user replacement parts. It does not confer any rights other than those expressly set out above and does not cover any claims for consequential loss or damage.

Our Goods come with guarantees that cannot be excluded under the Australian and New Zealand Consumer Law. You are entitled to a replacement or refund for a major failure and for compensation for any other reasonably foreseeable loss or damage. You are also entitled to have the Goods repaired or replaced if the Goods fail to be of acceptable quality and the failure does not amount to a major failure.

Specifications are subject to change without notice.



Distributed by Simx (NZ) and Ventair (AUS)

PO Box 14 347, Panmure, Auckland, NZ. Technical Support (09) 259 1662

e: sales@simx.co.nz | www.simx.co.nz | www.ventair.com.au

PUB1729 2205