

# Cavity Fix

Technical Specification  
May 2020 New Zealand



Linea™  
WEATHERBOARD



## We value your feedback!

To continue with the development of our products and systems, we value your input. Please send any suggestions, including your name, contact details, and relevant sketches to:

**Ask James Hardie™**  
[literaturefeedback@jameshardie.co.nz](mailto:literaturefeedback@jameshardie.co.nz)

**Make sure your information is up to date**

When specifying or installing James Hardie products, ensure that you have the current manual. Additional installation information, warranties and warnings are available at [www.jameshardie.co.nz](http://www.jameshardie.co.nz) or **Ask James Hardie™** on **0800 808 868**.

# Contents

<b>1</b>	<b>Product Overview</b>	<b>4</b>	<b>6</b>	<b>Installation</b>	<b>16</b>
1.1	Product Information	4	6.1	Fastener	16
1.2	Manufacturing and Classification	5	6.1.1	Fastener – Size and Method	16
1.3	Components and Accessories	5	6.1.2	Gun Nailing	17
			6.1.3	Fastener Durability	17
<b>2</b>	<b>Application and Scope</b>	<b>9</b>	6.2	Framing	18
2.1	Application	9	6.2.1	Specific Engineering Design (SED)	18
2.2	Scope	9	6.2.2	Gable Ends	18
2.3	Limitations	9	6.2.3	Tolerances	19
2.4	Details	9	6.3	Flexible Underlay or HomeRAB™ Pre-Cladding	19
<b>3</b>	<b>Compliance</b>	<b>10</b>	6.4	Intermediate Support	19
3.1	NZBC Compliance	10	6.5	Rigid Air Barrier	19
<b>4</b>	<b>Design</b>	<b>10</b>	6.6	Vent Strip	19
4.1	Responsibility	10	6.7	Cavity Battens	19
4.2	Clearances	11	6.8	Joints	20
4.3	Structure	11	6.8.1	Jointing	20
4.3.1	Timber Framing	11	6.8.2	Drainage Joint	20
4.3.2	Durability	11	6.8.3	External Corner Joint	20
4.4	Structural Bracing	11	6.8.4	Internal Corner Joint	20
4.5	Energy Efficiency	11	6.9	Junctions and Penetrations	20
4.6	Fire Rated Walls	11			
4.7	Control of External Fire Spread	12	<b>7</b>	<b>Finishes</b>	<b>21</b>
4.8	Alpine regions	12	7.1	Preparation and Priming	21
			7.2	Sealants	21
			7.3	Painting	21
<b>5</b>	<b>Safe Working Practices</b>	<b>13</b>	<b>8</b>	<b>Care and Maintenance</b>	<b>22</b>
5.1	Storage and delivery	15	<b>9</b>	<b>Details Section Index</b>	<b>23</b>
5.2	Tips for safe and easy handling of weatherboard products	16		<b>Product Warranty</b>	<b>51</b>

# 1 Product Overview

## 1.1 Product Information

Linea™ Weatherboard is an external cladding.

Linea Weatherboard is a 16mm thick, pre-primed bevel back fibre cement weatherboard. The bottom front edge of Linea Weatherboard is chamfered. It has tongue and groove ends for jointing and is classified as lightweight wall cladding for use in residential and light commercial buildings using timber or lightweight steel framed external walls. Linea Weatherboard is available in 135mm, 150mm and 180mm widths.

James Hardie also has available:

- Axent™ Fascia is a 16mm thick, pre-primed fibre cement product available in two widths. It's designed to accommodate James Hardie soffit linings.
- Axent™ Trim is a 16mm thick, pre-primed fibre cement product available in two widths. For use as decorative trims around openings and external corners.

For fixing to a steel frame. Ask James Hardie™ on 0800 808 868 for specific requirements. Or refer to the James Hardie cladding to steel framing technical supplement about the installation of Linea Weatherboard to steel frame.

**Table 1**

Linea Weatherboard and Axent Trim sizes							Coverage Information		
Product	Code	Length (mm)	Width (mm)	Thickness (mm)	End details	Effective cover (mm)	No. of planks/ metre height (approx.)	Mass kg/ lineal m (approx. at EMC)	Mass kg/m <sup>2</sup> (approx. at EMC)
Linea Weatherboard 135	401844	4200	135	16	T & G	105	9.5	2.62	25.70
Linea Weatherboard 150	402533	4200	150	16	T & G	120	8.3	3.1	24.93
Linea Weatherboard 180	401847	4200	180	16	T & G	150	6.7	3.57	23.92
Axent Trim 84mm	401943	2600	84	16	Square	N/A	N/A	1.6	N/A
Axent Trim 100mm	401930	2600	100	16	Square	N/A	N/A	1.9	N/A

The effective thickness of finished Linea Weatherboard on the wall at the lap is approximately 33 to 35mm

All dimensions and masses provided are approximate only and are subject to manufacturing tolerances.

Linea Weatherboard is categorised as a Light Weight Wall Cladding as described in the NZS 3604.

## 1.2 Manufacturing and Classification

The manufacturing process of Linea Weatherboard by James Hardie is ISO 9001 Certified.

Linea Weatherboard is an advanced lightweight cement composite cladding manufactured using a basic composition of Portland cement, ground sand, cellulose fibre and water. The product is easily identified by the name 'Linea' printed on the back.

Axent Trim is an advanced lightweight cement composite cladding manufactured using a basic composition of Portland cement, ground sand, cellulose fibre and water. The product is easily identified by the name 'Axent' printed on the back. The trims are factory sealed and primed.









Linea Weatherboard and Axent Trim products are manufactured to Australian/New Zealand Standard AS/NZS 2908.2 'Cellulose-Cement Products' (ISO 8336 'Fibre-Cement Flat Sheet').

Linea Weatherboard is classified Type A, Category 2 in accordance with AS/NZS 2908.2 "Cellulose-Cement Products".




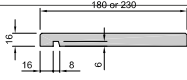





For Safety Data Sheets (SDS) visit [www.jameshardie.co.nz](http://www.jameshardie.co.nz) and view them in the technical literature section or Ask James Hardie on **0800 808 868**.

## 1.3 Components and Accessories

Table 2

Accessories/tools supplied by James Hardie			
Accessories	Description	Size (mm)	Code
	<b>External corner soaker 90° for Linea Weatherboards 180mm</b> <ul style="list-style-type: none"> <li>Aluminium</li> <li>Copper</li> <li>Stainless Steel</li> </ul>	200 long	<b>301186</b> <b>301188</b> <b>301197</b>
	<b>External corner soaker 135° for Linea Weatherboards 180mm</b> <ul style="list-style-type: none"> <li>Aluminium</li> </ul>	200 long	<b>301178</b>
	<b>External corner soaker 90° for Linea Weatherboards 150mm</b> <ul style="list-style-type: none"> <li>Aluminium</li> <li>Stainless Steel</li> </ul>	170 long	<b>302820</b> <b>302821</b>
	<b>External corner soaker 90° for Linea Weatherboards 135mm</b> <ul style="list-style-type: none"> <li>Aluminium</li> <li>Stainless Steel</li> </ul>	155 long	<b>301185</b> <b>301196</b>
	<b>External Slimline Box Corner Mould</b> Etched primed aluminium extrusion used to create external corner	2700 long 4000 long	<b>301195</b> <b>305809</b>
	<b>Linea 35mm Cavity Closer</b>	3000 long	<b>306035</b>
	<b>Internal 'W' Mould 90°</b> Etched primed aluminium extrusion used to create 90° internal corner	2700 long 4000 long	<b>301184</b> <b>305807</b>
	<b>Internal 'W' Mould 135°</b> Etched primed aluminium extrusion used to create 135° internal corner	2700 long	<b>301183</b>
Accessories/tools supplied by James Hardie			

**Table 2 contd.**

Accessories	Description	Size (mm)	Code
	<b>JH Corner Under Flashing 50 x 50mm</b> PVC moulding used as under fashing for internal and external corners	3000 long	<b>303745</b>
	<b>Axent Trim 84mm</b>	84 x 2600 long	<b>401943</b>
	<b>Axent Trim 100mm</b>	100 x 2600 long	<b>401930</b>
	<b>Axent Fascia</b> - 180mm - 230mm	4200 long	<b>401843</b> <b>402230</b>
	<b>HardieFlex™ Galvanised nail - 5kg</b>	60 x 3.15mm	<b>302784</b>
	<b>HardieFlex™ Stainless steel nail - 5kg</b>	60 x 3.15mm	<b>302782</b>
	<b>HardieBlade™ Saw Blade</b> Diamond tip fibre cement circular saw blade. Spacers not included	4 tooth - 184mm	<b>300660</b>
	<b>HardieBlade™ Saw Blade</b> Diamond tip fibre cement circular saw blade. Spacers not included	6 tooth - 254mm	<b>303375</b>
	<b>Gecko Gauge</b> This easy to use tool gauges and supports the weatherboard for a one person install.		<b>305941</b>

**Table 3**

**Accessories not supplied by James Hardie**

James Hardie recommends the following products for use in conjunction with its Linea Weatherboard and Axent Trim. James Hardie does not supply these products. There may also be some other accessories required depending upon the application. Please contact component manufacturer for information on their warranties and further information on their products.


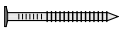






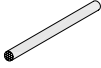



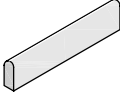



<b>Accessories</b>	<b>Description</b>	<b>Size (mm)</b>	<b>Material/ appearance</b>
	<b>Flexible Underlay</b> To comply with Table 23 of E2/AS1		
	<b>D head or RounDrive Nail</b> Gun nail for concealed fixing Linea Weatherboard.	60 x 2.87	Hot Dip Galvanised/ Stainless Steel
	<b>HardieFlex™ Hot Dip Galv. Nails</b> For concealed fixing by hand nail	60 x 3.15mm 75 x 3.15mm	Hot Dip Galvanised/ Stainless Steel
	<b>Jolt Head Nail</b> for face fixing Linea Weatherboard	75 x 3.15mm 90 x 3.55mm	Hot Dip Galvanised/ Stainless Steel
	<b>Titanium Coated High Speed Drill Bit.</b> For pre-drilling prior to face fixing with jolt head.	3.0mm 3.5mm	
	<b>Brad Nail</b> To tie boards together	32mm	
	<b>Joint sealant</b> Paintable flexible sealants are recommended for filling the joints. Refer to Section 7.2 for information.	Tube	Sika, Bostik or similar Holdfast
	<b>CRC ADOS Builders Fill</b> Two part exterior grade fill to finish over jolt head nails.		
	<b>PEF Rod</b>	Polyethylene foam	Sika or similar
	<b>Flexible tape</b> A flexible self-adhesive tape used in preparation of a window. Refer to the Window installation section in this manual for more information.	Proprietary tape to adhere to flexible underlay	Tyvek, Marshall Innovations or similar
	<b>Flashing Material</b> as per Table 20, 'E2/AS1'		Flashing Fabricator
Dimension to suit 	<b>Planted Sill</b>		H3.1 minimum Treated Timber Timber Merchant or cut on site

Table 3 contd.

Accessories not supplied by James Hardie			
Accessories	Description	Size (mm)	Material/ appearance
	<b>Timber Scribe</b> To scribe beside window, site cut to suit.	As required	H3.1 minimum Treated Timber Timber Merchant or cut on site
	<b>Fibre Cement Cutting Blade</b> Diamond tip 305mm diameter circular saw blade to fit drop saw.	305mm	Diamond Tipped
	<b>Cavity Closer - aluminium</b> Used in walls taller than 10m for inter-tenancy fire separation.		
	Primers. Dulux 1-Step Prep, Resene Quick Dry etc.		



# 2 Application and Scope

## 2.1 Application

This specification includes the installation of Linea Weatherboard cavity construction where risk matrix is 13 or more and must be read in conjunction with the current CodeMark Certificate and BRANZ Appraisal. This installation method can also be used for buildings where the risk matrix score is 0 - 12 if desired.

This document is intended for use by architects, designers, specifiers or builders who are involved in specifying Linea Weatherboard. The document also serves the purpose of an installation manual for this product.

For use of Linea Weatherboard outside this published scope, the architect, designer or engineer must undertake specific design. For advice on designs outside the scope of this specification, Ask James Hardie on 0800 808 868.

Refer to the Linea Weatherboard Direct Fixed Technical Specification when installing Linea Weatherboard without a cavity.

## 2.2 Scope

Linea Weatherboard cavity construction is suitable for use in timber framed buildings that fall within the scope limitations of the New Zealand Building Code (NZBC) Acceptable Solution E2/AS1, Paragraph 1.1.

Linea Weatherboard cavity construction is also suitable for use in specific engineering design projects (SED) subject to a wind pressure of 2.5kPa (ULS) maximum for building heights upto 25m.

## 2.3 Limitations

- Linea Weatherboard cladding must not be used on curved wall applications
- Linea Weatherboard cladding must not be installed vertically or angled
- The minimum ground clearances specified must be maintained
- Timber window joinery/recessed openings is subject to an alternative design by the designer
- Maximum SLS inter-story seismic deflections up to span/180 when used in specific design buildings (SED) buildings above 10m height. To accommodate higher inter-story drifts, a deflection should be used.

## 2.4 Details

Various typical Linea Weatherboard details are provided within this document. In addition to these, the construction details with HomeRAB™ Pre-Cladding/RAB™ Board have also been developed and are available on our website. These details are available in dwg, dxf, jpg and pdf file format and can be downloaded at [www.jameshardie.co.nz](http://www.jameshardie.co.nz).

All dimensions shown are in millimetres unless noted otherwise.

# 3 Compliance

## 3.1 NZBC Compliance

When installed in accordance with the conditions of CodeMark number GM-CM30018 Linea Weatherboard complies with all relevant requirements of the NZBC.



Please refer to [www.building.govt.nz](http://www.building.govt.nz) for a copy of the certificate.

Linea Weatherboard cavity fixed cladding also has a BRANZ Appraisal number 447 (2010) available at [www.branz.co.nz](http://www.branz.co.nz) or [www.jameshardie.co.nz](http://www.jameshardie.co.nz).



# 4 Design

## 4.1 Responsibility

The specifier or other party responsible for the project must ensure that the information and details in this specification are appropriate for the intended application and that additional detailing is performed for specific design or any areas that fall outside the scope of this technical specification.

All New Zealand Standards referenced in this manual are current edition and must be complied with.

### Specifier

If you are a specifier or other responsible party for a project ensure that the information in this document is appropriate for the application you are planning and that you undertake specific design and detailing for areas which fall outside the scope of these specifications.

### Installer

If you are an installer ensure that you follow the design, moisture management principles, associated figures and material selection provided by the designer and this James Hardie Technical Specification. All the details provided in this document must be read in conjunction with the project specification.

**James Hardie conducts stringent quality checks to ensure that any product manufactured falls within our quality spectrum. It is the responsibility of the builder to ensure that the product meets their aesthetic expectations before installation. James Hardie will not be responsible for rectifying obvious aesthetic surface variations following installation. James Hardie will only offer a replacement product if Linea Weatherboard or Axent Trim supplied are found to be out of its manufacturing specification.**

## 4.2 Clearances

The clearance between the bottom edge of cladding and the paved/unpaved ground must comply with section 9.1.3 of E2/AS1. On the roofs and decks the minimum clearance must be 50mm. These clearances must be maintained throughout the life of the building.

Linea Weatherboard must overhang the bottom plate on a concrete slab by a minimum of 50mm as required by the NZBC Acceptable Solution, E2/AS1 Table 18.

The site on which the building is situated must comply with the NZBC Acceptable Solution E1/AS1 'Surface Water'.

Do not install cladding such that it may remain in contact with water or ground, refer to figures in section 9 of this manual.

## 4.3 Structure

### 4.3.1 Timber Framing

Timber framing must be in accordance with NZS 3604 (Timber-framed buildings) or designed as for specific engineering design (SED) in accordance with NZS 3603 and AS/NZS 1170 where specific engineering design is required, the framing stiffness must be equivalent to or more than the framing provisions of NZS 3604.

The stud spacing must not exceed 600mm centres maximum for buildings within the scope of NZS 3604 and 400mm centres maximum for wind pressures more than 1.5kPa (ULS).

For timber frame walls longer than 12m, it is best practice to allow for construction joints to accommodate movements generated due to timber shrinkage or deflections.

### 4.3.2 Durability

Timber framing must be treated to a minimum H1.2 treatment requirements and comply with Acceptable Solution B2/AS1 'Durability' of the NZBC. For further timber treatment information refer to the NZS 3602 (Timber and Wood-Based Products for use in Buildings) for minimum timber treatment selection and treatment requirements. Framing must be protected from moisture at sites in accordance with the recommendations of framing manufacturers. Refer to the NZS 3602 for information about the allowable moisture content in timber framing.

## 4.4 Structural Bracing

Bracing can be achieved by using HomeRAB™ Pre-Cladding or RAB™ Board installed direct to framing instead of a flexible underlay or by using Villaboard™ Lining bracing system on the internal face.

## 4.5 Energy Efficiency

External walls constructed as per this technical specification, using Linea Weatherboard cladding must use suitable bulk insulation to meet the minimum thermal insulation requirements as per Clause H1/AS1 'Energy Efficiency' of the NZBC.

## 4.6 Fire Rated Walls

External walls with Linea Weatherboard cavity fix construction method can achieve fire ratings up to 60/60/60 when constructed in accordance with the James Hardie Fire and Acoustic Design Manual. Linea Weatherboard must be face fixed for fire rated applications.

Refer to the Fire and Acoustic Design Manual for further information about fire rated systems.

## 4.7 Control of External Fire Spread

External spread of fire (clause C3.5 and C3.7) apply where:

- Building height is greater than 10m and upper floors have sleeping uses or are different property (C3.5), and
- Where the building is located within 1m of a relevant boundary (C3.7)

Refer to Table 5.1 of Section 5.4 of C/AS1 for group SH or table 5.5 of Section 5.8.1 of C/AS2 for the other risk groups to identify the external fire spread requirement applicable to the external cladding material and surface finish.

For the other situations where 'no requirement' is listed, Linea Weatherboard installed as per the details published in this specification complies.

For buildings that are >10m high and contain tenancies above as per Table 5.5. of C/AS2, Linea Weatherboard installed over timber cavity battens in conjunction with RAB™ Board with R2.2 fibreglass/James Hardie mineral insulation complies. Refer to Figure 38 and 39 for RAB™ Board and cavity batten layout. For the complete set of suitable Linea Weatherboard cavity construction details with RAB™ Board for this application, refer to [www.jameshardie.co.nz](http://www.jameshardie.co.nz).

## 4.8 Alpine regions

In regions subject to freeze/thaw conditions, Linea Weatherboard must not be in direct contact with snow or ice build up for extended periods, e.g. external walls in alpine regions subject to snow drifts over winter.

The Linea Weatherboard has been tested in accordance with AS/NZS 2908.2 Clause 8.2.3.

# 5 Safe Working Practices

## **WARNING - DO NOT BREATHE DUST AND CUT ONLY IN WELL VENTILATED AREA**

**James Hardie products contain sand, a source of respirable crystalline silica may cause cancer if dust from product is inhaled. Causes damage to lungs and respiratory system through prolonged or repeated inhalation of dust from product.**

Intact fibre cement products are not expected to result in any adverse toxic effects. The hazard associated with fibre cement arises from the respirable crystalline silica present in dust generated by activities such as cutting, rebating, drilling, routing, sawing, crushing, or otherwise abrading fibre cement, and when cleaning up, disposing of or moving dust.

When doing any of these activities in a manner that generates dust, follow James Hardie instructions and best practices to reduce or limit the release of dust.

If using a dust mask or respirator, use an AS/NZS1716 P1 filter and refer to Australian/New Zealand Standard 1715:2009 Selection, Use and Maintenance of Respiratory Protective Equipment for more extensive guidance and more options for selecting respirators for workplaces. For further information, refer to our installation instructions and Safety Data Sheets available at [www.jameshardie.co.nz](http://www.jameshardie.co.nz).

**FAILURE TO ADHERE TO OUR WARNINGS, SAFETY DATA SHEETS, AND INSTALLATION INSTRUCTIONS MAY LEAD TO SERIOUS PERSONAL INJURY OR DEATH.**

### **Crystalline Silica is**

- Commonly known as sand or quartz
- Found in many building products e.g. concrete, bricks, grout, wallboard, ceramic tiles, and all fibre cement materials

### **Why is Crystalline Silica a health hazard?**

- Silica can be breathed deep into the lungs when present in the air as a very fine (respirable) dust
- Exposure to silica dust without taking the appropriate safety measures to minimise the amount being breathed in, can lead to a potentially fatal lung disease – silicosis – and has also been linked with other diseases including cancer. Some studies suggest that smoking may increase these risks
- The most hazardous dust is the dust you cannot see!

### **When is Crystalline Silica a health hazard?**

- It's dangerous to health if safety protocols to control dust are not followed when cutting, drilling or rebating a product containing crystalline silica and when cleaning up
- Products containing silica are harmless if intact (e.g. an un-cut sheet of wall board)

### **Avoid breathing in crystalline silica dust**

#### **Safe working practices**

- ✗ NEVER use a power saw indoors or in a poorly ventilated area
- ✗ NEVER dry sweep
- ✓ ALWAYS use M Class or higher vacuum or damp down dust before sweeping up
- ✗ NEVER use grinders
- ✓ ALWAYS use a dust reducing circular saw equipped with a sawblade specifically designed to minimise dust creation when cutting fibre cement – preferably a sawblade that carries the HardieBlade™ logo or one with at least equivalent performance – connected to an M Class or higher vacuum

- ✓ Before cutting warn others in the area to avoid dust
- ✓ ALWAYS follow tool manufacturers' safety recommendations
- ✓ ALWAYS expose only the minimum required depth of blade for the thickness of fibre cement to be cut
- ✓ ALWAYS wear a properly-fitted, approved dust mask or respirator P1 or higher in accordance with applicable government regulations and manufacturer instructions
- ✓ Consider rotating personnel across cutting tasks to further limit respirable silica exposures.

### **When cutting**

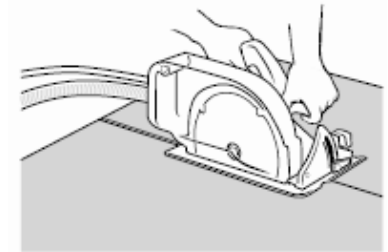
- ✓ Work outdoors only
- ✓ Make sure you work in a well ventilated area
- ✓ Position cutting station so wind will blow dust away from yourself and others in the working area
- ✓ Rotate employees across cutting task over duration of shift
- ✓ Cut products with a HardieBlade Saw Blade (or equivalent) and a dust reducing circular saw connected to a M Class or higher vacuum
- ✓ When sawing, sanding, rebating, drilling or machining fibre cement products, always:
  - Wear your P1 or higher (correctly fitted in accordance with manufacturers' instructions), ask others to do the same.
  - Keep persons on site at least 2 metres and as far as practicable away from the cutting station while the saw is in operation
  - If you are not clean shaven, then use a powered air respirator with a loose fitting head top
  - Wear safety glasses
  - Wear hearing protection
- ✓ Make sure you clean up BUT never dry sweep. Always hose down with water/wet wipe or use an M Class or higher vacuum

**If concern still exists about exposure levels or you do not comply with the above practices, you should always consult a qualified industrial hygienist or contact James Hardie for further information.**

## Working Instructions

### HardieBlade™ Saw Blade

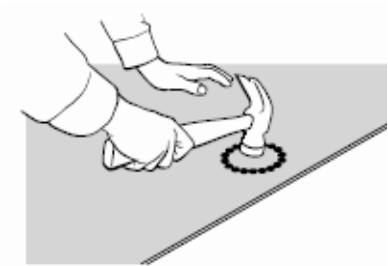
The HardieBlade Saw Blade used with a dust-reducing saw is ideal for fast, clean cutting of James Hardie fibre cement products. A dust-reducing saw uses a dust collector connected to a M Class or higher vacuum. When sawing, clamp a straight edge to the sheet as a guide and run the saw base plate along the straight edge when making the cut.



### Hole-Forming

#### For smooth clean cut circular holes:

- Mark the centre of the hole on the sheet
- Pre-drill a 'pilot' hole
- Using the pilot hole as a guide, cut the hole to the appropriate diameter with a hole saw fitted to a heavy duty electric drill



#### For irregular holes:

- Small rectangular or circular holes can be cut by drilling a series of small holes around the perimeter of the hole then tapping out the waste piece from the sheet face
- Tap carefully to avoid damage to sheets, ensuring that the sheet edges are properly supported

## 5.1 Storage and delivery

Keeping products and people safe

### Off loading

- ✓ James Hardie products should be off-loaded carefully by hand or by forklift
- ✓ James Hardie products should not be rolled or dumped off a truck during the delivery to the jobsite

### Storage

James Hardie products should be stored:

- ✓ In their original packaging
- ✓ Under cover where possible or otherwise protected with a waterproof covering to keep products dry
- ✓ Off the ground – either on a pallet or adequately supported on timber or other spacers
- ✓ Flat so as to minimise bending

James Hardie products must not be stored:

- ✗ Directly on the ground
- ✗ In the open air exposed to the elements

**James Hardie is not responsible for damage due to improper storage and handling.**

## 5.2 Tips for safe and easy handling of weatherboard products

### Weatherboard products

- ✘ Do not lift planked products flat and in the middle
- ✓ Carry the products on the edge
- ✓ If only one person is carrying the product, hold it in the middle and spread arms apart to better support the product
- ✓ If two people are carrying the plank, hold it near each end and on edge
- ✓ Exercise care when handling weatherboard products to avoid damaging the edges/corners

# 6 Installation

The horizontal lap between the two Linea Weatherboard must be 30mm minimum. In certain scenarios you may require to creep up the lap, this must not exceed 33mm.

Linea Weatherboard must be kept dry whilst in storage prior to and during fixing. Site cut ends that are exposed such as slimline box corners, internal corners etc. and any sanded patches on the boards surface must be primed prior to installation. Dust and loose material must be removed before priming.

## 6.1 Fastener

### 6.1.1 Fastener – Size and Method

Linea Weatherboard and Axent Trim must be fixed to timber with the types of nails specified in Tables 4 and 5, in accordance with the following requirements:

- Linea Weatherboard can either be face/exposed fixed or concealed fixed
- Linea Weatherboard must be fixed into studs at maximum 600mm centres. Fixing centres to coincide with stud spacing, refer to figures in section 9 of this manual
- All concealed nails must be driven flush with the board surface
- When concealed fixing Linea Weatherboard, nails must be driven under the lap of boards, except at all corners and vertical edges of openings where Linea Weatherboard must be face fixed, refer to figures in section 9 of this manual
- Nails must be fixed 25mm from the end of the board when hand nailing. For gun nailing refer to Section 6.1.2
- When using concealed fixing method, any gaps that may appear under the lap due to site conditions can be minimised by fixing a jolt head nail through the lap as per the exposed nailing method. Refer to figures in section 9 of this manual
- When using concealed fixing method, Linea Weatherboard may be tied together by face fixing through the lap using a 32mm brad nail if desired.
- When face fixing Linea Weatherboard, the upper board must be pre-drilled before fixing with a jolt head nail



**Table 4**

Wind pressure (kPa)	Underlay	Fixing method	Fixing type	Instructions
Up to 1.5 (up to and including VH Wind Zone)	Flexible underlay	Concealed nailing	60 x 3.15mm HardieFlex™ nail or a 60 x 2.87mm D/round head gun nail	Finish flush with the board surface.
		Face nailing	75 x 3.15mm jolt head nails	Hot-dipped galvanised/stainless steel jolt head nail with pre-drilling through the top weatherboard. Use a 3mm drill bit.
	Rigid air barrier	Concealed nailing	75 x 3.15mm HardieFlex™ nail or a 75 x 3.06mm D/round head gun nail	Finish flush with the board surface.
		Face nailing	90 x 3.55mm jolt head nails	Hot-dipped galvanised/stainless steel jolt head nail with pre-drilling through the top weatherboard. Use a 3.5mm drill bit.
1.5 to 2.5 (EH Wind Zone and SED projects)	RAB™ Board	Face nailing	90 x 3.55mm jolt head nail	Hot-dipped galvanised/stainless steel jolt head nail with pre-drilling through the top weatherboard. Use a 3.5mm drill bit.

**Table 5**

Nail requirements for Axent Trim	
Single thickness	60mm jolt head nails.  If fixing over Linea Weatherboard use 75 x 3.15mm jolt head nails through a pre-drilled hole, using a 3mm drill bit.
Single thickness plus packer	If fixing over Linea Weatherboard use 75 x 3.15mm jolt head nails through a pre-drilled hole, using a 3mm drill bit.  When fixing to timber support use 60mm jolt head nails.

For fire rated wall applications the Linea Weatherboards must be face fixed. For more information Ask James Hardie on 0800 808 868.

### 6.1.2 Gun Nailing

Linea Weatherboard can be gun nailed with a D-Head or RounDrive nail when concealed fixing method is used.

- Nails must be no closer than 50mm from the ends of boards when gun nailing is used, double studs will be required.
- Be minimum length and nearest gauge as per Table 4.
- Be finished flush with surface of board.

### 6.1.3 Fastener Durability

Fasteners must meet the minimum durability requirements of the NZBC. Refer to Table 6 for fixing materials requirements to be used in relation to the exposure conditions.

**Table 6**

Exposure conditions and nail selection prescribed by NZS 3604		
Zone	Application	
D (sea spray) and geothermal hot spots	General	Stainless steel 304/316
	Fire	
*C and B	General	Hot dip galvanised**
	Fire	

\* Zone C areas where local knowledge dictates that increased durability is required, appropriate selection shall be made. Microclimatic conditions as detailed in NZS 3604, Paragraph 4.2.4 require SED.

\*\*Hot dip galvanised must comply with AS/NZS 4680.

Also refer to the NZBC Acceptable Solution E2/AS1 Table 20 and 21 for information regarding the selection of suitable fixing materials and their compatibility with other materials.

## 6.2 Framing

Framing to be in accordance with the NZS 3604. The following must be provided for fixing Linea Weatherboard:

- Studs at 600mm centres maximum for all wind speed zones up to and including very high (VH)
- Studs at 400mm centres maximum for wind pressures more than 1.5 kPa (ULS)
- Double studs are required at internal corners
- Extra packers may be required at external corners
- Extra studs are required for aluminium internal corner sections

### 6.2.1 Specific Engineering Design (SED)

For EH wind zone and specific engineering design projects the timber framing is required to be designed in accordance with NZS 3603 and AS/NZS 1170. The minimum framing sizes and layout must comply with this specification:

- Stud spacing 400mm centres maximum
- Nog spacing 1200mm centres maximum
- Double studs are required at internal corners
- Extra packers may be required at external corners
- Extra studs are required for aluminium internal corner sections

### 6.2.2 Gable Ends

In case of gable end trusses sitting on top plates of the external wall frame, the frame size must be in accordance with truss design and specification supplied by the frame and truss manufacturer/supplier supported by independent design producer statement.

### 6.2.3 Tolerances

In order to achieve an acceptable wall finish, it is imperative that framing is straight and true. Framing tolerances must comply with the requirements of NZS 3604 and the manufacturer's specifications. All framing must be made flush. The visual aspects of the finished cladding can differ between two different sites or the builders installing the product. It is recommended that you also refer to a building guidance document published by MBIE to understand an acceptable level of tolerances allowed in building materials and workmanship. [www.building.govt.nz](http://www.building.govt.nz) Guide to tolerances, materials and workmanship in new residential construction 2015

## 6.3 Flexible Underlay or HomeRAB™ Pre-Cladding

Flexible underlay or HomeRAB™ Pre-Cladding must be provided to comply with the requirements of E2/AS1 up to and including very high wind zone.

Walls which are not lined on the inside face (e.g. garage walls or gable ends) must include a rigid sheathing or an air barrier behind the cladding. HomeRAB™ Pre-Cladding is suitable for use as an air barrier and must be installed in accordance with HomeRAB™ Pre-Cladding and RAB™ Board Installation Manual.

## 6.4 Intermediate Support

Where studs are at 600mm centres an intermediate means of restraining the flexible underlay and insulation from bulging into the cavity must be installed. An acceptable method to achieve this is using one of the following:

- Intermediate cavity batten between the studs; or
- 75mm galvanised mesh; or
- Polypropylene tape at 300mm centres fixed horizontally and drawn taut.

No intermediate supports are required:

- Where studs are at maximum 400mm centres; or,
- When rigid sheathings instead of flexible underlays are used.

## 6.5 Rigid Air Barrier

In EH wind zone or for specific design wind zone, a rigid air barrier i.e. RAB™ Board, must be used instead of flexible underlay.

For buildings more than 10m, RAB™ Board must be used. To achieve the temporary weathertightness using HomeRAB™ Pre-Cladding and RAB™ Board, windows/doors need to be installed with required flashing tapes and seals etc. Refer to HomeRAB™ Pre-Cladding and RAB™ Board Installation Manual for information regarding its installation and to achieve temporary weathertightness.

## 6.6 Vent Strip

Linea 35mm cavity closer vent strip (uPVC) must be installed at the bottom of all walls constructed using the drained and ventilated for cavity construction method. James Hardie Linea 35mm cavity closer vent strip has an opening area of 1000mm<sup>2</sup>/m length. It is important that the openings in the vent strip are kept clear and unobstructed to allow free drainage and ventilation of cavities. Alternate cavity closer can be used ensuring compliance of E2 and may need to be used with a cant strip.

## 6.7 Cavity Battens

The cavity battens provide airspace between the frame and cladding and are considered a “packer” only in this specification.

The timber battens must be minimum H3.1 treated to comply with the durability requirements of B2/AS1.

Cavity battens must comply with E2/AS1 and:

- Be minimum 18mm thick
- Be minimum 45mm wide
- Until claddings are fixed the battens need only to be tacked to framing with 40 x 2.8mm nails at 800mm centres maximum (batten fixing is required temporarily to keep them straight on the wall during construction)

## 6.8 Joints

### 6.8.1 Jointing

The ends of Linea Weatherboard are jointed off-stud by means of a tongue and groove joint. Tongue and groove joints may be located centrally between studs but no closer than 100mm from the edge of a stud. The joints must be staggered by 600mm minimum. Flexible sealant must be applied to the front of tongue before pushing into the groove at the time of installation. From a visual perspective, the joint line will be visible and must not be hard filled.

### 6.8.2 Drainage Joint

After every two floors a horizontal drainage joint flashing is required, refer to figures Figure 29 in section 9 of this manual.

### 6.8.3 External Corner Joint

There are a number of options to select from when detailing external corners:

- 90° corner soaker in aluminium, copper or stainless steel
- 135° corner soaker 180mm aluminium
- Aluminium boxed corners
- Box corners using Axent Trim
- Mitred corners to weatherboards

Refer to figures in section 9 of this manual.

### 6.8.4 Internal Corner Joint

There are a number of options to select from when detailing internal corners:

- 90° or 135° Aluminium W-mould
- Scribed corner

Refer to figures in section 9 of this manual.

## 6.9 Junctions and Penetrations

All windows and doors must be detailed as per the requirements of this specification. James Hardie has developed the window details for Linea Weatherboard which meet the performance requirements of E2 'External Moisture', an approved document of the NZBC, refer to figures in section 9 of this manual.

# 7 Finishes

Protective coating of Linea Weatherboard and Axent Trim is required in order to meet the durability requirements of the NZBC.

## 7.1 Preparation and Priming

The Linea Weatherboard and Axent Trim must be dry before painting. Punch and fill all exposed nails a maximum of 2mm below the surface. Fill the hole with an exterior grade 2 part builders fill, eg CRC ADOS Builders Fill, allow to cure and using 60 grit sand paper smooth ready for painting. Prime any sanded patch on board surface or the site cut edges that will be exposed.

It is not recommended to seal gap under the lap of weatherboards as it helps in circulation of air behind the weatherboard cladding. However if sealing of the gap is undertaken, the product warranty still applies.

## 7.2 Sealants

All sealants must demonstrate the ability to meet the relevant requirements of the NZBC. Application and use of sealants must comply with manufacturer's instructions. Sealants, if coated, must be compatible with the paint system.

## 7.3 Painting

All Linea Weatherboards are pre-primed on their face and bottom edge with a factory applied acrylic base coat.

Linea Weatherboard and Axent Trim must be painted within 90 days of installation. Dark coloured paints can be used, i.e. there is no restriction on the Light Reflectance Value (LRV) of paint to be applied. All exposed faces, including the top edges under the sills and bottom edges of Linea Weatherboard, Axent Trim and accessories must be finished with an exterior paint system.

For best aesthetic results a low sheen paint is recommended.

The dark colours in certain environments may fade over a period of time. Special paints/coatings are required in certain harsh environments.

Stainless steel soakers are generally left natural. For painting over stainless steel soakers, refer to paint manufacturer as special preparation and paints are required.

Paint selection and the preparation required is dependent on paint chosen. Refer to the paint manufacturer for information before starting painting.

# 8 Care and Maintenance

The extent and nature of maintenance will depend on the geographical location and exposure of the building. It is the responsibility of the specifier to determine normal maintenance requirements to comply with the NZBC Acceptable Solution B2/AS1. As a guide, it is recommended that basic normal maintenance tasks shall include but not be limited to:

- Washing down exterior surfaces every 6-12 months\* using low pressure water and a brush, and every 3-4 months in extreme coastal conditions or sea spray zones
- Re-coating exterior protective finishes. Always refer to your paint manufacturer for re-coating requirements
- Maintaining the exterior envelope and connections including junctions, penetrations, flashings and sealants
- Cleaning out gutters, blocked pipes and overflow pipes as required
- Pruning back vegetation close to or touching the building as well as ensuring the NZBC ground clearance requirements are maintained especially where gardens are concerned
- The clearances between the bottom edge of Linea Weatherboard and the finished/unfinished ground must always be maintained
- Stainless steel soakers used in extreme coastal conditions or in sea spray zones may show some signs of 'tea staining'. It is an aesthetic issue and to minimise staining soaker must be washed/polished frequently

\*Do not use a water blaster to wash down the cladding. Refer to your paint manufacturer for washing down requirements.

# 9 Details Section Index

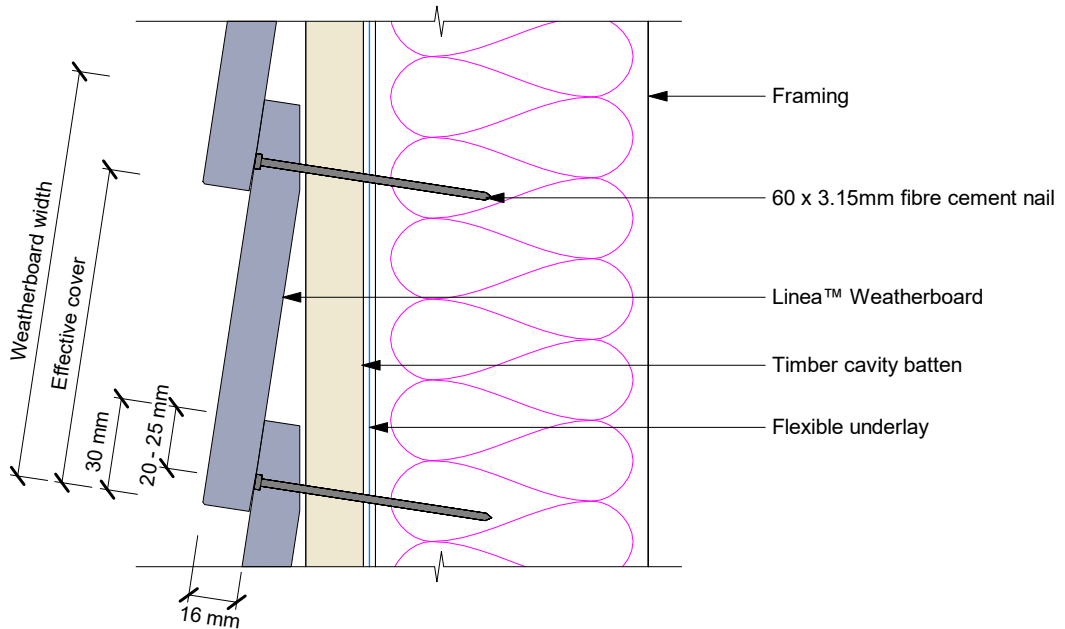
<b>Description</b>	<b>Page</b>
Figure 1: Weatherboard fixing	25
Figure 2: Batten fixing	26
Figure 3: Batten layout at window opening	26
Figure 4: Foundation detail	27
Figure 5: Enclosed Deck	27
Figure 6: Jointing off stud	28
Figure 7: External corner soaker	28
Figure 8: Aluminium box corner	29
Figure 9: Boxed corner	29
Figure 10: Mitre corner	30
Figure 11: Internal 90 ° aluminium 'W' mould corner	30
Figure 12: Internal 135 ° aluminium 'W' mould corner	31
Figure 13: Internal corner joint flashing	31
Figure 14: Wall to soffit junction 'X'	32
Figure 15: Nil soffit detail	32
Figure 16: Sloping soffit and wall junction	33
Figure 17: Window and door sill	33
Figure 18: Window head	34
Figure 19: Window jamb	34
Figure 20: Window head stop end	35
Figure 21: Window sill with facing	36
Figure 22: Window head with facings	36
Figure 23: Window jamb with facings	37
Figure 24: Door sill support detail	37
Figure 25: Pipe penetration	38
Figure 26: Continuous cladding over joist	38
Figure 27: Drained flashing joint at floor level	39
Figure 28: Timber deck junction	39
Figure 29: One piece apron flashing joint	40
Figure 30: Roof to wall junction detail	40
Figure 31: Parapet flashing	41
Figure 32: Enclosed deck balustrade to wall	41
Figure 33: Enclosed balustrade to wall	42
Figure 34: Junction Linea™ Weatherboard and fascia board	43

<b>Description</b>	<b>Page</b>
Figure 35: Enclosed roof to wall intersection	44
Figure 36: Garage door head	45
Figure 37: Garage door jamb	45
Figure 38: Framing setout building height over 10m	46
Figure 39: Intertenancy vertical fire separation	47

For all meter box details please visit our website at [www.jameshardie.co.nz](http://www.jameshardie.co.nz) or Ask James Hardie on **0800 808 868**.

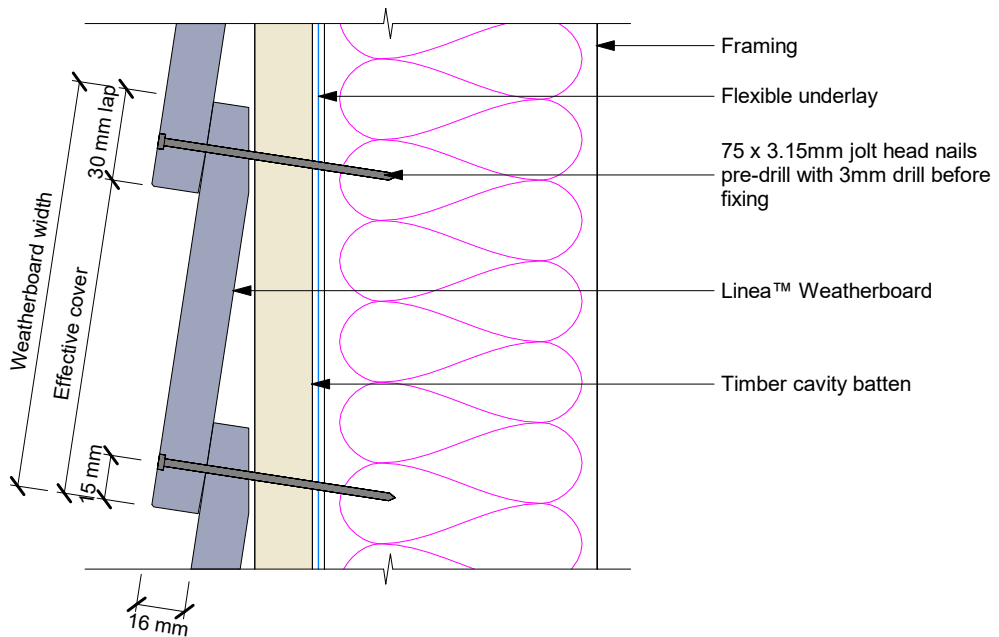


**Figure 1: Weatherboard fixing**



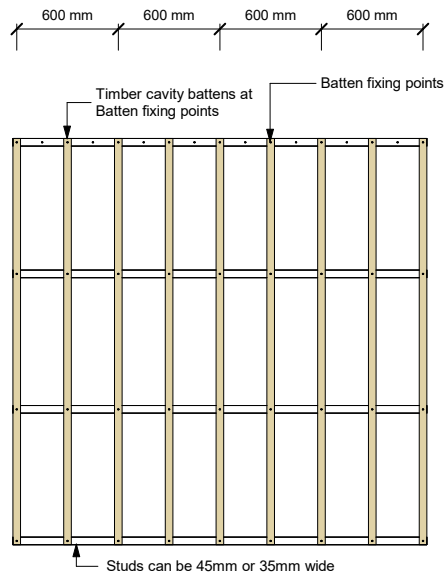
**Concealed Nailing**

Linea™ Weatherboards to be face fixed at corners and down window and door openings using jolt head nails at 90° to face, punch 2mm below surface and fill. Refer to fixing table 4



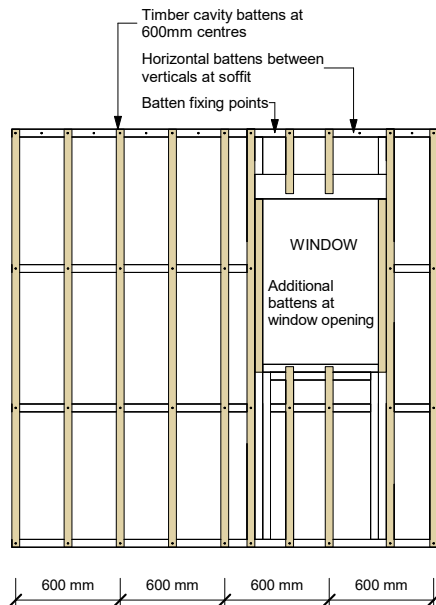
**Exposed Nailing**

**Figure 2: Batten fixing**



The intermediate support for insulation between the studs could be a timber cavity batten, polypropylene tape or 75 mm galvanised wire mesh. Refer to E2/AS1 Paragraph 9.1.8.5 Polypropylene tape must be fixed horizontally and drawn taut at 300 mm centres.

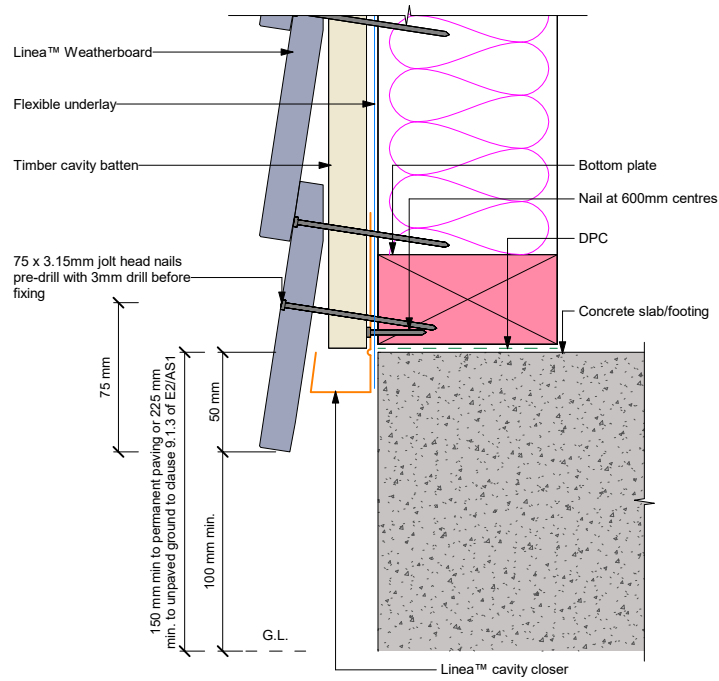
**Figure 3: Batten layout at window opening**



- Studs can be 45mm or 35mm wide

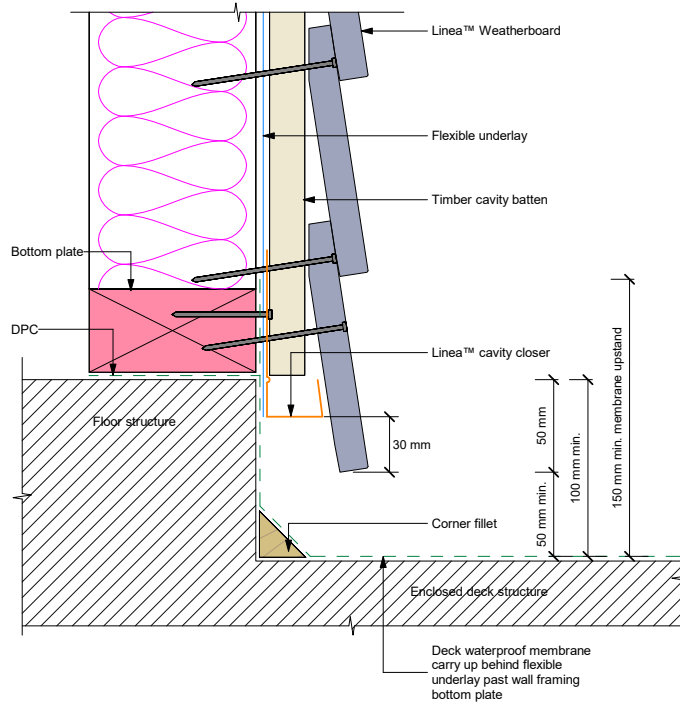
-The intermediate support for insulation between the studs could be a timber cavity batten, polypropylene tape or 75 mm galvanised wire mesh. Refer to E2/AS1 Paragraph 9.1.8.5 Polypropylene tape must be fixed horizontally and drawn taut at 300 mm centres.

**Figure 4: Foundation detail**

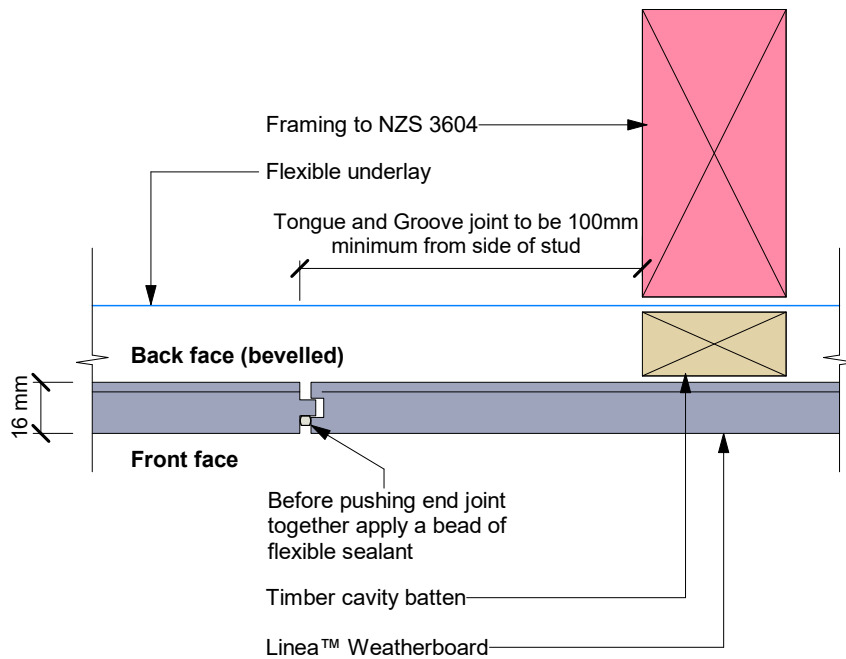


Note:  
 Drain holes in James Hardie uPVC vent strip are sufficient to achieve ventilation openings of 1000mm<sup>2</sup> per lineal metre

**Figure 5: Enclosed Deck**

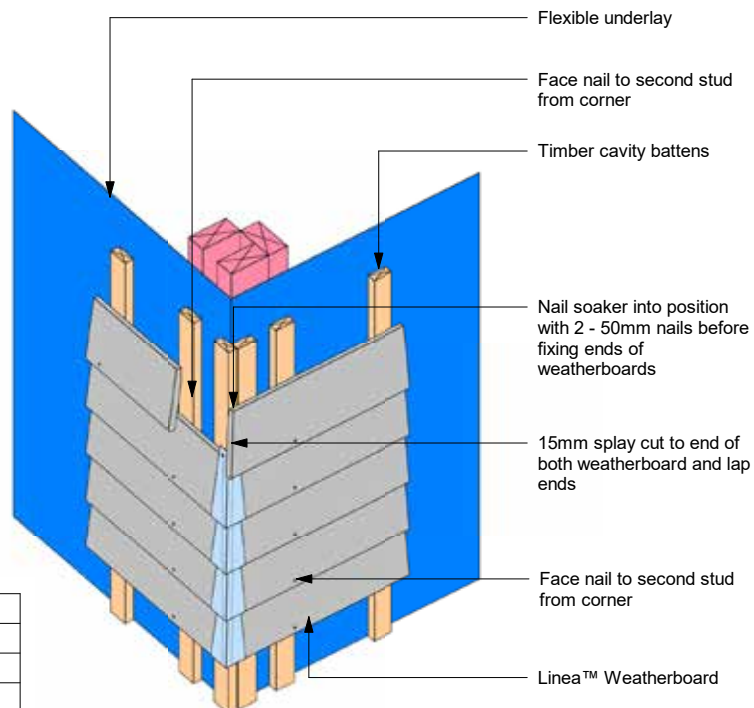


**Figure 6: Jointing off stud**



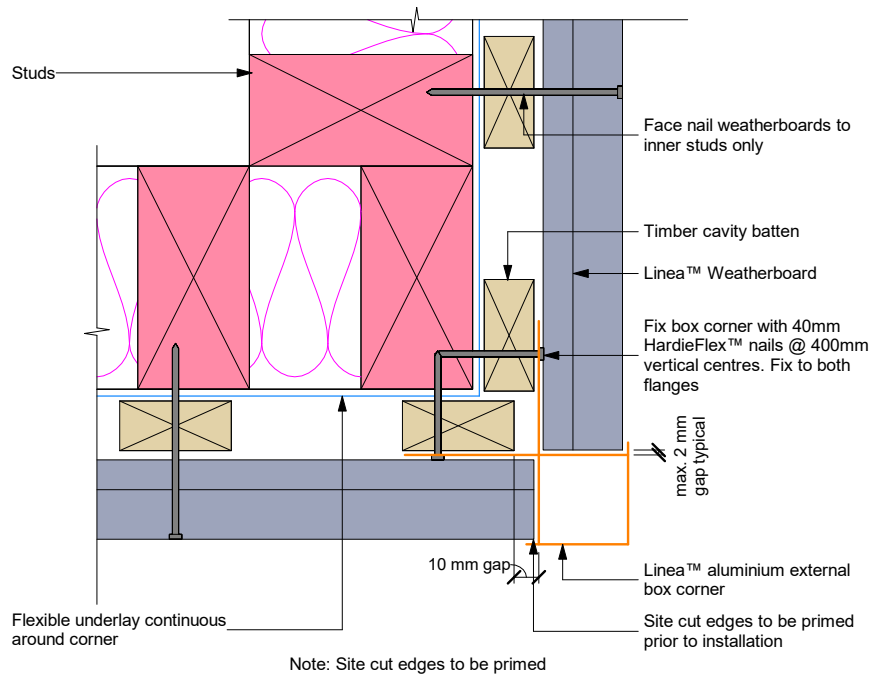
**Figure 7: External corner soaker**

interactive assembly instructions available  
<http://wksp.nz/jh-tin-excs>  
  
 Get WORKINGSPEC from Apple App Store/Google Play

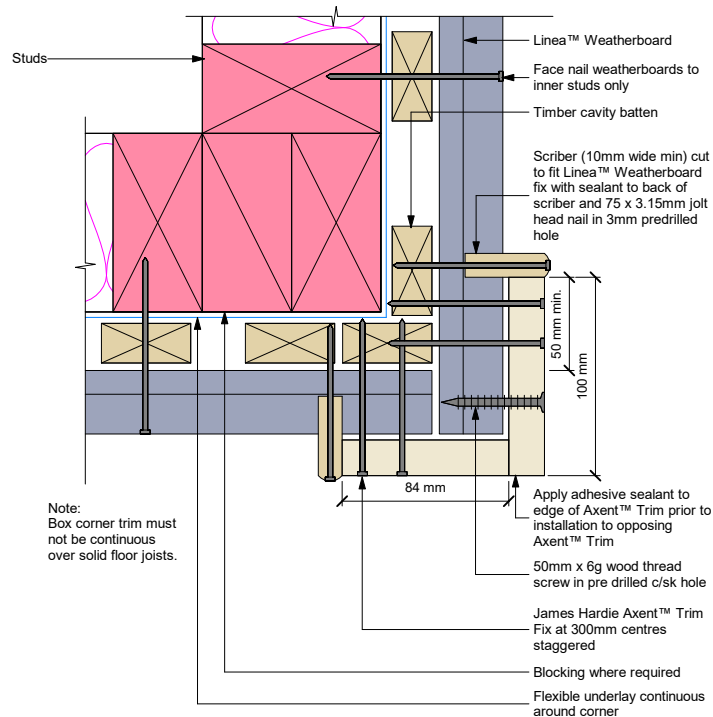


Soaker material	Nail material
Copper	Copper or phosphor bronze
Aluminium	Hot dip galvanised
Stainless steel	Stainless steel

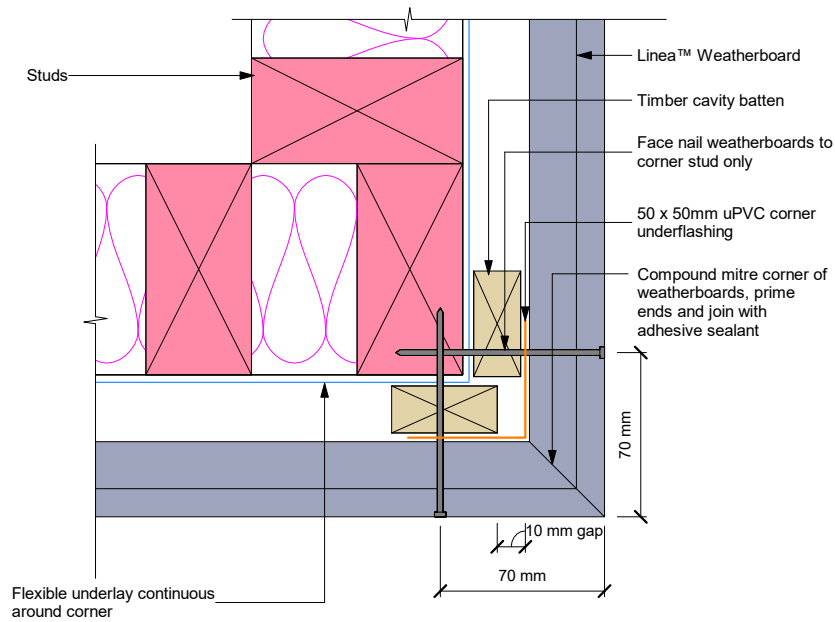
**Figure 8: Aluminium box corner**



**Figure 9: Boxed corner**



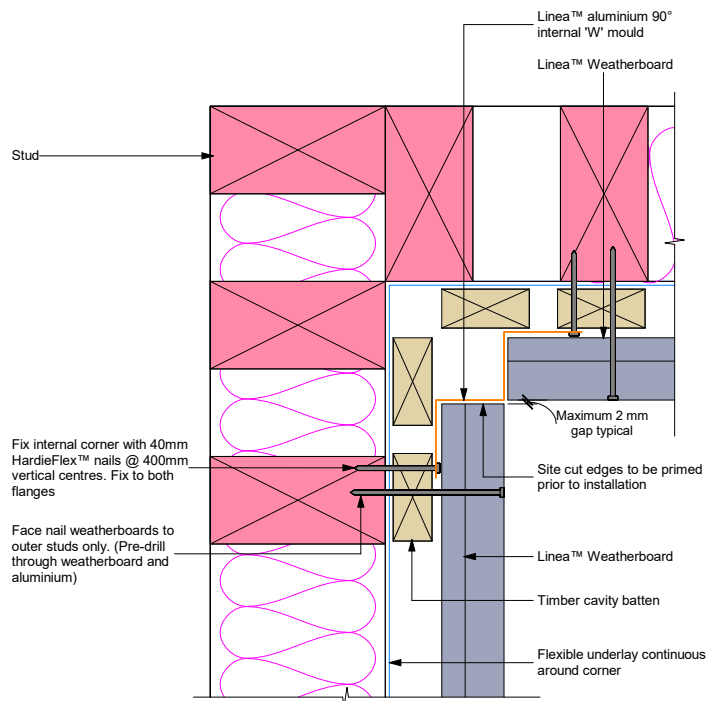
**Figure 10: Mitre corner**



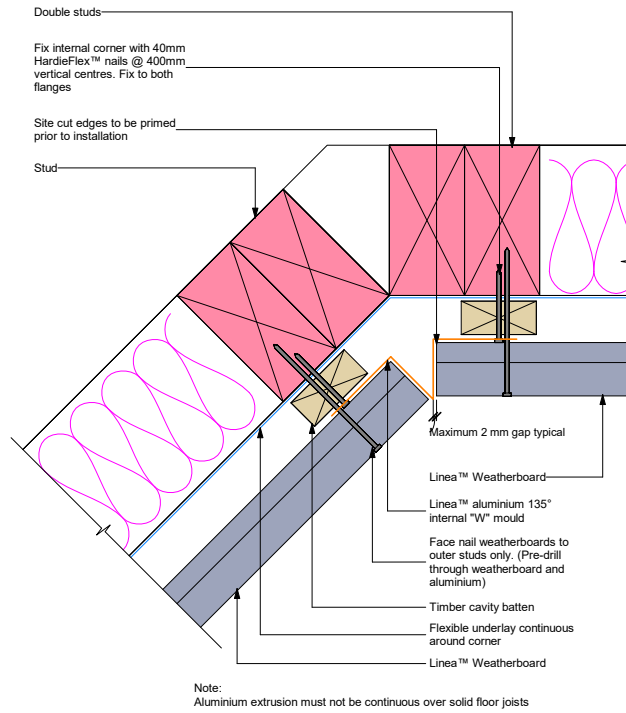
Note: Adhesive sealant must be used on the full end face of both weatherboards. Push lightly together

**Figure 11: Internal 90 ° aluminium 'W' mould corner**

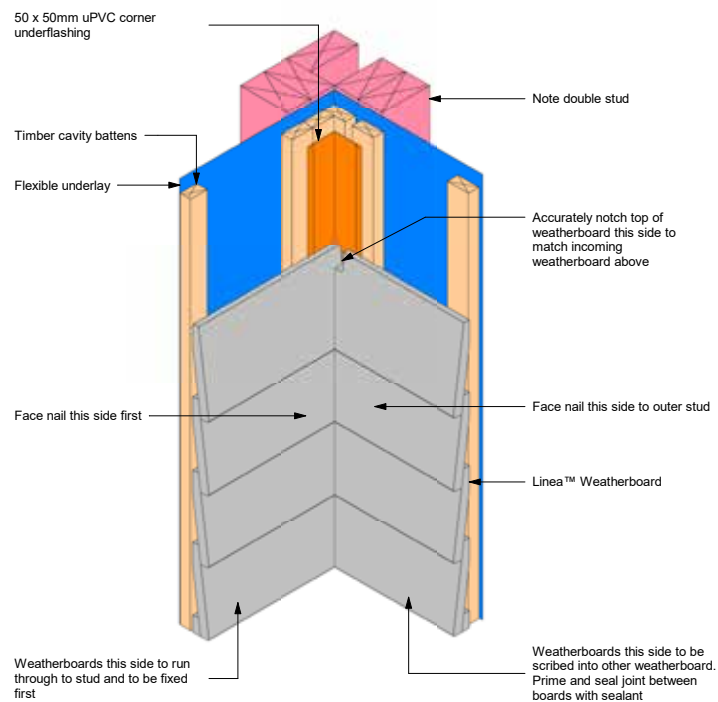
interactive assembly instructions available  
<http://wksp.nz/jh-lin-inc>  
  
 Get WORKINGSPEC from Apple App Store/Google Play



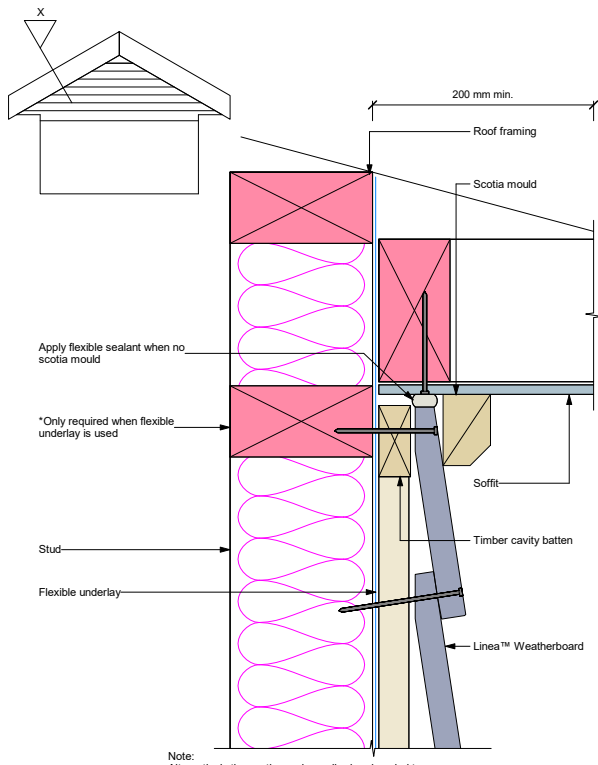
**Figure 12: Internal 135 ° aluminium 'W' mould corner**



**Figure 13: Internal corner joint flashing**

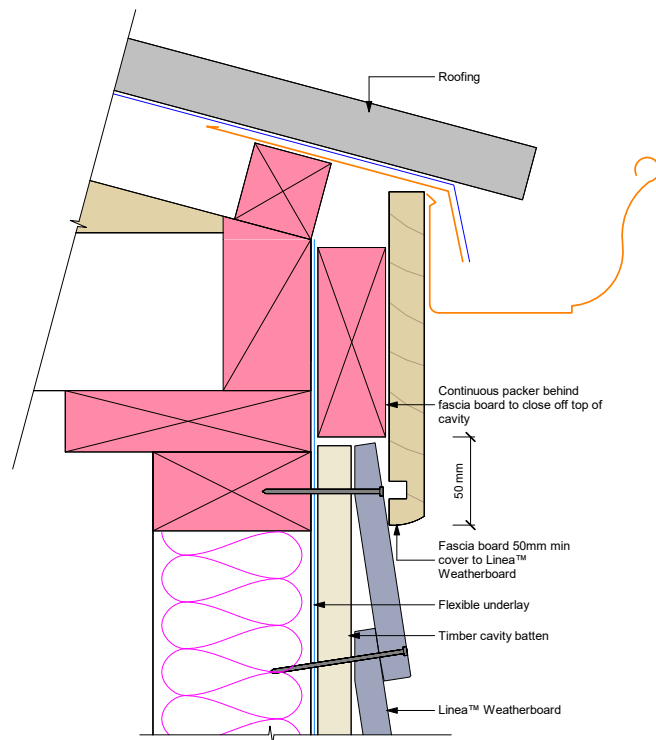


**Figure 14: Wall to soffit junction 'X'**



**Note:**  
 Alternatively the scotia can be scribed and sealed to Linea™ Weatherboard and the soffit lining  
 For soffits more than 200mm the Linea™ Weatherboard can be neat cut and silicone sealed to angle of soffit

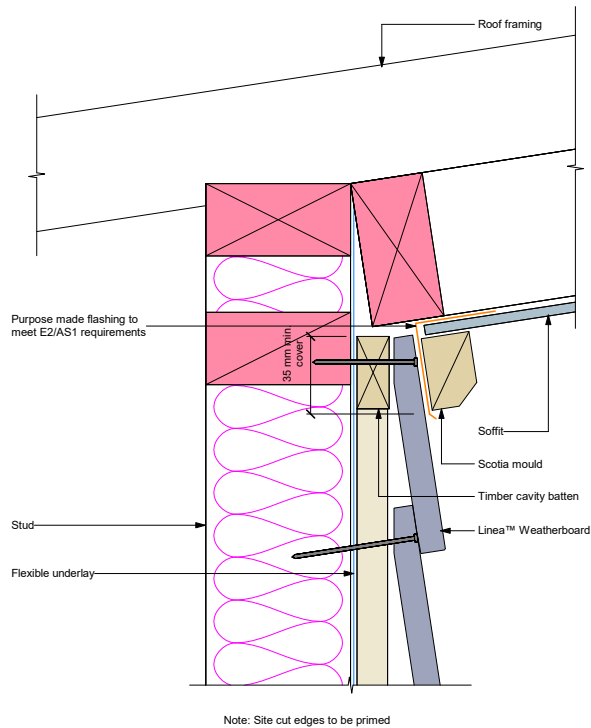
**Figure 15: Nil soffit detail**





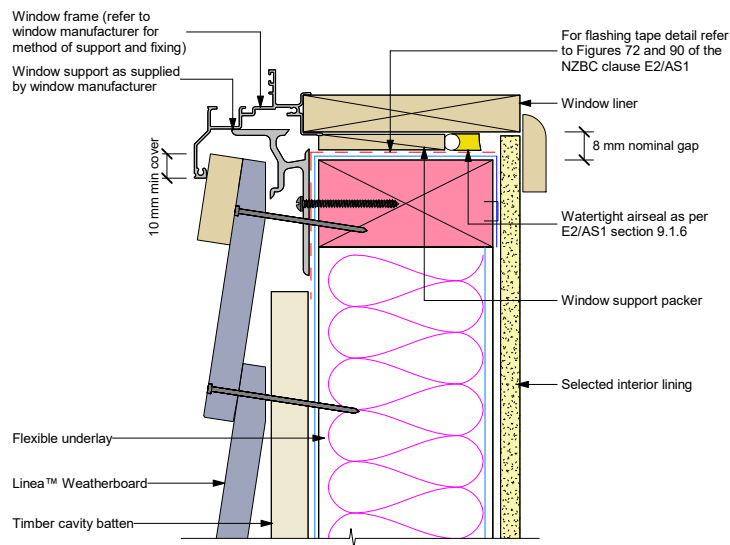
**Figure 16: Sloping soffit and wall junction**

interactive assembly instructions available  
<http://wksp.nz/jh-lin-sof>  
  
 Get WORKINGSPEC from Apple App Store/Google Play



**Figure 17: Window and door sill**

interactive assembly instructions available  
<http://wksp.nz/jh-lin-win>  
  
 Get WORKINGSPEC from Apple App Store/Google Play

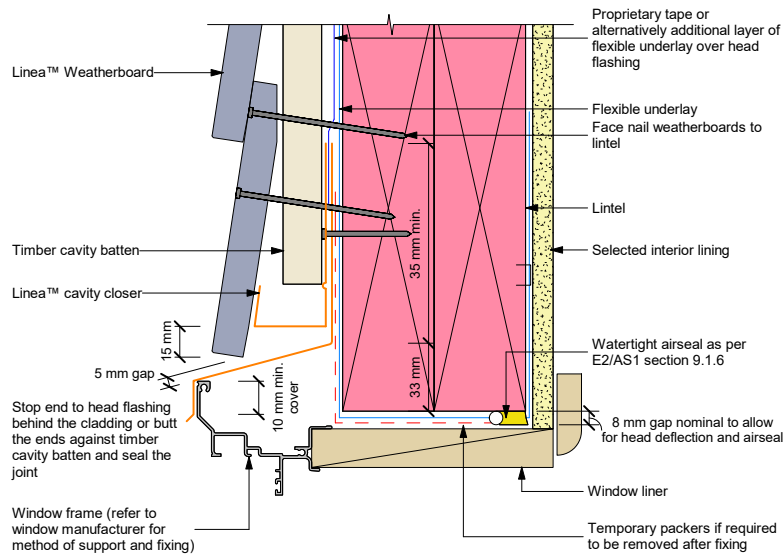


General notes for materials selection

1. Flashing materials must be selected based on environmental exposure, refer to NZS 3604 and Table 20 of NZBC E2/AS1
2. Flexible underlay must comply with acceptable solution E2/AS1
3. Flashing tape must have proven compatibility with the selected flexible underlay and other materials with which it comes into contact

Refer to the manufacturer or supplier for technical information for these materials

**Figure 18: Window head**



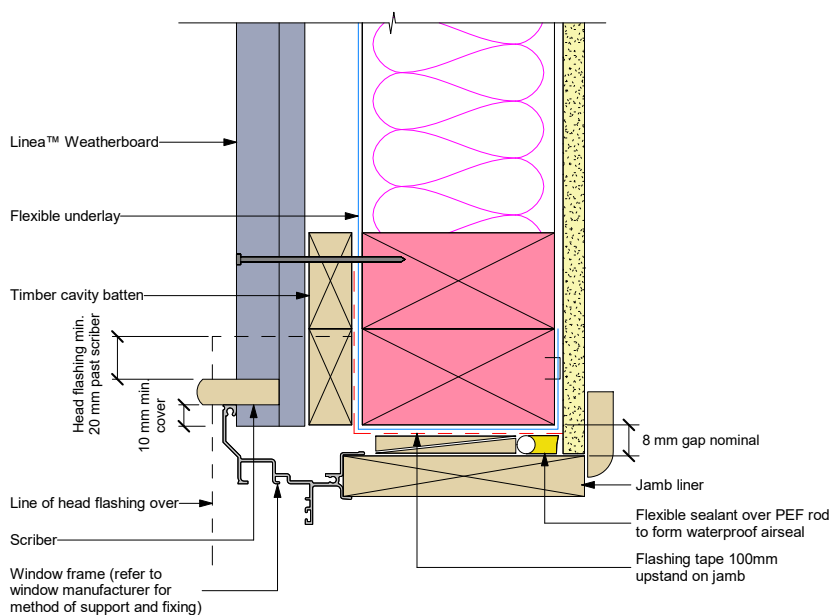
- Note:
- Sealant must be installed between head flashing and window flange in VH and EH wind zones and SED pressures
  - Alternatively, the head flashings can be formed with stop ends as per E2/AS1
  - Refer to Figure 22 for sealing end battens to head flashing
  - Site cut edges to be primed

interactive assembly instructions available  
<http://wksp.nz/jh-lin-win>



Get WORKINGSPEC from Apple App Store/Google Play

**Figure 19: Window jamb**

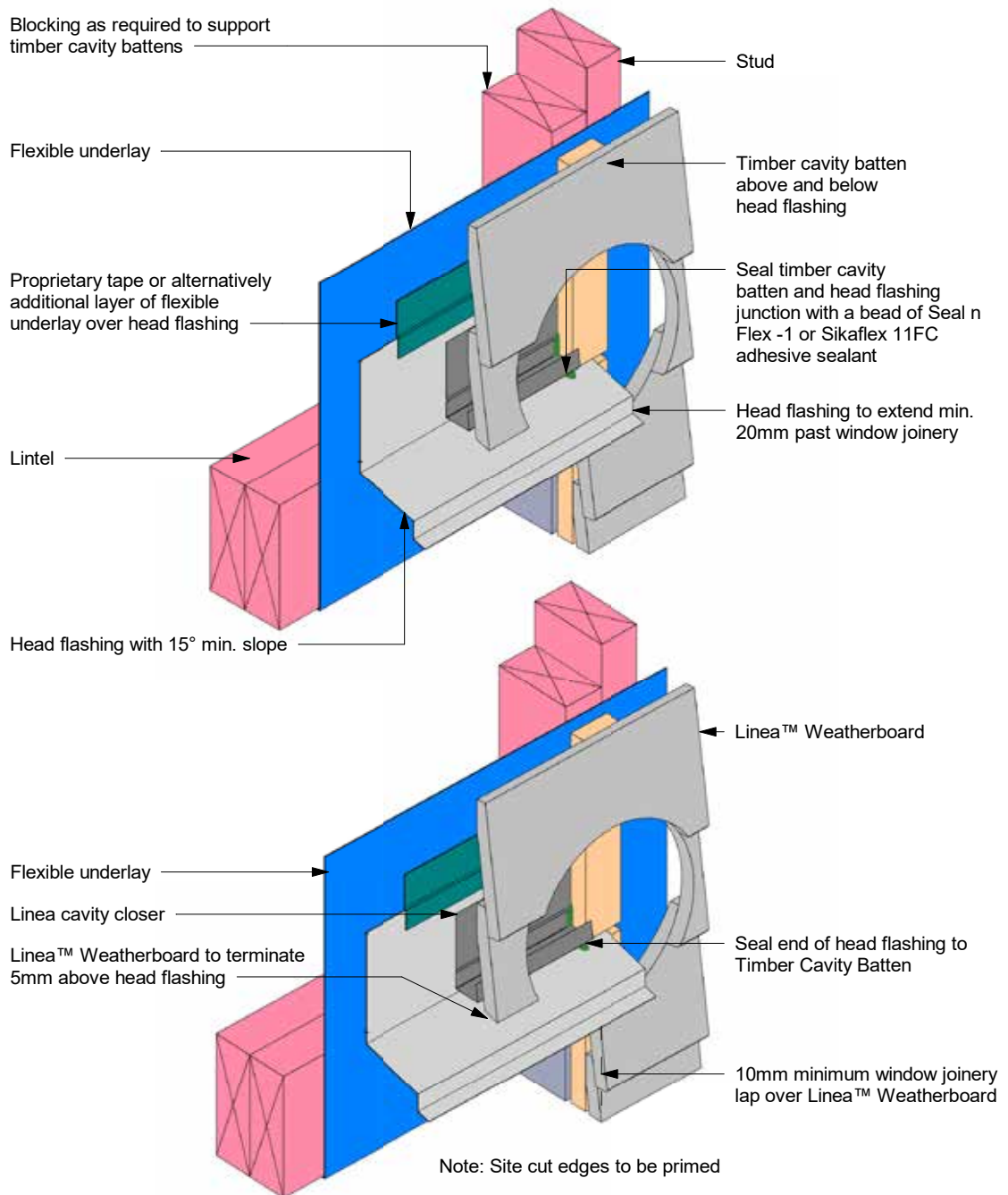


interactive assembly instructions available  
<http://wksp.nz/jh-lin-win>



Get WORKINGSPEC from Apple App Store/Google Play

**Figure 20: Window head stop end**



interactive assembly instructions available

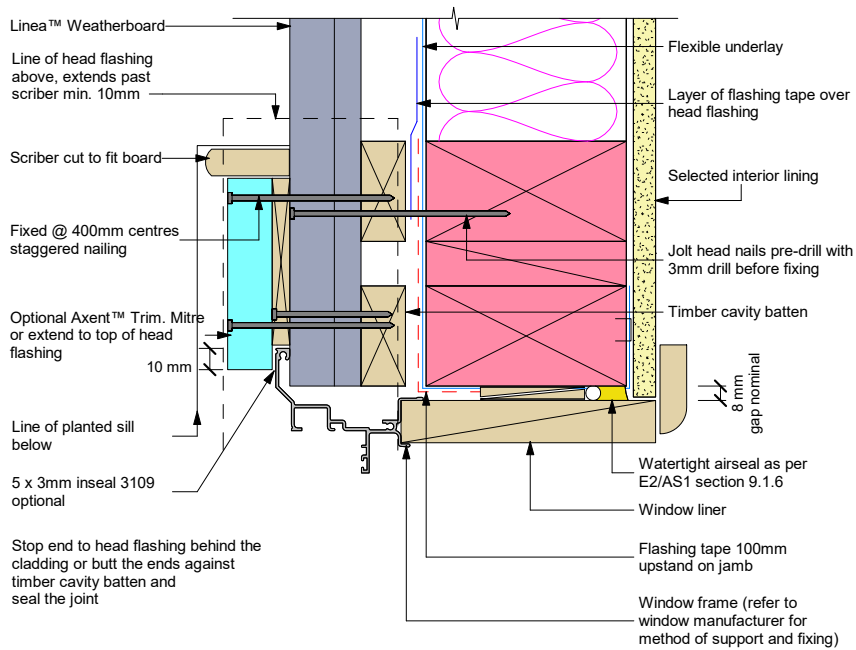
<http://wksp.nz/jh-lin-win>



Get WORKINGSPEC from Apple App Store/Google Play

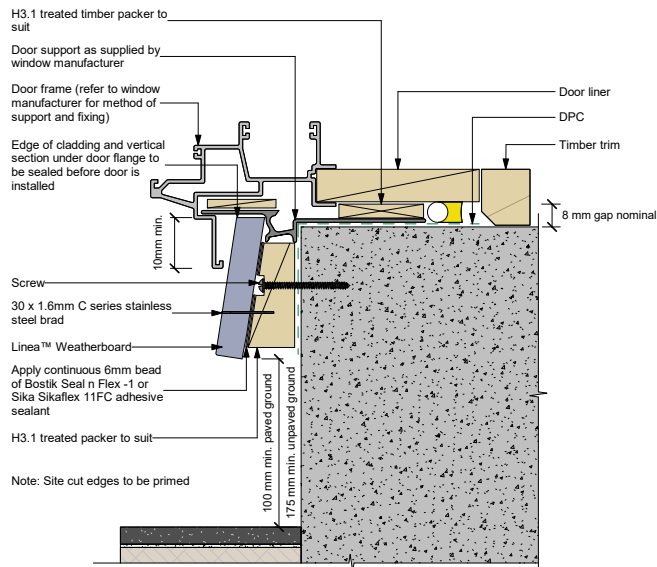


**Figure 23: Window jamb with facings**



Note:  
 • Site cut edges to be primed

**Figure 24: Door sill support detail**

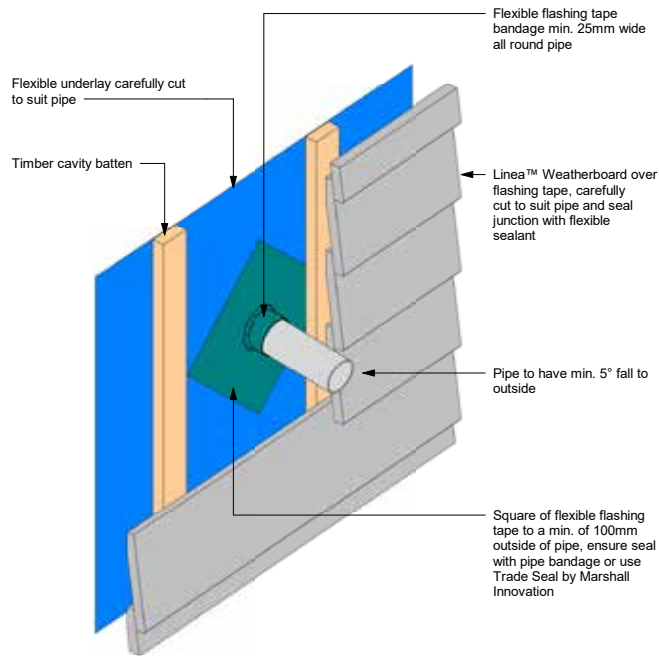


Refer to the manufacturer or supplier for technical information for these materials

General notes for materials selection

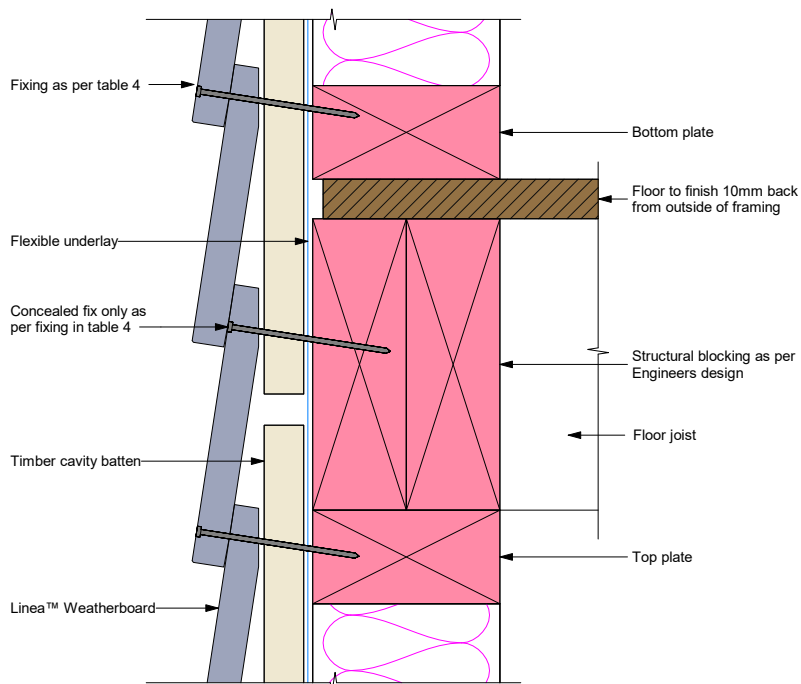
1. Flashing materials must be selected based on environmental exposure, refer to NZS 3604 and Table 20 of the NZBC E2/AS1
2. Flexible underlay must comply with acceptable solution E2/AS1
3. Flashing tape must have proven compatibility with the selected flexible underlay and other materials with which it comes into contact
4. Linea™ Weatherboard to have sealed butt joint over batten at each corner of opening

**Figure 25: Pipe penetration**



Note: Site cut edges to be primed

**Figure 26: Continous cladding over joist**

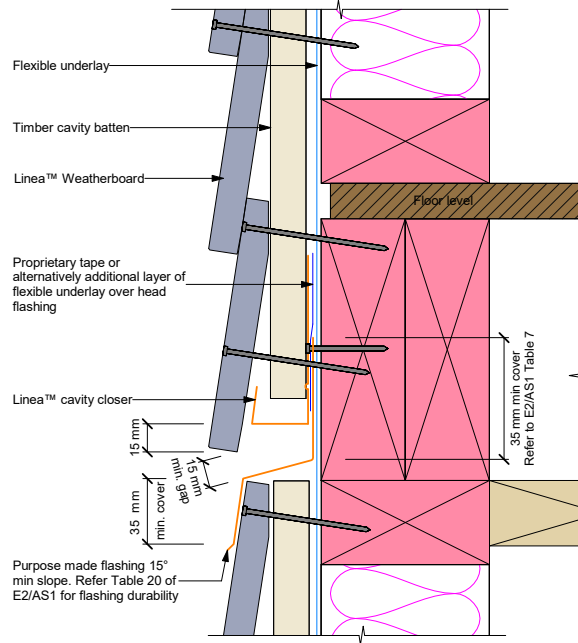


interactive assembly  
instructions available  
<http://wksp.nz/jh-lin-fj>



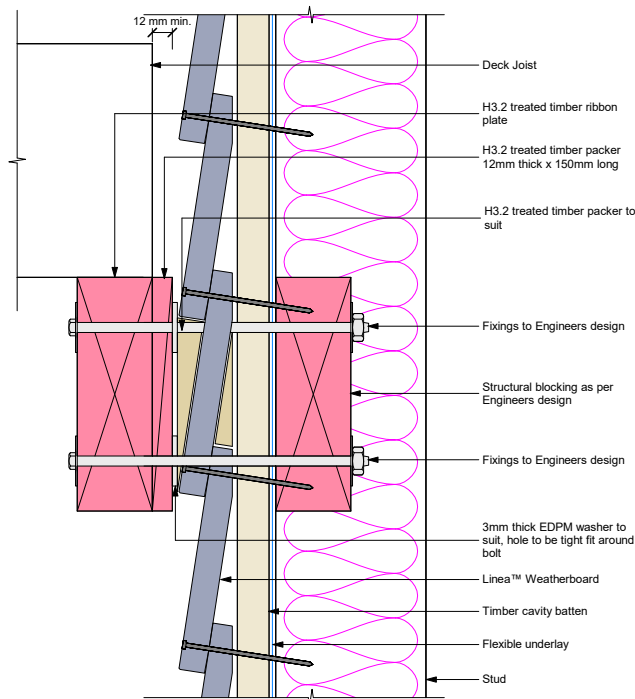
Get WORKINGSPEC from  
Apple App Store/Google Play

**Figure 27: Drained flashing joint at floor level**

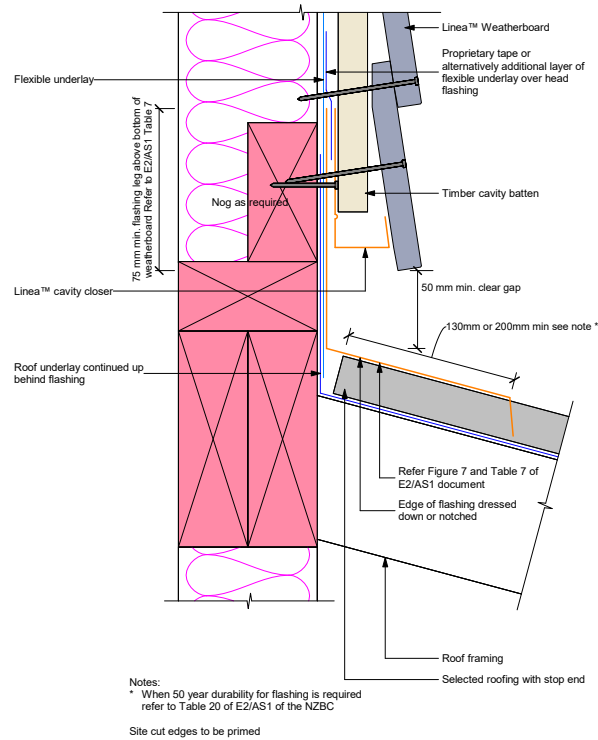


Note:  
This detail is required to limit cavities to a maximum of 2 stories  
or 7 metres. Refer E2/AS1 clause 9.1.9.4.

**Figure 28: Timber deck junction**

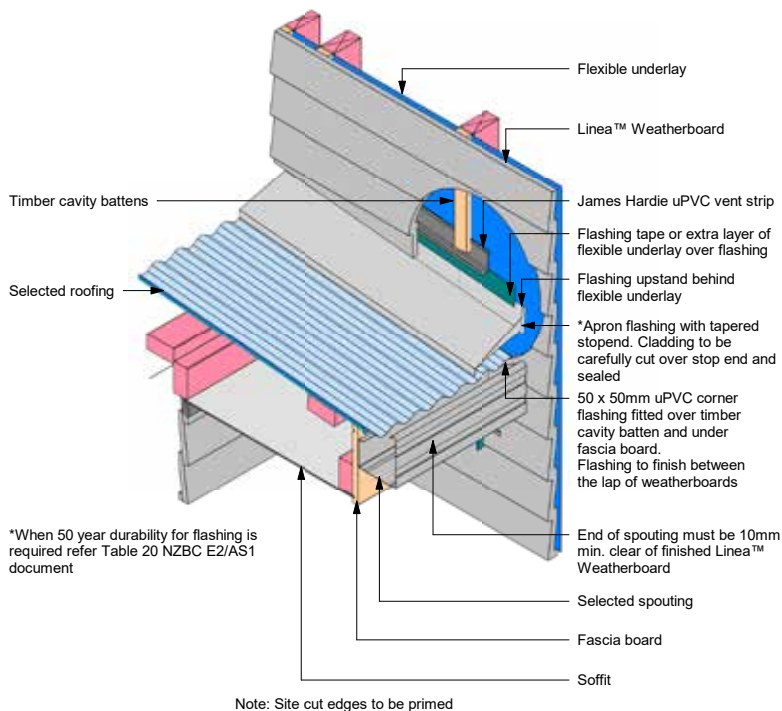


**Figure 29: One piece apron flashing joint**



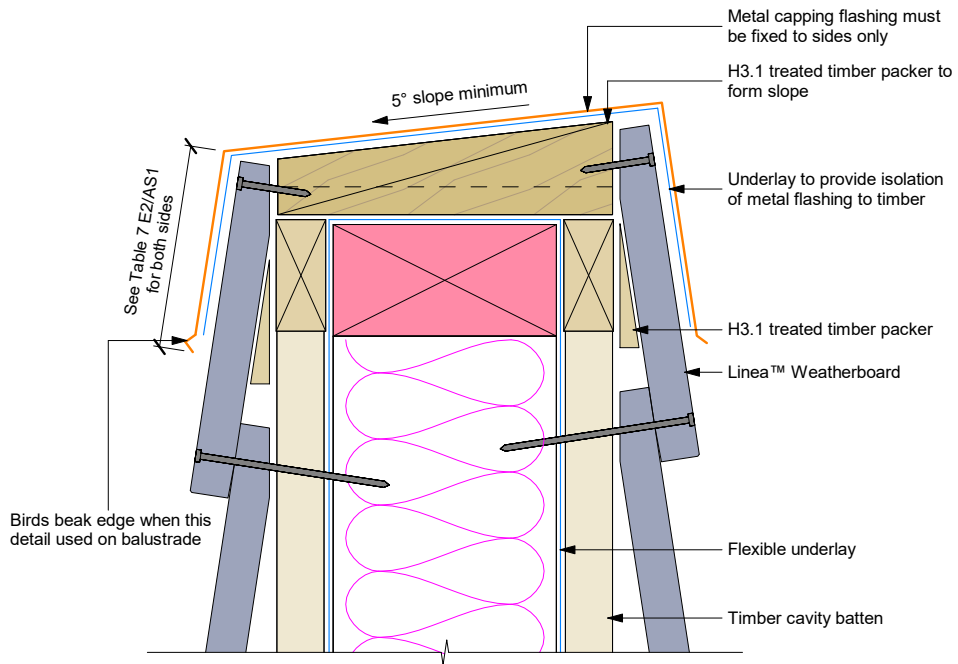
**Figure 30: Roof to wall junction detail**

interactive assembly instructions available  
<http://wksp.nz/jh-lin-rfw>  
  
 Get WORKINGSPEC from Apple App Store/Google Play

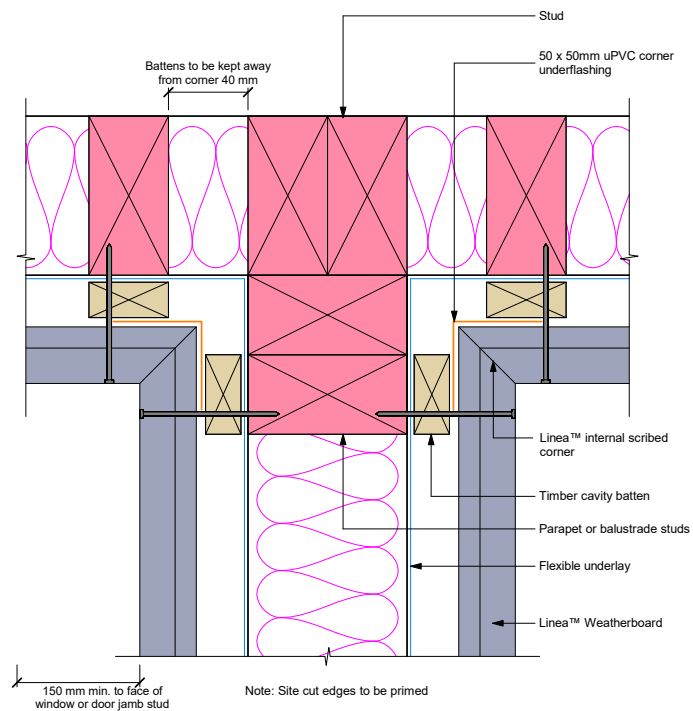




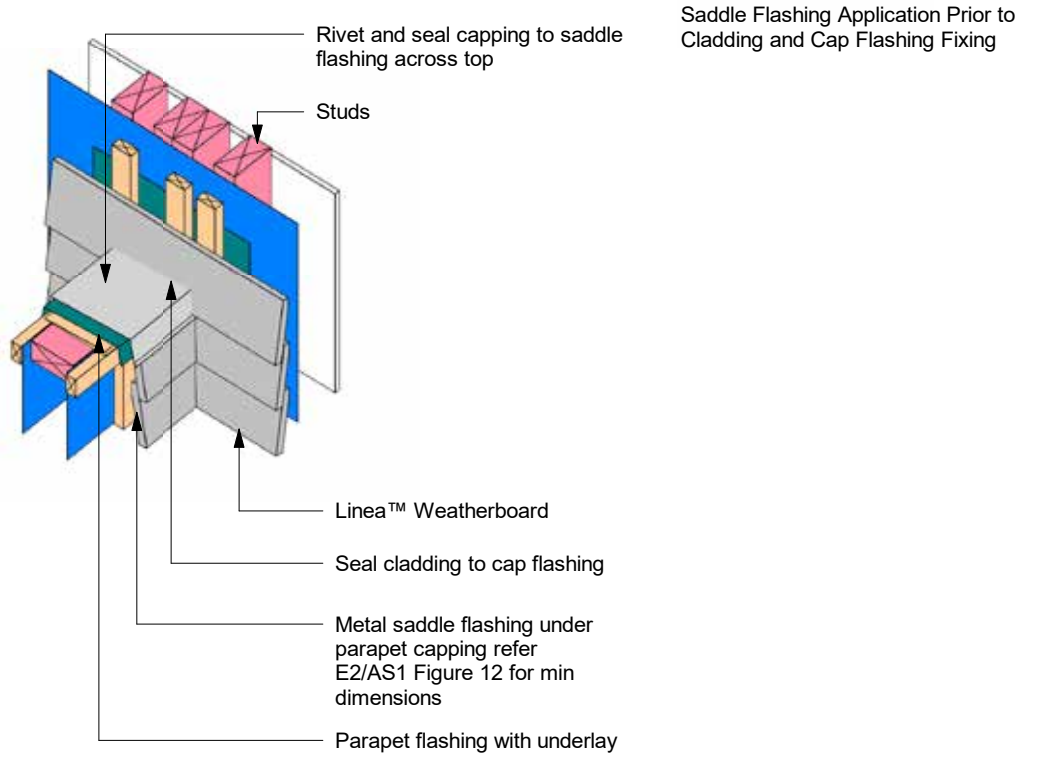
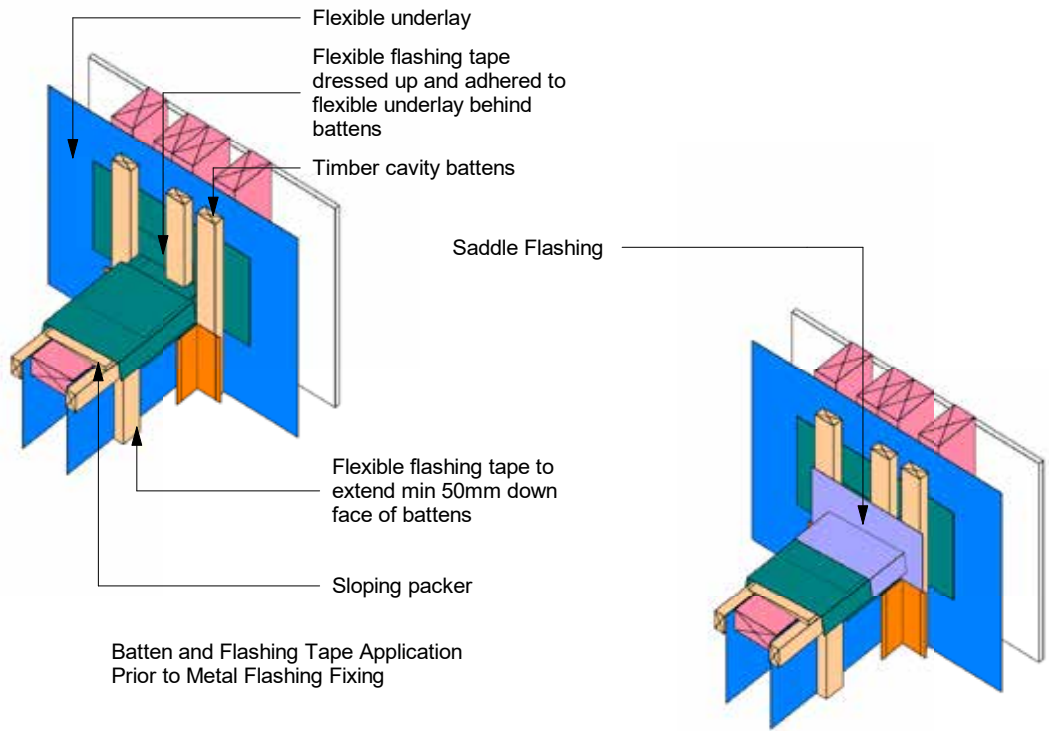
**Figure 31: Parapet flashing**



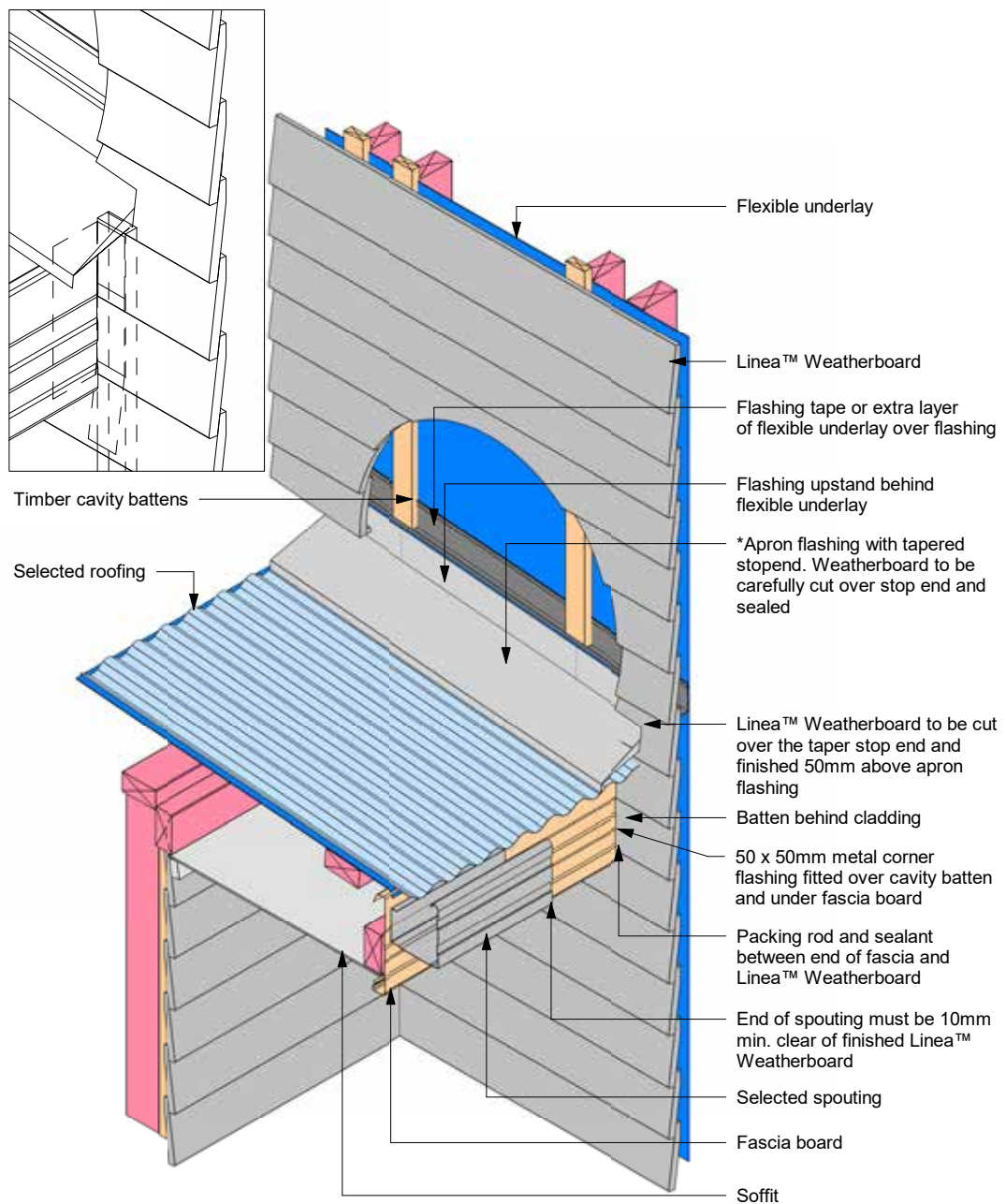
**Figure 32: Enclosed deck balustrade to wall**



**Figure 33: Enclosed balustrade to wall**



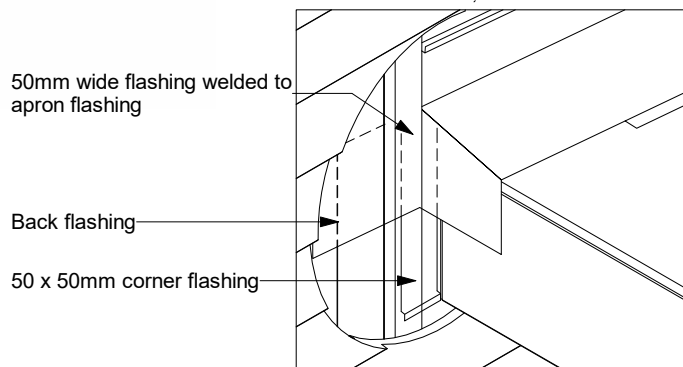
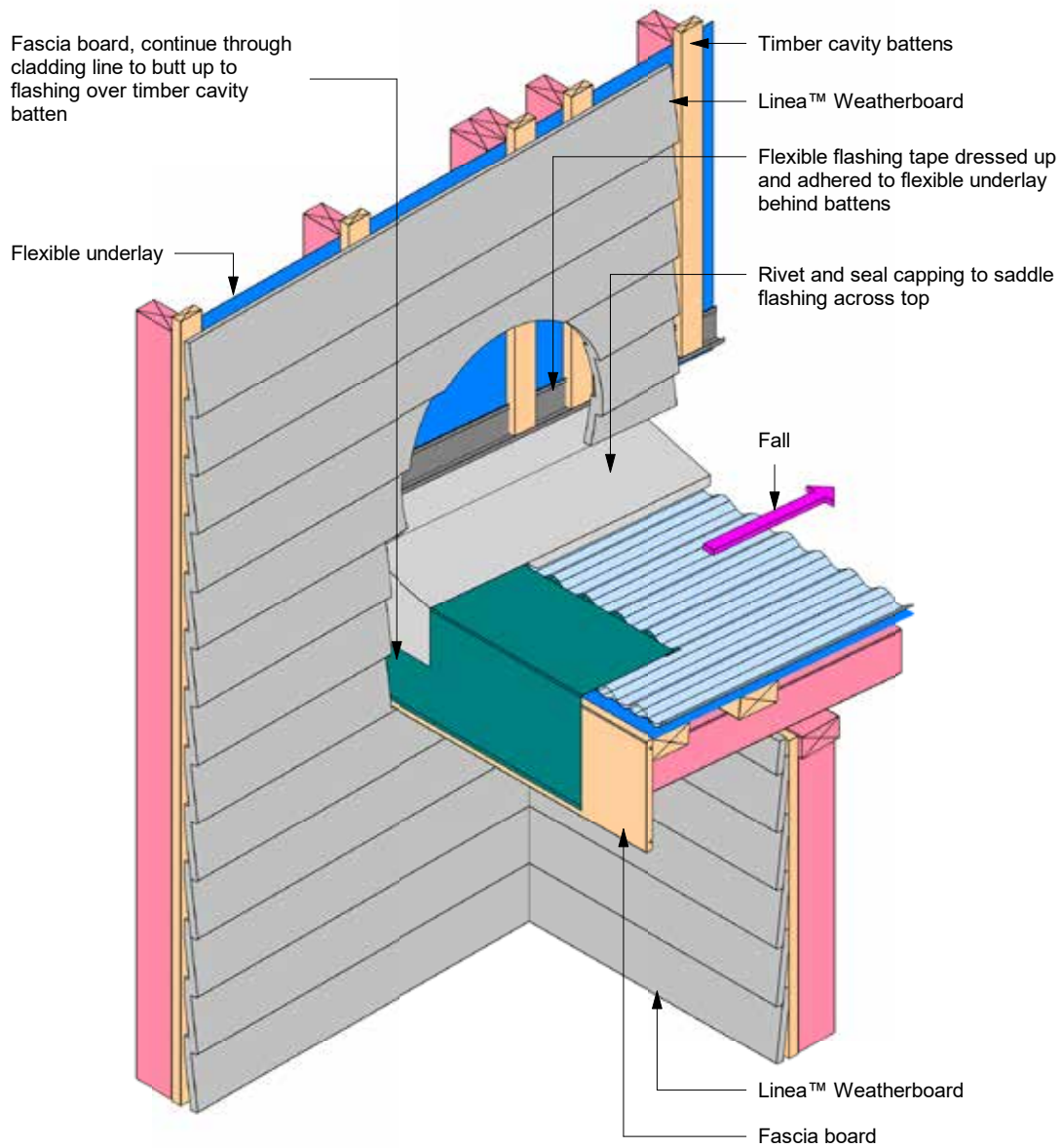
**Figure 34: Junction Linea™ Weatherboard and fascia board**



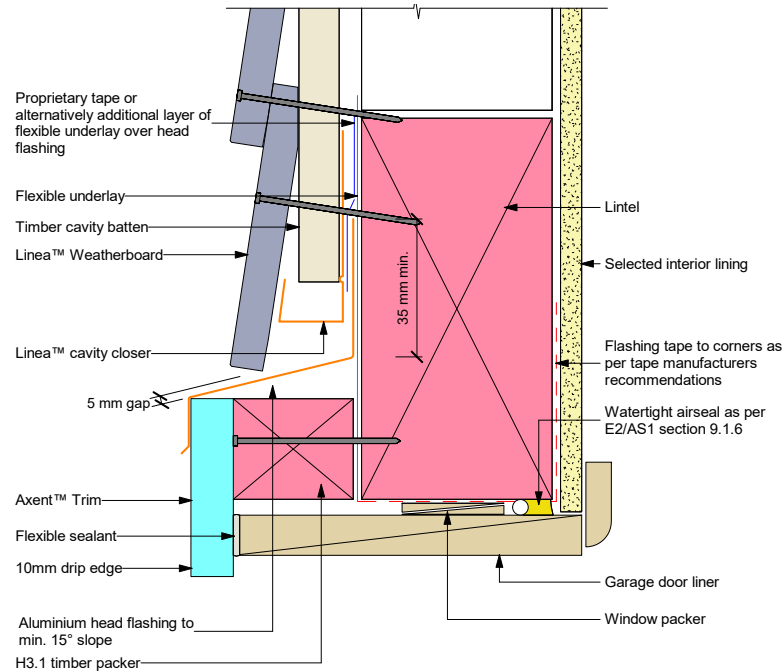
\*When 50 year durability for flashing is required refer Table 20 NZBC E2/AS1 document

Note: Site cut edges to be primed

**Figure 35: Enclosed roof to wall intersection**

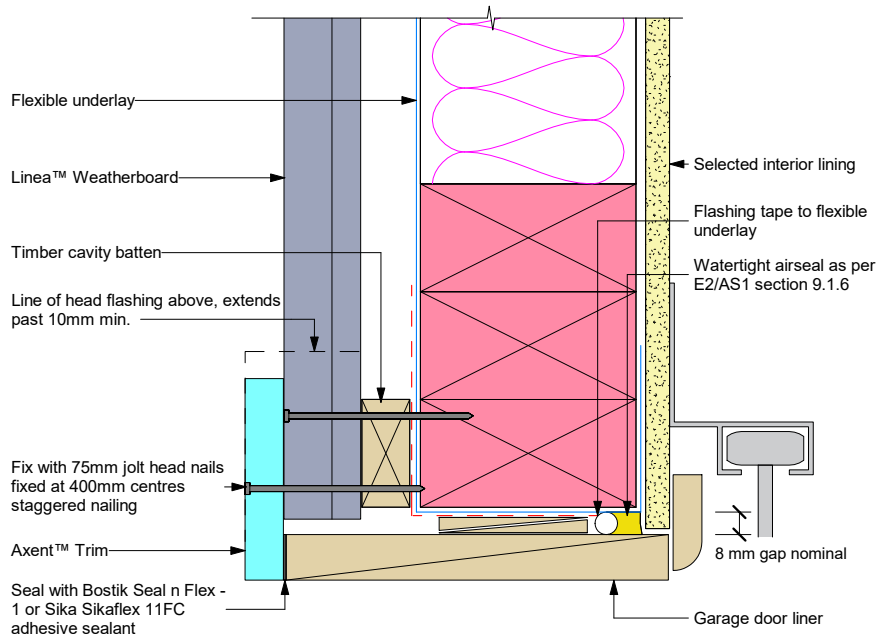


**Figure 36: Garage door head**



- Note:
- Sealant must be applied between head flashing and liner in VH and EH wind zones and SED wind pressures
  - Site cut edges to be primed

**Figure 37: Garage door jamb**



Note: Site cut edges to be primed

Figure 38: Framing setout building height over 10m

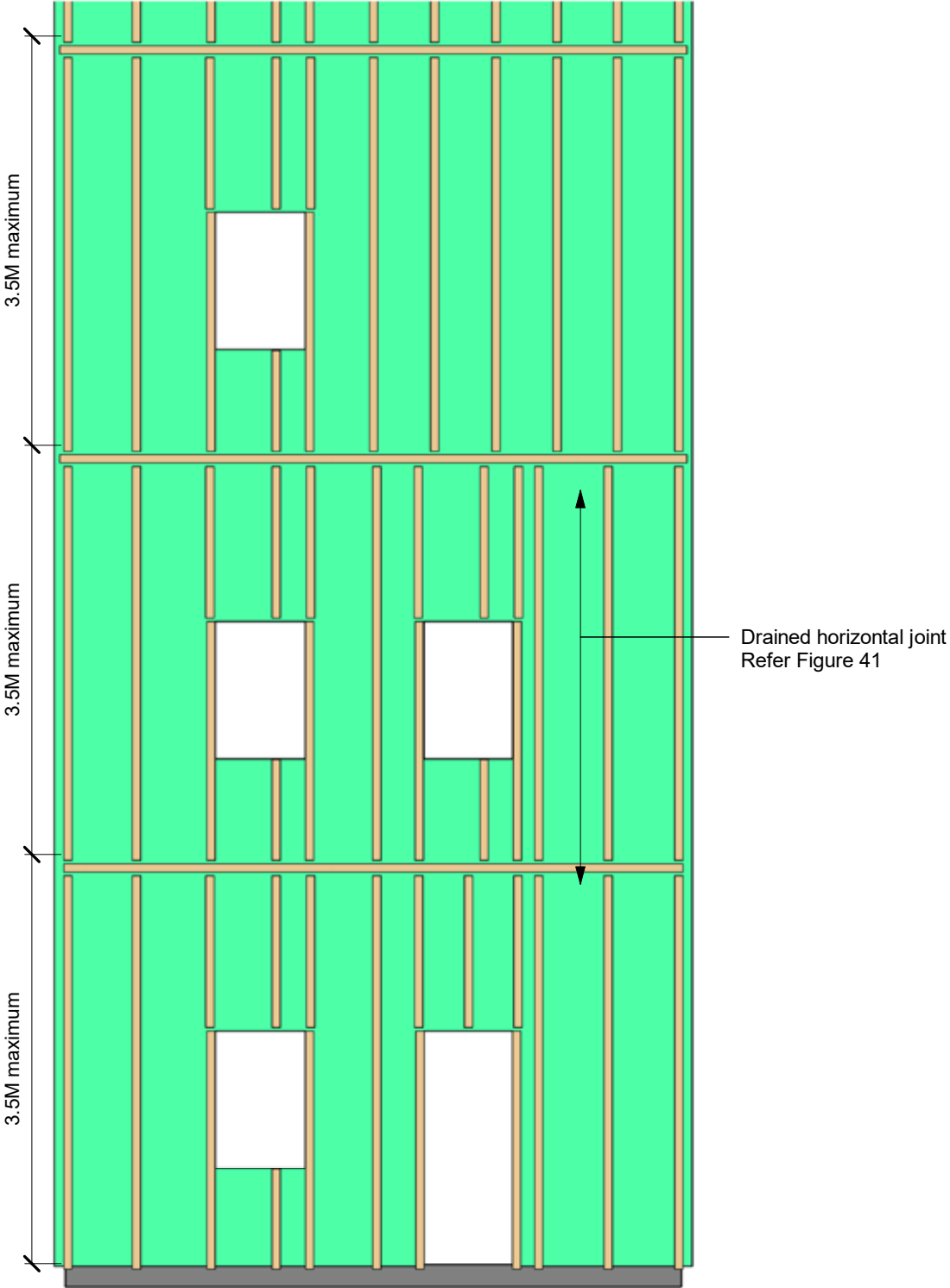
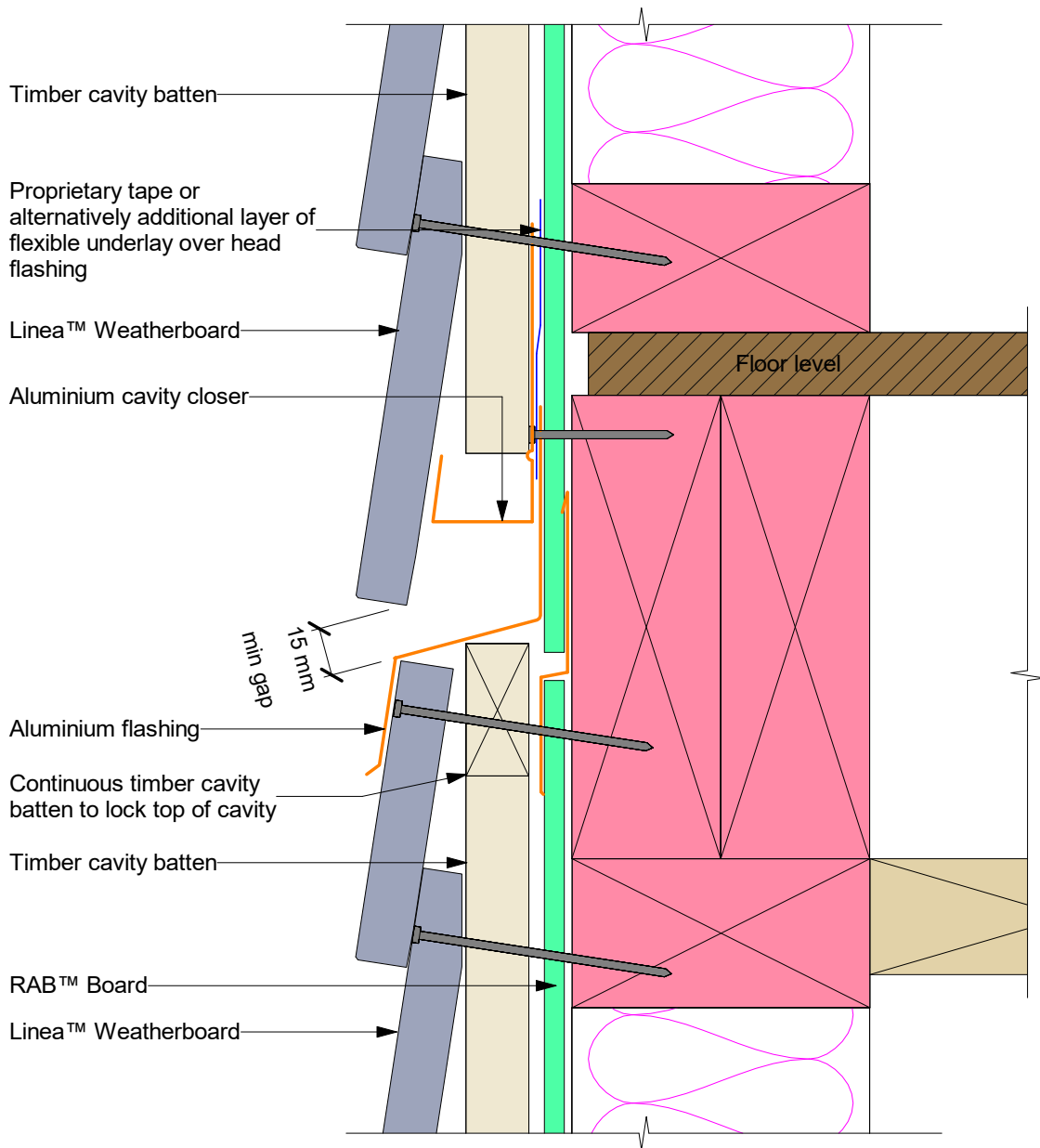


Figure 39: Intertency vertical fire separation











# Product Warranty

James Hardie New Zealand Limited (“James Hardie”) warrants for a period of 25 years from the date of purchase that the Linea™ Weatherboard (the “Product”), will be free from defects due to defective factory workmanship or materials and, subject to compliance with the conditions below, will be resistant to cracking, rotting, fire and damage from termite attacks to the extent set out in James Hardie’s relevant published literature current at the time of installation. James Hardie warrants for a period of 15 years from the date of purchase that the Axent™ Trim and accessories supplied by James Hardie will be free from defects due to defective factory workmanship or materials.

Nothing in this document shall exclude or modify any legal rights a customer may have under the Consumer Guarantees Act or otherwise which cannot be excluded or modified at law.

## CONDITIONS OF WARRANTY:

The warranty is strictly subject to the following conditions:

- a) James Hardie will not be liable for breach of warranty unless the claimant provides proof of purchase and makes a written claim either within 30 days after the defect would have become reasonably apparent or, if the defect was reasonably apparent prior to installation, then the claim must be made prior to installation.
- b) This warranty is not transferable.
- c) The Product must be installed and maintained strictly in accordance with the relevant James Hardie literature current at the time of installation and must be installed in conjunction with the components or products specified in the literature. Further, all other products, including coating and jointing systems, applied to or used in conjunction with the Product must be applied or installed and maintained strictly in accordance with the relevant manufacturer’s instructions and good trade practice.
- d) The project must be designed and constructed in strict compliance with all relevant provisions of the current New Zealand Building Code (“The NZBC”), regulations and standards.
- e) The claimant’s sole remedy for breach of warranty is (at James Hardie’s option) that James Hardie will either supply replacement product, rectify the affected product or pay for the cost of the replacement or rectification of the affected product.
- f) James Hardie will not be liable for any losses or damages (whether direct or indirect) including property damage or personal injury, consequential loss, economic loss or loss of profits, arising in contract or negligence or howsoever arising. Without limiting the foregoing James Hardie will not be liable for any claims, damages or defects arising from or in any way attributable to poor workmanship, poor design or detailing, settlement or structural movement and/or movement of materials to which the Product is attached, incorrect design of the structure, acts of God including but not limited to earthquakes, cyclones, floods or other severe weather conditions or unusual climatic conditions, efflorescence or performance of paint/coatings applied to the Product, normal wear and tear, growth of mould, mildew, fungi, bacteria, or any organism on any Product surface or Product (whether on the exposed or unexposed surfaces).
- g) All warranties, conditions, liabilities and obligations other than those specified in this warranty are excluded to the fullest extent allowed by law.
- h) If meeting a claim under this warranty involves re-coating of Products, there may be slight colour differences between the original and replacement Products due to the effects of weathering and variations in materials over time.

**Disclaimer:** The recommendations in James Hardie’s literature are based on good building practice, but are not an exhaustive statement of all relevant information and are subject to conditions (c), (d), (f) and (g) above. James Hardie has tested the performance of Linea™ Weatherboard when installed in accordance with the appropriate Linea Weatherboard (cavity or direct fixed) technical specifications, in accordance with the standards and verification methods required by the NZBC and those test results demonstrate the product complies with the performance criteria established by the NZBC. However, as the successful performance of the relevant system depends on numerous factors outside the control of James Hardie (e.g. quality of workmanship and design) James Hardie shall not be liable for the recommendations made in its literature and the performance of the relevant system, including its suitability for any purpose or ability to satisfy the relevant provisions of the NZBC, regulations and standards, as it is the responsibility of the building designer to ensure that the details and recommendations provided in the relevant James Hardie installation manual are suitable for the intended project and that specific design is conducted where appropriate.

Copyright 2020. © James Hardie New Zealand Limited. TM and ® denotes a Trademark or Registered Mark owned by James Hardie Technology Limited.

Linea™  
WEATHERBOARD

