



# D Series

Locks & latches



Fire Rated: Tested on fire door assemblies in accordance with Australian Standards, refer fire door manufacturer for specific approval details

D Series locks are recommended when the highest standards of quality and performance are required. Designed for durability and function, precision manufactured to exact tolerances, the D Series is best suited for commercial, institutional and industrial use. The specialised functions satisfy virtually any cylindrical lock application.

## Features

- Cylindrical housing: heavy gauge cold rolled steel mechanisms are corrosion treated for normal atmosphere conditions
- Roller bearings and coil compression springs on anti-friction latch retractors ensure long life and smooth action
- Threaded roses hold lock firmly in place
- Friction grip nylon ring, holds rose securely in place
- Concealed mounting screws
- Exceeds 800,000 cycle ANSI/BHMA Grade 1 requirements
- Exceeds ANSI/BHMA A156.2 Series 4000 Grade 1 lock knob torque requirements
- The 10 year warranty provides specifiers and users with assured quality and performance

# Specification guide

Function	Knob	Finish
Passage latch ..... D10S	Orbit ..... ORB	Satin chrome plate..... SCP
Privacy latch ..... D40S	Plymouth..... PLY	
Entrance lock ..... D53PD		
Store lock ..... D66PD		
Classroom lock ..... D70PD		
Storeroom lock ..... D80PD		
Single dummy trim ..... D170		

- Function  
Select the desired function e.g. Entrance lock ..... D53PD
- Knob  
Select the desired knob e.g. Plymouth ..... D53PDPLY
- Finish  
Select the desired finish e.g. Satin chrome plate ..... D53PDPLYSCP

## Orbit

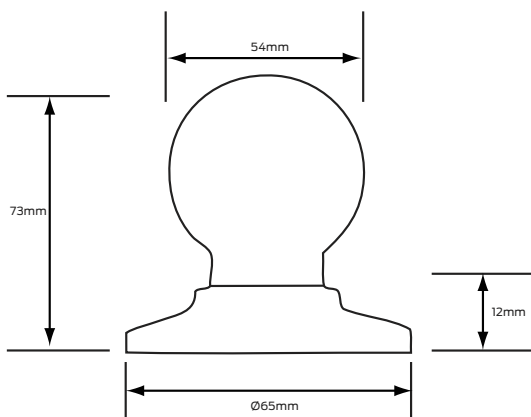

### Specifications

<b>Door type</b>	Timber or metal
<b>Door thickness</b>	35mm to 51mm
<b>Chassis</b>	Cold rolled steel, corrosion treated
<b>Knob</b>	Wrought brass
<b>Forend</b>	Stainless steel
<b>Bolt</b>	Brass
<b>Strike plate</b>	Steel
<b>Backsets</b>	70mm standard. 60mm, 95mm and 127mm backset latches available
<b>Key cylinder</b>	Schlage C6 pin keyway standard, Schlage E6 pin keyway optional, Schlage Everest D keyway optional
<b>Finish</b>	Satin chrome plate
<b>Warranty</b>	10 year mechanical

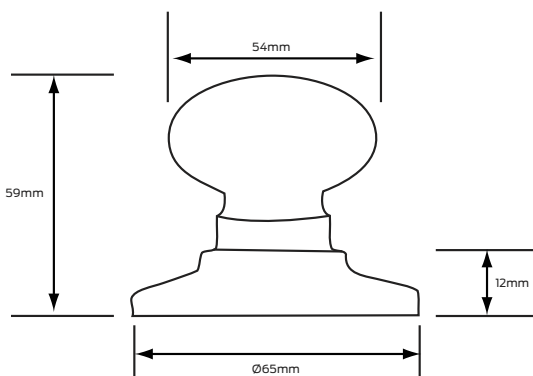

## Plymouth



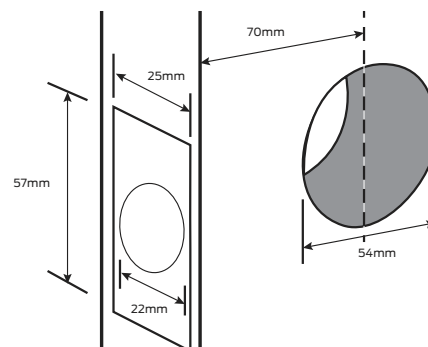



### Door preparation



## Schlage D Series non-keyed

Function	Outside	Inside
<b>D10S - Passage latch</b> Both knobs always unlocked		
<b>D40S - Bath/bedroom privacy lock</b> Push-button locking locks outside knobs. Turning inside knob or closing door releases button. Outside knob has emergency release		
<b>D170 - Single dummy trim</b> Dummy trim for one side of door. Used for door pull or as matching inactive trim		

## Schlage D Series keyed

Function	Outside	Inside
<b>D53PD - Entrance lock</b> Turn/push-button locking; pushing and turning button locks outside knob requiring use of key until button is manually unlocked. Push-button locking; pushing button locks outside knob until unlocked by key or by turning inside knob		
<b>D66PD - Store door lock</b> Key in either knob locks or unlocks both knobs		
<b>D70PD - Classroom lock</b> Outside knob locked and unlocked by key. Inside knob always unlocked		
<b>D80PD - Storeroom lock</b> Outside knob fixed. Entrance by key only. Inside knob always unlocked		

# Schlage D Series accessories

## Springlatch

**Backset:** 60mm, 70mm, 95mm and 127mm  
**Finish:** Satin chrome plate

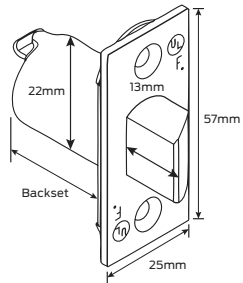

## Deadlatch

**Backset:** 60mm, 70mm, 95mm and 127mm  
**Finish:** Satin chrome plate

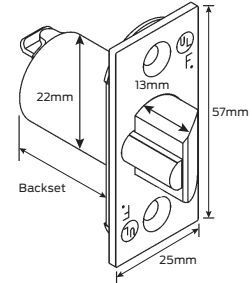

## Strikes

Optional lip lengths available  
**Finish:** Satin chrome plate

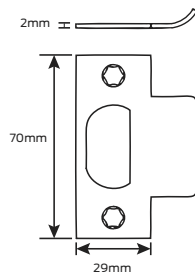

## Rebate kit

This kit adapts latches and strikes for 13mm rebated door and frame preparations

