

# Cable Management

Design and Technical Information  
2018





## MARLEY NEW ZEALAND

Marley New Zealand manufactures extruded and injection moulded uPVC and Polyethylene products for the New Zealand building, civil infrastructure and rural markets. Marley also export products to the Pacific Islands, South East Asia, Australia and the UK.

Today there are over 200 people in the Marley NZ team with manufacturing taking place on two sites – Auckland in the North Island, which also houses the Head Office, and Christchurch in the South Island.

### Aliaxis Group



Marley New Zealand is part of the Aliaxis group, a privately owned business based in Belgium which employs 15,700 people across forty countries and is made up of 100 companies worldwide. Each of these companies manufactures and/or markets plastic products for construction, industrial and public uses. Marley NZ is the largest division of Aliaxis in New Zealand and the largest manufacturer of uPVC pipes and fittings in New Zealand.

### Keep New Zealand Green



Marley is committed to conducting its business in a manner that is compatible with the environment with regards to where our products are sourced, manufactured, used and disposed. Marley operates a uPVC recycling program as part of our ISO 14001 environmental management system and is Best Environmental Practice certified for its entire manufactured range of uPVC systems. This allows designers and installers to achieve GreenStar credits when using Marley uPVC systems in commercial buildings.

## MAKE IT MARLEY

- Reliable local manufacturer for over 50 years
- Commitment to a sustainable future
- Experienced technical and production teams to ensure quality and rigorous testing
- ISO 9001 and 14001 accreditation
- Complete range of products and systems
- Nationwide distribution network
- 100% Recyclable products
- Best Environmental Practice (BEP) accreditation of uPVC systems.
- Access to international resources through parent company



## MARLEY MEANS QUALITY

Marley NZ Ltd is ISO 9001 accredited and holds a Bureau Veritas License for the manufacture of uPVC Conduit and Fittings AS/NZS 61386.21 Lic No 2755.





## CABLE MANAGEMENT

Marley New Zealand Ltd manufacture and supply a wide range of plastic systems for the conveyance and protection of various cable systems. This includes power cables, communication cables and fibre optics.

The systems are manufactured from either uPVC, polyethylene or polypropylene and each come with a range of fittings to facilitate their use in Buildings or Civil projects.

### Building

Marley conduit systems are used for power cables and are generally used in exposed situations i.e. external to the wall, although they can also be used within wall or floor cavities and are suitable for casting in concrete. The tested temperature range of  $-15^{\circ}\text{C}$  to  $+60^{\circ}\text{C}$  enables uPVC conduit to be used in cold areas as well as in roof spaces which may be subjected to elevated temperatures.

Marley ARMA Above Ground Conduit complies with the conduit requirements of AS/NZS 5033, and therefore can be used for solar panel installations.

Flexible conduits are also available for above ground applications where increased flexibility is required due to a high number of changes in direction.

Trunking systems are available in a range of sizes for use with single cables or a number of cables. They are suitable for alarm wiring, data installations or telephone wiring and provide access to the wiring after installation if required.

Air-con duct systems are used for carrying and protecting cables for heat pump and air conditioner installations.

### Civil

Ducting systems are used in buried applications for conveying and protecting various cabling systems. They are available in straight lengths up to 6 metres for the rigid ducts and lengths up to 1000 metres for continuous ducts.

The rigid ducts are manufactured from uPVC and the continuous ducts are polyethylene.

An electrical access pit is also available to provide easy access to the cable joints.

### Health, Safety and Environmental

The use of the products referenced in this brochure can expose the installer to a number of hazards due to standard work practices. These may include working at height, working in confined spaces, working in excavated trenches and working with electricity.

It is the responsibility of the installer to ensure that all legal requirements are met; particularly where licensed and/or authorised staff are required for electrical wiring and that the codes of practice of Workplace New Zealand are followed.

Marley offer a take back scheme for any off-cuts or scrap of their pipe systems to reduce the amount of waste going to landfill. To utilise this service please contact our Marley contact centre on 0800 MARLEY (0800 627 539).



PAGE  
**05**

**CONDUIT  
SYSTEMS**

**BUILDING**



PAGE  
**09**

**TRUNKING  
SYSTEMS**



PAGE  
**11**

**AIR-CON  
DUCT  
SYSTEMS**

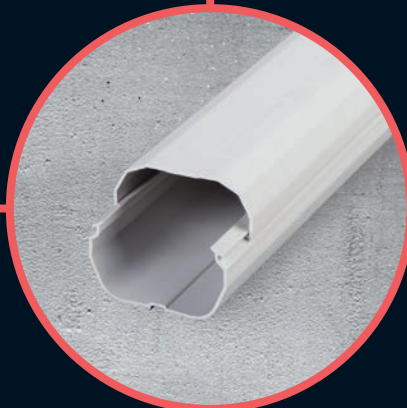

# OUR RANGE OF SYSTEMS

PAGE  
17

TECHNICAL  
INFORMATION

CIVIL

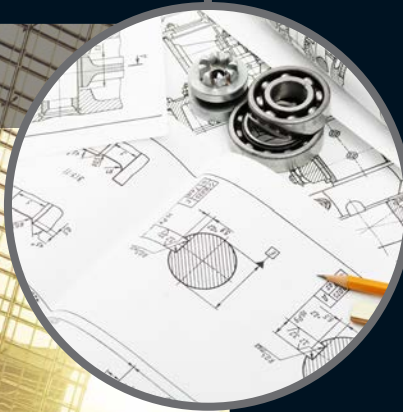

PAGE  
15

MARLEY DUCT  
SYSTEMS



PAGE  
13

ACCESS  
PITS

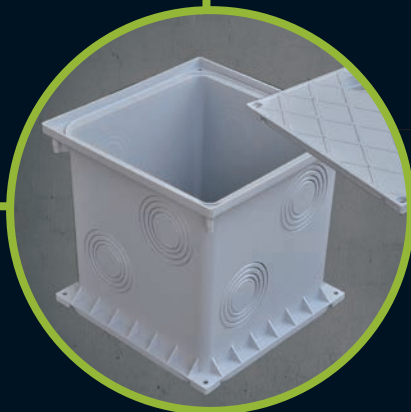

# CONDUIT SYSTEMS

## MARLEY ARMA® RIGID CONDUIT SYSTEMS

# ARMA®

ABOVE GROUND

One conduit solution for  
**ABOVE GROUND APPLICATIONS**



**EXTENSIVE FITTINGS RANGE**

- › Couplers & nipples
- › Adapters & reducers
- › Lock nut & rings
- › Saddles, (spacers) & clips
- › Elbow & bends
- › Inspections (elbow, tees & bends)
- › Bushes
- › Junction boxes, enclosures



**UV PROTECTION (T)**  
Long term outdoor durability

**HD**

**HEAVY DUTY 4431**  
Mechanical protection for durability against compression and impact forces



**SERVICE TEMPERATURE RANGE**  
High performance in extreme service temperatures up to 60°C and down to -15°C



**HIGH GLOSS FINISH**  
Superior scratch and soiling resistance compared to a matte finish



**GREY COLOUR MATCH**  
To match Marley fittings for a professional finish



**QUALITY OF CUT**  
Product retains shape once cut, will not deform like thinner wall product



**EXTENSIVE FITTINGS RANGE**  
For ease of install, including secure "press fit" connections



**COMPLIANCE**  
Manufactured consistently and rigorous tested to a high standard

# ARMA®

BELOW GROUND

One conduit solution for  
**BELOW GROUND APPLICATIONS**



**EXTENSIVE FITTINGS RANGE**

- › Elbow & bends
- › Couplers
- › Adapters & reducers
- › Lock nuts
- › Inspections (elbow, tees & bends)
- › Junction boxes

**HD**

**HEAVY DUTY 4431**  
Mechanical protection for durability against compression and impact forces

**A**

**CATEGORY A UNDERGROUND**  
Removes the need for additional mechanical protection (such as cable cover) - saving laying, backfilling and material costs



**SERVICE TEMPERATURE RANGE**  
High performance in extreme service temperatures up to 60°C and down to -15°C



**HIGH GLOSS FINISH**  
Superior scratch and soiling resistance compared to a matte finish



**ORANGE COLOUR MATCH**  
To match Marley fittings for a professional finish



**EXTENSIVE FITTINGS RANGE**  
For ease of install, full range of 90° plain bends and sweep bends in both 45° and 90° variants



**QUALITY OF CUT**  
Product retains shape once cut, will not deform like thinner wall product



**COMPLIANCE**  
Manufactured consistently and rigorous tested to a high standard

Marley ARMA® is a high performing, fully featured, rigid conduit system; designed for easy application based selection. All uPVC conduit products manufactured by Marley are BEP-certified, 100% recyclable and tested to meet AS/NZS 61386.21.

## PRODUCT SNAPSHOT

For more detailed technical information please see page 17.



**ARMA® ABOVE GROUND**



**ARMA® BELOW GROUND**

SIZE		
DIAMETER (mm)	20, 25, 32, 40, 50	20, 25, 32, 40, 50
LENGTH (m)	4	4
MATERIAL		
COLOUR	Grey	Orange
FORMULATION	uPVC Resin + modifiers	Polyethylene
FINISH	High Gloss	High Gloss
TEMPERATURE		
SERVICE TEMPERATURE RANGE	-15°C to 60°C	-15°C to 60°C
LINEAR CO EFFICIENT OF THERMAL EXPANSION	$7 \times 10^{-5} \text{ m}/(\text{m K})$	$7 \times 10^{-5} \text{ m}/(\text{m K})$
FITTINGS		
MARLEY COLOUR MATCH	Yes	Yes
EXTENSIVE RANGE	Yes	Yes
SOLVENT JOINT	Yes	Yes
DUTY RATING	Heavy Duty 4431	Heavy Duty 4431
DURABILITY		
BUILDING CODE	NZBC B2	NZBC B2 (Interior or concealed applications)
DUTY RATING	Heavy Duty 4431	Heavy Duty 4431
COMPRESSION RESISTANCE	HD - Rating 4	HD - Rating 4
IMPACT RESISTANCE	HD - Rating 4	HD - Rating 4
RESISTANCE TO BURNING (AS/NZS 61386)	Non flame propagating	Non flame propagating
UV RESISTANCE	Yes <sup>1</sup>	No
CHEMICAL RESISTANCE	High <sup>2</sup>	High <sup>2</sup>
COMPLIANCE		
MANUFACTURING STANDARD	AS/NZS 61386	AS/NZS 61386
ENVIRONMENTAL ACCREDITATION	BEP Certified ISO 14001	BEP Certified ISO 14001
3RD PARTY VERIFICATION	BV Lic. 2755	BV Lic. 2755

<sup>1</sup> Meets the requirements of AS/NZS5033 - Installation & Safety Requirements for Photovoltaic (PV) Arrays

<sup>2</sup> Avoid contact with ketones, esters, aromatic and chlorinated solvents

# CONDUIT SYSTEMS

## FLEXIBLE CONDUIT

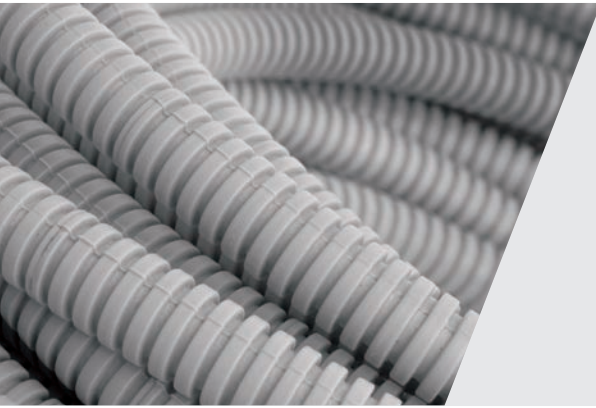

Extra Flexible

### SUPA

Marley SUPA is a flexible polypropylene conduit which offers increased flexibility and a larger internal bore than standard medium duty uPVC flexible conduit.

**SUITABLE FOR** • Tight corners • Pumps

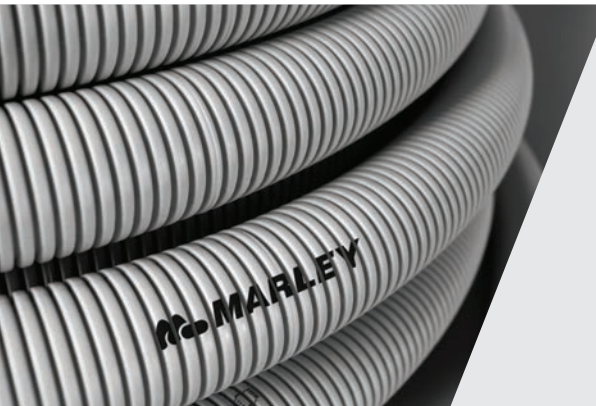

All-rounder

### EASI

Marley EASI is a versatile flexible conduit for your everyday use. It offers high compression and impact resistance to conceal your cables in and around those difficult corners.

**SUITABLE FOR** • Surface wiring • Commercial



UV protection

### SOLA

Marley SOLA is a flexible conduit which is perfect for outdoor use. It is UV resistant, provides heavy duty mechanical protection and meets the conduit requirements of standard AS/NZS 5033 for photovoltaic system installations.

**SUITABLE FOR** • Solar panel systems • Outdoors



### FITTINGS

Marley offers a full range of heavy duty conduit fittings as well as a specific flexible conduit gland.





## PRODUCT SNAPSHOT

For a quick guide on key properties for flexible conduit please see the snapshot below. For more detailed technical information please see page 22.



	SUPA	EASI	SOLA
<b>COLOURS AVAILABLE</b>	Grey	Grey	Grey
<b>MATERIAL</b>	Polypropylene	uPVC	uPVC
<b>SIZES AVAILABLE</b>	20, 25mm	20 - 50mm	20 - 32mm
<b>COMPLY WITH AS/NZS STANDARD</b>	2053	2053	2053/5033
<b>DUTY RATING**</b>	Very light duty	Medium duty	Heavy duty
<b>COMPRESSION RESISTANCE**</b>	Low	Medium	High
<b>IMPACT RESISTANCE**</b>	Medium	High	High
<b>LONG-TERM OUTDOOR USE</b>	No	No	Yes
<b>TEMPERATURE RANGE**</b>	-5°C to +60°C	-5°C to +60°C	-5°C to +60°C
<b>BEP CERTIFIED</b>	N/A	Yes	Yes
<b>MARLEY SOLVENT NEEDED TO JOIN</b>	No – use specialist adhesive	Yes	Yes
<b>CHEMICAL RESISTANCE</b>	High*	High*	High*
<b>SUITABLE FITTINGS</b>	Yes	Yes	Yes

\* Avoid contact with ketones, esters, aromatic and chlorinated solvents

\*\* As per manufacturing standard AS/NZS 2053

# TRUNKING SYSTEMS

## MINI & MAXI TRUNKING



**Full range**

### MINI TRUNKING

Mini trunking is suitable for concealing surface cables within new-build and refurbishment applications. It is designed to be aesthetically appealing whilst providing protection for indoor and busy areas. It offers security for keeping your cables concealed, as well as being user-friendly to access the cables in the future. A full range of compatible fittings in each size are available to complete your trunking system.

**SUITABLE FOR** • Alarm wiring • Data installations • Offices

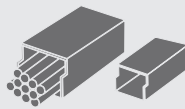

**Large capacity**

### MAXI TRUNKING

Maxi trunking is an efficient option for concealing and protecting surface cables in applications which require larger cable-carrying capacity. Complete your trunking system with a range of compatible fittings offering quick and easy installation. Maxi trunking is the perfect solution for an unobtrusive and secure cable management system for your electrical installations.

**SUITABLE FOR** • Industrial • Agricultural • Commercial



### FITTINGS

Marley offer a range of compatible fittings for your trunking system – couplings, corners angles, end pieces and side tees.

Marley Trunking and fittings are manufactured from high quality uPVC, to provide cable management solutions for building fit-outs. Made for indoor and outdoor use, it is highly UV resistant and has a range of features for security and accessibility. It is light weight for easy handling and meets the durability requirements of the New Zealand Building Code.

## PRODUCT SNAPSHOT

For a quick guide on key properties for trunking please see the snapshot below. For more detailed technical information please see page 26.

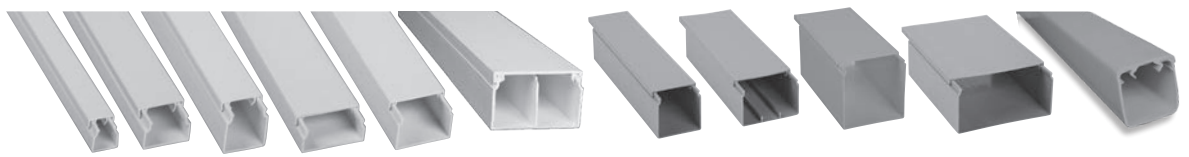

### MINI TRUNKING

### MAXI TRUNKING

<b>COLOURS AVAILABLE</b>	White Brown	Grey
<b>MATERIAL</b>	uPVC	uPVC
<b>SIZES AVAILABLE***</b>	16 - 40mm	50 - 150mm
<b>DUTY RATING*</b>	Light Duty	Heavy Duty
<b>IMPACT RESISTANCE*</b>	Medium	High
<b>NON-FLAMMABLE*</b>	Yes	Yes
<b>UV RESISTANT</b>	White – high Brown – low	Moderate
<b>TEMPERATURE RANGE*</b>	0°C to +60°C	0°C to +60°C
<b>COMPLY WITH AS/NZS STANDARD</b>	4296	4296
<b>CHEMICAL RESISTANCE</b>	High**	High**
<b>SUITABLE FITTINGS</b>	Yes	Yes

\* As per manufacturing standard AS/NZS 4296

\*\* Avoid contact with ketones, esters, aromatic and chlorinated solvents

\*\*\* Range of depths available

# AIR-CON DUCT SYSTEMS

## DUCT & FLEXI DUCT



UV protection

### AIR-CON DUCT

Designed for New Zealand conditions which call for high impact, strength and both indoor and outdoor use. With a high gloss and colour retention rate, Marley Air-Con duct is an aesthetically pleasing choice for your installation.

- SUITABLE FOR**
- Heat pump installations
  - Air-Conditioning installations

## INDEPENDENT WEATHERING TEST RESULTS

In an independent weathering test, various brands of Air-Con duct available in New Zealand were exposed to 1,000 hours of UV light and condensation testing.

Marley Air-Con duct had the least amount of colour change; indicating the **highest resistance to weathering in NZ conditions.**

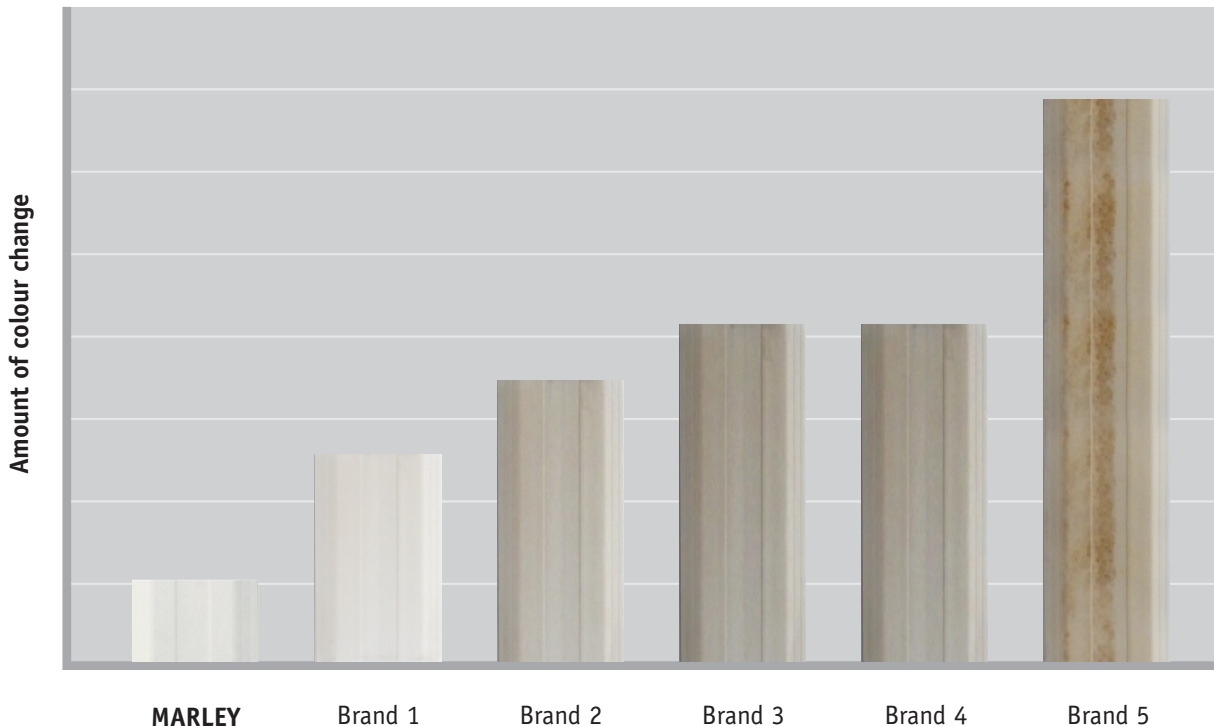

\*Source: 'UV/ Condensation testing of PVC ducting materials' – Felix Research Laboratories, May 2011. Report # 1008079.11

Marley Air-Con Duct offers a high quality system to carry and protect cables for use in heat pump and air-conditioner installations.

## PRODUCT SNAPSHOT

For a quick guide on key properties for Air-Con duct systems please see the snapshot below.



### AIR-CON DUCT

<b>COLOURS AVAILABLE</b>	Ivory
<b>MATERIAL</b>	uPVC
<b>SIZE AVAILABLE</b>	80mm
<b>IMPACT RESISTANCE</b>	High
<b>UV RESISTANT</b>	Yes
<b>TEMPERATURE RANGE</b>	0°C to +60°C
<b>BEP CERTIFIED</b>	Yes
<b>CHEMICAL RESISTANCE</b>	High*
<b>SUITABLE FITTINGS</b>	Yes

\*Avoid contact with ketones, esters, aromatic and chlorinated solvent

# ACCESS PITS

## EASY ACCESS TO YOUR CABLE JOINTS



### 1. ANTI-SLIP TRAFFICABLE LID



With watertight rubber gasket

### 2. ELECTRICAL IDENTIFICATION



Signifies that live cables are enclosed

### 3. WATERTIGHT HERMETIC SCREWING SYSTEM



For water and dust protection (IP67)

### 4. VARIOUS SIZED KNOCK-OUT OUTLETS



(sides and bottom)

### 5. OUTLET

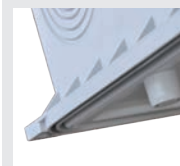

For condensation gathering and discharge

### 6. PITS HAVE PRE-CUT BASES AND CAN BE STACKED AS RISERS



(hermetic screwing system applies to pit connection)

The Marley electrical access pit is designed to provide quick easy access to your cable jointing. There are various sized knock-outs available, as well as an anti-slip trafficable lid and electrical identification to signify that live cables are enclosed.

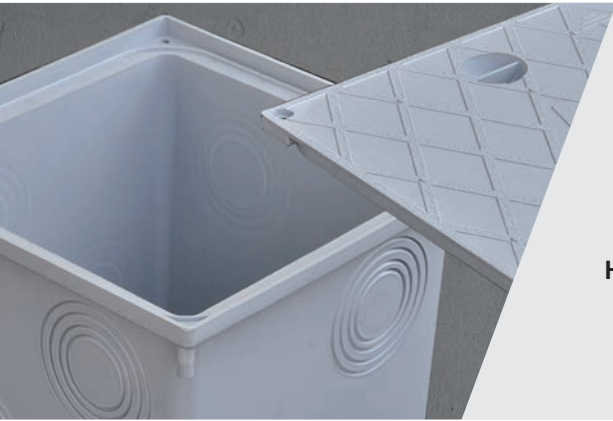

**High quality**

#### ACCESS PITS

The 250×250mm electrical access pit is non-conductive, resistant to chemicals and high impact resistant with a watertight hermetic screwing/lid system that can be made inaccessible to unauthorised persons.

Should you require one, Marley also offer a range of stormwater access pits and lids.



#### ACCESS PIT

<b>COLOURS AVAILABLE</b>	Grey
<b>MATERIAL</b>	Polypropylene
<b>IP RATING</b>	67
<b>LOAD RESISTANCE RATING (EN124)</b>	15KN (max); 1.5 tonne
<b>UV RESISTANT</b>	Yes
<b>TEMPERATURE RANGE</b>	-5°C to +50°C
<b>CHEMICAL RESISTANCE</b>	High*
<b>KNOCKOUT SIZES uPVC CONDUIT</b>	40, 50mm
<b>KNOCKOUT SIZES POLYETHYLENE</b>	40, 50, 63, 75mm

\*Avoid contact with ketones, esters, aromatic and chlorinated solvent

# MARLEY DUCT SYSTEMS

## MARLEY DUCT & BENDS (RIGID & CONTINUOUS)



**Durability**

### MARLEY RIGID DUCT (POWER & COMMUNICATION)

Marley rigid duct is manufactured from high quality uPVC, ensuring a long design life to protect power, communication and fibre optic cables. It offers high impact and compression resistance, making it suitable for trenched applications. Marley Rigid Duct is approved by major telecommunication and power authorities.

**SUITABLE FOR** • Trenched applications • Industrial Sites • Road Side



**Flexibility**

### MARLEY CONTINUOUS PE DUCT (POWER & COMMUNICATION)

Marley's complete range of polyethylene (PE) continuous duct provides high quality protection for power, communication and fibre optic cable installations. It is designed for use with directional drilling, trench-less and long-run open trench applications. It is also approved by major telecommunication and power authorities.

**SUITABLE FOR** • Directional drilling • Sub-duct applications



### MARLEY RIGID DUCT BENDS (POWER AND COMMUNICATION)

Marley offer a full range of durable uPVC duct bends to suit your installation needs. Various radii and angles are available.

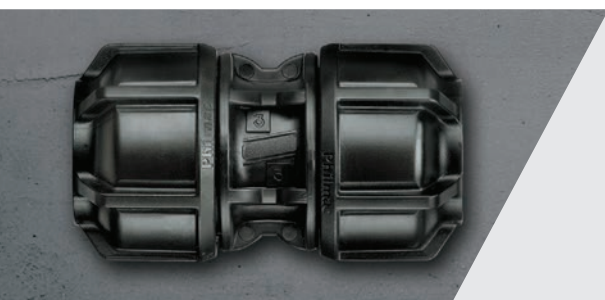

### MARLEY CONTINUOUS PE DUCT FITTINGS (POWER & COMMUNICATION)

Marley provide a full range of Philmac compression and Friatec electrofusion fittings designed for use with polyethylene pipe systems.



Marley Rigid and Continuous Duct Systems are designed to provide a cost effective solution for underground installations of power and communication cables. Available in larger sizes to carry large and/or multiple cables, including a range of colours and duty ratings to suit all applications.

## PRODUCT SNAPSHOT

For more detailed technical information please see page 27.

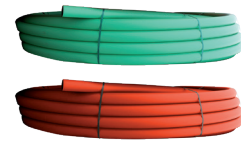

MARLEY POWER DUCT SYSTEMS  
MARLEY COMMUNICATION DUCT SYSTEMS

MARLEY POWER PE DUCT SYSTEMS  
MARLEY COMMUNICATION PE DUCT SYSTEMS

SIZE		
DIAMETER (mm)	32, 40, 50, 65, 80, 100, 150	22, 25, 40, 50, 63, 90, 110, 125, 140, 160
LENGTH (m)	6 (rigid)	50, 100, 150, 200, 500, 1000 (coil)
MATERIAL		
COLOUR <sup>1</sup>	Orange, Green, White, Salmon	Orange, Green, Red, Salmon
FORMULATION	uPVC Resin + modifiers	Polyethylene
FINISH	Matte Finish	Matte Finish
TEMPERATURE		
SERVICE TEMPERATURE RANGE	-15°C to 60°C	0°C to 60°C
LINEAR CO EFFICIENT OF THERMAL EXPANSION	7 x 10 <sup>-5</sup> m/(mK)	17 x 10 <sup>-5</sup> m/(mK)
FITTINGS		
MARLEY COLOUR MATCH <sup>1</sup>	Orange, Green	
EXTENSIVE RANGE	Yes	
JOINT	Solvent (SJ) Rubber Ring Joint (RJJ)	Electrofusion/compression
DUTY RATING <sup>2</sup>	Heavy Duty 4431 Medium Duty 3331	SDR11-SDR17
DURABILITY		
BUILDING CODE	NZBC B2	NZBC B2 (Interior or concealed applications)
DUTY RATING <sup>2</sup>	Heavy Duty 4431 Medium Duty 3331 No Duty Rated	Heavy Duty Medium Duty
COMPRESSION RESISTANCE	HD - Rating 4 MD - Rating 3	HD MD
IMPACT RESISTANCE	HD - Rating 4 MD - Rating 3	HD MD
RESISTANCE TO BURNING	Non flame propagating (AS/NZS 61386)	Non flame propagating
UV RESISTANCE	White Duct only	N/A
CHEMICAL RESISTANCE	High <sup>3</sup>	High <sup>3</sup>
COMPLIANCE		
MANUFACTURING STANDARD	AS/NZS 61386 AS/NZS 1260	AS/NZS 4130
ENVIRONMENTAL ACCREDITATION	BEP Certified ISO 14001	BEP Certified - N/A ISO 14001
3RD PARTY VERIFICATION	BV Lic. 2755	

<sup>1</sup> Both rigid and continuous cable duct are available in custom colours. Minimum order quantities and lead time apply

<sup>2</sup> Duty rating varies on size and customer requirements, please contact Marley for more information

<sup>3</sup> Avoid contact with ketones, esters, aromatic and chlorinated solvent

## Marley ARMA™ Rigid Conduit Systems

### 1) PRODUCT SPECIFICATION

Marley ARMA rigid conduit and fittings are manufactured from selected PVC resin and impact modifiers. Marley ARMA Rigid Conduit and fittings are manufactured in accordance with AS/NZS 61386.21 and carry the Bureau Veritas Licence Number 2755.

Marley ARMA conduit is classified as Heavy Duty (4431) for resistance to compression and impact forces at temperatures -15 to 60°C.

Marley ARMA fittings are also Heavy Duty rated.

#### WEATHER DURABILITY

**Marley ARMA Above Ground Conduit (Grey):**

Has been developed to meet the durability and weather performance of the New Zealand Building Code B2. Marley ARMA Above Ground Conduit is manufactured to meet the requirements of AS/NZS 61386.21. It is also UV stabilised to meet the conduit suitability requirements for AS/NZS 5033 (Installation and safety requirements for photovoltaic (PV) arrays).

**Marley ARMA Below Ground Conduit (Orange):**

Uses the same weatherable impact modifier as Marley ARMA Above Ground Conduit but is not recommended for long term exposure to UV radiation. It does meet the durability requirements of New Zealand Building Code B2 for interior or concealed applications.

#### RESISTANCE TO BURNING

Marley ARMA Rigid Conduit systems is classified by AS/NZS 61386.21 as being a 'non-flame propagating' conduit.

#### CHEMICAL RESISTANCE

Marley ARMA Rigid Conduit Systems are highly resistant to common corroding agents such as acids and alkalis however they should not be used if likely to be exposed to solvents such as ketones, esters, aromatic and chlorinated hydrocarbons.

#### RESISTANCE TO EXPANDED POLYSTYRENE INSULATION (EPS)

Marley ARMA Rigid Conduit systems is suitable for use in contact with EPS insulation and building panels. The phenomenon of plasticizer migration that can occur when PVC insulated cables are in contact with EPS does not occur with Marley ARMA Rigid Conduit systems, and the conduit provides a suitable protection between the cable and the EPS.

### 2) DESIGN DETAILS

#### TEMPERATURE AND EXPANSION

It is recommended that the continuous service temperature does not exceed +60°C or fall below -15°C.

PVC has a relatively high co-efficient of thermal linear expansion and allowance should be made for this. It is recommended that a minimum of 0.7mm movement per metre of length per 10°C change in temperature should be provided for. Long runs require flexible couplings on each standard length, especially if the run is likely to be subjected to wide temperature variations. Failure to provide for this can result in pipes buckling and/or joints breaking. To ensure that the flexible coupling functions correctly, saddles should be fixed not more than 150mm either side of the coupling.

Saddles should not be tightened to the extent as to prevent longitudinal movement of the pipe. Where there are wide temperature variations conduit clips are recommended, with the true expansion being calculated to ensure adequate movement is allowed for.

CHANGE IN TEMPERATURE °C	CHANGE IN LENGTH OF 4 METRE LENGTH (mm)
15	4.2
20	5.6
25	7.0
30	8.4
35	9.8
40	11.2

**Example 1:** Using the above table for an example of a 12 metre run installed in a roof space during winter with an ambient temperature of 2°C and an expected summer ambient temperature of 27°C.

- Allow for 25°C change in temperature.
- Therefore with a 25°C change in temperature, the change in pipe length will be 7.0mm for a 4m length of conduit.
- 7.0mm x 3 lengths of conduit = 21.0mm potential change in length.



## IP CLASSIFICATION

The IP rating (or International Protection Rating, also referred to as Ingress Protection Rating) consists of the letters IP followed by two digits. It is defined by IEC 60529 and classifies the degree of protection against the intrusion of a solid object (eg hands, fingers, screwdriver and dust) as the first numeral and protection against water as the second numeral.

### PROTECTION AGAINST INGRESS OF SOLID OBJECT

### PROTECTION AGAINST HARMFUL INGRESS OF WATER

REQUIREMENTS		PRESCRIPTIONS	
0	No protection	0	No protection
1	Full penetration of 50mm diameter sphere not allowed. Contact with hazardous parts not permitted	1	Protected against vertically falling drops of water. Limited ingress permitted
2	Full penetration of 12.5mm diameter sphere not allowed. The jointed test finger shall have adequate clearance from hazardous parts	2	Protected against vertically falling drops of water with enclosure tilted 15° from the vertical. Limited ingress permitted
3	The access probe of 2.5mm diameter shall not penetrate	3	Protected against sprays to 60° from the vertical. Limited ingress permitted
4	The access probe of 1mm diameter shall not penetrate	4	Protected against water splashed from all directions. Limited ingress permitted
5	Limited ingress of dust permitted	5	Protected against jets of water. Limited ingress permitted
6	Totally protected against ingress of dust	6	Protected against strong jets of water. Limited ingress permitted
		7	Protected against the effects of immersion between 15cm and 1m
		8	Protected against long periods of immersion under pressure

As per AS/NZS 3000 Appendix G

IP ratings are often specified for projects and it is important to know that generally any IP rating higher than the one specified will be sufficient for the application. For example, if IP56 is specified you could use IP66, but not IP65 (as the 2nd numeral indicating water protection is too low).

A fully solvent cemented Marley ARMA Rigid Conduit System will provide an IP rating of 67. A full list of the IP ratings for various Marley ARMA Rigid Conduit Systems are shown in the table to the right.

### MARLEY ARMA RIGID CONDUIT SYSTEM

### IP RATING

Fully solvent cemented Marley ARMA Rigid Conduit System	IP67
Marley ARMA Access Pit 250mmx250mm (1SD4469)	IP67
Marley ARMA circular junction boxes (screwed lid solvent cemented or with 'o'rings)	IP66
Marley ARMA Enclosure Boxes (with gaskets)	IP55
Marley ARMA circular junction boxes & inspection fittings (screwed lid without solvent cement or 'o' rings)	IP53

## CABLE CARRYING CAPACITY

The maximum amount of cables that may be enclosed in a conduit shall be an amount which permits installation of the cable without damage, as per NZECP 28 clause 5.6. The number of cables that can be installed in a circular conduit is determined by the ratios of the cross sectional areas of the enclosure and the cable, as follows:

$$\text{Number of cables} = \frac{\text{Internal cross-section of enclosure}}{\text{Cross-sectional area of cable}} \times \text{space factor}$$

The space factor as per AS/NZS 3000 Appendix C6 recognises the reduction of space available from the circular geometry of the cables and enclosures.

### NUMBER OF CABLES

### SPACE FACTOR

FOR ONE CABLE IN ENCLOSURE	0.5
FOR TWO CABLES IN ENCLOSURE	0.33
FOR THREE OR MORE CABLES IN ENCLOSURE	0.4

Provided permission by Standards New Zealand under license 001143.

### MINIMUM INTERNAL CROSS SECTIONAL AREA OF ENCLOSURE (mm<sup>2</sup>)

NOMINAL SIZE	MEAN OD (mm)	HEAVY DUTY AREA
20	19.7 - 20.0	189
25	24.7 - 25.0	330
32	31.7 - 32.0	568
40	39.7 - 40.0	924
50	49.7 - 50.0	1486

Refer next page for reference tables to determine the max. number of cables allowable in a conduit by cable type.

# CONDUIT SYSTEMS TECHNICAL INFORMATION

The following tables show examples of the maximum number of cables that may be used in Marley ARMA rigid conduit by cable type. The number of cables does not consider the effects the grouping of cables may have on temperature rise, voltage drop or current carrying capacity and reference should be made to AS/NZS 3008 for de-rating factors. This maximum number is based on short runs of conduit free of obstructions with minimal changes in direction. Where this is not the case the number of cables should be reduced or the conduit size increased to ensure that the maximum pulling tension is not exceeded.

## GUIDE TO THE MAXIMUM NUMBER OF SINGLE-CORE SHEATHED CABLES INSTALLED IN CONDUIT

CABLE SIZE (mm <sup>2</sup> )	HEAVY DUTY uPVC CONDUIT				
PVC/PVC V90	20	25	32	40	50
1	6	10	17	28	45
1.5	5	8	14	23	38
2.5	3	6	11	17	28
4	2	4	7	12	20
6	1	3	6	10	17
10	1	2	4	7	11
16	1	1	3	5	8
XLPE/PVC	20	25	32	40	50
25	0	1	1	3	5
35	0	1	1	2	4
50	0	1	1	1	3
70	0	0	1	1	2
95	0	0	1	1	1
120	0	0	0	1	1
150	0	0	0	1	1
185	0	0	0	0	1
240	0	0	0	0	1
300	0	0	0	0	1



GUIDE TO THE MAXIMUM NUMBER OF TWO-CORE AND EARTH CABLES INSTALLED IN CONDUIT

CABLE SIZE (mm <sup>2</sup> )	HEAVY DUTY uPVC CONDUIT				
	20	25	32	40	50
PVC/PVC V90					
1.5	1	1	2	4	7
2.5	1	1	1	3	6
4	0	1	1	2	4
6	0	1	1	2	4
PVC/PVC V75					
10	0	0	1	1	2
16	0	0	1	1	1
25	0	0	0	1	1
PVC/PVC V90 FLAT					
1	1	3	5	9	15
1.5	1	3	5	9	14
2.5	1	1	3	6	10
4	1	1	2	4	7
6	1	1	2	3	6
10	0	1	1	2	4
16	0	0	1	1	2

GUIDE TO THE MAXIMUM NUMBER OF FOUR-CORE AND EARTH CABLES INSTALLED IN CONDUIT

CABLE SIZE (mm <sup>2</sup> )	HEAVY DUTY uPVC CONDUIT				
	20	25	32	40	50
PVC/PVC V90					
1.5	1	1	1	3	5
2.5	0	1	1	2	4
4	0	1	1	1	3
6	0	0	1	1	2
PVC/PVC V75					
10	0	0	0	1	1
16	0	0	0	1	1
25	0	0	0	0	1
35					

## 3) INSTALLATION DETAILS

### FIXING

Where conduits are to be surface mounted, ensure you secure it to the building fabric with the correct size saddles or conduit clips using zinc plated or stainless steel screws into wood or masonry anchors. Galvanised or stainless steel screws may be preferred in exterior or corrosive environments while galvanized nails may be used for securing saddles in most interior applications.

When conduit is being installed on a horizontal plane, it is recommended that saddles be fixed at intervals not exceeding 600mm and 1000mm in a vertical plane. Allow provision for expansion and contraction where required. (See page 17 for temperature & expansion details)

Where conduits are to be embedded in concrete the conduit should be secured from being displaced during pouring and vibrating by securing to the formwork or reinforcing.

### BENDING

Marley ARMA Rigid Conduit can be bent in sizes 20 and 25mm. This is achieved by:

1. Inserting the correct size of bending spring.
2. Heating the conduit by briskly rubbing the area to be bent with a piece of cloth.
3. It is advisable to bend slightly beyond the angle required and then ease back to the desired position. This relieves stress and reduces the tendency for the conduit to straighten after bending.

There is a risk of kinking and damage to the bending spring if the conduit is bent too fast. Having completed the bend it should not be forced backwards as this can result in damage to both the conduit and the bending spring.

The recommended minimum radius for all diameters is not less than 6 times the conduit diameter. This will result in a swept bend that is more easily formed and less likely to kink or have a reduction in bore.

In addition, reference should also be made to the cable manufacturers recommendations regarding the maximum radius that the cable in use can be bent to.

CONDUIT OD (mm)	MINIMUM BEND RADIUS (mm)
20	120
25	150
32	200



## UNDERGROUND WIRING SYSTEMS

The selection of the correct size and classification of conduit for the application is important in order to comply with the appropriate regulations and standards.

Marley ARMA Rigid Conduit Systems are suitable for use in underground installations and industrial applications where compression and impact resistance is required. They are not recommended where they are likely to be subjected to severe mechanical abuse.

Marley ARMA Rigid Conduit is rated and only ranged as Heavy Duty conduit.

Medium Duty Conduit is not ranged due to the increased labour cost and time incurred with installing additional mechanical protection.

In order to comply with AS/NZS 3000 Australian/New Zealand Wiring Rules the following guidelines apply:

**Category A:** underground wiring systems may use heavy duty conduit without further mechanical protection.

**Category B:** underground wiring systems may use medium duty conduit with additional mechanical protection.

This additional mechanical protection shall:

1. Be placed not more than 75mm above the wiring system.
2. Be not less than 150mm wide.
3. Overlap the system by at least 40mm on each side.
4. Consist of one or a combination of the following :
  - Precast concrete slabs having a thickness not less than 40mm and a classification of not less than grade 20 in accordance with AS 3600 or NZS 3104
  - Concrete slabs cast on-site having a thickness of not less than 100mm
  - A continuous concrete pour having a thickness of not less than 75mm
  - Fibrous cement slabs having a thickness of not less than 12mm
  - Bricks manufactured specifically for the protection of electric cables
  - Polymeric cable cover strip complying with AS 4702
  - Other materials that offer the same degree of protection afforded by the materials in above items.

Refer to clause 3.11.4.3 of AS/NZS 3000 for additional mechanical protection requirements.

There is a requirement to identify underground wiring with orange marker tape complying with AS/NZS 2648.1 laid approximately 50% of the depth of cover above the wiring system.

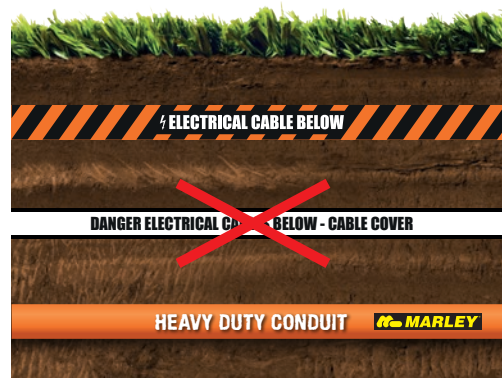

## ENCLOSURE BOXES

Marley ARMA enclosure boxes have been developed to meet the durability and weather performance requirements of the New Zealand Building Code B2. In addition they are UV stabilised.

Features:

- Lids are fitted with nickel plated screws. They are located within the gasketed area to ensure a continuing seal.
- Supplied with neoprene washers for sealing of mounting screws.
- Lightweight compared to metal enclosures.
- Larger high lid versions include zintec gear plate.
- Machining is easy with normal tools. Punching, drilling, filing, sawing and even ultrasonic welding are easily achieved.
- Rated to IP55 when installed according to Marley recommended installation instructions.



## FLEXIBLE CONDUIT

### SUPA FLEXIBLE CONDUIT

Marley SUPA is manufactured from polypropylene (PP).



### TEMPERATURE

It is suitable for applications where the temperature does not exceed +60°C or fall below -5°C.

### WEATHER DURABILITY

It meets the requirements of the NZ Building Code Approved Document B2 Clause B2.3 for use within buildings and in wall applications.

### DUTY RATING

Marley SUPA is rated as a very light duty flexible conduit.

### SUPA KEY DIMENSIONS (mm)

NOMINAL OD	MEAN OD	MINIMUM ID
20	19.85	14.1
25	24.75	18.3

### CABLE CARRYING CAPACITY

The following tables show examples of maximum number of cables that may be used in conduit by cable type. The number of cables does not consider the effects the grouping of cables may have on temperature rise, voltage drop or current carrying capacity and reference should be made to AS/NZS 3008 for de-rating factors. This maximum number is based on short runs of conduit free of obstructions with minimal changes in direction. Where this is not the case the number of cables should be reduced or the conduit size increased to ensure that the maximum pulling tension is not exceeded.

### GUIDE TO THE MAXIMUM NUMBER OF SINGLE-CORE SHEATHED CABLES INSTALLED IN FLEXIBLE CONDUIT

#### CABLE SIZE (mm<sup>2</sup>)

#### SUPA FLEXIBLE CONDUIT

	20	25	32	40
PVC/PVC V90				
1	4	7	14	23
1.5	3	6	11	19
2.5	2	4	8	14
4	1	3	6	10
6	1	2	5	8
10	1	1	3	5
16	1	1	2	4



# CONDUIT SYSTEMS TECHNICAL INFORMATION

## GUIDE TO THE MAXIMUM NUMBER OF TWO-CORE AND EARTH SHEATHED CABLES INSTALLED IN FLEXIBLE CONDUIT

CABLE SIZE (mm <sup>2</sup> )	SUPA FLEXIBLE CONDUIT			
	20	25	32	40
PVC/PVC V90	20	25	32	40
1.5	1	1	1	3
2.5	0	1	1	3
4	0	1	1	2
6	0	0	1	1
PVC/PVC V75				
10	0	0	1	1
16	0	0	0	1
25	0	0	0	1
PVC/PVC V90 FLAT				
1	1	2	4	7
1.5	1	2	4	7
2.5	1	1	3	5
4	0	1	1	3
6	0	1	1	3
10	0	1	1	1
16	0	0	1	1

## GUIDE TO THE MAXIMUM NUMBER OF FOUR-CORE AND EARTH SHEATHED CABLES INSTALLED IN FLEXIBLE CONDUIT

CABLE SIZE (mm <sup>2</sup> )	SUPA FLEXIBLE CONDUIT			
	20	25	32	40
PVC/PVC V90	20	25	32	40
1.5	0	1	1	2
2.5	0	0	1	1
4	0	0	1	1
6	0	0	1	1

## INSTALLATION

Marley SUPA is designed for use only in above ground applications.

### Fixing

Where conduits are to be surface mounted, secure to the building fabric with the correct size saddles or conduit clips using zinc plated or stainless steel screws into wood or masonry anchors. Galvanised or stainless steel screws may be preferred in exterior or corrosive environments while galvanised nails may be used for securing saddles in most interior applications.

Where it is being used in a horizontal plane it is recommend that saddles be fixed at intervals not exceeding 500mm and 1000mm in a vertical plane. Allow provision for expansion and contraction where required.

### Joining

Marley SUPA cannot be joined with PVC solvent cement. Use a conduit gland, plain to screw adaptor, or specialised silicon.

## EASI FLEXIBLE CONDUIT

Marley EASI flexible conduit is manufactured from unplasticised polyvinyl chloride (uPVC).



### TEMPERATURE

Marley EASI is suitable for applications where the temperature does not exceed +60°C or fall below -5°C.

### WEATHER DURABILITY

It meets the requirements of the New Zealand Building Code Approved Document B2 Clause B2.3 for use within buildings and in wall applications.

### DUTY RATING

Marley EASI is rated as medium duty in accordance with AS/NZS 2053.

### EASI KEY DIMENSIONS (mm)

NOMINAL OD	MEAN OD	MINIMUM ID
20	19.85	14.1
25	24.75	18.3
32	31.75	24.3
40	39.7	31.2
50	49.8	39.6

### CABLE CARRYING CAPACITY

The following tables show examples of maximum number of cables that may be used in conduit by cable type. The number of cables does not consider the effects the grouping of cables may have on temperature rise, voltage drop or current carrying capacity and reference should be made to AS/NZS 3008 for de-rating factors. This maximum number is based on short runs of conduit free of obstructions with minimal changes in direction. Where this is not the case the number of cables should be reduced or the conduit size increased to ensure that the maximum pulling tension is not exceeded.



GUIDE TO THE MAXIMUM NUMBER OF SINGLE-CORE SHEATHED CABLES INSTALLED IN FLEXIBLE CONDUIT

CABLE SIZE (mm <sup>2</sup> )	EASI FLEXIBLE CONDUIT			
	20	25	32	40
PVC/PVC V90				
1	4	7	14	23
1.5	3	6	11	19
2.5	2	4	8	14
4	1	3	6	10
6	1	2	5	8
10	1	1	3	5
16	1	1	2	4

GUIDE TO THE MAXIMUM NUMBER OF TWO-CORE AND EARTH SHEATHED CABLES INSTALLED IN FLEXIBLE CONDUIT

CABLE SIZE (mm <sup>2</sup> )	EASI FLEXIBLE CONDUIT			
	20	25	32	40
PVC/PVC V90				
1.5	1	1	1	3
2.5	0	1	1	3
4	0	1	1	2
6	0	0	1	1
PVC/PVC V75				
10	0	0	1	1
16	0	0	0	1
25	0	0	0	1
PVC/PVC V90 FLAT				
1	1	2	4	7
1.5	1	2	4	7
2.5	1	1	3	5
4	0	1	1	3
6	0	1	1	3
10	0	1	1	1
16	0	0	1	1

GUIDE TO THE MAXIMUM NUMBER OF FOUR-CORE AND EARTH SHEATHED CABLES INSTALLED IN FLEXIBLE CONDUIT

CABLE SIZE (mm <sup>2</sup> )	EASI FLEXIBLE CONDUIT			
	20	25	32	40
PVC/PVC V90				
1.5	0	1	1	2
2.5	0	0	1	1
4	0	0	1	1
6	0	0	1	1

INSTALLATION OF EASI FLEXIBLE CONDUIT

Although it is designed for use above ground it can also be used in buried applications. Please refer to the wiring installation standard AS/NZS 3000 for guidance.

Fixing

Where conduits are to be surface mounted, secure to the building fabric with the correct size saddles or conduit clips using zinc plated or stainless steel screws into wood or masonry anchors. Galvanised or stainless steel screws may be preferred in exterior or corrosive environments while galvanized nails may be used for securing saddles in most interior applications.

Where being used in a horizontal plane it is recommend that saddles be fixed at intervals not exceeding 600mm and 1000mm in a vertical plane. Allow provision for expansion and contraction where required.

Where conduits are to be embedded in concrete the conduit should be secured from being displaced during pouring and vibrating by securing to the formwork or reinforcing.



## SOLA FLEXIBLE CONDUIT

Marley SOLA flexible conduit is manufactured from unplasticised polyvinyl chloride (uPVC).



### TEMPERATURE

Marley SOLA is suitable for applications where the temperature does not exceed +60°C or fall below -5°C.

### WEATHER DURABILITY

It meets the requirements of the New Zealand Building Code Approved Document B2 Clause B2.3 for use within buildings and in wall applications. Marley SOLA conduit is suitable for external use.

### DUTY RATING

Marley SOLA is rated heavy duty in accordance with AS/NZS 2053 and is suitable for use in photovoltaic installations in accordance with AS/NZS 5033.

### SOLA KEY DIMENSIONS (mm)

NOMINAL OD	MEAN OD	MINIMUM ID
20	19.85	12.7
25	24.75	16.5
32	31.75	22.0

### INSTALLATION OF SOLA FLEXIBLE CONDUIT

Although it is designed for use above ground it can also be used in buried applications. Please refer to the wiring installation standard AS/NZS 3000 for guidance.

#### Fixing

Where conduits are to be surface mounted, secure to the building fabric with the correct size saddles or conduit clips using zinc plated or stainless steel screws into wood or masonry anchors. Galvanised or stainless steel screws may be preferred in exterior or corrosive environments while galvanized nails may be used for securing saddles in most interior applications.

Where being used in a horizontal plane it is recommend that saddles be fixed at intervals not exceeding 600mm and 1000mm in a vertical plane. Allow provision for expansion and contraction where required.

Where conduits are to be embedded in concrete the conduit should be secured from being displaced during pouring and vibrating by securing to the formwork or reinforcing.

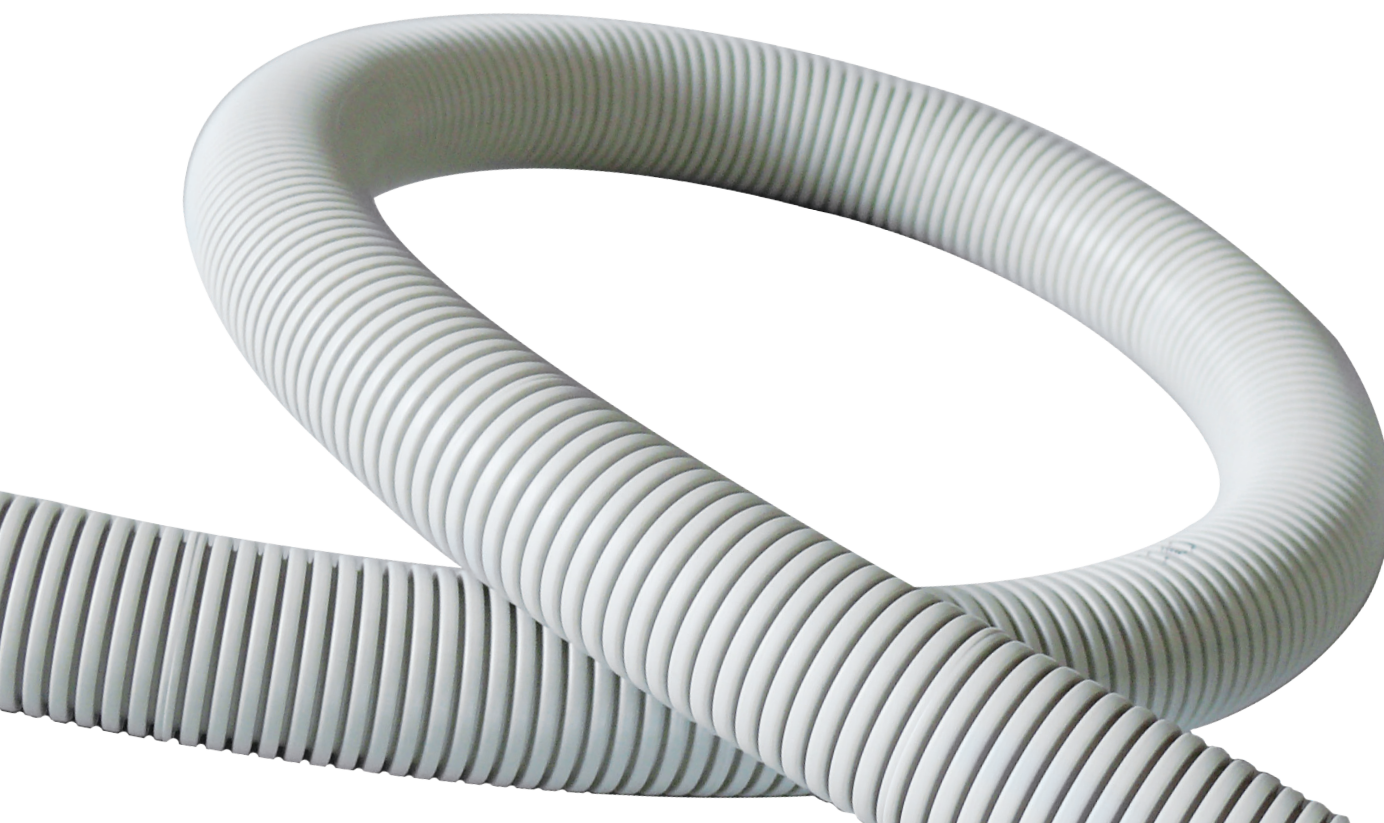

## MINI & MAXI TRUNKING

Marley trunking and fittings are manufactured from uPVC and are manufactured in accordance with AS/NZS 4296 Cable Trunking Systems.

### LIDS

Marley trunking features double-lock clip tops for security and accessibility.

To remove the lid; start with a peeling action from one end. Where lids are butted together, carefully insert a screw driver blade to enable an initial start to be made. Attempts to remove the lid in one motion along its length or forcing it with a tool under the edge will fail to remove the lid and may damage the edge of the trunking.

### WEATHER DURABILITY

The grey and white Marley uPVC trunking range contains titanium dioxide to provide high UV performance.

N.B. Brown Marley trunking is designed for indoor use.

N.B. Grey Marley maxi trunking has a moderate UV performance.

Marley trunking may be painted using acrylic paints which will enhance the long term weatherability when installed outside.

### INSTALLATION OF TRUNKING

All installation should be in accordance with the Electrical Regulations and AS/NZS 3000 Wiring Rules.

The following is a guide only:

1. When planning the route to be taken, consider drops to sockets, switches and other fittings.
2. Where angles and tees are required the trunking base ends should be mitre cut at 45° to provide a neat join.

3. Fix the main body of the trunking by drilling through the base and screwing into position with flathead wood or metal screws. Oversize holes should be drilled to allow for expansion/contraction and large washers used under the screw to provide suitable support.
4. Fixings should be at maximum 500mm centres for mini trunking and 1000mm centres for maxi trunking. At low levels where trunking may be liable to impact or for uneven surfaces this should be reduced to 300mm centres.
5. Once the base has been fixed the wiring can then be installed (hold in place by using short offcuts of lid).
6. Cut lids 10mm shorter where fittings are to be used to allow fitting to snap over base.
7. Once the wiring is in place, snap the lid into place by starting at one end, applying even pressure and work along the length (removing temporary wire supports) as you go. Then snap on lids of fittings.
8. Allowances should be made for expansion/contraction. Do not push trunking hard against fittings. Allow a 7mm gap every 10 metres for every 10°C rise in temperature.

As per AS/NZS 3000\* part 3.10.3.9 Cable trunking installations shall comply with the following:

- a) Covers shall be able to be opened, where practicable.
- b) Covers shall be continuous when passing through walls or floors.
- c) Cable trunking shall be accessible through its entire length.
- d) Cables installed in a trunking shall not rely on any readily removable cover for support.
- e) Non-hygroscopic trunking shall be used to enclose insulated, unsheathed conductors.
- f) Live parts of accessories mounted on cable trunking shall be arranged so that basic protection is provided, in accordance with Clause 1.5.4.



## CABLE DUCT

Marley Power and Communication Duct is manufactured for the conveyance and protection of electrical, communication and fibre optic cables. It is available as either a rigid or continuous duct and is primarily intended for buried applications.

For identification purposes, Marley Power Duct is typically coloured orange. Marley Communication Duct is typically coloured green, white, salmon or red. In some instances, other colours may exist for customer specific projects.

Marley NZ manufactures a range of communication duct, including **Chorus NZ Ltd** branded duct to comply with Chorus NZ specification. Chorus branded product can only be sold to **Chorus Approved installers and their approved subcontractors** for use in Chorus NZ Projects. For non Chorus related installation work, use **Marley Communication Duct** branded products

## MARLEY POWER DUCT SERIES

Marley Power Duct is manufactured from high quality uPVC and is available in 6 metre lengths with a socket on one end.

Marley Power Duct Bends are fabricated from similar PVC duct material, socketed both ends. The standard method of joining the duct is by solvent cement to provide leak free joints – refer to page 29 for the procedure. Chorus NZ Approved Communication duct product in 50mm and 110mm are supplied with a rubber ring jointing system.

Sizes 32, 40, 50 and 65 are manufactured to the outside diameters of AS/NZS 1260. Sizes 80, 100 and 150mm are manufactured to the outside diameters of AS/NZS 61386.

### MARLEY POWER DUCT - MINIMUM CROSS SECTIONAL AREA (mm<sup>2</sup>)

NOMINAL SIZE	MEAN OD (mm)	NON RATED AREA	MEDIUM DUTY AREA	HEAVY DUTY AREA
32	36.2 – 36.5	799		
40	42.8 – 43.1	1152		
50	55.7 – 56.0	2019		
65	68.7 – 69.1	3147		
80	82.3 – 82.7		4596	4501
100	110.0 – 110.4		8528	8107
150	160.0 – 160.5		18098	17296

Marley Power and Communication Duct Systems are intended for buried application by open trenching and it is important that all safety requirements are in place when the duct is being installed. Refer page 2.

Heavy Duty (HD) and Medium Duty (MD) Marley Power Duct may be used in a Category A or B underground wiring system as defined in clause 3.11.3 of AS/NZS 3000 as appropriate. For those projects utilising a specific design, Marley have a range of different duty ratings.

For a Category A system, Marley Power Duct (HD) may be used without further protection and for Category B systems, Marley Power Duct (MD) may be used with additional mechanical protection.

This protection may be:

- Precast concrete slabs having a thickness of no less than 40mm and a classification of not less than grade 20 in accordance with AS 3600 or NZS 3000
- Concrete slabs cast on site with a thickness no less than 100mm
- A continuous concrete pour having a minimum thickness of 75mm
- Fibrous cement slabs having a minimum thickness of 12mm
- Bricks manufactured specifically for the protection of electric cables
- Polymeric cable cover strip complying with AS 4702

This protection shall be:

- Placed no more than 75mm above the wiring system
- Not less than 150mm wide
- Overlap the wiring system by at least 40mm on each side

The minimum depth of cover required for Category A and B systems is as per Table A below:

### DEPTH OF COVER FOR CAT A & B UNDERGROUND WIRING SYSTEM

SURFACE COVERING ON GROUND	LOCATION OF WIRING SYSTEM	
	WITHIN BUILDING CONFINES	EXTERNAL OF BUILDING CONFINES
>75mm Poured Concrete	0mm depth	300mm depth
<75mm Poured Concrete or No Surface Covering	500mm depth	500mm depth

Note: The depth of cover applies to the upper surface of the ground or the bottom of any concrete laid on the surface and either the top of the wiring system or the top of the additional mechanical protection of Category B systems.

Although the pipe is coloured orange there is still a requirement to place orange marker tape complying with AS/NZS 2648.1 approximately 50% of the depth of cover above the wiring system.

It is recommended that the burial depths above also be applied to communication systems.



## MARLEY CONTINUOUS PE DUCT (POWER & COMMUNICATION)

Marley Continuous PE Duct (Power and Communication) is manufactured to the dimensions of AS/NZS 4130. It is made from high quality polyethylene and is available in lengths from 50 metres to 1000 metres depending upon the diameter of the pipe. This product is suitable for directional drilling and open trenches.

**Marley Power PE Duct Systems** (continuous) and **Marley Communication PE Duct Systems** (continuous) is available for Power and Communication installations.

Where the pipe is directional drilled, it is unlikely that any additional mechanical protection will be provided and therefore the system should be a Category A system and therefore heavy duty duct should be used. The covers depths are detailed in Table A above.

Lengths of duct may be joined by the use of Marley electrofusion fittings or compression fittings. Instructions for the use of these fittings can be found at [www.marley.co.nz](http://www.marley.co.nz) – search: Philmac Fittings and/or Friatec Fittings.

### SUB-DUCT MINIMUM CROSS-SECTIONAL AREA (mm)<sup>2</sup>

NOMINAL SIZE	MEAN OD (mm)	SDR	CROSS SECTIONAL AREA
20	20.0 - 20.3	11	125
25	25.0 - 25.3	11	200
32	32.0 - 32.3	13.6	330

### MARLEY CONTINUOUS PE DUCT - MINIMUM CROSS-SECTIONAL AREA (mm<sup>2</sup>)

NOMINAL SIZE	MEAN OD (mm)	SDR	AREA
40	40.0 - 40.4	17	929
50	50.0 - 50.4	17	1465
63	63.0 - 63.6	17	2324
90	90.0 - 90.9	17	4802
110	110.0 - 111.0	17	7147
125	125.0 - 126.1	17	9227
140	140.0 - 141.2	17	11308
160	160.0 - 161.5	17	15128

Medium Duty
  Heavy Duty

## TOWING LOADS

Continuous duct is predominantly installed using ‘no dig’ methods which require the duct to be pulled through the ground. This requires a pulling load to be applied to the duct in order to draw it forward and the load requirement will be influenced by; the length and straightness of the run, the friction between the pipe, and the surrounding ground and diameter of the pipe.

Where possible, the minimum towing load to achieve the installation should be used and in no case should the loads in the following table be exceeded. Exceeding these loads may result in a reduction of the diameter and wall thickness of the duct.

When slip lining it is recommended that for long strings, a pipe relaxation period of at least 24 hours is allowed before grouting or making permanent tie-in joints.

Where a pipe of a greater wall thickness (lower SDR) is being used to those shown in the table then the same guidelines can safely be used.

### MARLEY PIPE SIZE AND TOWING LOADS

PIPE SIZE	SDR	20°C TONNES
20	11	0.08*
25	11	0.12*
32	13.6	0.27*
40	17	0.22
50	17	0.32
63	17	0.5
90	17	1.1
110	17	1.6
125	17	2.1
140	17	2.5
160	17	3.4

\* It is recommended that the smaller diameters be pulled by hand.



\*Provided permission by Standards New Zealand under license 001143.

The above information is provided permission by Standards New Zealand under license 001143.

### SOLVENT JOINTING PROCEDURES

Assembly of solvent joints is easy, reliable and efficient as long as the following simple procedure is followed.

#### SAFETY PRECAUTIONS WITH SOLVENT WELD JOINTING

- Make sure there is adequate ventilation. Forced ventilation may be necessary inside buildings, in confined trenches and manholes.
- Solvent cement and priming fluids are highly flammable. Store them in a cool place away from heat, flames and sparks. Do not smoke while using them.
- Keep the containers tightly sealed when not in use.
- Do not add thinners or solvents to Marley Gold or Marley Clear Solvent Cement or Marley Joint Primer.
- Do not use old solvent cement that has become jelly like or expired.
- Do not use dirty or contaminated brushes or rags.

Solvent cement spilt onto skin should be washed off immediately with soap and water. Should solvent cement affect the eyes, flush with cool clean water for at least 15 minutes. If solvent cement or primer is swallowed, induce vomiting. Safety and First Aid instructions on the container should be followed.

Wash hands thoroughly after use.

#### SPECIAL CONSIDERATIONS

Workmanship and correct procedures are essential for solvent joints if water tightness and durability are to be assured. Solvent jointing should only be carried out in dry conditions above 5°C, by appropriately trained personnel.

Solvent cement jointing is a welding not a gluing process. Priming fluid and Marley Solvent Cements soften the surfaces, so when they are brought together the two PVC surfaces bond together.

It is important that the spigot provides an interference fit in the socket. Do not attempt to make a joint that does not achieve an interference fit when dry. The actual area of contact between the spigot and the socket may only be a few millimetres. The spigot end must be square to make a good joint. Before proceeding, make sure that the spigots and sockets are not cracked or damaged.

To make successful solvent weld joints on PVC pipe, the following procedure is recommended:

- Minimise the number of joints.
- Introduce no deflections or strain on pipe fittings or joints.
- Check pipes have not been damaged during transit.
- Cut the pipes with only a fine tooth hack saw. Ensure the pipe spigot is cut square, taking care not to chip or crack the pipe. Remove all burrs from the inside. Make a 15° chamfer to the outside of the cut end of the pipe to remove any other burrs.
- Mark the insertion depth on the pipe spigot. The insertion depth is equivalent to the depth of the corresponding joint socket. The pipe should be marked with a soft pencil or felt pen which does not damage the pipe.
- Dry assemble all pipes and joints. Check that all joints have a full interference fit. Interference fit means that the pipe spigot should not be able to fully penetrate the socket up to the insertion mark without force.
- Mark the pipe and spigot for alignment by drawing a horizontal line across the joint with a soft pencil or felt pen.
- Ensure the pipe spigot and socket are free of dust, dirt and grease, by wiping with a clean cloth clipped in methylated

spirits or Marley primer.

- Coat the socket and the spigot sparingly with either Marley Gold or Marley Clear Solvent Cement.
- Immediately push together firmly to evenly spread the solvent cement and wipe off any excess Solvent Cement. Do not handle the joint for approximately 5 minutes and allow 10 hours of drying time before any rough handling or testing.

#### RUBBER RING JOINTING

Check the socket, spigot and rubber ring are clean and that the ring is sitting in the socket so that the flap is facing into the pipe. Apply Marley jointing lubricant to the spigot of the pipe and ensuring the pipe is in line with the socket push the pipe into the socket.



## MATERIAL PROPERTIES

Marley supply a wide range of products in uPVC, polypropylene and polyethylene. Please refer to the table below for performance data “typical” of these materials.

PROPERTY	UNITS	uPVC	POLYPROPYLENE	POLYETHYLENE
CO-EFFICIENT OF THERMAL EXPANSION	$\times 10^{-5} \text{ m}/(\text{mK})$	7	17	17
SPECIFIC HEAT	$\text{JK}^{-1}\text{kg}^{-1}$	1250	1800	1900
THERMAL CONDUCTIVITY	$\text{w}/\text{m}^{\circ}\text{C}$	.16	.22	.45
FLAMMABILITY		Self extinguishing Non flame propagating	Non flame propagating	Non flame propagating
SPECIFIC GRAVITY		1.46	.96	.95
WATER ABSORPTION	%	0.5	<0.1	<0.1
VICAT SOFTENING TEMPERATURE	$^{\circ}\text{C}$	80	114	120
MAX SERVICE TEMPERATURE	$^{\circ}\text{C}$	60	60	60
MINIMUM SERVICE TEMPERATURE	$^{\circ}\text{C}$	-15	-5	0
DIELECTRIC STRENGTH	$\text{kV}/\text{mm}$	14	30	22
VOLUME RESISTIVITY	$\Omega\text{M}$	$1.2 \times 10^{14}$	$>10^{14}$	$>10^{13}$
SURFACE RESISTIVITY	$\Omega\text{M}$	$10^{15}$	$>10^{16}$	$>10^{15}$
DIELECTRIC CONSTANT	1MHz	2.7	2.2	2.3
DISSIPATION FACTOR	1MHz	.025	.0004	.0003

Note: Above values are indicative only.

 FOLLOW US @MARLEYNEWZEALAND

**DISCLAIMER**

This technical catalogue has been compiled by Marley New Zealand Limited ("The Company") to promote better understanding of the technical aspects of the Company's products to assist users in obtaining from them the best possible performance. The technical catalogue is supplied subject to acknowledgment of the following conditions:

The technical catalogue is protected by Copyright and may not be copied or reproduced in any form or by any means in whole or in part without prior consent in writing by the Company. Product specifications, usage data and advisory information may change from time to time with advances in research and field experience. The Company reserves the right to make such changes at any time without notice. Correct usage of the Company's products involve engineering judgements which cannot be properly made without full knowledge of all the conditions pertaining to each specific installation. The Company expressly disclaims all and any liability to any person whether supplied with this publication or not in respect of anything and of the consequences of anything done or omitted to be done by any such person in reliance whether whole or partial upon the whole or any part of the contents of this publication. No offer to trade, nor any conditions of trading, are expressed or implied by the issue or content of this manual. Nothing herein shall override the Company's Conditions of Sale, which may be obtained from the Registered Office or any Sales Office of the Company. This technical catalogue is and shall remain the property of the Company, and shall be surrendered on demand to the Company. Actual colours may vary slightly from those shown. For a more accurate colour comparison, please request a product sample.

MAR3440 October 2018

OUR PARTNERS



**Master Plumbers**  
Representing Excellence



**Construction Marketing Services**

For more information: **0800 MARLEY (0800 627539)**

[www.marley.co.nz](http://www.marley.co.nz)

an *Aliaxis* company

Cable Management

