



# 990MF Series

Locks & latches



Fire Rated: Tested on fire door assemblies in accordance with Australian Standards, refer fire door manufacturer for specific approval details

Legge's 990MF Series of multi-functional mortice locks and latches have been designed specifically to meet the requirements of the Australasian market. With an extensive range of lock functions, the 990MF Series has the right function to meet your specific needs. The 990MF Series is ideally suited for commercial, industrial, institutional and government buildings, where durability and security are of major importance.

The 990MF Series has a high purity die cast zinc alloy case to provide rigidity and precision. Major internal components are made of either stainless steel or sintered steel/copper alloy to provide durability and strength.

The final product has been rigorously tested in accelerated wear tests and testimony to the quality of the 990MF Series is shown through the extensive use in the Australian and New Zealand markets.

## Features

- Multi-function case allows easy conversion of a vestibule lock function (inside handle free) to a combination lock function (both handles locked) by a simple external operation
- Reversible stainless steel latch adjusts for inwards/outwards opening and left/right hand without case disassembly
- Standard lock suitable for doors 32mm to 50mm thick. Extended cylinders, spindles and strike plates available to accommodate thicker doors and wider jambs
- 990MF case will accept bolt-through fixing for 50.8mm diagonal and 38mm-41mm horizontal fixing door furniture
- Follower will accept 7.6mm-8mm furniture spindles, with no adjustment necessary
- A threaded pin is used for secure cylinder retention
- Designed to be compatible with most electric strikes
- The 10 year warranty provides specifiers and users with assured quality and performance

# Specification guide

Function	Sub-function	Finish	Backset
Vestibule..... L9V	refer following pages	Chrome plate..... CP	60mm..... standard
Combination..... L9C		Polished brass..... PB	70mm..... 70
CD series..... L9CD		Satin chrome plate..... SCP	89mm..... 89
Nightlatch..... L9N			127mm..... 127
Deadlock..... L9D			
Sliding door..... L9S			

1. Function  
Select the desired function e.g. Vestibule lock ..... L9V
2. Sub-function  
Select the required sub-function e.g. V31 Office/classroom locking latch ..... L9V31
3. Finish  
Select the desired finish e.g. Satin chrome plate ..... L9V31SCP
4. Backset  
Nominate non-standard backset if required e.g. 70mm ..... L9V31SCP70

## Legge 990 V Series Vestibule Lock

- Inside handle always operative
- Automatic deadlocking by closing door
- Reversible bolt and function

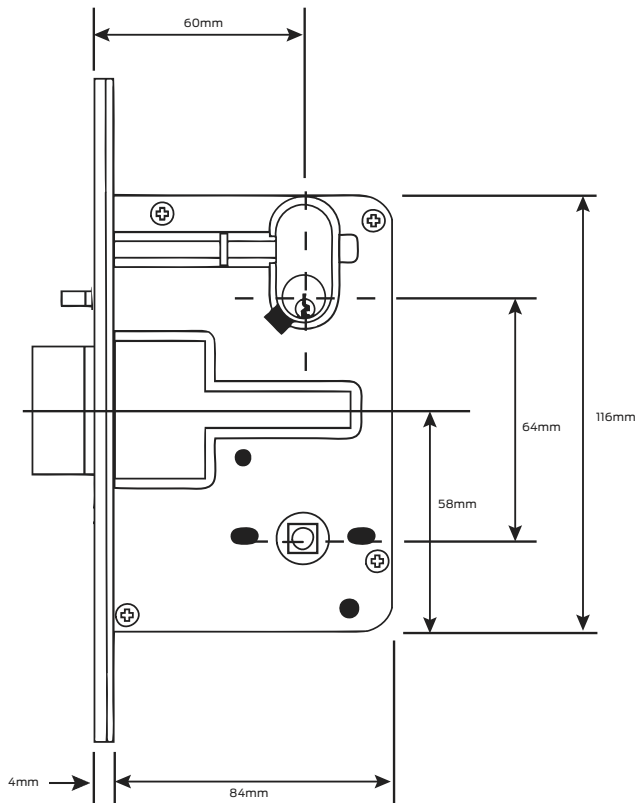

### Specifications

<b>Door type</b>	Timber or metal
<b>Door thickness</b>	32mm to 50mm standard, extended cylinders, spindles and strike plates available to accommodate thicker doors
<b>Lock case</b>	High purity zinc alloy
<b>Outer forend</b>	Stainless steel or brass
<b>Inner forend</b>	Stainless steel
<b>Bolt</b>	Stainless steel
<b>Sub-bolt</b>	Stainless steel
<b>Spindles</b>	2 split spindles 32mm
<b>Strike plate</b>	Stainless steel or brass 45mm standard, 40mm, 50mm, 60mm, 70mm, 80mm & 90mm available
<b>Backsets</b>	60mm standard, 70mm, 89mm and 127mm available
<b>Key cylinder</b>	C4 6 pin keyway standard, Schlage C6 pin keyway optional, Schlage E6 pin keyway optional, Schlage Everest D keyway optional
<b>Finishes</b>	Chrome plate, polished brass, satin chrome plate
<b>Warranty</b>	10 year mechanical

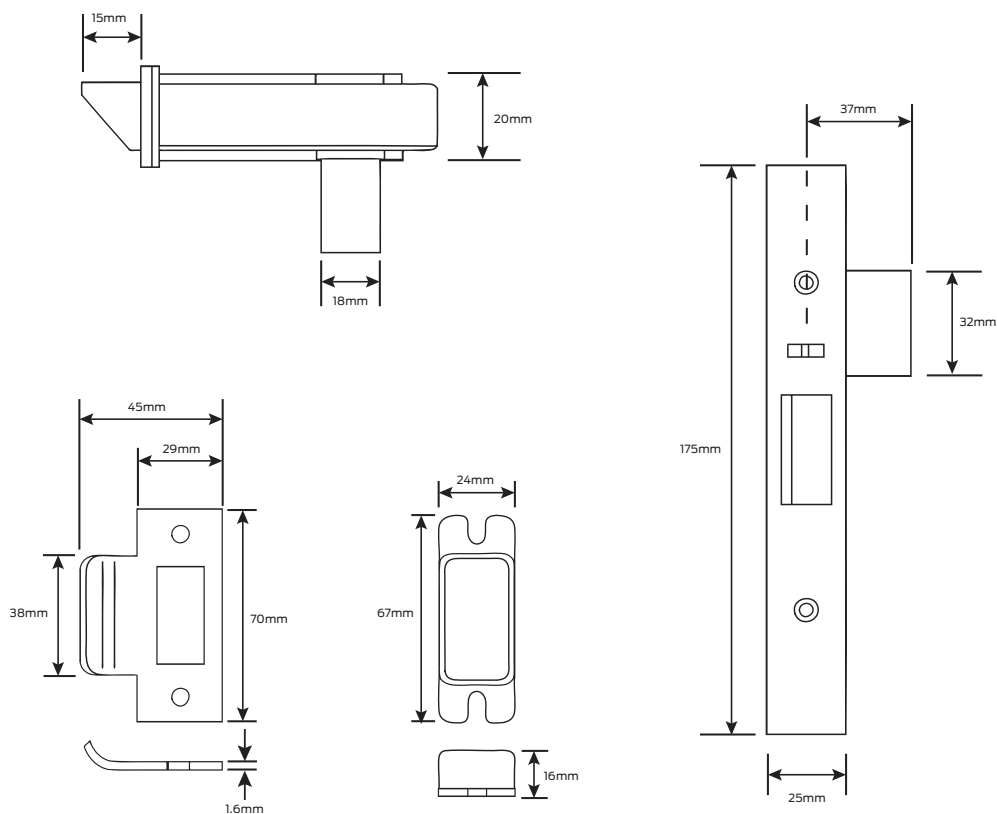

# Legge 990 V Series Vestibule Lock

## Sub-function

## Cams and adaptors

### V1 (RH) V2 (LH) - Vestibule lock

Outside: Key operates bolt at all times. Handle operative except when locked by inside turn  
 Inside: Turn locks and unlocks outside handle. Handle always operative

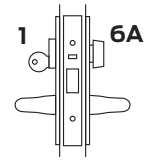

### V7 (RH) V8 (LH) - Exterior & exit lock

Outside: Key operates bolt at all times. Handle operative except when locked by inside key  
 Inside: Key locks and unlocks outside handle. Handle always operative

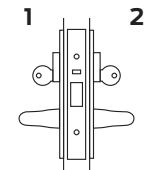

### V9 (RH) V10 (LH) - Storeroom lock

Outside: Key operates bolt at all times. Handle always inoperative  
 Inside: Handle always operative

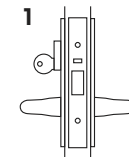

### V11 (RH) V12 (LH) - Single action lock

Outside: Key operates bolt at all times  
 Inside: Handle always operative

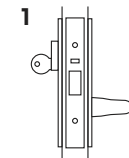

### V21 (RH) V22 (LH) - Vestibule lock

Outside: Operative except when locked by outside key or inside turn  
 Inside: Turn locks and unlocks outside handle. Handle always operative

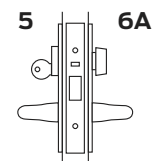

### V25 (RH) V26 (LH) - Anti-lockout Lock

Outside: Key locks and unlocks handle. Handle operative except when locked by outside key or inside turn. Closing door or operating inside handle will unlock mechanism and make the outside handle operative  
 Inside: Turn locks and unlocks outside handle. Handle always operative

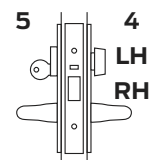

## Legge 990 V Series Vestibule Lock

### Sub-function

### Cams and adaptors

#### V29 (RH) V30 (LH) - Classroom lock

Outside: Key locks and unlocks handle. The reverse turn of the key retracts the bolt.  
 Handle operative except when locked by outside key  
 Inside: Handle always operative

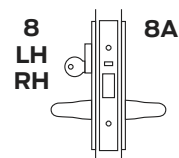

#### V31 (RH) V32 (LH) - Office/classroom locking latch

Outside: Key locks and unlocks handle. Handle operative except when locked by outside key  
 Inside: Handle always operative

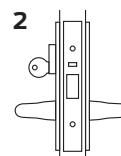

#### V41 (RH) V42 (LH) - Exterior & exit lock

Outside: Handle operative except when locked by inside turn  
 Inside: Turn locks and unlocks outside handle. Inside handle always operative

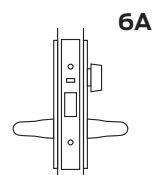

#### V49 (RH) V50 (LH) - Exterior & exit lock

Outside: Handle operative except when locked by inside key  
 Inside: Key locks and unlocks outside handle. Inside handle always operative

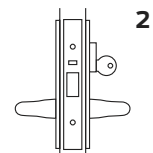

#### V55 (RH) V56 (LH) - Exit latch

Outside: Handle always inoperative  
 Inside: Handle always operative

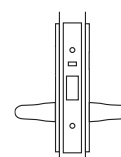

# Legge 990 C Series Combination Lock

- Key or turn locks or unlocks both handles simultaneously
- Automatic deadlocking by closing door
- Reversible bolt and function

## Specifications

<b>Door type</b>	Timber or metal
<b>Door thickness</b>	32mm to 50mm standard, extended cylinders, spindles and strike plates available to accommodate thicker doors
<b>Lock case</b>	High purity zinc alloy
<b>Outer forend</b>	Stainless steel or brass
<b>Inner forend</b>	Stainless steel
<b>Bolt</b>	Stainless steel
<b>Sub-bolt</b>	Stainless steel
<b>Spindles</b>	2 split spindles 32mm
<b>Strike plate</b>	Stainless steel or brass 45mm standard. 40mm, 50mm, 60mm, 70mm, 80mm & 90mm available
<b>Backsets</b>	60mm standard, 70mm, 89mm and 127mm available
<b>Key cylinder</b>	C4 6 pin keyway standard, Schlage C6 pin keyway optional, Schlage E6 pin keyway optional, Schlage Everest D keyway optional
<b>Finishes</b>	Chrome plate, polished brass, satin chrome plate
<b>Warranty</b>	10 year mechanical

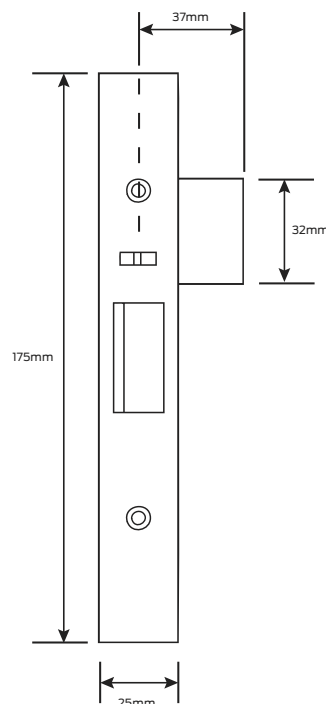
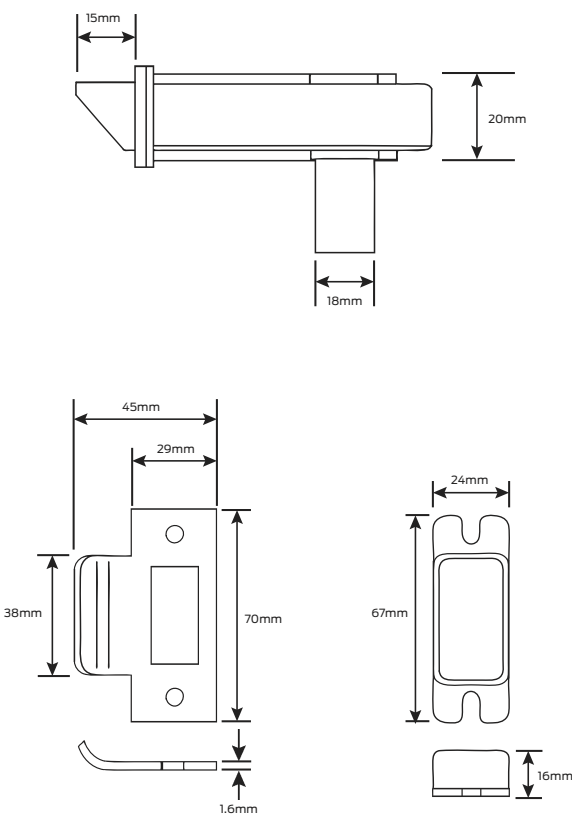
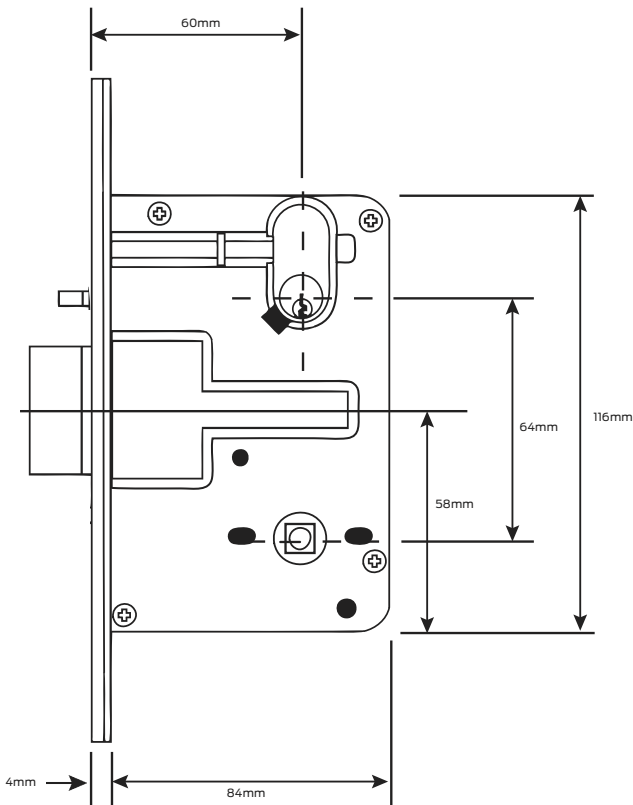

# Legge 990 C Series Combination Lock

**Sub-function**

**Cams and adaptors**

**C1 (RH) C2 (LH) - Entry lock**

Outside: Key operates bolt at all times. Both handles operative except when locked by inside turn  
 Inside: Turn locks and unlocks both handles

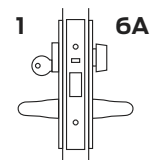

**C7 (RH) C8 (LH) - Glass door lock**

Outside: Key operates bolt at all times. Both handles operative except when locked by inside key  
 Inside: Key locks and unlocks both handles

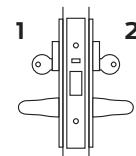

**C21 (RH) C22 (LH) - Entry lock**

Outside: Both handles operative except when locked by outside key or inside turn  
 Inside: Turn locks and unlocks both handles

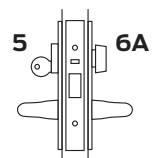

**C23 (RH) C24 (LH) - Turn entry lock**

Outside: Both handles operative except when locked by outside key  
 Inside: Turn operates bolt at all times

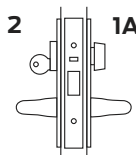

**C27 (RH) C28 (LH) - Glass door lock (double cylinder)**

Outside: Handle operative except when locked by outside or inside key  
 Inside: Handle operative except when locked by inside or outside key

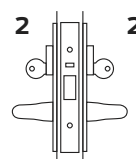

# Legge 990 C Series Combination Lock

## Sub-function

## Cams and adaptors

### C31 (RH) C32 (LH) - Glass door lock (Single cylinder)

Outside: Both handles operative except when locked by outside key

Inside: Handle operative except when locked by outside key

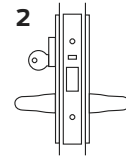

### C33 (RH) C34 (LH) - Privacy latch

Outside: Operative except when locked by inside turn. Emergency button unlocks both handles

Inside: Turn locks and unlocks both handles

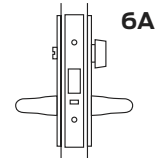

### C41 (RH) C42 (LH) - Exterior privacy latch

Outside: Both handles operative except when locked by inside turn

Inside: Turn locks and unlocks both handles

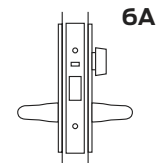

### C49 (RH) C50 (LH) - Exterior lock

Outside: Both handles operative except when locked by inside key

Inside: Key locks and unlocks both handles

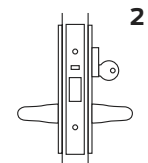

### C57 (RH) C58 (LH) - Passage latch

Outside: Always operative

Inside: Always operative

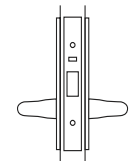



## Legge 990 CD Series Combination Lock/Dual Deadlocking

- Key or turn locks or unlocks both handles simultaneously
- Automatic deadlocking by closing door
- Additional deadlocking engaged when locked
- Reversible bolt and function
- Can only be locked when door is in closed position

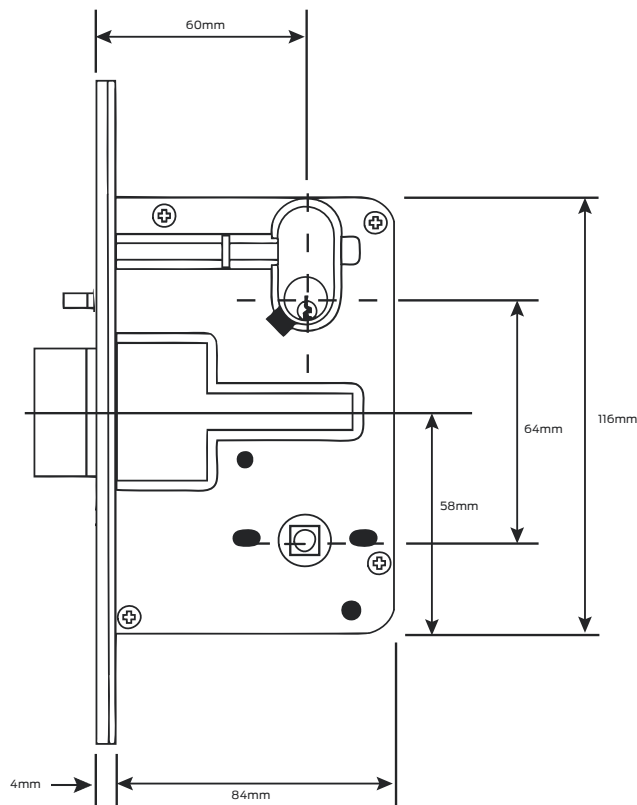

### Specifications

<b>Door type</b>	Timber or metal
<b>Door thickness</b>	32mm to 50mm standard. Extended cylinders, spindles and strike plates available to accommodate thicker doors
<b>Lock case</b>	High purity zinc alloy
<b>Outer forend</b>	Stainless steel
<b>Inner forend</b>	Stainless steel
<b>Bolt</b>	Stainless steel
<b>Sub-bolt</b>	Stainless steel
<b>Spindles</b>	2 split spindles 32mm
<b>Strike plate</b>	Stainless steel or brass 45mm standard. 50mm, 60mm, 70mm, 80mm & 90mm available
<b>Backsets</b>	60mm standard. 70mm, 89mm and 127mm available
<b>Key cylinder</b>	C4 6 pin keyway standard, Schlage C6 pin keyway optional, Schlage E6 pin keyway optional, Schlage Everest D keyway optional
<b>Finishes</b>	Chrome plate, polished brass, satin chrome plate
<b>Warranty</b>	10 year mechanical

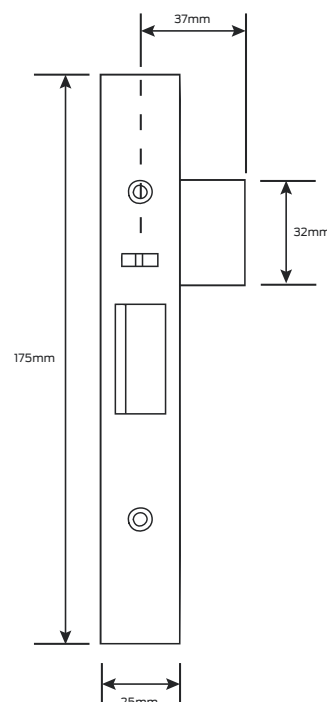
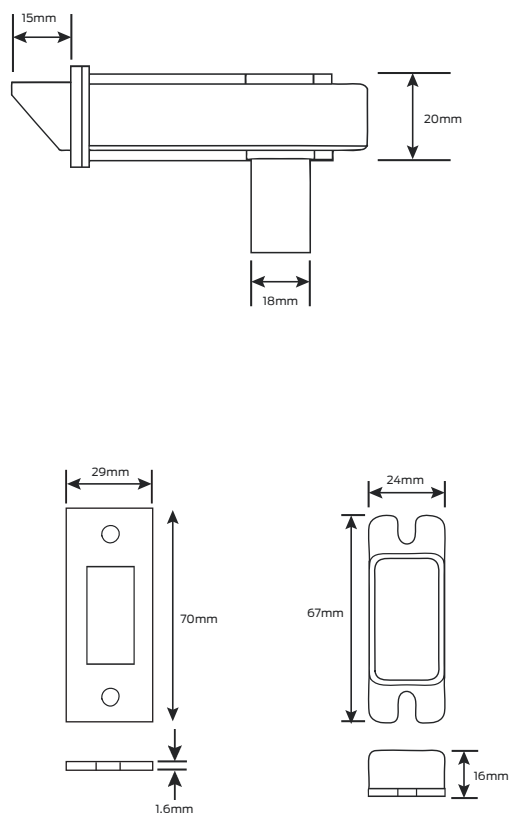

# Legge 990 CD Series Combination Lock/Dual Deadlocking

## Sub-function

## Cams and adaptors

### CD21 (RH) CD22 (LH) - Entry lock

Outside: Both handles operative except when locked by outside key or inside turn

Inside: Turn locks and unlocks both handles and disengages dual deadlocking

Caution: Locking can only be engaged when door is in closed position

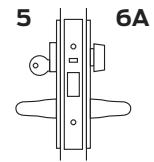

### CD27 (RH) CD28 (LH) - Glass door lock (Double cylinder)

Outside: Both handles operative except when locked by either key.

Inside: Key locks and unlocks both handle and disengages dual deadlocking

Caution: Locking can only be engaged when door is in closed position

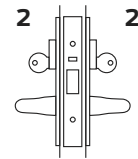

### CD31 (RH) CD32 (LH) - Glass door lock (Single cylinder)

Outside: Handle operative except when locked by outside key

Inside: Handle operative except when locked by outside key

Caution: Locking can only be engaged when door is in closed position

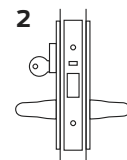

### CD41 (RH) CD42 (LH) - Exterior privacy latch

Outside: Both handles operative except when inside turn locked

Inside: Turn locks and unlocks both handles and bolt. Turn also locks bolt

Caution: Locking can only be engaged when door is in closed position

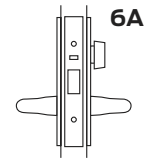

### CD49 (RH) CD50 (LH) - Glass door lock

Outside: Both handles operative except when locked by inside key

Inside: Key locks and unlocks both handles and disengages dual deadlocking

Caution: Locking can only be engaged when door is in closed position

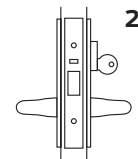

## Legge 990 N Series Nightlatch

- Latch operated by key or turn
- Automatic deadlocking by closing door
- Hold back by turn

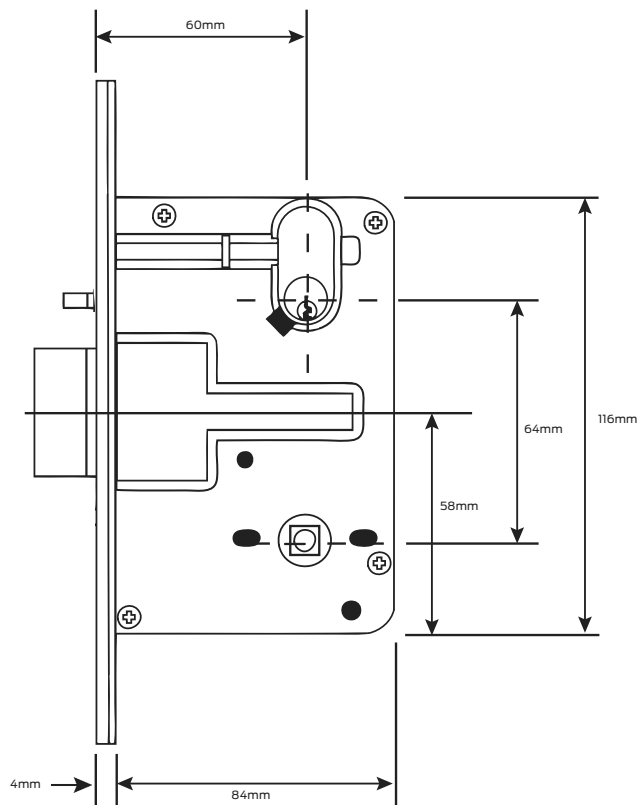

### Specifications

<b>Door type</b>	Timber or metal
<b>Door thickness</b>	32mm to 50mm standard. Extended cylinders, and strike plate available to accommodate thicker doors
<b>Lock case</b>	High purity zinc alloy
<b>Outer forend</b>	Stainless steel or brass
<b>Inner forend</b>	Stainless steel
<b>Bolt</b>	Stainless steel
<b>Sub-bolt</b>	Stainless steel
<b>Strike plate</b>	Stainless steel or brass 45mm standard. 40mm, 50mm, 60mm, 70mm, 80mm & 90mm available
<b>Backsets</b>	60mm standard. 70mm, 89mm and 127mm available
<b>Key cylinder</b>	C4 6 pin keyway standard, Schlage C6 pin keyway optional, Schlage E6 pin keyway optional, Schlage Everest D keyway optional
<b>Finishes</b>	Chrome plate, polished brass, satin chrome plate
<b>Warranty</b>	10 year mechanical

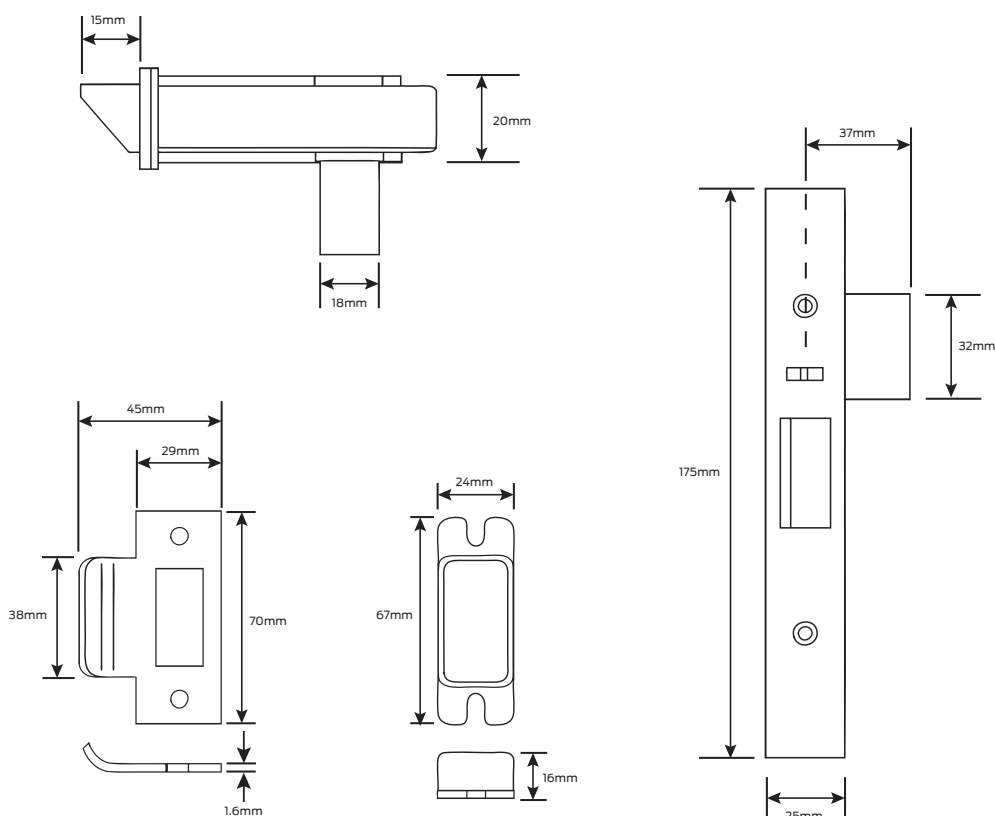

# Legge 990 N Series Nightlatch

## Sub-Function

## Cams and adaptors

### N1 (RH) N2 (LH) - Nightlatch

Outside: Key operates bolt

Inside: Turn operates bolt and hold back function

To engage hold back function, manually depress latch, rotate turn towards latch and then release latch

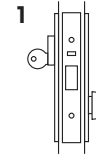

### N3 - Communicating door latch

Outside: Key operates bolt

Inside: Key operates bolt

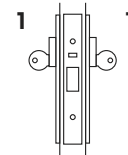

### N5 (RH) N6 (LH) - Cylinder latch

Outside: Key operates bolt

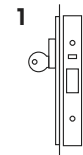

### N7 (RH) N8 (LH) - Exit door latch

Inside: Turn operates bolt and hold back function

To engage hold back function, manually depress latch, rotate turn towards latch and then release latch



### N9 (RH) N10 (LH) - Fire door nightlatch

Outside: Key operates bolt

Inside: Turn operates bolt

No hold back function

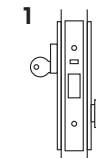

## Legge 990 D Series Deadlock

- Deadbolt operated by key or turn

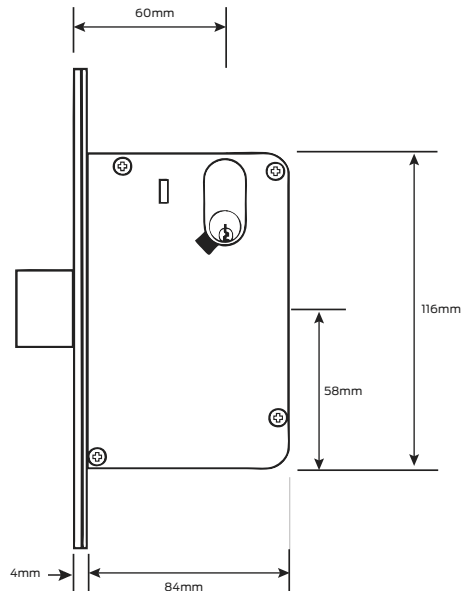

### Specifications

<b>Door type</b>	Timber or metal
<b>Door thickness</b>	32mm to 50mm standard. Extended cylinders available to accommodate thicker doors
<b>Lock case</b>	High purity zinc alloy
<b>Outer forend</b>	Stainless steel or brass
<b>Inner forend</b>	Stainless steel
<b>Bolt</b>	One piece sintered stainless steel
<b>Strike plate</b>	Stainless steel or brass
<b>Backset</b>	60mm
<b>Key cylinder</b>	C4 6 pin keyway standard, Schlage C6 pin keyway optional, Schlage E6 pin keyway optional, Schlage Everest D keyway optional
<b>Finishes</b>	Chrome plate, polished brass, satin chrome plate
<b>Warranty</b>	10 year mechanical

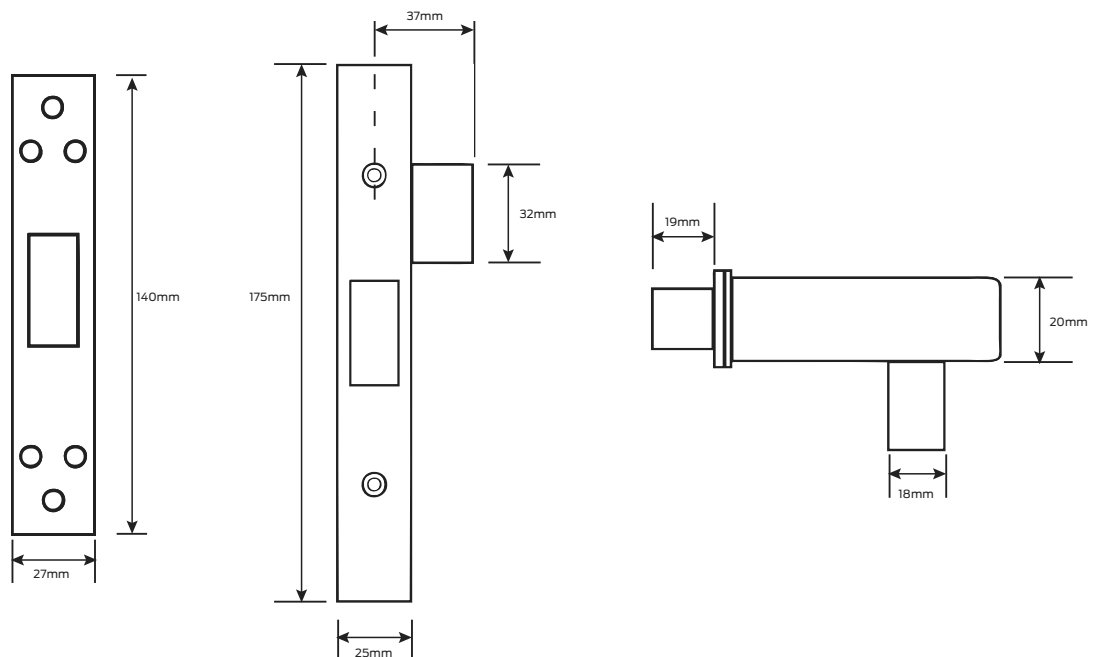

# Legge 990 D Series Deadlock

## Sub-function

## Cams and adaptors

### D1 - Entry deadlock

Outside: Key operates bolt  
 Inside: Turn operates bolt

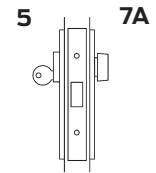

### D3 - Glass door deadlock

Outside: Key operates bolt  
 Inside: Key operates bolt

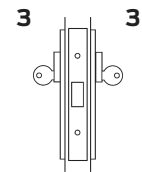

### D5 - Lock-up shop deadlock

Outside: Key operates bolt

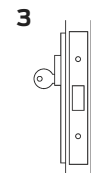

### D7 - Exit deadlock

Inside: Turn operates bolt

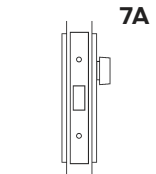

### D9 (RH) D10 (LH) - Institutional deadlock

Outside: Key operates bolt  
 Inside: Turn operates bolt but slips when key operates cylinder  
 Note: This lock is made to order and supplied with modified furniture

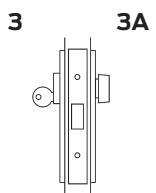

### D11 (RH) D12 (LH) - Escape deadlock

Outside: Key operates bolt  
 Inside: Turn retracts bolt only, turn cannot throw bolt

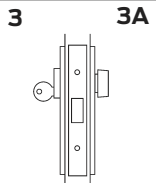

## Legge 990 S Series Sliding Door Lock

- Claw bolt operated by key or turn

### Specifications

<b>Door type</b>	Timber or metal
<b>Door thickness</b>	32mm to 50mm standard. Extended cylinders available to accommodate thick doors
<b>Lock case / chassis</b>	High purity zinc alloy
<b>Outer forend</b>	Stainless steel or brass
<b>Inner forend</b>	Stainless steel
<b>Bolt</b>	One piece sintered stainless steel
<b>Strike plate</b>	Stainless steel or brass
<b>Backsets</b>	60mm
<b>Key cylinder</b>	C4 6 pin keyway standard, Schlage C6 pin keyway optional, Schlage E6 pin keyway optional, Schlage Everest D keyway optional
<b>Finishes</b>	Chrome plate, polished brass, satin chrome plate
<b>Warranty</b>	10 year mechanical

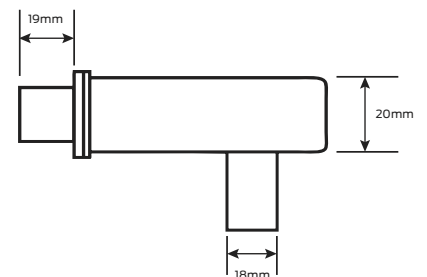
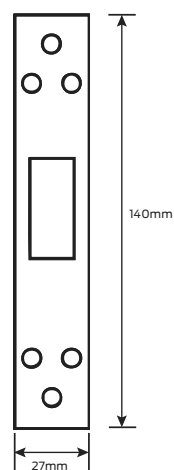
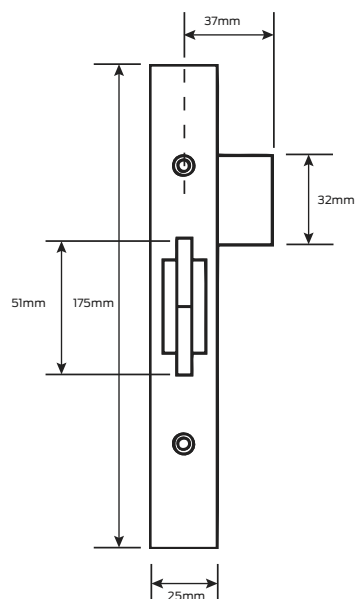
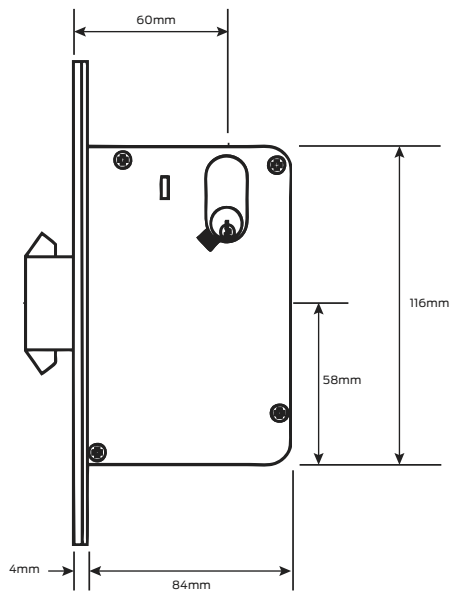

# Legge 990 S Series Sliding Door Lock

## Sub-function

## Cams and adaptors

### S1 - Sliding door lock

Outside: Key operates bolt  
 Inside: Turn operates bolt

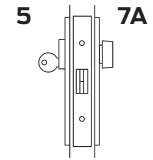

### S3 - Glass door sliding deadlock

Outside: Key operates bolt  
 Inside: Key operates bolt

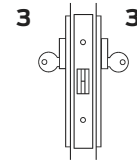

### S5 - Lock-up shop sliding door deadlock

Outside: Key operates bolt

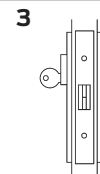

### S7 - Exit sliding door deadlock

Inside: Turn operates bolt

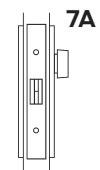

### S33 - Sliding door privacy latch

Outside: Emergency button operates bolt  
 Inside: Turn operates bolt

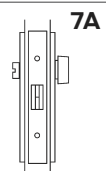



## Legge 990MF Cams and Cam Adaptors

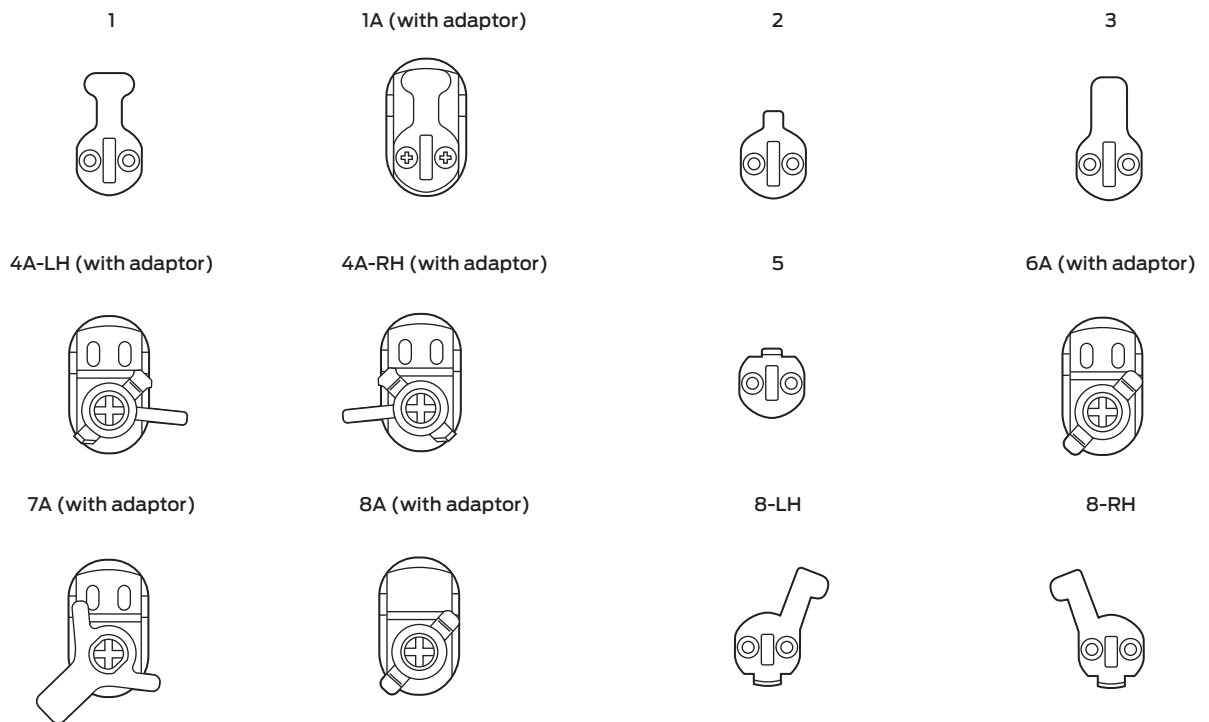

## Legge 990MF Series accessories

### R13 Rebate kit for V, C, CD, N Series

This kit adapts latches and strikes for 13mm rebated door preparations  
**Finishes:** Chrome plate, polished brass, satin chrome plate

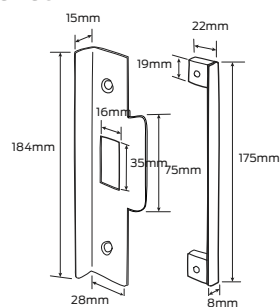

### Long lipped strike

Strikes for non-standard jambs.  
 Available in 50mm, 60mm, 70mm, 80mm & 90mm (A)  
**Finishes:** Chrome plate, polished brass, satin chrome plate

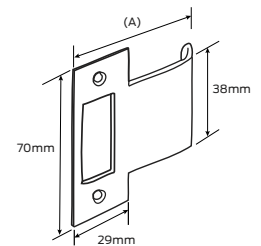

### DR13 Rebate kit for D Series

This kit adapts bolts and strikes for 13mm rebated door preparations  
**Finishes:** Chrome plate, polished brass, satin chrome plate

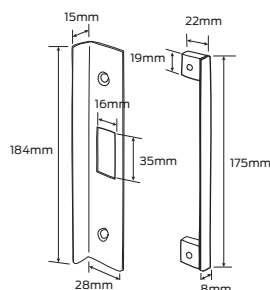

### Short lipped strike

Strikes for non-standard jambs  
**Finish:** Chrome plate, polished brass, satin chrome plate

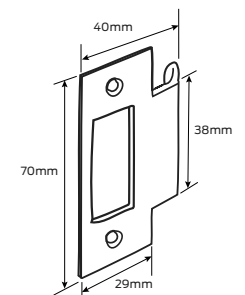



ALLEGION™

PIONEERING SAFETY™

We are  
Allegion

Briton ■ LCN ■ LEGGE ■ SCHLAGE ■ VON DUPRIN