



aquatherm – Next Generation of Maritime Pipes

Corrosion-resistant pipe systems made of polypropylene

For supply networks and ship operating systems



aquatherm

state of the pipe





SOLUTIONS

For many years, the global shipbuilding market has been growing steadily, experiencing simultaneously a process of profound changes. Large ships are now dominant in shipping due to a significant increase in traffic and tourism. This trend is accompanied by stricter environmental and pollution control standards as a result of expanding trade and the tourism sector.

aquatherm supports the maritime industry in solving emerging technical, operational and environmental problems by offering high-quality polypropylene piping for liquid media and compressed air.

Resistant to corrosion, wear and chemical attack, aquatherm piping systems are ideal for:

- **extreme high sea conditions**
- **providing excellent economic efficiency**
- **long life**

fusiolen® – for the benefit of our environment!

All aquatherm products are made of fusiolen® polypropylene. The environmentally friendly fusiolen® is recyclable and can be ground, melted and reutilised for various applications. There are no polluting substances neither in its processing nor in its disposal.

SELECTION OF OUR INTERNATIONAL MARITIME APPROVAL MARKS



ABS EUROPE LTD.

Salt water resistance:	100 years
Deep sea approved:	3000 m
Temperatur range:	-40 °C to +90 °C
Thermal conductivity:	0.15 W/mK

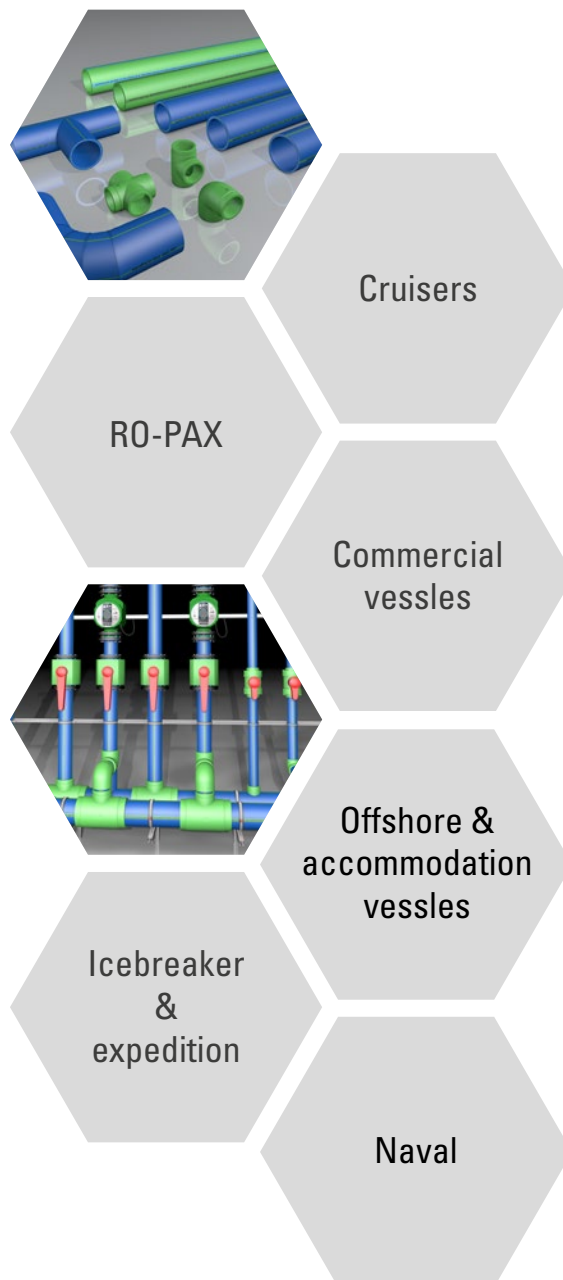

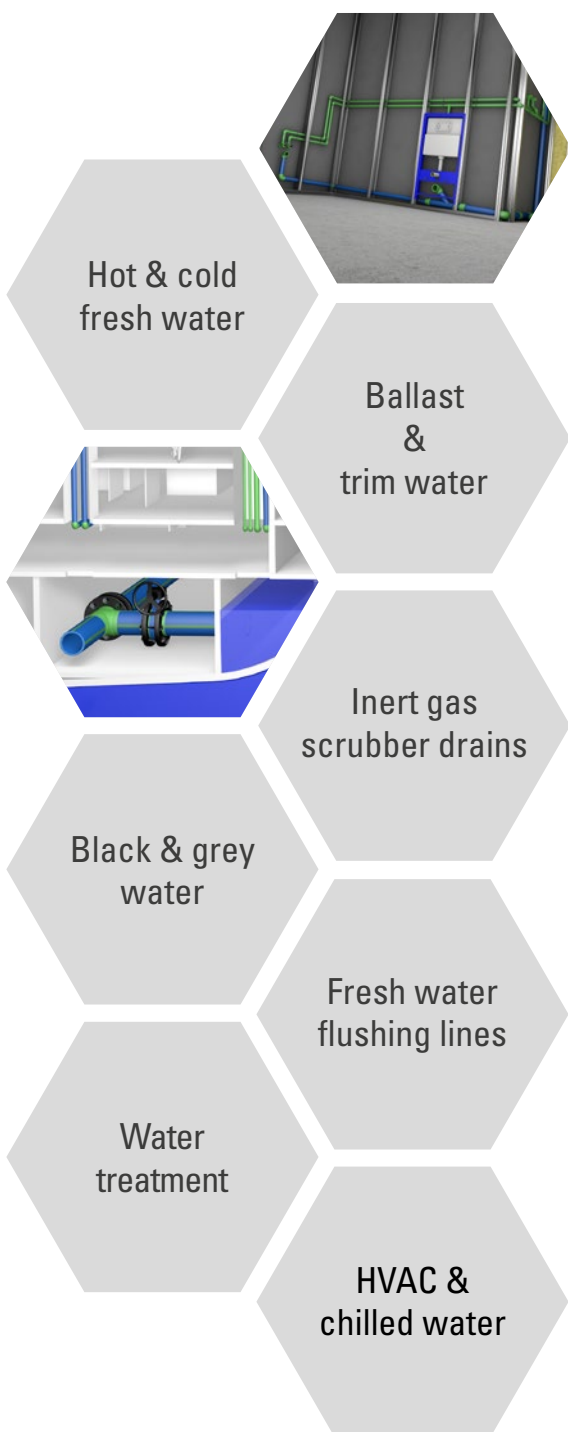

APPLICATIONS

Thanks to a wide range of superior products, integrated systems and additional technologies for the shipbuilding industry, aquatherm covers all major installations onboard the vessel: ballast and cooling systems, solutions for water treatment as well as hot and cold water distribution systems.

aquatherm polypropylene pipes provide various benefits such as:

- **light weight**
- **fast installation**
- **corrosion resistance**

Lower density and weight

aquatherm polypropylene pipes help you to save weight. While steel has a nominal weight of 7800 kg/m³ and GFK of 2000 kg/m³ our pipes feature only 980 kg/m³.

Iron-free is rust-free

Rust is an iron oxide formed by the redox reaction of iron and oxygen in the presence of water or air moisture. Several forms of rust are distinguishable both visually and by spectroscopy, and form under different circumstances. aquatherm polypropylene pipes are corrosion resistant and rust free.

aquatherm's solutions guarantee a long and cost-effective operation. For many years, customers around the world have been relying on professional support in the development of efficient, durable and cost-effective systems, benefiting from increased productivity through lower frequency of maintenance and docking, and lower overall operating costs.

JOINTING TECHNOLOGY

Butt welding & socket welding

High accuracy, very high bond strength and at the same time ease of use are convincing advantages that make this cost-effective and reliable technology ideal for large diameter pipes. aquatherm offers a wide range of processing machines from manual devices to CNC controlled welding machines while ensuring the highest flexibility of application and quality. The pipe and fitting become a single piece with no potential leak path.

Flange connection

While butt welding is done mostly at the workshop, flanges may be used for connection at site. This will save time and cost. Flanges can be delivered in PN 10 and on special demand also PN 16, all seawater resistant. Flange adapters are available as standard and for special butterfly valves on request. Gaskets are delivered in EPDM-quality.



HOT AND COLD FRESH WATER

According to the German "Drinking Water Ordinance" and many other international regulations of health organisations such as the WHO, the consumption or use of water should never pose a risk to human health. The chemical and microbiological composition of the water must be monitored by the health authorities, but also by the facility management to ensure high drinking water quality.

With our hygienic piping system aquatherm green pipe excellent drinking water quality can be permanently maintained. It is not only corrosion-resistant but physiologically and microbiologically safe, and adds no odours or taste to the water flowing through it. Its technical suitability and performance has been proven worldwide for decades. A variety of 450 different pipes and fittings with dimensions from 20 to 355 mm ensures safe and easy installation. Pre-fabricated pipe spools are also available.

aquatherm green pipe SDR 9 MF RP

- Structure of pipe:** MF = multilayer, with fibre reinforced
- Special feature of pipe:** RP (raised pressure)
- Material:** fusiolen PP-RP
- Pipe series:** SDR 9/S 4
- Standards:** SKZ HR 3.28, ASTM F 2389, ISO 21003
SKZ A632/A644
- Colour:** green with 4 dark green stripes
- Form supplied:** ø 32–125 mm straight lengths 4 m
ø 160–355 mm straight lengths 5.8 m

Mechanically stabilized through a fibre mix integrated in the middle layer of the fusiolen® PP-RP.

SDR	Art. no.	Dimension d [mm]	Wall thickness s [mm]
9	370712	32	3.6
	370714	40	4.5
	370716	50	5.6
	370718	63	7.1
	370720	75	8.4
	370722	90	10.1
	370724	110	12.3
	370726	125	14.0
	370730	160	17.9
	370734	200	22.4
	370738	250	27.9
	370742	315	35.2
	370744	355	39.7

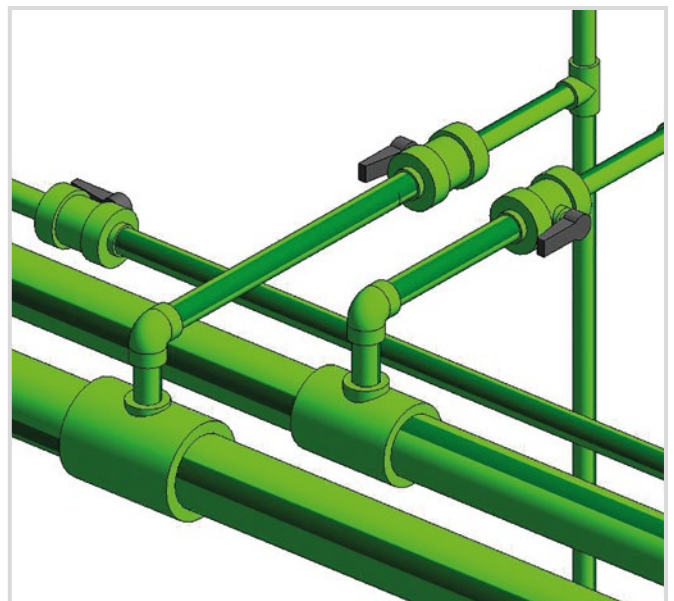

Hydraulic pipe design aquatherm green pipe

aquatherm green pipe SDR 7.4 MF

- Structure of pipe:** MF = multilayer, with fibre reinforced
- Material:** fusiolen PP-R
- Pipe series:** SDR 7.4/S 3.2
- Standards:** SKZ HR 3.28, ASTM F 2389,
CSA B 137.11, ISO 21003, SKZ A314/616
- Colour:** green with 4 dark green stripes
- Form supplied:** straight lengths 4 m

Mechanically stabilized through a fibre mix integrated in the middle layer of the fusiolen® PP-R.

SDR	Art. no.	Dimension d [mm]	Wall thickness s [mm]
7.4	70708	20	2.8
	70710	25	3.5

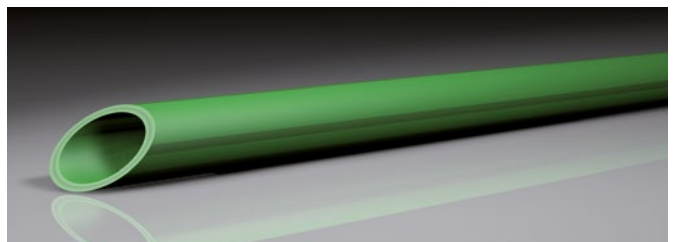



HVAC AND CHILLED WATER

Onboard ships and offshore structures the right HVAC system is most important for a well controlled climate and the comfort of passengers and crew. The system needs to be planned and designed in the best possible way considering the type of vessels, health, safety, and environmental aspects to ensure safe and efficient operation. In case of chilled water units and absorption chillers, there is usually a long-distance pipe network connecting the cooling plant with the air handling units in the cabins/workspaces or with the electric equipment cooling units.

The typical medium for energy transport is water or a water/glycole mixture, mainly to avoid large refrigerant pipe systems. In some applications, seawater can be used as cost free cooling medium. For these challenging applications it is very important to select the right pipe system.

aquatherm blue pipe, available in dimensions from 20 to 630 mm, is the best choice due to its chemical resistance allowing a service life up to 100 years in sustainable operation conditions. Compared to metal or GFR pipes, aquatherm polypropylene pipes feature lower weight which can help to reduce fuel costs.

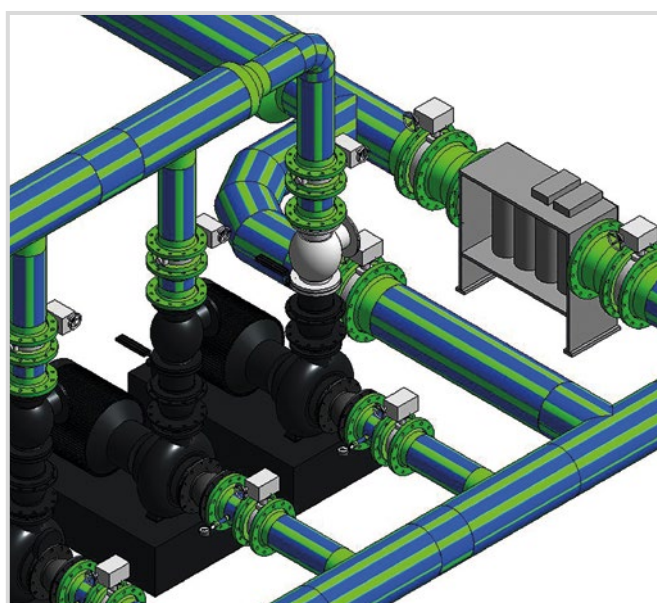

Hydraulic pipe design aquatherm blue pipe

aquatherm blue pipe SDR 7.4 / 11 MF

Structure of pipe: MF = multilayer, with fibre reinforced

Material: fusiolen PP-R

Pipe series: SDR 7.4/S 3.2 & SDR11 / S 5

Standards: SKZ HR 3.28, ASTM F 2389, CSA B 137.11, ISO 21003

Colour: blue with 4 wider green stripes

Form supplied: ø 20–125 mm straight lengths 4 m
ø 160–450 mm straight lengths 5.8 m

Mechanically stabilized through a fibre mix integrated in the middle layer of the fusiolen® PP-R.

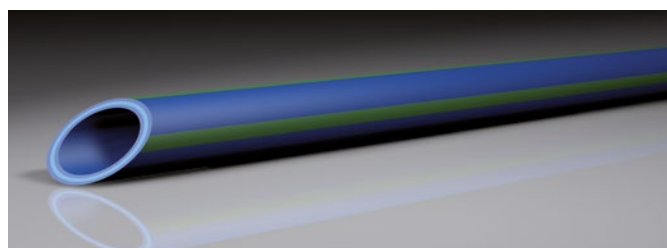

SDR	Art. no.	Dimension d [mm]	Wall thickness s [mm]
7.4	2070708	20	2.8
	2070710	25	3.5
	2070712	32	4.4
11	2070112	32	2.9
	2070114	40	3.7
	2070116	50	4.6
	2070118	63	5.8
	2070120	75	6.8
	2070122	90	8.2
	2070124	110	10.0
	2070126	125	11.4
	2070130	160	14.6
	2070134	200	18.2
	2070138	250	22.7
	2070142	315	28.6
	2070144	355	32.2
	2070146	400	36.3
	2070148	450	40.9



INERT GAS SCRUBBER DRAINS

Scrubber

Wet scrubbers are used in many industrial processes to remove potentially harmful and polluting gas emissions. These gases form as a result of combustion in utility and industrial process plants. By-products and waste gases that can be removed during scrubbing can include hydrochloric acid (HCl), hydrogen sulfide (H₂S), chlorine (Cl₂), and sulfur dioxide (SO₂). aquatherm blue pipe provides the right solution for wet scrubber drains as it has a high chemical resistance.

Sulphur cap

From 1st January 2020, shipping will see huge changes in its use of fuel, as the Global Sulphur Cap comes into force, requiring the use of compliant fuel or abatement technologies. The new regulation will increase the demand for exhaust gas cleaning systems. aquatherm is prepared to take this challenge together with you.

aquatherm blue pipe SDR 17.6 MF

- Structure of pipe:** MF = multilayer, with fibre reinforced
- Material:** fusiolen PP-R
- Pipe series:** SDR 17.6 / S 8.3
- Standards:** SKZ HR 3.28, ASTM F 2389, CSA B 137.11, ISO 21003
- Colour:** blue with 4 wider green stripes
- Form supplied:** ø 20–125 mm straight lengths 4 m
ø 160–630 mm straight lengths 5.8 m

Mechanically stabilized through a fibre mix integrated in the middle layer of the fusiolen® PP-R.

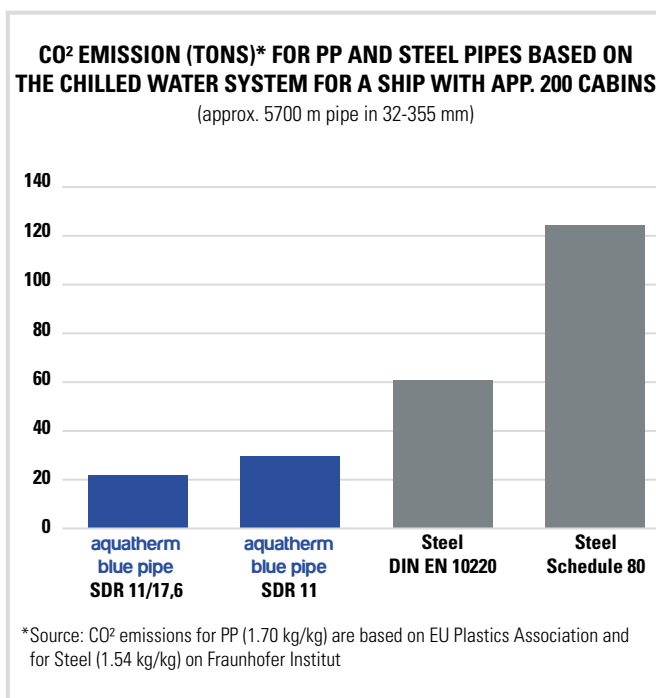
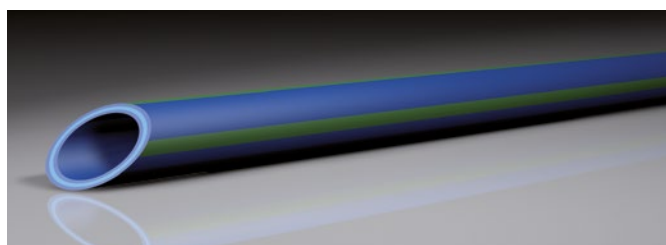

SDR	Art. no.	Dimension d [mm]	Wall thickness s [mm]
17.6	2570126	125	7.1
	2570130	160	9.1
	2570134	200	11.4
	2570138	250	14.2
	2570142	315	17.9
	2570144	355	20.1
	2570146	400	22.7
	2570148	450	25.5
	2570150	500	28.4
	2570154	630	35.7



BALLAST AND WATER TREATMENT

To guarantee safe operating conditions throughout the voyage, it is necessary to determine and constantly maintain certain parameters relating to lateral stability, roll, trim, maneuverability and stresses in the hull of the vessel. Ballast water systems are used to provide the required weight in strategic locations inside the ship. In order to maintain the optimal ballasting of the vessel afloat and during loading/unloading, the ports install ballasting and ballast tank systems for the accurate pumping and transport of ballast water. aquatherm polypropylene pipes provide:

- **high corrosion resistance**
- **maximum safety**
- **high reliability and flexibility**
- **low friction value**

in the management of ballast water pumping. In combination with fast, reliable and safe welding technologies, these lightweight systems become a convincing argument also for fuel savings.

In order to prevent serious environmental consequences or impact on human health, ships must clean ballast water from a variety of marine organisms. Reliable, durable aquatherm solutions support the shipbuilding industry at all stages of the purification process from pretreatment, filtration or coagulation to disinfection by chemical or physical means and fulfill all international regulations.

CUSTOMISED PREFABRICATION

Due to the diversity of today's application in the maritime engineering sector, there is hardly any chance of being able to cover the distribution of fluid media using standardized or modular manifold design. Every construction project has its own individual requirements.

aquatherm supports its customers with prefabricated manifolds customized on medium type, application, architectural circumstances as well as regulations and laws. Benefit from:

- **tested quality with a 10 years warranty**
- **highest accuracy due to detailed planning**
- **no delays due to missing parts**
- **low tooling costs**

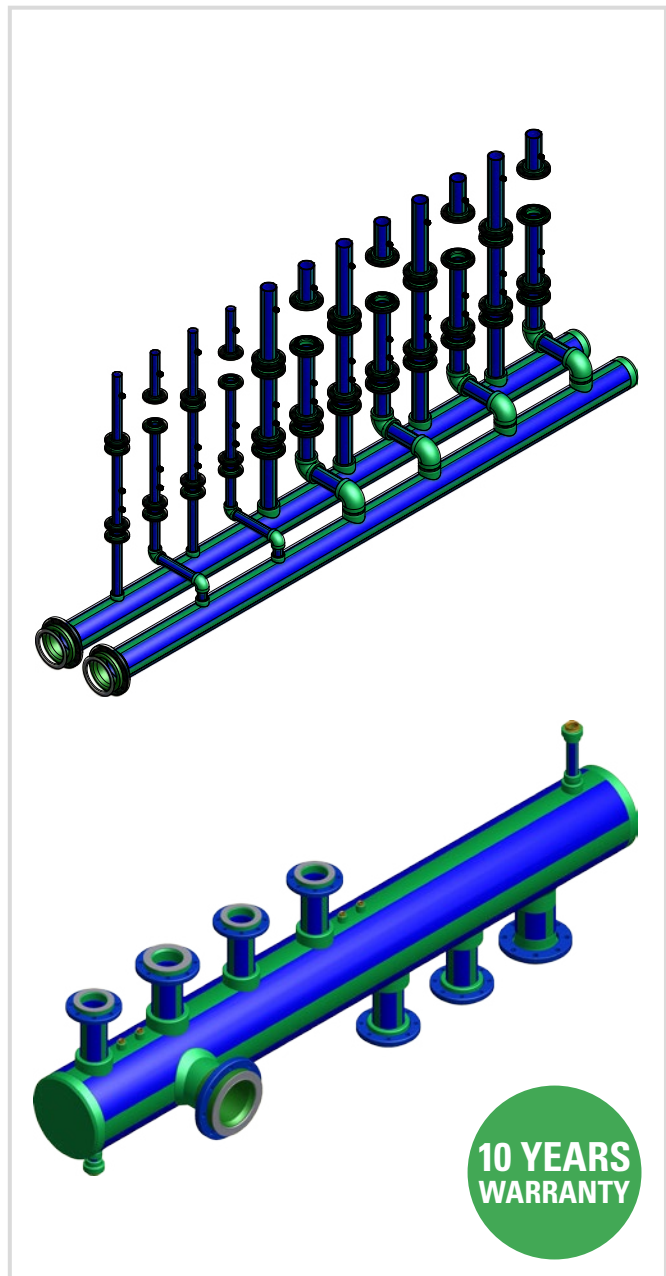

**10 YEARS
WARRANTY**



INTERNATIONAL MARITIME REFERENCES

More than 5000 vessels are equipped with aquatherm pipes worldwide

Ship	IMO Hull No.	Type
Saipam FDS	1861	Crane vessels
Heerema New	3402	Crane vessels
Costa Victoria	9109030	Cruise
Carnival Conquest	9198355	Cruise
Caribbean Prinzess	9215490	Cruise
AIDAvida	9221554	Cruise
AIDAaura	9221566	Cruise
Odfjell GVA 7500 Semi	3023	Drilling rig
GroupoR 7500 Semi	3026	Drilling rig
97K	1747	Drillship
PPM	1809	Drillship
Pride	1862	Drillship
Schahin	1869	Drillship
DPW Nr.1	2148	Drillship
Mecklenburg Vorpommern	9131797	Ferry
Ulysse	9142459	Ferry
Salambo 7	9142467	Ferry
Stena Britannica	9419175	Ferry
Tanit	9598579	Ferry
Allseas Platform	3401	Heavylift vessel
Thetris	F357	Naval
Absalom	L16	Naval
Danish Royal Yacht	5437661	Sailing yacht
White Peal - A	1012141	Sailing yacht
BBL5 FPSO	1763	Tanker

FURTHER INFORMATION:

For more information please contact us at **+49 2722 950 0**
or visit the download centre at our website **www.aquatherm.de**



Management
System
ISO 9001:2015
ISO 14001:2015
ISO 50001:2011
www.tuv.com
ID 0091005348

aquatherm GmbH

Biggen 5 | 57439 Attendorn | Germany

Tel.: +49 (0) 2722 950-0 | info@aquatherm.de | www.aquatherm.de