



JURALCO EDGETEC® DOUBLE DISC ANCHOR BALUSTRADE SYSTEM

ISSUE 7-24 v1

Juralco Edgetec® Double Disc Anchor Balustrade System

Juralco Aluminium Building Products Ltd designs and distributes specialist aluminium joinery systems through a national network of franchised fabricators and agents.

For more than 25 years we have been at the forefront of specialist aluminium door and window products suitable for New Zealand joinery and building methods. Our comprehensive product range includes security and insect screens, balustrades and gates, shutters and awnings, shower screens, wardrobe doors and organisers and internal doors.

The Juralco Edgetec® Double Disc Anchor Balustrade system is designed for Frameless Glass, from 12mm to 17.52mm, Faced fixed and for Residential or Commercial use. The system is extremely versatile and can be made in a range of configurations to suit most modern architectural requirements.

- Juralco Edgetec® Double Disc Anchor Balustrade System
- Glass Panels from 12mm Toughened Safety Glass to 17.52mm SentryGlas
- Discs spaced at horizontally 300mm or 400mm depending on Wind Zone
- Disc centres standard at 110mm.
- Simple installation. Allows horizontal and vertical glass adjustment.

- Tested to NZ standard NZS4203 and NZS1170
- Conforms to NZS4223.3.2016
- Top Interlinking Rail to conform to NZS4223.3.2016
- Balustrade options up to Very High, and Free Standing Pool Fence options up to Extra High Wind Zones



Edgetec Double Disc Satin Black, Square Trim with Top Interlinking Rail



Edgetec Double Disc SS, C/S screw fixings with Top Interlinking Rail

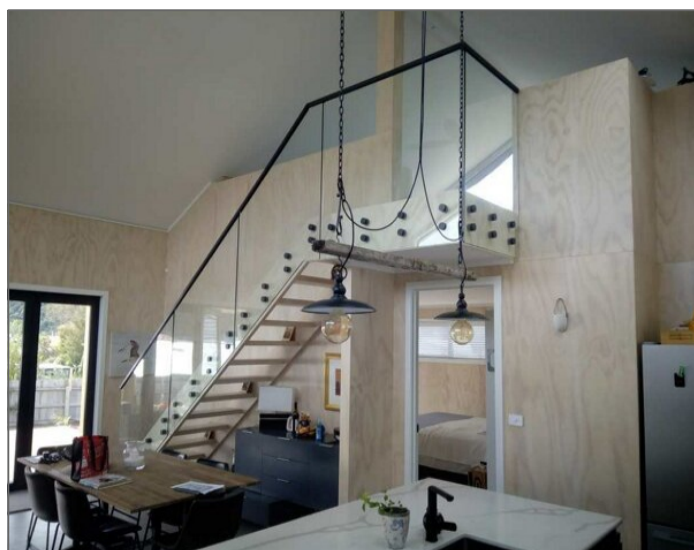

Edgetec Double Disc Satin Black, hidden fixings with Top Interlinking Rail



Edgetec Double Disc SS, C/S screw fixings with Top Interlinking Rail

All pages© Copyright Juralco Aluminium Building Products Ltd, 2024

Juralco Edgetec® Double Disc Anchor Balustrade System

Complies With AS/NZS 1170:2002, NZS 4223.3.2016, NZ Building Code B1, B2, F2, F4 and F9

Double Disc Balustrade is for Domestic and Residential Occupancy types A, A Other and C3 and for Commercial Occupancy Types B, E and C3 Occupancy Types as per AS/NZ 1170.1.2002. Not suitable for Commercial C1/C2, C5 and D applications

Code	Type of Occupancy for part of the building or structure	Specific Uses	Glass
A	Domestic and Residential activities	All areas within or serving exclusively one dwelling including stairs, landings etc, but excluding external balconies and edges of roofs. (see C3)	Residential, 12mm Toughened Glass, 15.2mm Laminated Safety Glass 13.52 Laminated SentryGlas
B, E	Offices and work areas not included elsewhere including storage areas.	Light access stairs and gangways not more than 600mm wide Fixed platforms, walkways, stairways and ladders for access Areas not susceptible to overcrowding in office and institutional buildings; also industrial and storage building.	Commercial, 15mm Toughened Glass, 17.2mm Laminated Safety Glass 17.52 Laminated SentryGlas
A Other, C3	Areas without obstacles for moving people and not susceptible to over crowding	Stairs, landings, external balconies, edges of roofs etc.	Residential or Commercial as detailed above

Note 1 All for 12mm or 15mm Toughened Glass, 15.2mm or 17.2mm Laminated Glass and 13.52mm or 17.52mm SentryGlas
All edges polished, all Holes to be smooth and chip and crack free

Note 2 Juralco Balustrade Systems building code compliance documentation requires all balustrade installations are to be completed in accordance with the requirements of our authorised installer certification.

Note 3 All Frameless glass balustrades, except for SentryGlas must have an Interlinking Rail to conform to NZS 4223.3.2016
Not Required for Swimming Pools

Note 4 The Dulux powder coating warranty period is conditional upon the Balustrade being maintained in accordance with the Dulux 'Care and Maintenance Instructions'. See Warnings concerning Coastal conditions.
Contact your balustrade installer for a copy of the Care and Maintenance procedure.

masterspec partner
Section 4852JB

Index

Heading	Pages	Description.	Use the Bookmarks List to jump to selected pages
Specifications	4	Juralco standard specification sheet and Powder coating recommendations	
Configurations	5 - 7	Shows typical Balustrade layouts for High, Very High and (Pool only) Extra High Wind Zones	
	8 - 9	Shows typical Stair Layouts and attach details	
General	10	Shows the Double Disc cross sections and all details	
Components	11	Shows all Components	
Mountings	12 - 17	Shows recommended Mounting details - to Timber (p12-13), Steel (p14-16) and Concrete (p17)	
Glass Panels. Top edge. Safety	18 - 27	Shows all Interlinking Rail options (5 x Total). Swivel connectors and End connections	
	28	Shows Glass stiffener brackets, Fixed and Adjustable angles	
End Brackets	29 - 30	Shows Interlinking Rail End bracket attachments to Posts and Structures	
Rail mounted to Glass Panel	31	Shows Interlinking Rail Side mounted to a Glass Panel and all End brackets	
Joiners and End Plates	32 - 34	Shows Interlinking and Handrail Joiners and End Plates	
Surface Care	35 - 37	Instructions for the care of Glass, Powder Coated and Stainless Steel surfaces	

Specifications for Juralco Edgetec® Double Disc Anchor Balustrade System

1. Scope

- This specification details the documents the Juralco Edgetec® Double Disc Anchor Balustrade System refers to in relation to the New Zealand Building Code, the manufacturer's documents, products used in the System, requirements in relation to fixing and surface finishing.

2. NZBC Compliance

- The Juralco Edgetec® Double Disc Anchor Balustrade System has been tested by Lautrec Technology Group Ltd to demonstrate compliance with the structural requirements of the New Zealand Building Code and AS/NZS 1170 : 2002 occupancy A, A Other and C3. Options for Low, Medium, High, Very High and Extra High Wind Zones for Balustrades connected to buildings meeting the scope of NZS3604. Options for Very High and Extra High Wind Zones for free standing Pool fences, not protecting a fall of 1.0m or more.
- The Structural Engineering design includes the requirements of B1 Structure, B2 Durability, F2 Hazardous material and F4 Safety from falling, all from the Building Code.
- Verification Method B1 / VM1, B2/AS1, F4 / AS1
- All glass used in the Juralco Edgetec® Double Disc Anchor Balustrade System must conform to AS/NZS 2208.
- Complies with NZS4223.3.2016

3. Manufacturer's Documents

- The Juralco Edgetec® Double Disc Anchor Balustrade System manual details all extrusions and components used for the fabrication and installation/fixing of the system.
- A Producer Statement 1(Design) is available.
Copies of the above documents are available from:
Juralco Aluminium Building Products Ltd
48 Bruce McLaren Rd, Henderson, Auckland
Phone 09 478 8018 Fax 09 478 7883 Email specify@juralco.co.nz
- Any deviation from the standard fabrication or installation/fixing must be accompanied by a site specific PS1 with site specific calculations and drawings. Enquires to Juralco PS1 for assistance.

4. Products

- Only extrusions, components and hardware supplied by or specified by JABP may be used in the Juralco Edgetec® Double Disc Anchor Balustrade System
- Aluminium extrusions, components and hardware – unless specified are manufactured to 6060 T5 specifications
- Stainless Steel components, hardware, fixings – all components to 316 grade
- Glass - all glass used in the Juralco Edgetec® Double Disc Anchor Balustrade System must conform to the specifications as listed in the Juralco Edgetec® Double Disc Anchor Balustrade System manual with each panel conforming to AS/NZS2208 as confirmed by the Safety Stamp detailing the manufacturer's description and licence number.

5. Surface Finishing

- Juralco Aluminium Building Products Ltd is a Dulux Registered Applicator site, registration number 2101.
JABP uses only Dulux branded powder coating materials
- Dulux Duralloy® powder coating systems are suitable for properties greater than 100m from high tide level
AAMA 2603 performance. Residential buildings, 3 levels max. Warranty 10 yrs
- Dulux Duralloy Plus® powder coating systems are suitable for properties greater than 10m from high tide level.
AAMA 2603 performance. Residential and Light commercial buildings, 3 levels max. Warranty 15 yrs
- Dulux Duratec® powder coating systems are suitable for properties greater than 10m from high tide level
AAMA2603 and 2604 performance. All Residential and Commercial buildings. Warranty 25 yrs

6. Installation and Fixing

- The Juralco Edgetec® Double Disc Anchor Balustrade System must only be installed in accordance with the Juralco Edgetec® Double Disc Anchor Balustrade System manual
- The Juralco Edgetec® Double Disc Anchor Balustrade System must only be fabricated/installed by a Juralco approved fabricator
- Upon completion of the installation the fabricator must supply the owner with a PS3 (Construction)

Important information - Powder Coating systems.

Powdercoat Systems The new standard Dulux powder coating system used by Juralco is Duralloy Plus®. Also Duralloy® and Duratec®. All as per specs above. Juralco Powder coated prices are for Duralloy Plus® and Duralloy® (same pricing). Duratec® prices on application.

Attachment to structures A PVC Tape or similar material spacer must be used to separate powder coated aluminium items from all concrete and steel structures. Failure to do so can lead to the chemicals in the structure affecting the powder coating, leading to corrosion.

Swimming Pools The chlorinated water in swimming pools can cause the deterioration of powder coated surfaces, leading to corrosion of the underlying surface. It is recommended that Powder coated surfaces be 1200mm min from a pool.

Care The Dulux powder coating warranty period is conditional upon the surface being maintained in accordance with the Dulux 'Care and Maintenance Instructions'. Download from Dulux or refer to the back page of this manual.

Juralco Edgetec® Double Disc Anchor Balustrade System Typical Layouts

Double Disc + Interlinking Rail

Glass must have a minimum strength of 100Mpa
All edges polished
All Holes to be smooth and chip and crackfree

Disc spacings
Min - 2 x Disc pairs
Max - 5 x Disc pairs

Residential & Domestic only
Occupancy types A, A Other and C3
All for 12mm Toughened Glass
or 15.2mm Laminated Glass
or 13.52mm SentryGlas

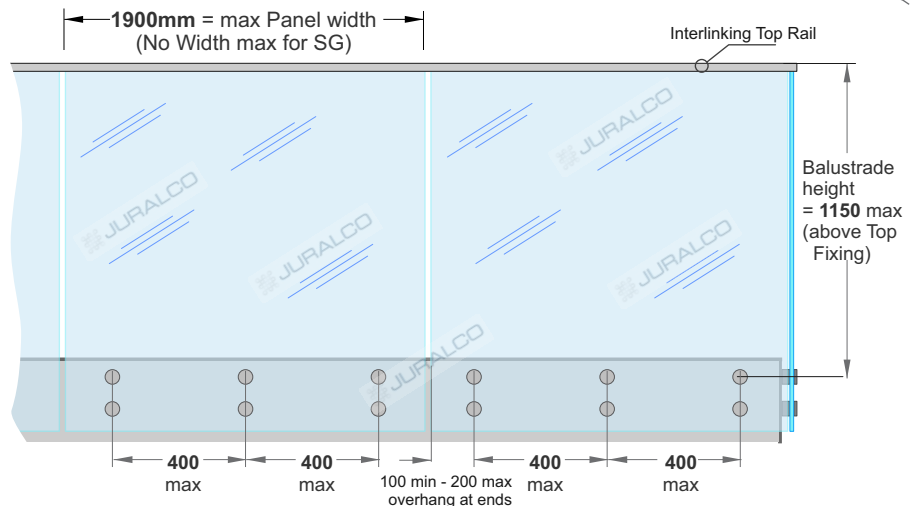

Exceeds the wind loading for all Wind Zones up to **and including Very High Wind Zone** as set out in NZS 3604:2011

Refer to the Interlinking Top Rail page for conformance to NZS 4223.3.2016.
- Not required for SentryGlas

Double Disc + Stiffener Bracket

Glass must have a minimum strength of 100Mpa
All edges polished
All Holes to be smooth and chip and crackfree

Disc spacings
Min - 2 x Disc pairs
Max - 5 x Disc pairs

Residential & Domestic only
Occupancy types A, A Other and C3
All for 15.2mm Laminated Glass
or 13.52mm SentryGlas

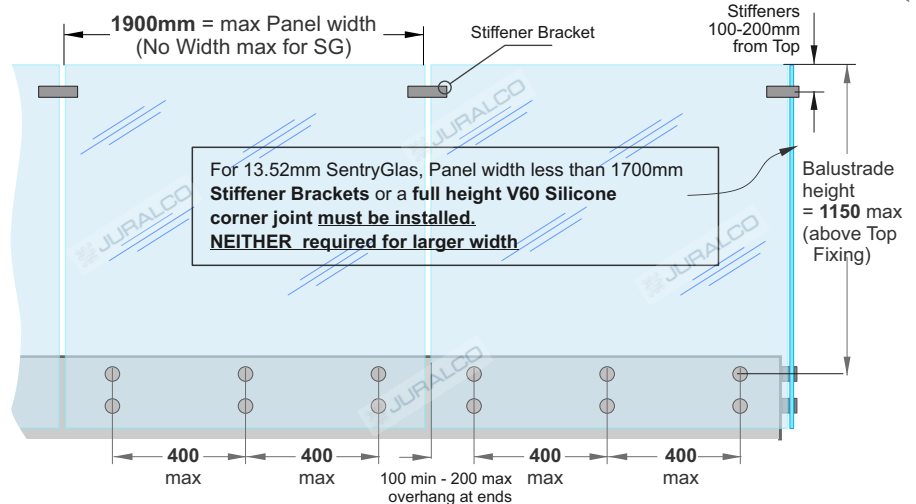

Exceeds the wind loading for all Wind Zones up to **and including Very High Wind Zone** as set out in NZS 3604:2011

Interlinking Top Rail not required

Double Disc Pool Fencing

POOL FENCING only

Glass must have a minimum strength of 100Mpa
All edges polished
All Holes to be smooth and chip and crackfree

Disc spacings
Min - 2 x Disc pairs
Max - 5 x Disc pairs

Applies to Swimming Pools as of Jan 2017, complies with the Building Code clause F9 and section 162C of the Building Act.

Applies to Pool Fences not protecting a fall of 1.0m or more

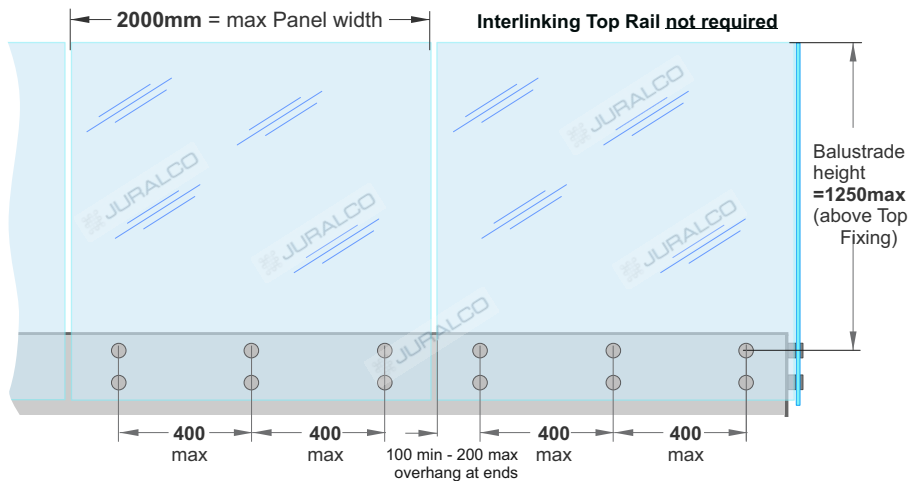

12mm Toughened, 15.2mm Laminated
Up to and including Very High Wind Zone.

15mm Toughened, 17.2mm Laminated
Up to and including Extra High Wind Zone

Juralco Edgetec® Double Disc Anchor Balustrade System Typical Layouts

Double Disc + Interlinking Rail

Glass must have a minimum strength of 100Mpa
All edges polished
All Holes to be smooth and chip and crackfree
Disc spacings
Min - 2 x Disc pairs
Max - 5 x Disc pairs

Commercial only
Occupancy types B, E and C3
All for 15mm Toughened Glass
or 17.2mm Laminated Glass
or 17.52mm SentryGlas

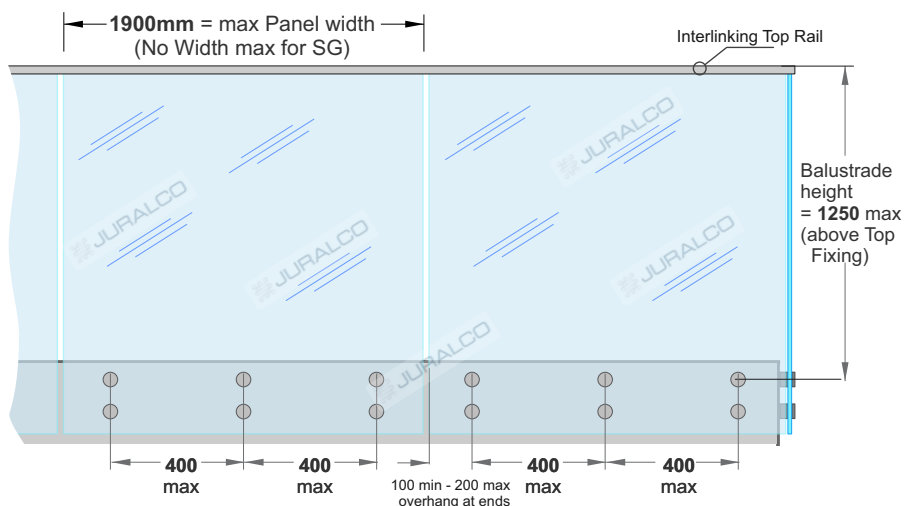

Exceeds the wind loading for all Wind Zones up to **and including Extra High Wind Zone** as set out in NZS 3604:2011
Refer to the Interlinking Top Rail page for conformance to NZS 4223.3.2016.
- Not required for SentryGlas

Double Disc + Stiffener Bracket

Glass must have a minimum strength of 100Mpa
All edges polished
All Holes to be smooth and chip and crackfree

Disc spacings
Min - 2 x Disc pairs
Max - 5 x Disc pairs

Commercial only
Occupancy types B, E and C3
All for 17.2mm Laminated Glass
or 17.52mm SentryGlas

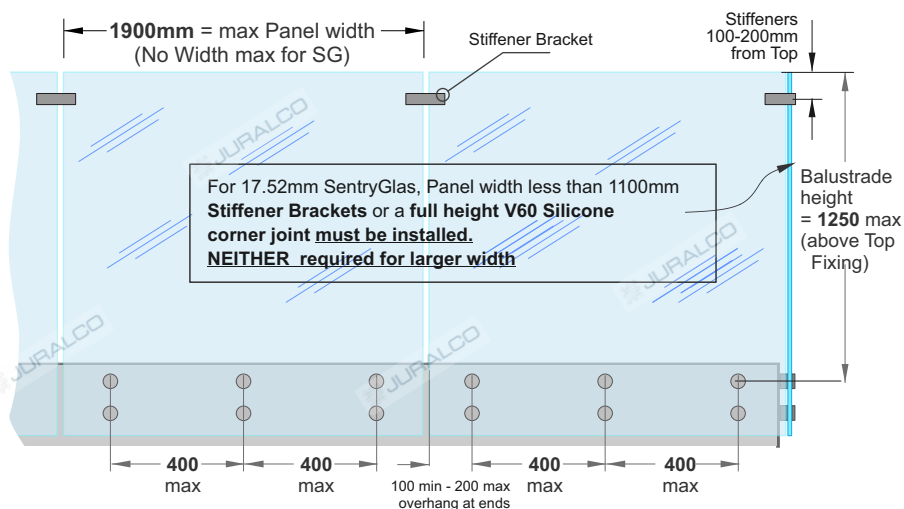

Exceeds the wind loading for all Wind Zones up to **and including Extra High Wind Zone** as set out in NZS 3604:2011
Interlinking Top Rail not required

Glass Types Specifications

Laminated Safety Glass. Glass Layers and Thickness Orientation

Glass Thickness (mm)	Inner Layer of Glass thickness (mm) Deckside	Interlayer thickness(mm) and Type	Outer Layer Glass thickness (mm)
15.2	8	1.2EVA	6
17.2	8	1.2EVA	8

SentryGlas® Glass Layers and Thickness Orientation

Glass Thickness (mm)	Inner Layer of Glass thickness (mm)	Interlayer thickness(mm) and Type	Outer Layer Glass thickness (mm)
13.52	6	1.52 SentryGlas®	6
17.52	8	1.52 SentryGlas®	8

Juralco Edgetec® Double Disc Anchor Balustrade System - Typical Stair Layout

Double Disc Balustrade

Typical Stair 300mm tread, 180mm step.
Screw fixings into Single or Double Joists/Stiffeners, Concrete or Steel

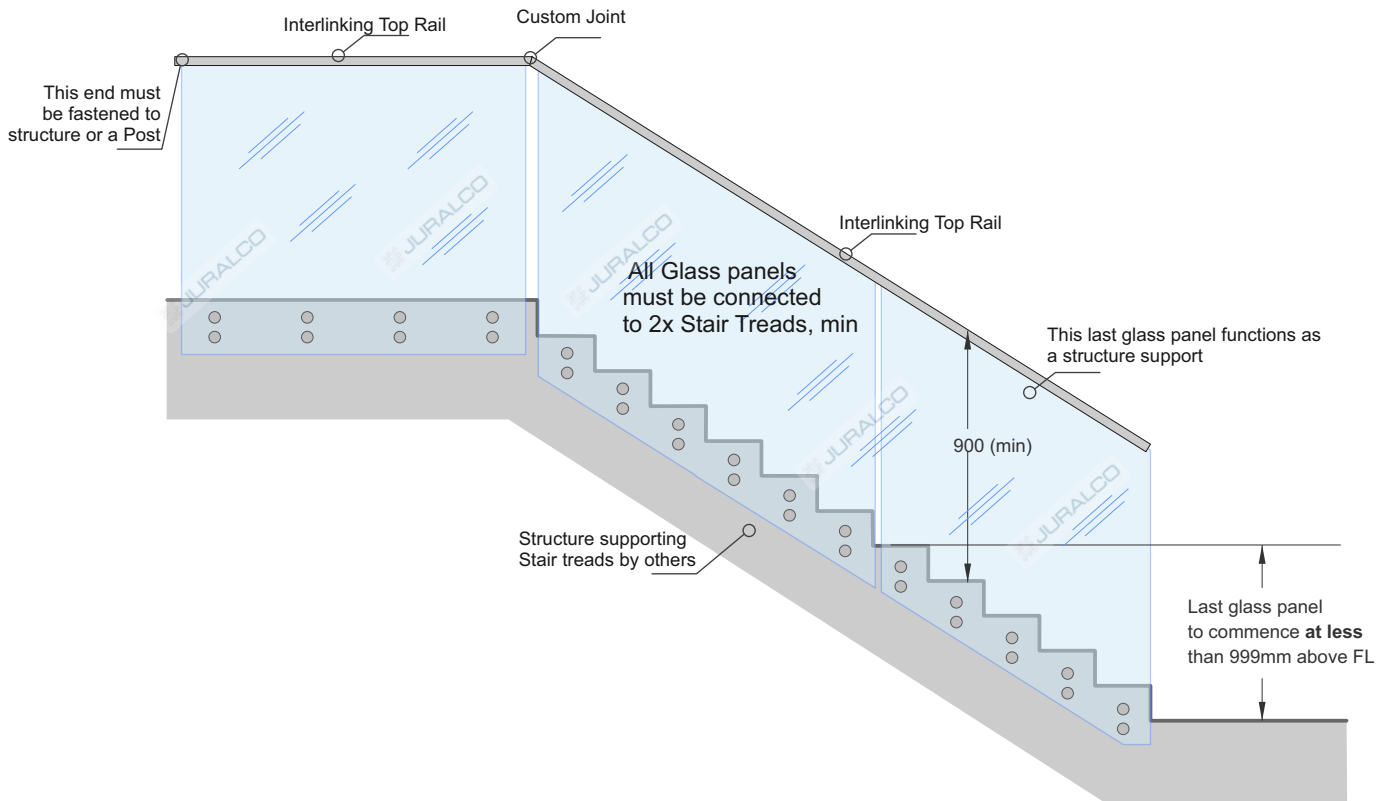

Double Disc Balustrade Stair Stringer Detail

C/S Fastener shown, Hidden fixing available

- Stair structure to be designed by others to resist Balustrade actions as per NZS1170.1 Table 3.3

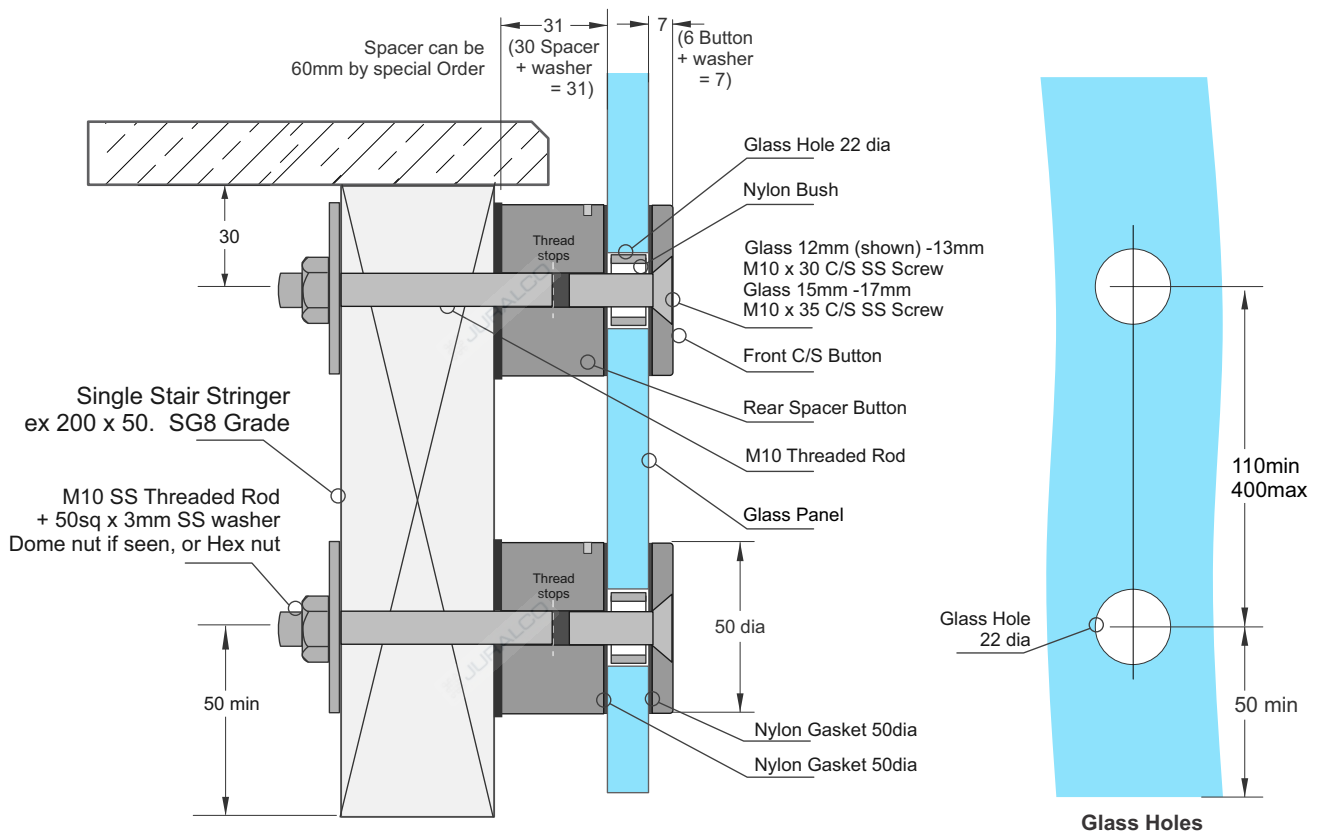

Assembly - must use Loctite on both threads.

Juralco Edgetec® Double Disc Anchor Balustrade System - Typical Stair Layout

Double Disc Balustrade

Typical Stair 300mm tread, 180mm step.
 Level portion - Screw fixings into Single or Double Joists/Stiffeners, Concrete or Steel
 Stair - Timber for Stairs, Laminated Veneer lumber, 300 x 75mm min. M10 Lagscrews + SIKA Supergrip30

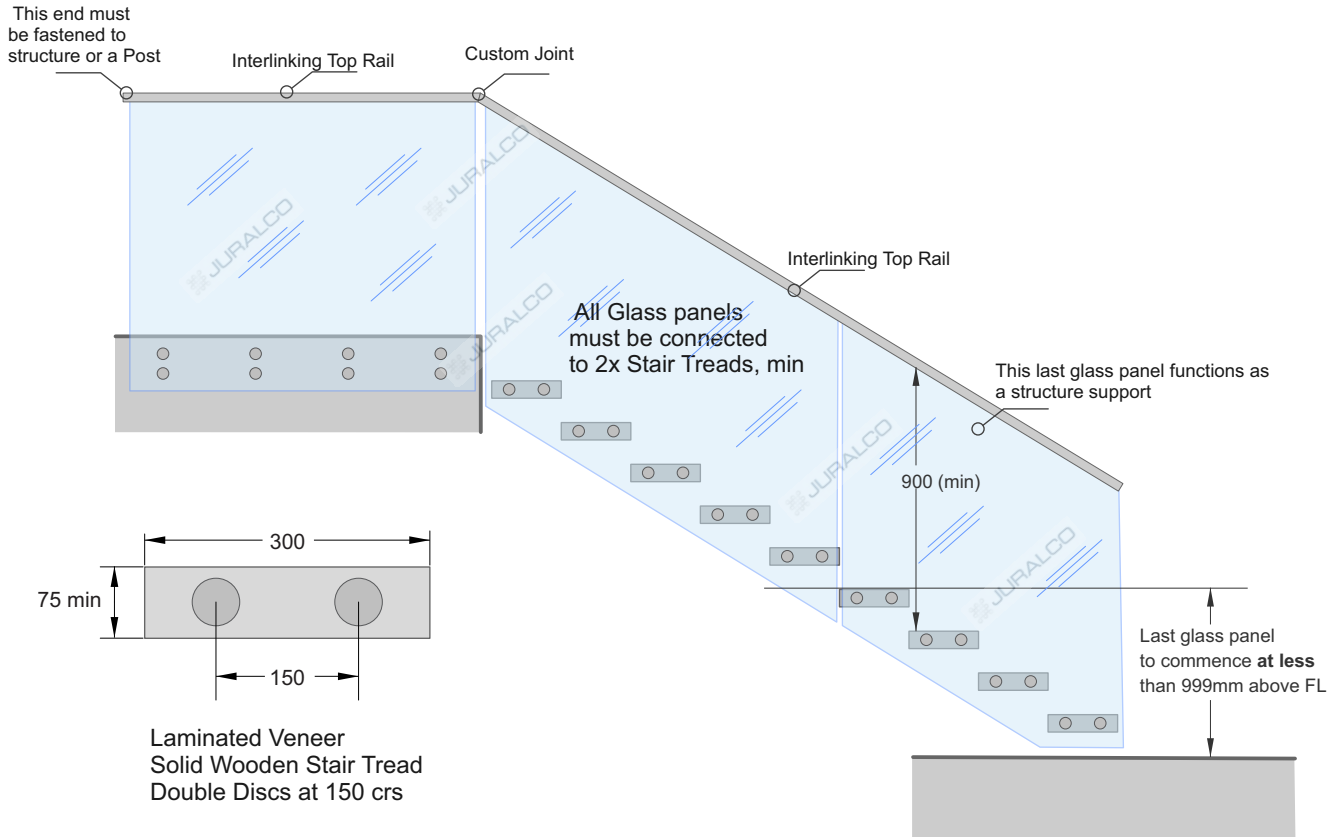

Double Disc Balustrade Stair Tread Detail

C/S Fastener shown, Hidden fixing available

Stair structure to be designed by others to resist Balustrade actions as per NZS1170.1 Table 3.3

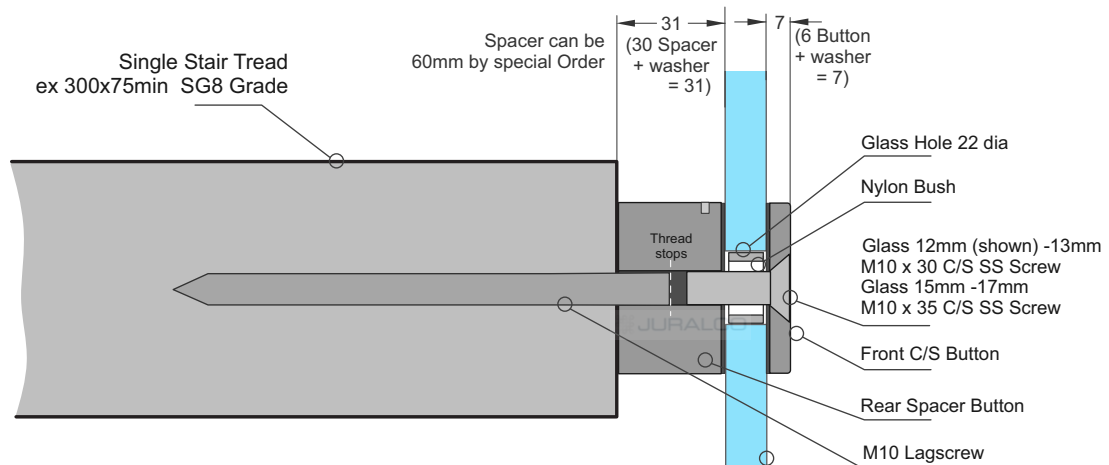

Important Notes:

- 1 - A Project engineer must ensure the structure can support the appropriate loads
- 2 - Pre drill holes 6mm dia for Lagscrew .
If End Grain ensure there is no Splitting
- 3 - Stair Timber, Laminated Veneer
- 4 - Lagscrew 160mm min screw engagement into Tread
- 5 - Bond all Lagscrews with SIKA Supergrip30 to full depth
- 6 - All fixings must be Stainless Steel

M10 SS Lagscrew

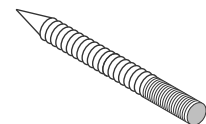

Juralco Edgetec® Double Disc Anchor Balustrade System - Typical Fixings

Countersunk Screw Double Disc

Important Notes:

- The Rear Spacer Button is threaded to halfway from both sides. ie max engagement is 15mm
- **Assembly** - must use Loctite on both threads. Max Lagscrew proud of timber = 14mm

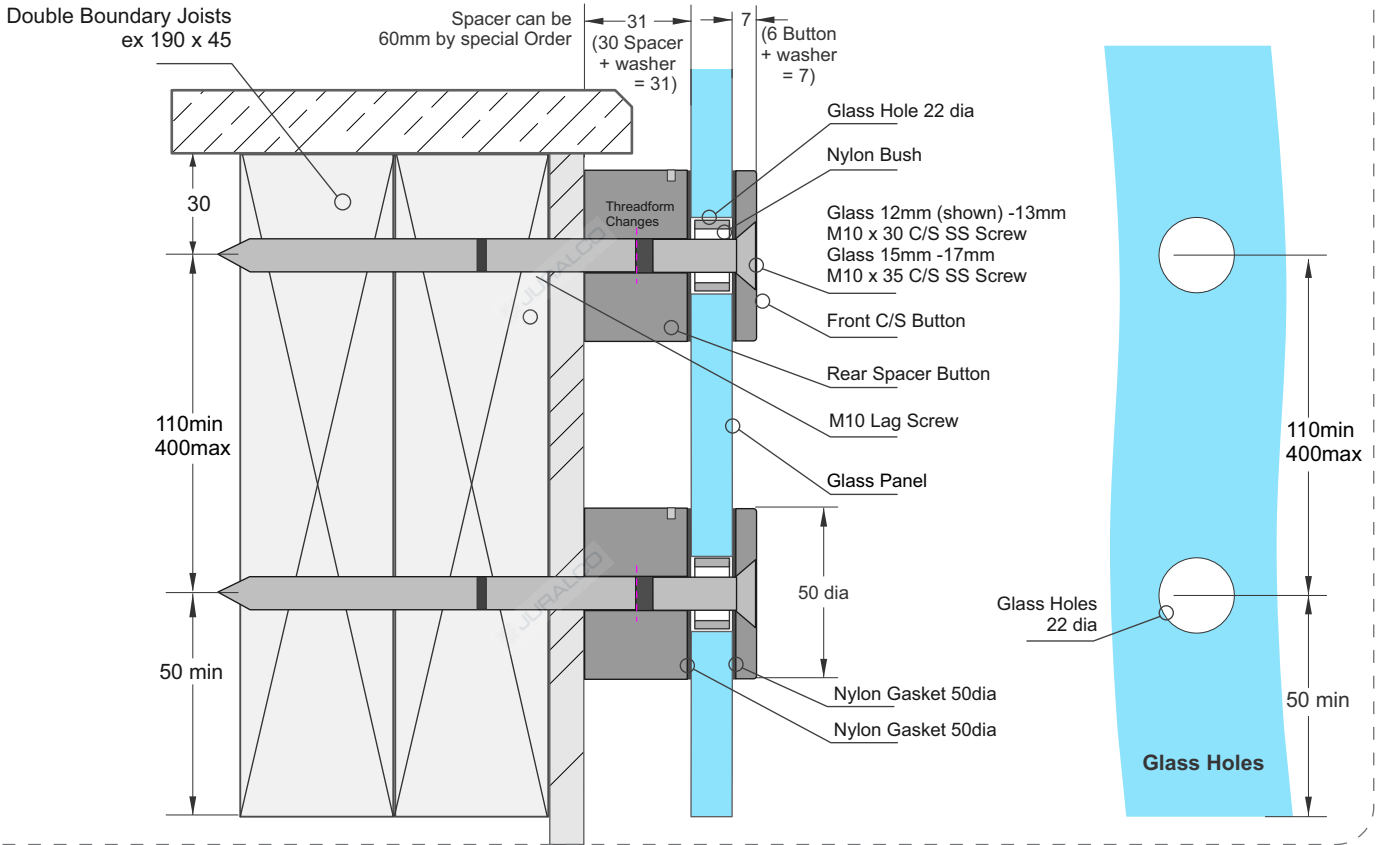

Hidden Double Disc

Important Notes:

- The Rear Spacer Button is threaded to halfway from both sides. ie max engagement is 15mm
- **Assembly** - must use Loctite on both threads. Max Lagscrew proud of timber = 14mm

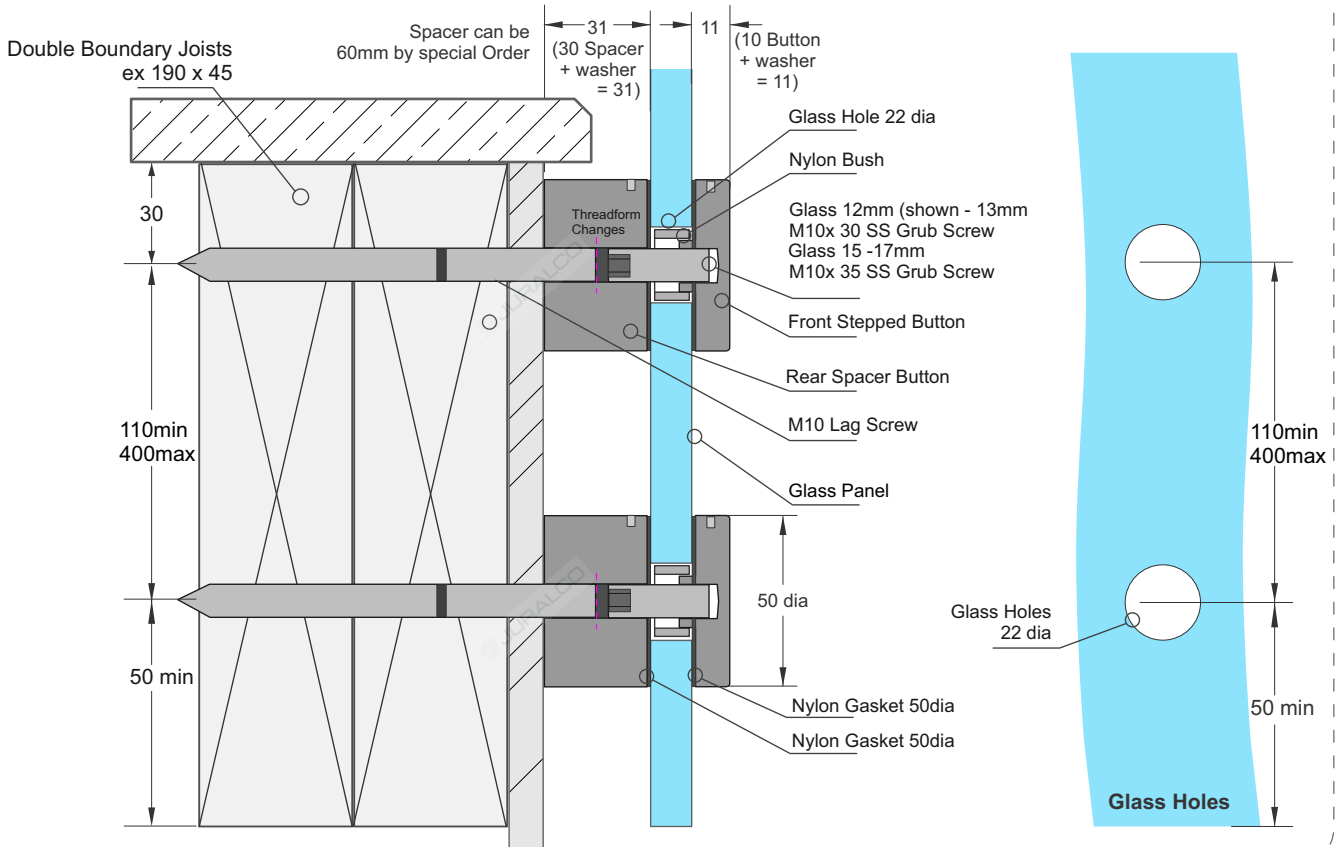

Juralco Edgetec® Double Disc Anchor Balustrade System - Components

Double Disc Countersunk Screw Fix

Countersunk screw fixing
316SS Only

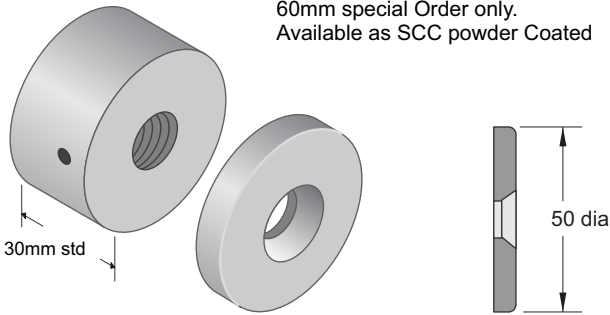

Double Disc, M10 countersink screw and Nylon gaskets supplied as a kit

Polished finish 316 SS
JETPS50/S30/PSS
Satin finish 316 SS
JETPS50/S30/SSS
SS Spacer 30mm Std,
60mm special Order only.
Available as SCC powder Coated

Double Disc Hidden Screw Fix

Hidden fixing
316SS or Aluminium



Double Disc, M10 grub screw and Nylon gaskets supplied as a kit

Polished finish 316 SS
JET50/T30/Body/PSS
Satin finish 316 SS
JET50/T30/Body/SSS
Powder coated Aluminium
JET50/T30/Body/SCC
SS Spacer 30mm Std,
60mm special Order only.
Available as SCC powder Coated

Double Disc Hidden Screw Fix, Adjustable

Adjustable Hidden fixing
Aluminium only

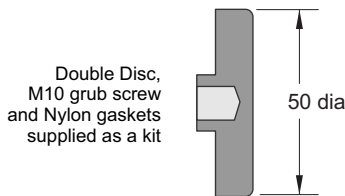

Double Disc,
M10 grub screw
and Nylon gaskets
supplied as a kit

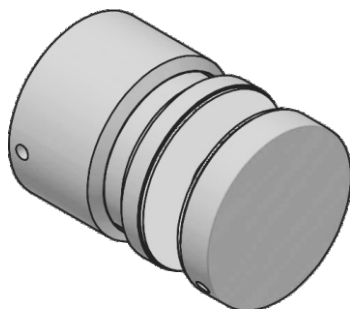

Powder coated Aluminium
JET50/AT45/SCC
Glass 12mm to 17.52mm glass
M10 mounting with lag screw
or threaded rod

Do not extend the adjustable mounting
beyond the 10mm indentation ring.
This should not be visible.

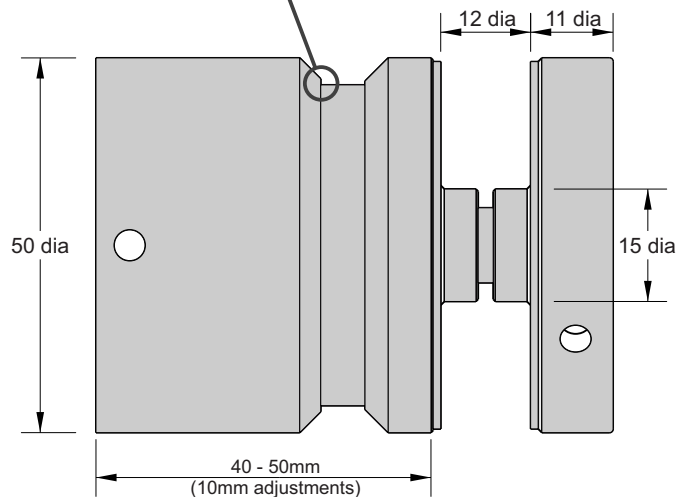

Installation Notes for the Adjustable Double Discs - JET50/AT45/SCC

1. Fix the outer bodies to the structure.
2. Thread the inner body all the way in the outer body to 40mm.
Do not extend the adjustable mounting beyond the 10mm indentation ring. This should not be visible.
Leave the inner body slightly loose to avoid the threads binding up. At the same time put the glass mount bush on the inner body.
3. Wind the bottom side inner bodies on the either end of the panel to the desired offset presetting them to 45mm allows for adjustment in both directions if glass needs leveling.
4. Position the panel of glass over the inner bodies and put the mounting caps on the 2 preset discs.
Tighten the mounting caps so the glass sits steady in the adjustable discs.
5. Check the level of the glass.
6. Tension the remaining inner bodies against the glass. This is done by using the Allen key in the centre of the inner body, which is accessed through the cutout in the glass. Doing this stops the inner bodies spinning with the mounting cap when they are installed. Adjustments can be made here to ensure the glass is level.
7. Add the remaining mounting caps, and do a final tighten of all the mounting caps.

Juralco Edgetec® Double Disc Anchor Balustrade System - Components

Double Disc Square Cover Kit JET50/SCK

Aluminium Sq cover as SCC only
Use Silicone to attach Rear Trim and Front Cover in place.
Rear Trim 30mm deep only

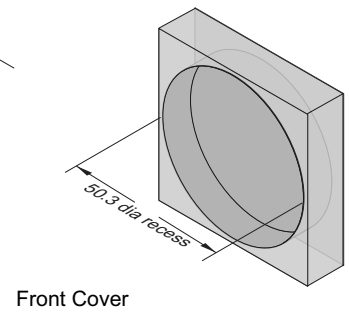
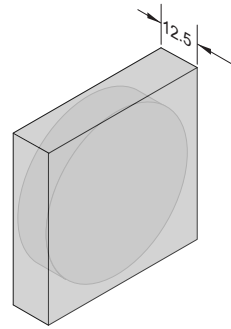
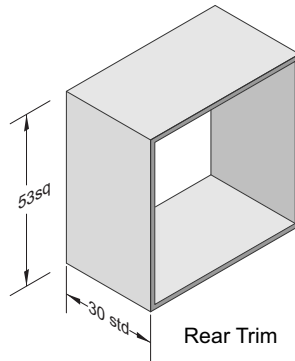

M10 SS Lagscrew

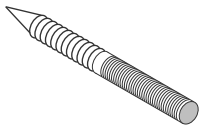

M10 SS Threaded Rod

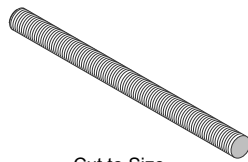

SS Pin Spanner JETS/50/Tool

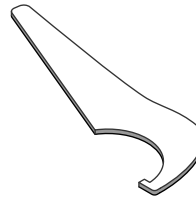

Rhodorsil V60 Clear Silicone H/RTV419098

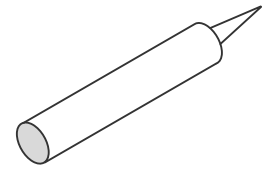

M10 C/S SS Machine Screw

Supplied as part of JET50/S/T30 kit



M10x25 for 12-13mm glass
M10x30 for 15-17mm glass

M10 SS Grub Screw

Supplied as part of JET50/S/T30 kit



M10x30 for 12-13mm glass
M10x35 for 15-17mm glass

Edgetec Nylon Bush JET/JH165 BUSH

Supplied as part of Double Disc kits



M10 SS Hex Nut JET/HEXNUT/M10SS



SIKA Supergrip JECSUPERGRIP30

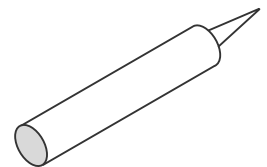

Hidden Screw Fix Cap

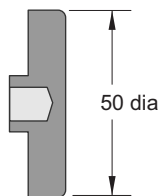

Available in SSS, PSS and SCC

JET50/T/10CAP/SSS
JET50/T/10CAP/PSS
JET50/T/10CAP/SCC

M10 SS Spacer JET50/6/SPACER/PSS



50dia x 6 Polished SS

M10 SS Washer JETSQWSH/50x50x3

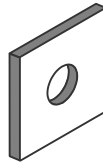

50sq x 3

M10 SS Washer JET/WASH/10x21



21dia x 2.5

M10 Nylon Gasket JET50/NG10



50dia x 10mm hole 1.1mm Black

M10 Nylon Washer JET/50NB20



50dia x 0.8 LDPE Internal only

M10 SS Spacer JET50/6/SPACER/SS



50dia x 6 Satin SS

M10 EPDM Spacer Washer JVB126



38dia x 3.0

M10 Nylon Gasket JET50/NG13



50dia x 13mm hole 1.1mm Black JET50/NG13

Juralco Edgetec® Double Disc Anchor Balustrade System
Typical Fixing - Residential, Commercial or Pool
Complies with NZS3604:2011 - Double Boundary Joists

Typical FACE Fix to Timber - M10 SS Lagscrews

Up to and including Very High Wind Zones Residential. Occupancy A, A Other and C3			Up to and including Extra High Wind Zones Commercial. Occupancy B, E and C3		
Glass Thickness, Type	Balustrade Height (max)	Disc Horiz Spacing (max)	Glass Thickness, Type	Balustrade Height (max)	Disc Horiz Spacing (max)
12 T	1150	400	15 T	1250	400
15.2L			17.2L		
13.52SG			17.52SG		
Occupancy A, A Other, B, E and C3. 0.75kN/m					

Up to and including High Wind Zone Pool Fence only			Up to and including Extra High Wind Zone Pool Fence only		
Glass Thickness, Type	Fence Height (max)	Disc Horiz Spacing (max)	Glass Thickness, Type	Fence Height (max)	Disc Horiz Spacing (max)
12T, 15.2L	1250	400	15T, 17.2L	1250	400

Applies to Pool Fences not protecting a fall of 1.0m or more

General Notes:

- 1 - Glass thickness mm
Glass type T= Toughened, L = Laminated
SG = SentryGlas
- 2 - All measurements mm
- 3 - Balustrade Height, above Top Fixing Point
- 4 - Refer to Elevations for Min/Max Panel widths

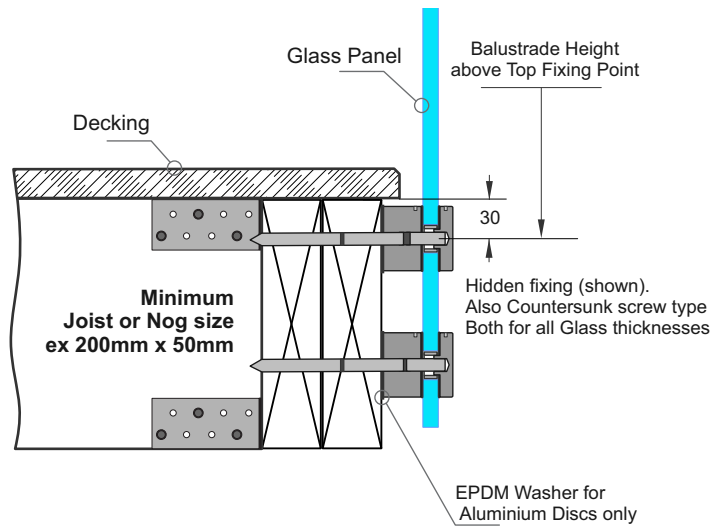

Important Installation notes:

- 1 - The Project Engineer must ensure the structure can support the appropriate loads
- 2 - Substructure shown indicatively only.
Timber SG8 minimum strength
- 3 - Lagscrews 90mm engagement into joists
All Lagscrews pre drill 6mm holes
- 4 - Bond all Lagscrews with SIKA Supergrip30 to full depth
- 5 - All Fixings must be Stainless steel

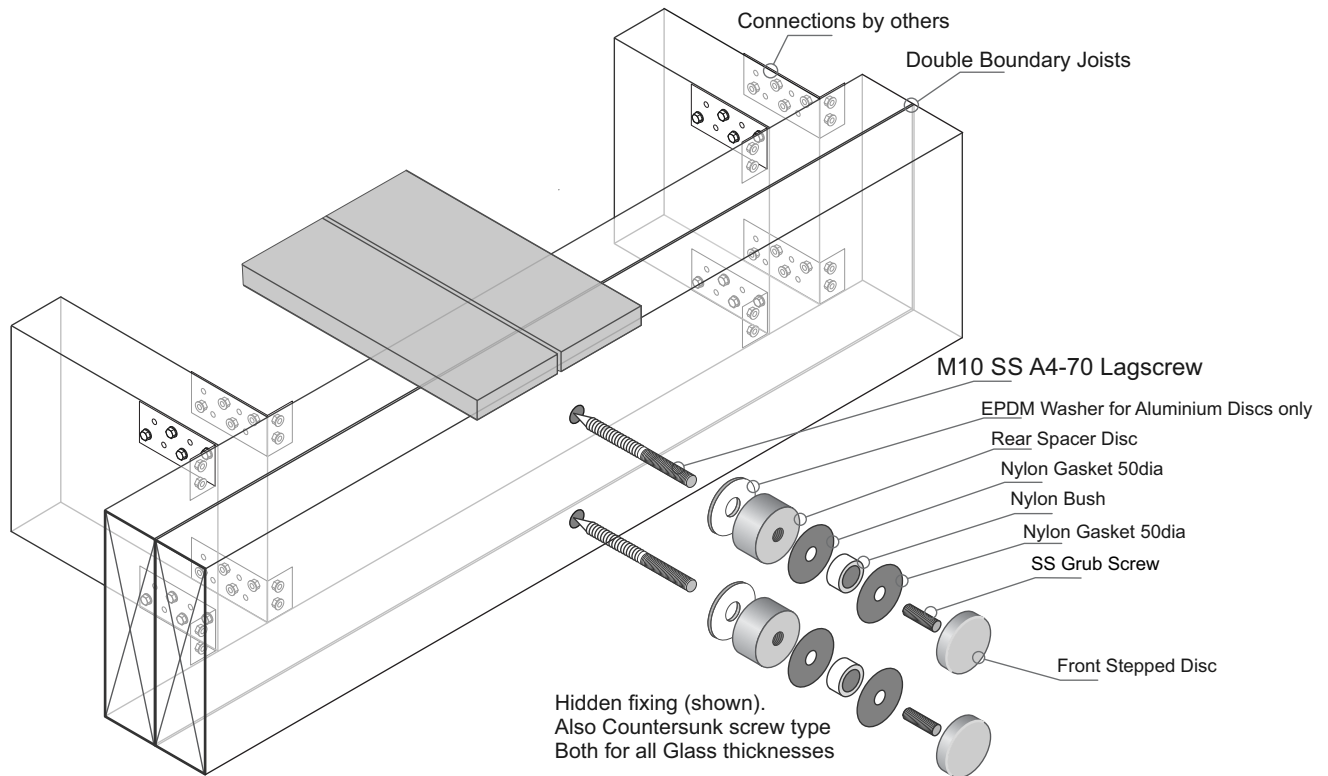

Juralco Edgetec® Double Disc Anchor Balustrade System
Typical Fixing - Residential, Commercial or Pool
Complies with NZS3604:2011 - Double Boundary Joists

Typical FACE Fix to Timber - M10 SS Threaded Rod

Up to and including Very High Wind Zones Residential. Occupancy A,A Other and C3	Up to and including Extra High Wind Zones Commercial. Occupancy B,E and C3
--	--

Glass Thickness, Type	Balustrade Height (max)	Disc Horiz Spacing (max)	Glass Thickness, Type	Balustrade Height (max)	Disc Horiz Spacing (max)
12 T	1150	400	15 T	1250	400
15.2L			17.2L		
13.52SG			17.52SG		

Occupancy A, A Other, B, E and C3. 0.75kN/m

Up to and including High Wind Zone Pool Fence only	Up to and including Extra High Wind Zone Pool Fence only
--	--

Applies to Pool Fences not protecting a fall of 1.0m or more

Glass Thickness, Type	Fence Height (max)	Disc Horiz Spacing (max)	Glass Thickness, Type	Fence Height (max)	Disc Horiz Spacing (max)
12T,15.2L	1250	400	15T,17.2L	1250	400

General Notes:

- 1 - Glass thickness mm
Glass type T= Toughened, L = Laminated
SG = SentryGlas
- 2 - All measurements mm
- 3 - Balustrade Height, above Top Fixing Point
- 4 - Refer to Elevations for Min/Max Panel widths

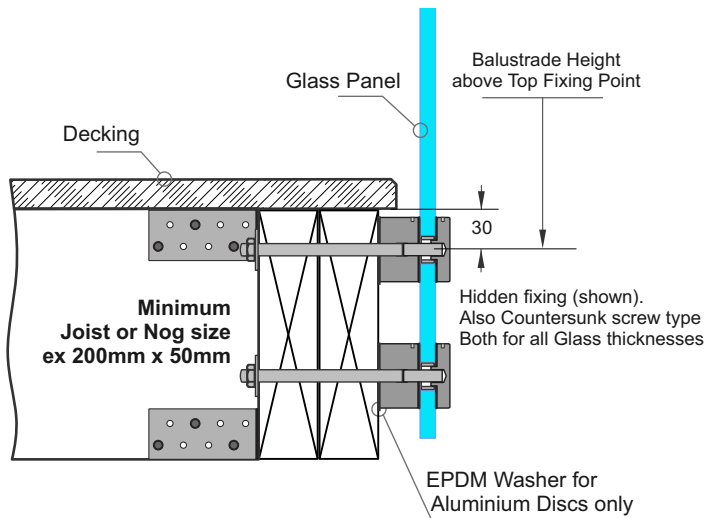

Important Installation notes:

- 1 - The Project Engineer must ensure the structure can support the appropriate loads
- 2 - Substructure shown indicatively only.
Timber SG8 minimum strength
- 3 - All Fixings must be Stainless steel

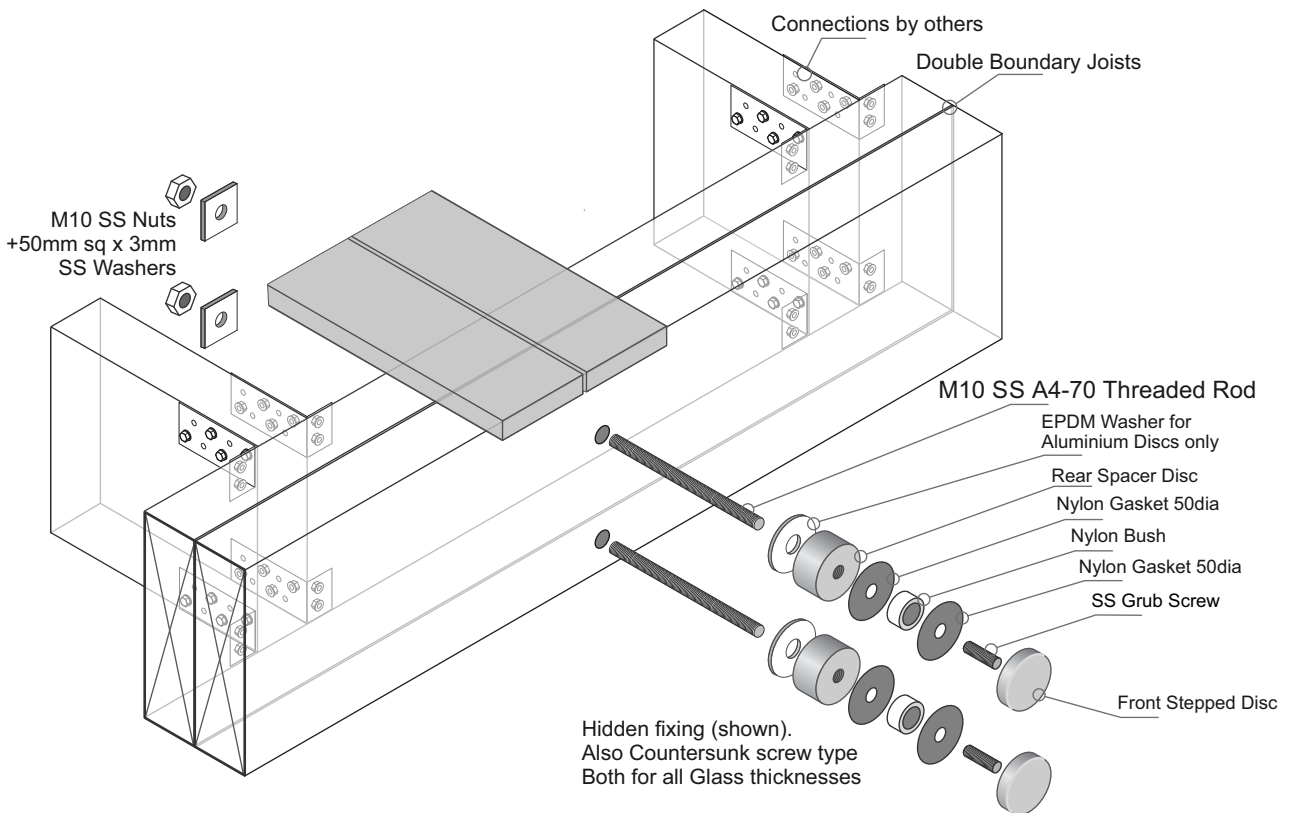

Juralco Edgetec® Double Disc Anchor Balustrade System Typical Fixing - Residential, Commercial or Pool

Typical FACE Fix to Steel - M10 SS Threaded Rod

Up to and including Very High Wind Zones Residential. Occupancy A, A Other and C3			Up to and including Extra High Wind Zones Commercial. Occupancy B, E and C3		
Glass Thickness, Type	Balustrade Height (max)	Disc Horiz Spacing (max)	Glass Thickness, Type	Balustrade Height (max)	Disc Horiz Spacing (max)
12 T	1150	400	15 T	1250	400
15.2L			17.2L		
13.52SG			17.52SG		
Occupancy A, A Other, B, E and C3. 0.75kN/m					

Up to and including High Wind Zone Pool Fence only			Up to and including Extra High Wind Zone Pool Fence only		
Applies to Pool Fences not protecting a fall of 1.0m or more					
Glass Thickness, Type	Fence Height (max)	Disc Horiz Spacing (max)	Glass Thickness, Type	Fence Height (max)	Disc Horiz Spacing (max)
12T, 15.2L	1250	400	15T, 17.2L	1250	400

General Notes:

- 1 - Glass thickness mm
Glass type T= Toughened, L = Laminated
SG = SentryGlas
- 2 - All measurements mm
- 3 - Balustrade Height, above Top Fixing Point
- 4 - Refer to Elevations for Min/Max Panel widths

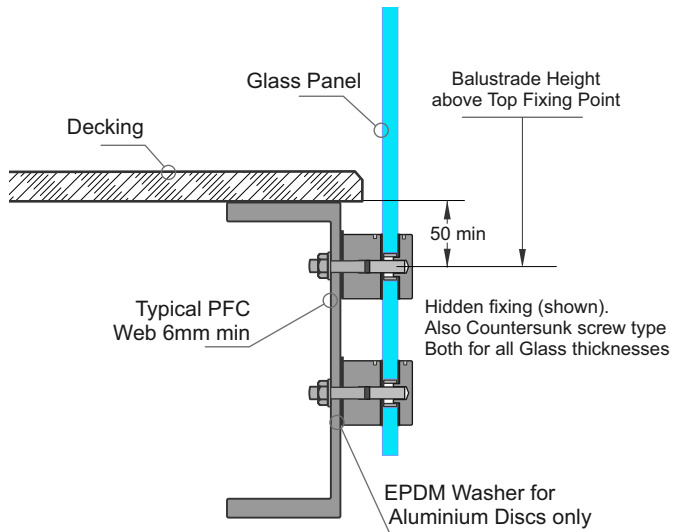

Important Installation Notes:

- 1 - A Project engineer must ensure the structure can support the appropriate loads
- 2 - All fixings must be Stainless Steel

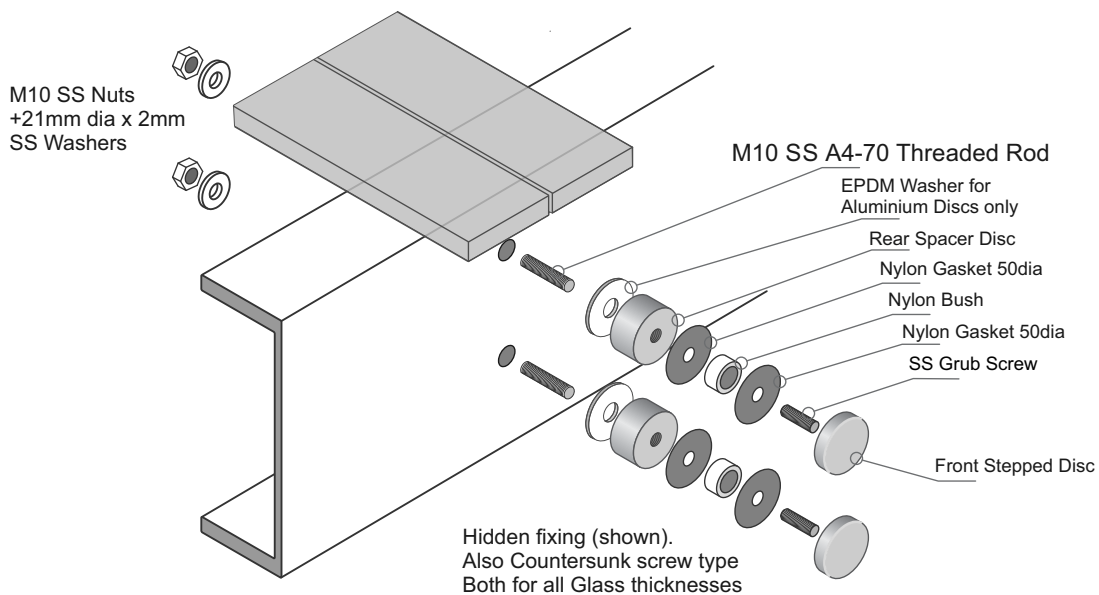

Juralco Edgetec® Double Disc Anchor Balustrade System Typical Fixing - Residential, Commercial or Pool

Typical FACE Fix to Steel - M10 SS Threaded Rod + Tapped Hole

Up to and including Very High Wind Zones Residential. Occupancy A, A Other and C3			Up to and including Extra High Wind Zones Commercial. Occupancy B, E and C3		
Glass Thickness, Type	Balustrade Height (max)	Disc Horiz Spacing (max)	Glass Thickness, Type	Balustrade Height (max)	Disc Horiz Spacing (max)
12 T	1150	400	15 T	1250	400
15.2L			17.2L		
13.52SG			17.52SG		
Occupancy A, A Other, B, E and C3. 0.75kN/m					

Up to and including High Wind Zone Pool Fence only			Up to and including Extra High Wind Zone Pool Fence only		
Glass Thickness, Type	Fence Height (max)	Disc Horiz Spacing (max)	Glass Thickness, Type	Fence Height (max)	Disc Horiz Spacing (max)
12T, 15.2L	1250	400	15T, 17.2L	1250	400

Applies to Pool Fences not protecting a fall of 1.0m or more

General Notes:

- 1 - Glass thickness mm
Glass type T= Toughened, L = Laminated
SG = SentryGlas
- 2 - All measurements mm
- 3 - Balustrade Height, above Top Fixing Point
- 4 - Refer to Elevations for Min/Max Panel widths

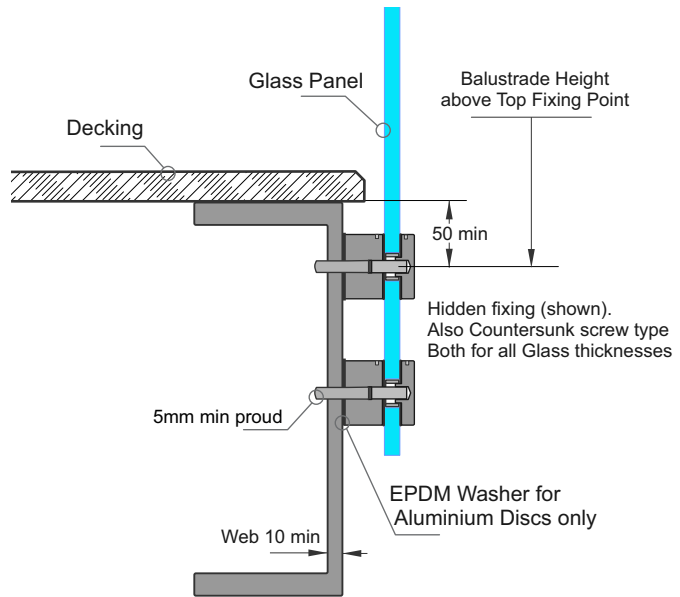

Important Installation Notes:

- 1 - A Project engineer must ensure the structure can support the appropriate loads
- 2 - Thread engagement into Web 10mm min
- 3 - All fixings must be Stainless Steel

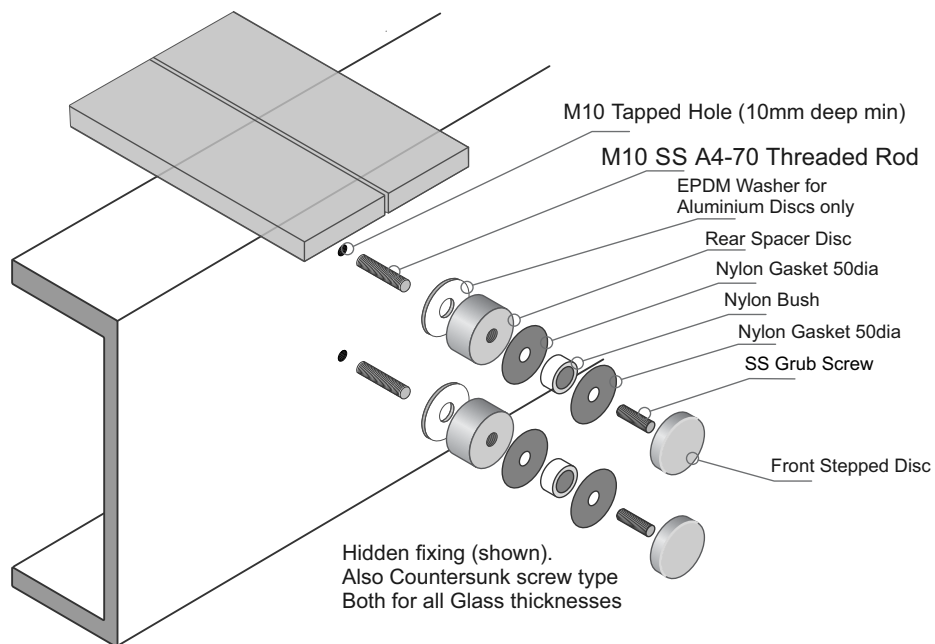

Juralco Edgetec® Double Disc Anchor Balustrade System Typical Fixing - Residential, Commercial or Pool

Typical FACE Fix to Steel, Wooden Packer - M10 SS Threaded Rod

Up to and including Very High Wind Zones Residential. Occupancy A,A Other and C3			Up to and including Extra High Wind Zones Commercial. Occupancy B,E and C3		
Glass Thickness, Type	Balustrade Height (max)	Disc Horiz Spacing (max)	Glass Thickness, Type	Balustrade Height (max)	Disc Horiz Spacing (max)
12 T	1150	400	15 T	1250	400
15.2L			17.2L		
13.52SG			17.52SG		
Occupancy A, A Other, B, E and C3. 0.75kN/m					

Up to and including High Wind Zone Pool Fence only			Up to and including Extra High Wind Zone Pool Fence only		
Glass Thickness, Type	Fence Height (max)	Disc Horiz Spacing (max)	Glass Thickness, Type	Fence Height (max)	Disc Horiz Spacing (max)
12T,15.2L	1250	400	15T,17.2L	1250	400

Applies to Pool Fences not protecting a fall of 1.0m or more

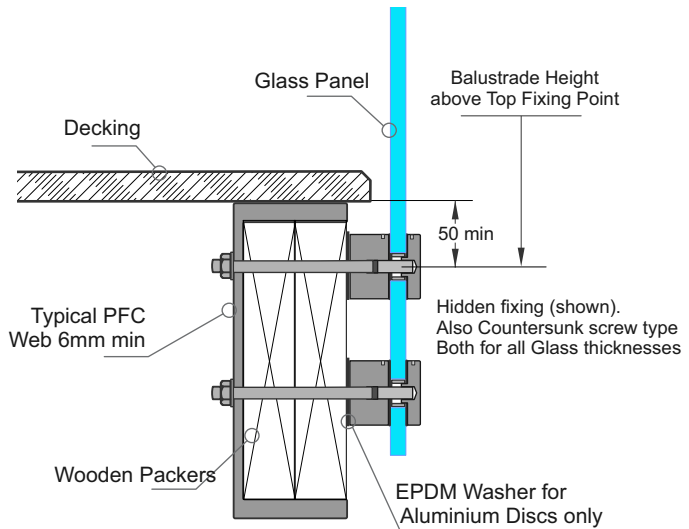

General Notes:

- 1 - Glass thickness mm
Glass type T= Toughened, L = Laminated
SG = SentryGlas
- 2 - All measurements mm
- 3 - Balustrade Height, above Top Fixing Point
- 4 - Refer to Elevations for Min/Max Panel widths

Important Installation Notes:

- 1 - A Project engineer must ensure the structure can support the appropriate loads
- 2 - All fixings must be Stainless Steel
- 3 - Any Cladding/Facing between discs and the Steelwork must have a bearing strength greater than wet MSG8

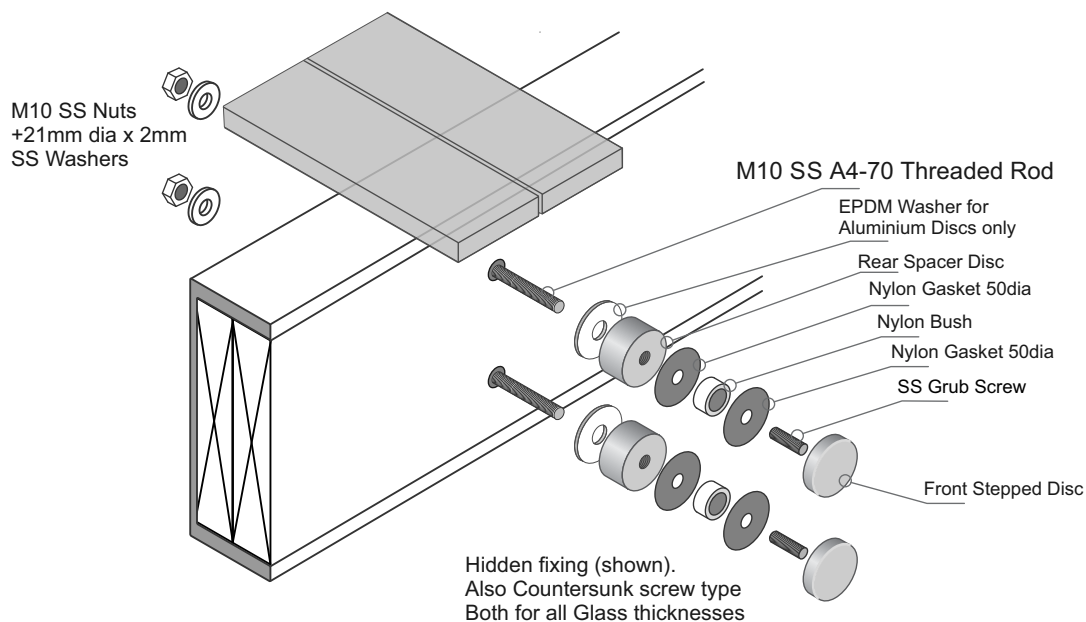

Juralco Edgetec® Double Disc Anchor Balustrade System Typical Fixing - Residential, Commercial or Pool

Typical FACE Fix to Concrete - M10 SS Threaded Rod

Up to and including Very High Wind Zones Residential. Occupancy A, A Other and C3	Up to and including Extra High Wind Zones Commercial. Occupancy B, E and C3
---	---

Glass Thickness, Type	Balustrade Height (max)	Disc Horiz Spacing (max)	Glass Thickness, Type	Balustrade Height (max)	Disc Horiz Spacing (max)
12 T	1150	400	15 T	1250	400
15.2L			17.2L		
13.52SG			17.52SG		

Occupancy A, A Other, B, E and C3. 0.75kN/m

Up to and including High Wind Zone Pool Fence only	Up to and including Extra High Wind Zone Pool Fence only
--	--

Applies to Pool Fences not protecting a fall of 1.0m or more

Glass Thickness, Type	Fence Height (max)	Disc Horiz Spacing (max)	Glass Thickness, Type	Fence Height (max)	Disc Horiz Spacing (max)
12T, 15.2L	1250	400	15T, 17.2L	1250	400

General Notes:

- 1 - Glass thickness mm
Glass type T= Toughened, L = Laminated
SG = SentryGlas
- 2 - All measurements mm
- 3 - Balustrade Height, above Top Fixing Point
- 4 - Refer to Elevations for Min/Max Panel widths



Installation details Fischer FIS V 300T

Thread diameter M10
Drill hole diameter = 12 mm
Drill hole depth = 120 mm
Anchorage depth = 110 mm

Drilling method Hammer drilling
Drill hole cleaning 4 times blowing,
4 times brushing,
4 times blowing

No borehole cleaning required in case of using a hollow drill bit, e.g. fischer FHD.

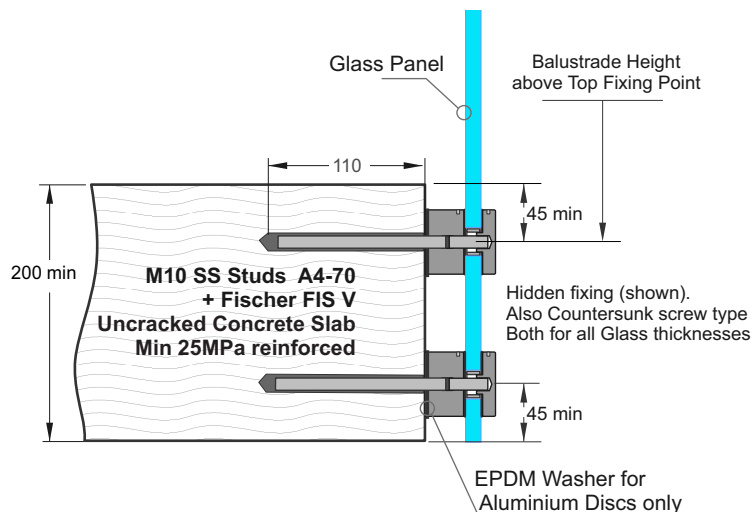

Important Installation Notes:

- 1 - A Project engineer must ensure the structure can support the appropriate loads
- 2 - All fixings must engage into the structural slab.
- 3 - All fixings must be Stainless Steel

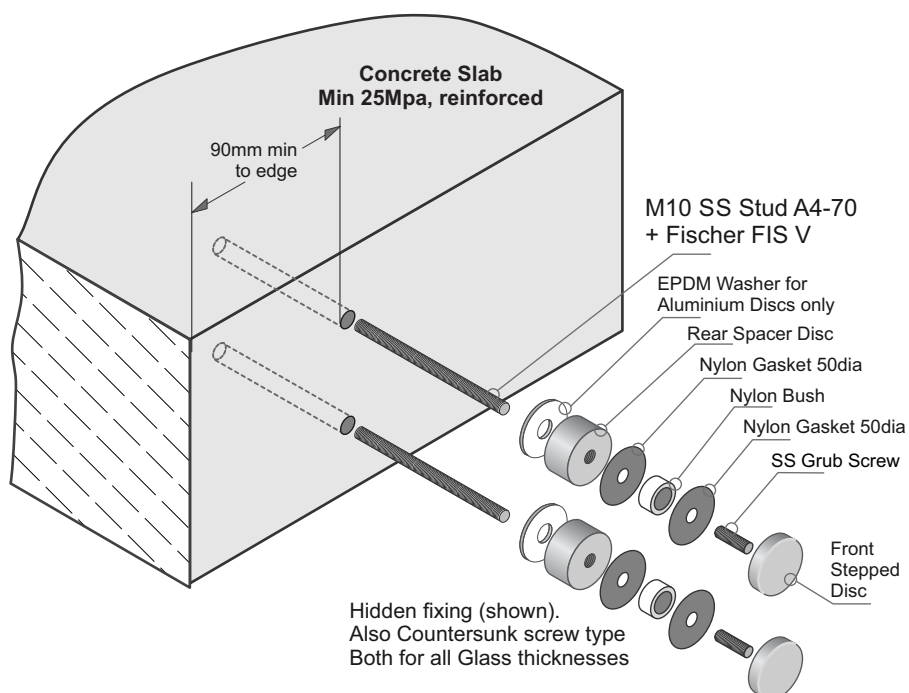

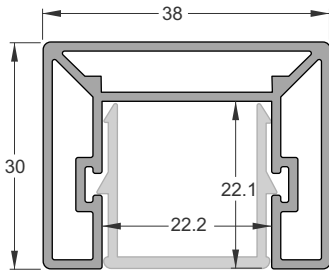

Rectangular Interlinking Top Rail
Part No JET/220/5.8
Also showing Infill Clip, for use in between Glass Panels

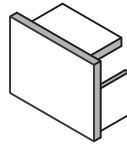

Interlinking Top Rail End Cap
Part No JET 37

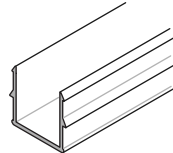

Infill Clip
Part No JET/215/5.8

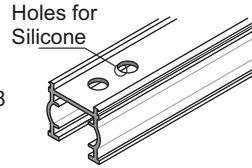

Interlinking Top Rail Gasket for 12 mm Toughened Glass
Part No JET/Gasket 12/2.9

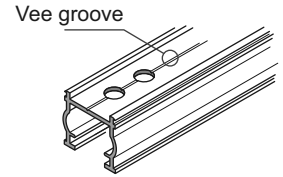

Interlinking Top Rail Gasket for 15 mm Toughened Glass
Part No JET /Gasket 15/2.9

1 - 12, 15mm Glass and Gasket

Application Notes:

- Cut short lengths of Gasket (50mm) and place say every 700mm.
- Cut/adjust Interlinking rail to correct dimensions, test in place.
- Remove all, install full cut lengths of Gasket to glass top edge
- Assemble Top Rail + Joiners and suitable End plates
- Place blobs of V60 silicone in every Gasket hole
- Then place Top Rail extrusion + Joiners and End plates in place clipping firmly to Gasket
- Tape all down, wait 24 hrs to fully bond. Clean up.

Note: Ends must be attached to structure or post,
- Joins must have a suitable joiner plate

12mm Glass and Gasket shown

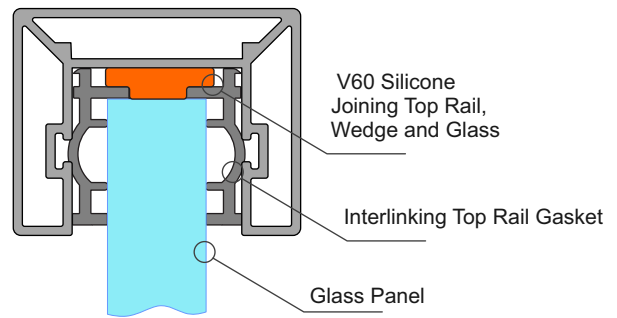

2 - End Plate Brackets

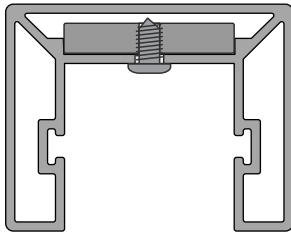

End Plate
Tabs all 22.5 x 4mm SS.

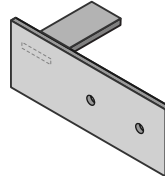

Interlinking Top Rail Wall type End Plate
SS. 120x45mm
JET 40LH

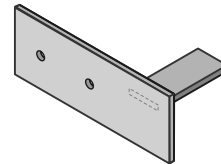

Interlinking Top Rail Wall type End Plate
SS. 120x45mm
JET 40RH

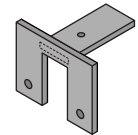

Interlinking Top Rail End Bracket
SS. 60mm x 46mm
JET 42

- End Plates: (After cutting extrusions to length)
- With End Plate in place, spot drill from below for position
 - Drill out to SS tab to 3mm dia, extrusion to 4mm dia
 - Use No 6 x 1/4in SS ST Pan sq drive Screw, 2 per plate.
 - End Plate must be securely attached to Post or structure.

Important Note: All Interlinking rails, at their ends must be attached to a Building Structure or to an Edge Post attached to the Deck structure, using Rail End Plates/Brackets

38mm Rectangular Interlinking Top Rail

This Page applies to 15.2mm and 17.2mm Laminated Safety Glass only

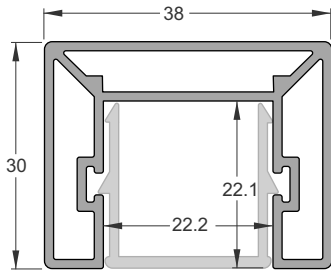

Rectangular Interlinking Top Rail
JET/220/5.8
Also showing Infill Clip, for
use in between Glass Panels

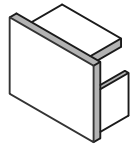

Interlinking Top
Rail End Cap
JET 37

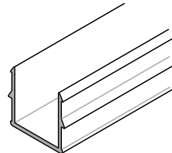

Infill Clip
Part No JET/215/5.8

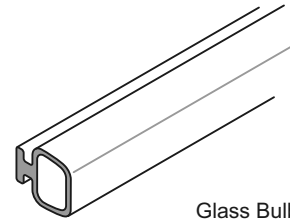

Glass Bulb Seal
Part No JET/IB/CVRBLB250

1 - 15.2, 17.2mm Glass and Gasket

Application Notes:

- Assemble Top Rail + Joiners and suitable End plates
- Place Full lengths of Bulb seal in place.
- Place blobs of V60 silicone along top edge of Glass at similar spacings to Gasket on previous page.
- Then place Top Rail extrusion and bulb seals firmly onto Glass.
- Tape all down, wait 24 hrs to fully bond. Clean up.

Note: Ends must be attached to structure or post,
- Joins must have a suitable joiner plate

15.2mm Glass and Gasket shown

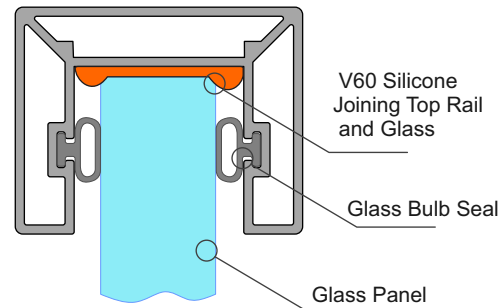

2 - End Plate Brackets

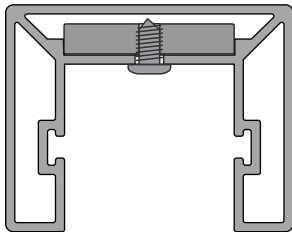

End Plate
Tabs all 22.5 x 4mm SS.

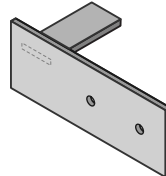

Interlinking Top Rail
Wall type End Plate
SS. 120x45mm
JET 40LH

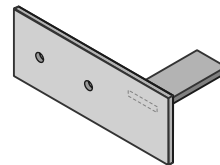

Interlinking Top Rail
Wall type End Plate
SS. 120x45mm
JET 40RH

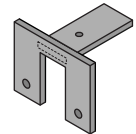

Interlinking Top Rail
End Bracket
SS. 60mm x 46mm
JET 42

End Plates: (After cutting extrusions to length)

- With End Plate in place, spot drill from below for position
- Drill out to SS tab to 3mm dia, extrusion to 4mm dia
- Use No 6 x 1/4in SS ST Pan sq drive Screw, 2 per plate.
- End Plate must be securely attached to Post or structure.

Important Note: All Interlinking rails, at their ends must be attached to a Building Structure or to an Edge Post attached to the Deck structure, using Rail End Plates/Brackets

38mm Rectangular Interlinking Top Rail - Corner Connectors and Joiners

1 - Connectors

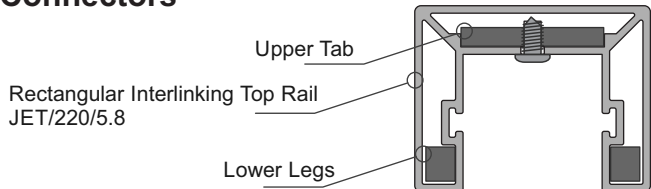

- Swivel Kits: (After cutting extrusions to length)
- With Swivel in place, spot drill from below for position
 - Drill out Swivel to 3mm dia, extrusion to 4mm dia
 - Use No6 x 1/4in SS ST Pan sq drive screws, 2 x ea side of joint
 - Both sides must be attached.
 - Join together with the M6 x 25 C/S SS Screw

Interlinking Top Rail Horizontal Fixed 90 deg Connector JET 45A

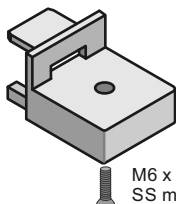

M6 x 25 C/S SS machine screw

Interlinking Top Rail Horizontal Fixed 90 deg Connector JET 45B

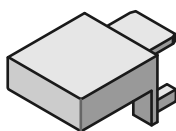

Rectangular Interlinking Top Rail Horizontal Fixed 90deg Kit JET220/90deg Corner Kit (JET 45A and B + screw)

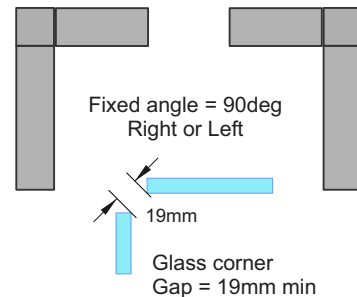
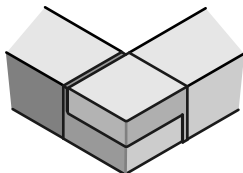

Interlinking Top Rail Horizontal 0 - 90deg Swivel Connector JET 46A

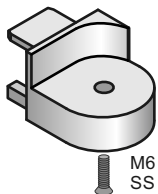

M6 x 25 C/S SS machine screw

Interlinking Top Rail Horizontal 0 - 90deg Swivel Connector JET 46B

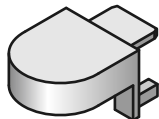

Rectangular Interlinking Top Rail Horizontal 0 - 90 deg Right/Left Swivel Connector Kit JET220/Horizontal Adj Corner Kit (JET 46A and B + screw)

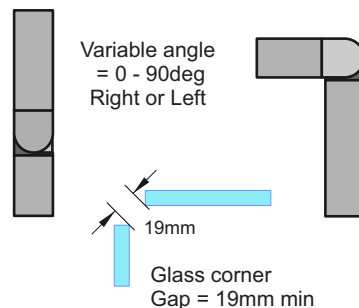
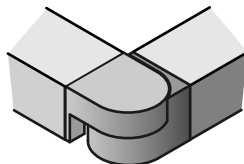

Interlinking Top Rail Vertical 35deg up to 35 deg down Swivel Connector JET 47A

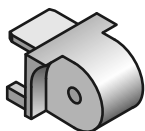

M6 x 25 C/S SS machine screw

Interlinking Top Rail Vertical 35deg up to 35 deg down Swivel Connector JET 47B

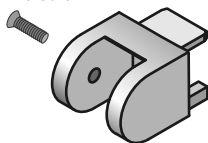

Interlinking Top Rail Vertical 35deg up to 35 deg down. Swivel Connector Kit JET220/Vertical Adj Corner Kit (JET 47A and B + screw)

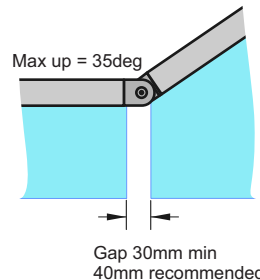
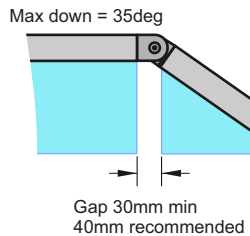
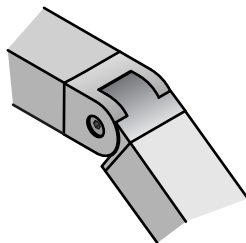

2 - Joiners

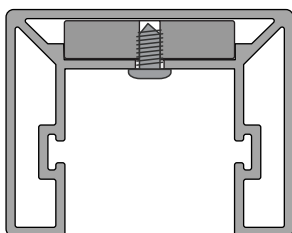

- Joiners: (After cutting extrusions to length)
- With Joiner in place, spot drill from below for position
 - Drill out to joiner to 3mm dia, extrusion to 4mm dia
 - Use No 6 x 1/4in SS ST Pan sq drive screws, 2 x ea side of joint
 - Both ends must be attached.
 - Joins, where required must be at the end of Glass Panels

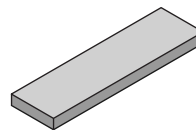

Interlinking Top Rail Straight Joiner 80x22.8x5mm JET 30

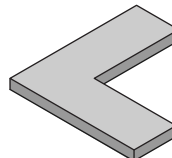

Interlinking Top Rail Corner Joiner 75x75x5mm JET 31

Joiners both 22.5 x 5mm Aluminium

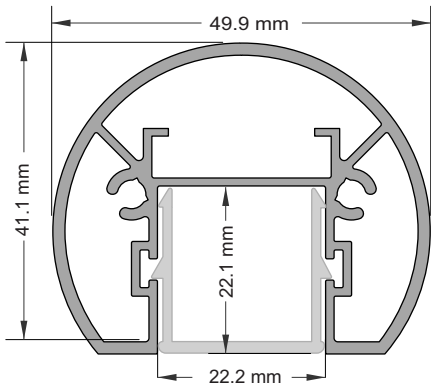

Round Interlinking Top Rail
Part No JET/211/5.8
Also showing Infill Clip, for use in between Glass Panels

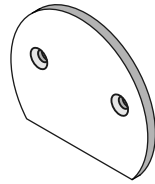

Round Interlinking Top Rail End Cap
Part No JET/231

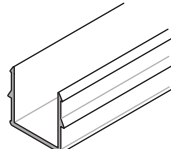

Infill Clip
Part No JET/215/5.8

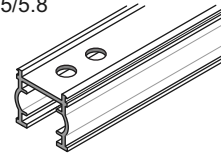

Interlinking Top Rail Gasket for 12 mm Toughened Glass
Part No JET /Gasket 12/2.9

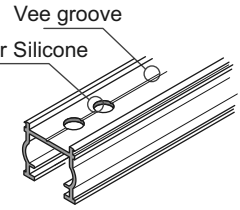

Interlinking Top Rail Gasket for 15 mm Toughened Glass
Part No JET /Gasket 15/2.9

1 - 12, 15mm Glass and Gasket

Application Notes:

- Cut short lengths of Gasket (50mm) and place say every 700mm.
- Cut/adjust Interlinking rail to correct dimensions, test in place.
- Remove all, install full cut lengths of Gasket to glass top edge
- Assemble Top Rail + Joiners and suitable End plates
- Place blobs of V60 silicone in every Gasket hole
- Then place Top Rail extrusion + Joiners and End plates in place clipping firmly to Gasket
- Tape all down, wait 24 hrs to fully bond. Clean up.

Note: Ends must be attached to structure or post,
- Joins must have a suitable joiner plate

12mm Glass and Gasket shown

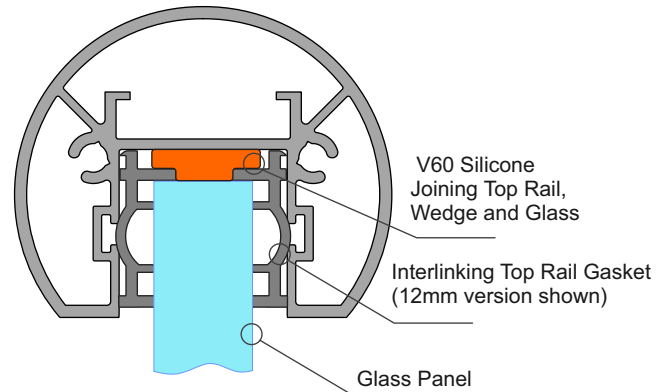

2 - End Plate Brackets

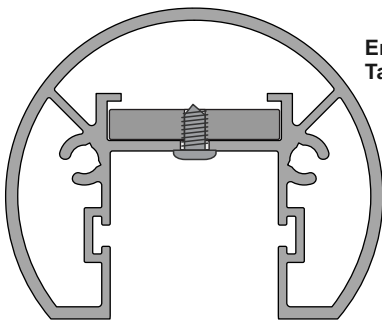

End Plate
Tabs all 22.5 x 4mm SS.

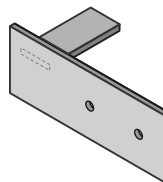

Interlinking Top Rail Wall type End Plate
SS. 120x45mm
JET 40LH

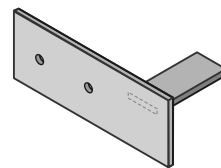

Interlinking Top Rail Wall type End Plate
SS. 120x45mm
JET 40RH

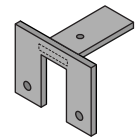

Interlinking Top Rail End Bracket
SS. 60mm x 46mm
JET 42

- End Plates: (After cutting extrusions to length)
- With End Plate in place, spot drill from below for position
 - Drill out to SS tab to 3mm dia, extrusion to 4mm dia
 - Use No 6 x 1/4in SS ST Pan sq drive Screw, 2 per plate
 - End Plate must be securely attached to Post or structure.

Important Note: All Interlinking rails, at their ends must be attached to a Building Structure or to an Edge Post attached to the Deck structure, using Rail End Plates/Brackets

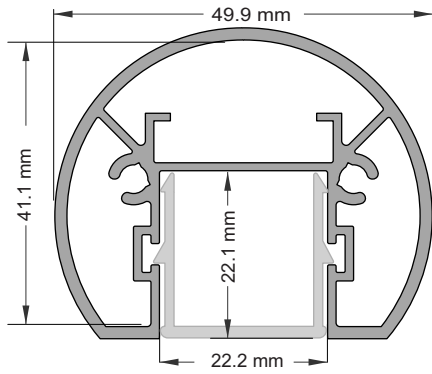

Round Interlinking Top Rail
JET/211/5.8
Also showing Infill Clip, for use in between Glass Panels

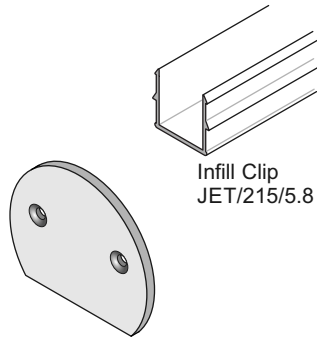

Infill Clip
JET/215/5.8

Round Interlinking Top Rail End Cap
JET 231

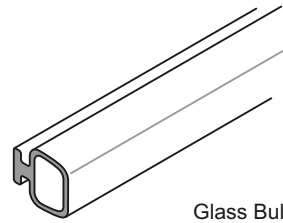

Glass Bulb Seal
JET/IB/CVRBLB250

1 - 15.2, 17.2mm Glass and Gasket

15.2mm Glass and Gasket shown

Application Notes:

- Assemble Top Rail + Joiners and suitable End plates
- Place Full lengths of Bulb seal in place.
- Place blobs of V60 silicone along top edge of Glass at similar spacings to Gasket on previous page.
- Then place Top Rail extrusion and bulb seals firmly onto Glass.
- Tape all down, wait 24 hrs to fully bond. Clean up.

Note: Ends must be attached to structure or post,
- Joins must have a suitable joiner plate

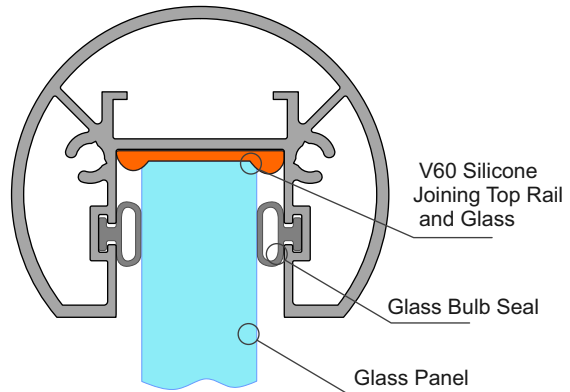

2 - End Plate Brackets

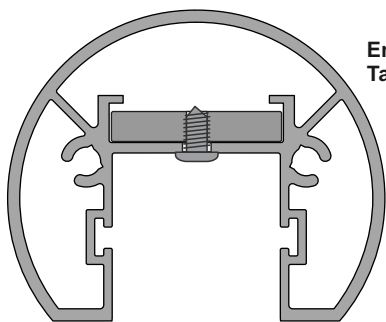

End Plate
Tabs all 22.5 x 4mm SS.

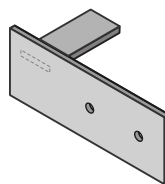

Interlinking Top Rail
Wall type End Plate
SS. 120x45mm
JET 40LH

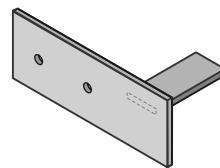

Interlinking Top Rail
Wall type End Plate
SS. 120x45mm
JET 40RH

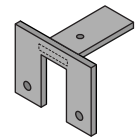

Interlinking Top Rail
End Bracket
SS. 60mm x 46mm
JET 42

- End Plates: (After cutting extrusions to length)
- With End Plate in place, spot drill from below for position
 - Drill out to SS tab to 3mm dia, extrusion to 4mm dia
 - Use No 6 x 1/4in SS ST Pan sq drive Screw, 2 per plate
 - End Plate must be securely attached to Post or structure.

Important Note: All Interlinking rails, at their ends must be attached to a Building Structure or to an Edge Post attached to the Deck structure, using Rail End Plates/Brackets

38mm Rectangular and 50mm Round Interlinking Top Rail - End Bracket Attachments

Applies to 38mm Rectangular and 50mm Round Interlinking Top Rails only

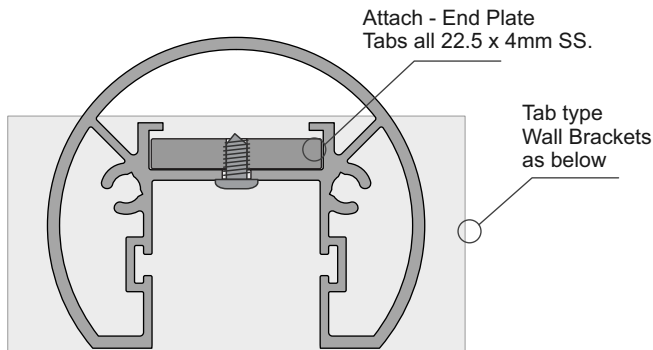

Round Interlinking Top Rail Extrusion
JET/211/5.8

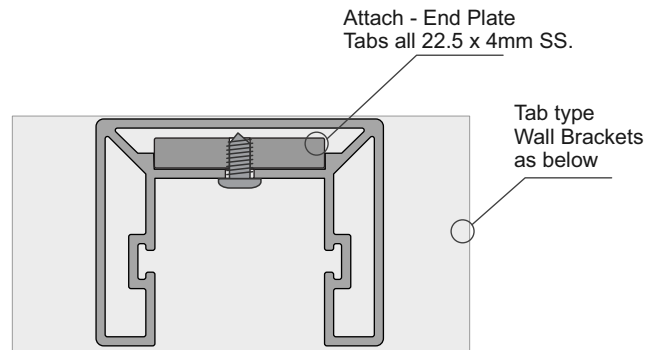

Interlinking Top Rail Extrusion
JET/220/5.8

Interlinking Top Rail End Bracket Options - Both types above - Tab attach Type

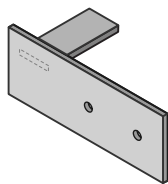

Interlinking Top Rail
Wall type End Plate
SS. 120x45mm
JET 40LH

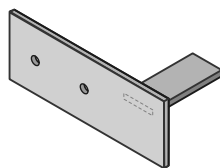

Interlinking Top Rail
Wall type End Plate
SS. 120x45mm
JET 40RH

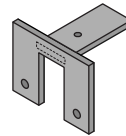

Interlinking Top Rail
End Bracket
SS. 60mm x 46mm
JET 42

Tabs all 22.5 x 4mm SS.
Front faces all 3mm SS

Interlinking Top Rail End Bracket Options - Round Type only - Attach into Screw ports

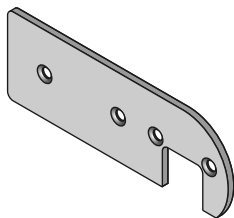

Interlinking Top Rail
Wall type offset End Plate
50mm Round Rail type only
120x42x3mm, Al
C/s both sides = RH or LH
JET 233

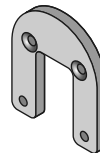

Interlinking Top Rail
Wall type End Plate
50mm Round Rail type only
50x58x5mm, Al
JET 232

General Notes:

- All fixings to be Stainless Steel - PVC Tape layer between Structure and Bracket
- ULS Point load $N^* = 0.9kN$, inwards, outwards or down and in tension

Note : Fixing to Steel

- use 2 off 8g SS TEK Screws or M6 SS Bolts
- Steel 2mm min thickness
- Steel 300MPa minimum
- 15mm min distance to any Edges

Note : Fixing to Timber Wall

- use 2 off 8g SS Screws, 35mm min into studs.
- use Sika Supergrip 2hr
- 30mm min distance to Horizontal Edge
- If Weatherboard use suitable predrilled Wedge
- Timber stud wall to be designed and detailed in accordance with NZS 1720.1:2022 Timber Structures Part 1 - Design methods or NZ3604

Note : Fixing to Juralco EDGE Post

- use 2 off 8g x 25 SS PK Screws

Note : Fixing to Concrete Wall

- use 2 off M6 x70 SS Screw Anchors
- Solid Concrete min 20Mpa
- Block wall Concrete filled/Reinforced
- 140mm min Wall thickness
- 70mm min distance to Horizontal Edge
- 100mm min distance to Vertical Edge
- Blockwork wall must be corefilled /reinforced and is to be designed and detailed in accordance with NZ4230 or NZ4229

Important Note: All Interlinking rails, at their ends must be attached to a Building Structure or to an Edge Post attached to the Deck structure, using Rail End Plates/Brackets

25mm SS Interlinking Top Rail

This page applies to 12mm Toughened Glass only

Small SS Interlinking Top Rail

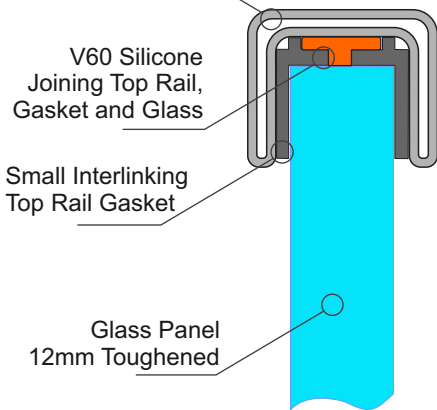

25mm SS Interlinking Top Rail

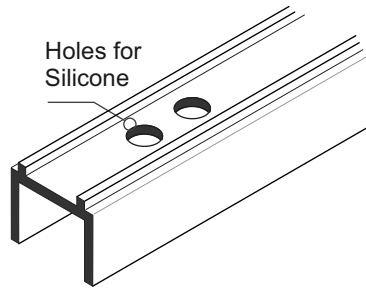

SMALL SS INTERLINKING TOP RAIL GASKET
JET/490GT/12/2.9 (Black)

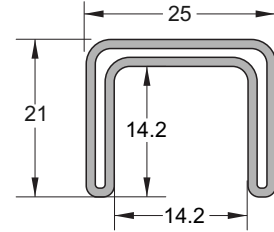

SMALL SS INTERLINKING TOP RAIL
JET/490/5.8/SSS JET/490/5.8/SCC
Duplex 2205

25mm SS Interlinking Rail Connections

Note : All these Brackets use M5 x 6 SS Grub Screws.
If necessary these holes must be Drilled + tapped M5, as shown.
The under side of the Interlinking Rail must be drilled M6 to match M5 tapped holes positions, for access to Grub screws
- Joins, where required must be at the end of Glass Panels
Available as Satin(SSS) or Powdercoated SCC finishes

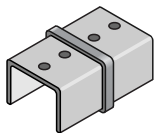
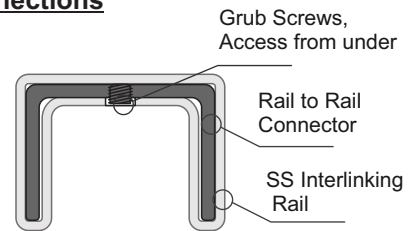

180deg INLINE JOINER
Duplex 2205
JET491/SSS JET491/SCC
21mm x 25mm x 51mm deep

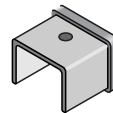

END CAP Duplex 2205
JET492/SSS JET492/SCC
21mm x 25mm x 25mm deep

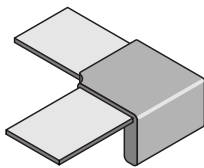

90deg JOINER Duplex 2205
JET493/SSS JET493/SCC
21mm x 80mm x 80mm

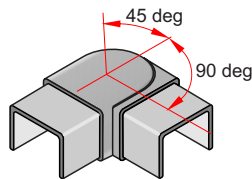

+90 to - 45 deg ADJUSTABLE HORIZONTAL JOINER Duplex 2205
JET494/SSS JET494/SCC
21mm x 25mm x 75mm overall deep

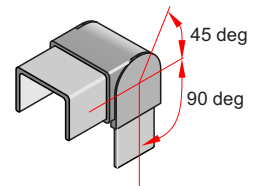

+90 to - 45 deg ADJUSTABLE VERTICAL JOINER Duplex 2205
JET495/SSS JET495/SCC
21mm x 25mm x 73mm overall deep

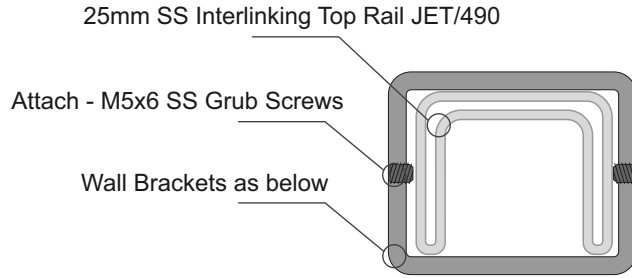

Brackets for Fixing to Wall or End Post for 25mm SS Interlinking Rail

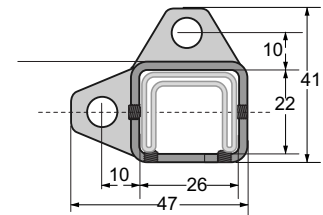
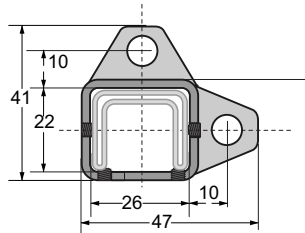
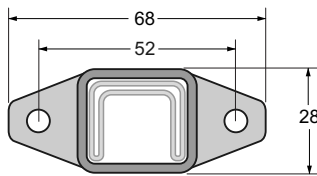

Note : All these Brackets use M5x6mm SS Grub Screws

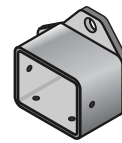
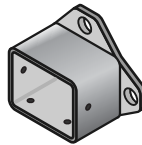
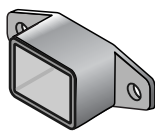

WALL BRACKET Duplex 2205
JET496/SSS JET/496/SCC
68mm x 28mm x 30mm deep

WALL BRACKET - RH. Duplex 2205
JET497/RH/SSS JET497/RH/SCC
41mm x 47mm x 30mm deep

WALL BRACKET - LH Duplex 2205
JET497/LH/SSS JET497/RH/SCC
41mm x 47mm x 30mm deep

General Notes:

- All fixings to be Stainless Steel. - PVC Tape layer between Structure and Bracket
- ULS Point load $N^* = 0.9kN$, inwards, outwards or down and in tension

Note : Fixing to Steel

- use 2 off 8g SS TEK Screws or M6 SS Bolts
- Steel 2mm min thickness
- Steel 300MPa minimum
- 15mm min distance to any Edges

Note : Fixing to Timber Wall

- use 2 off 8g SS Screws, 35mm min into studs.
- use Sika Supergrip 2hr
- 30mm min distance to Horizontal Edge
- If Weatherboard use suitable predrilled Wedge
- Timber stud wall to be designed and detailed in accordance with NZS 1720.1:2022 Timber Structures Part 1 - Design methods or NZ3604

Note : Fixing to Juralco EDGE Post

- use 2 off 8g x 25 SS PK Screws

Note : Fixing to Concrete Wall

- use 2 off M6 x70 SS Screw Anchors
- Solid Concrete min 20Mpa
- Block wall Concrete filled/Reinforced
- 140mm min Wall thickness
- 70mm min distance to Horizontal Edge
- 100mm min distance to Vertical Edge
- Blockwork wall must be corefilled /reinforced and is to be designed and detailed in accordance with NZ4230 or NZ4229

Important Note: All Interlinking rails, at their ends must be attached to a Building Structure or to an Edge Post attached to the Deck structure, using Rail End Plates/Brackets

40mm SS Interlinking Top Rail

This page applies to 12mm and 15mm Toughened Glass and 15.2mm and 17.2mm Laminated Glass only

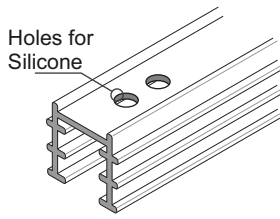

SS Interlinking Top Rail
12mm Glass Gasket
JET/430GT/12/2.9

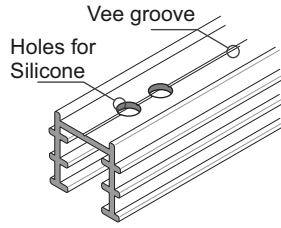

SS Interlinking Top Rail
15mm Glass Gasket
JET/430GT/15/2.9

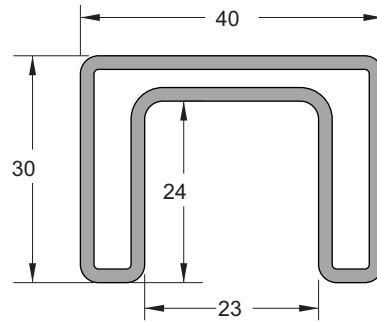

SS INTERLINKING TOP RAIL
JET/430/PSS/5.8

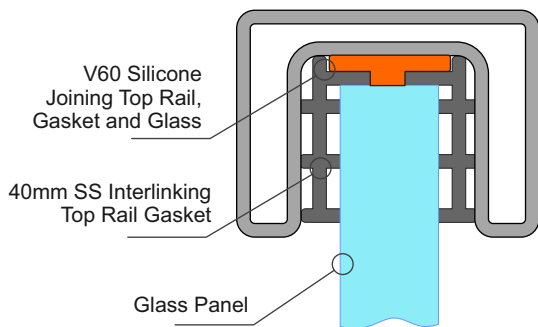

Use Gasket for 12mm and 15mm Toughened Glass

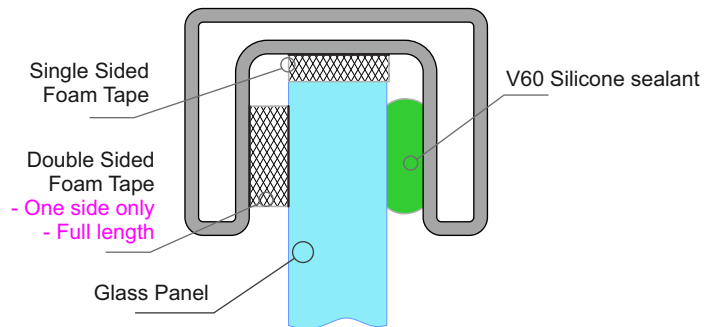

Use Foam Tape for 15.2mm and 17.2mm Laminated Glass

40mm SS Interlinking Rail Connectors

Note : All these Brackets use M5 x 6 SS Grub Screws.
If necessary these holes must be Drilled + tapped M5, as shown.
The under side of the Interlinking Rail must be drilled M6/7 to match M5 tapped holes positions, for access to Grub screws
- Joins, where required must be at the end of Glass Panels

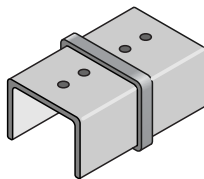
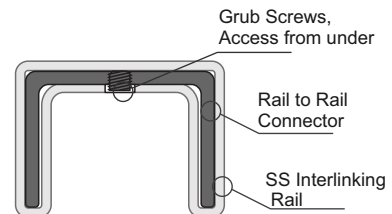

180deg INLINE JOINER 2205
JET/431/PSS
60mm x 40mm x 30mm deep

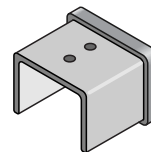

END CAP 2205
JET/432/PSS
33mm x 40mm x 30mm deep

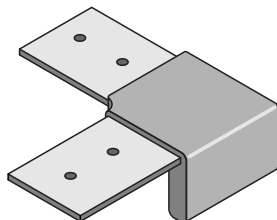

90deg JOINER 2205
JET/433/PSS
95mm x 95mm x 30mm deep

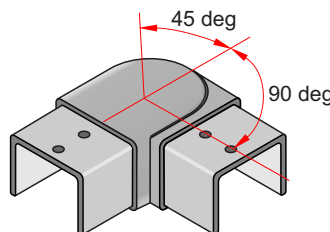

+90 to - 45 deg ADJUSTABLE
HORIZONTAL JOINER 2205
JET/434/PSS
70mm x 70mm x 30mm deep

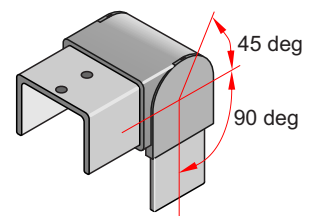

+90 to - 45 deg ADJUSTABLE
VERTICAL JOINER 2205
JET/435/PSS
60mm x 60mm x 40mm wide

40mm SS Interlinking Top Rail - End Brackets

This page applies to 12mm and 15mm Toughened Glass and 15.2mm and 17.2mm Laminated Glass only

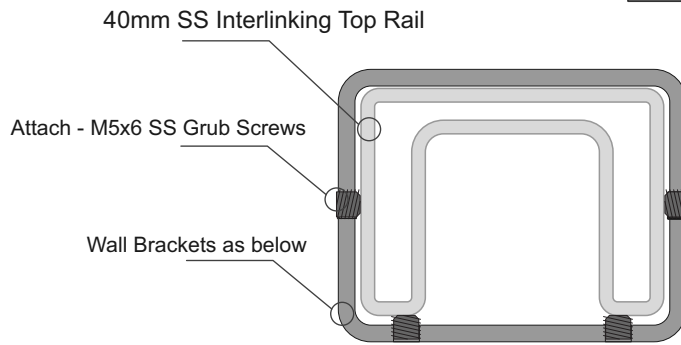

SS INTERLINKING TOP RAIL
Part No JET/430/PSS/5.8

Brackets for Fixing to Wall or End Post for 40mm SS Interlinking Rail

Note : All these Brackets use M5 x 8mm SS Grub Screws

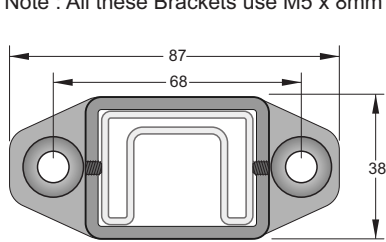

WALL BRACKET 2 FIX 2205
Part No JET/436/PSS
87mm x 37mm x 25mm deep

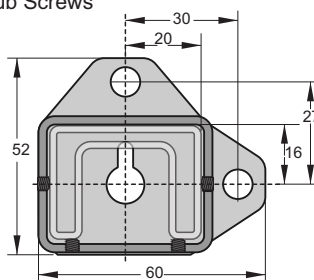

WALL BRACKET 2 FIX - RH 2205
Part No JET/437/RH/PSS
52mm x 60mm x 33mm deep

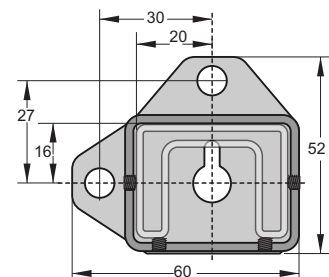

WALL BRACKET 2 FIX - LH 2205
Part No JET/437/LH/PSS
52mm x 60mm x 33mm deep

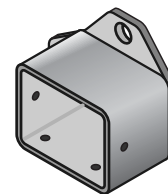
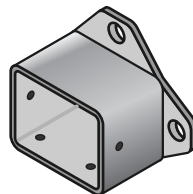
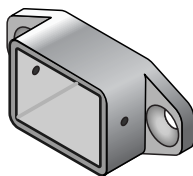

General Notes:

- All fixings to be Stainless Steel - PVC Tape layer between Structure and Bracket
- ULS Point load $N^* = 0.9\text{kN}$, inwards, outwards or down and in tension

Note : Fixing to Steel

- use 2 off 8g SS TEK Screws or M6 SS Bolts
- Steel 2mm min thickness
- Steel 300MPa minimum
- 15mm min distance to any Edges

Note : Fixing to Juralco EDGE Post

- use 2 off 8g x 25 SS PK Screws

Note : Fixing to Timber Wall

- use 2 off 8g SS Screws, 35mm min into studs.
- use Sika Supergrip 2hr
- 30mm min distance to Horizontal Edge
- If Weatherboard use suitable predrilled Wedge
- Timber stud wall to be designed and detailed in accordance with NZS 1720.1:2022 Timber Structures Part 1 - Design methods or NZ3604

Note : Fixing to Concrete Wall

- use 2 off M6 x70 SS Screw Anchors
- Solid Concrete min 20Mpa
- Block wall Concrete filled/Reinforced
- 140mm min Wall thickness
- 70mm min distance to Horizontal Edge
- 100mm min distance to Vertical Edge
- Blockwork wall must be corefilled /reinforced and is to be designed and detailed in accordance with NZ4230 or NZ4229

Important Note: All Interlinking rails, at their ends must be attached to a Building Structure or to an Edge Post attached to the Deck structure, using Rail End Plates/Brackets

Frameless Glass Stiffener Brackets

Top Edge, Frameless Glass Stiffeners
12mm - 15.2mm Glass

- For Laminated or SentryGlas only. Not for Toughened Glass. No Holes in Glass required.
- Install 200mm max from Glass Top edge
- Supplied as a kit, with screws, a variety of Gaskets and a SS clamp Plate
- Duplex 2205 SS construction. Polished, Satin or Powder coat SCC Finishes

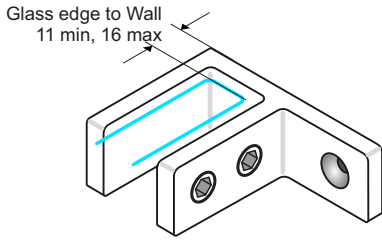

90 Deg Glass to Wall
75x505x25mm
Part No JET72/PSS
Part No JET72/SSS
Part No JET72

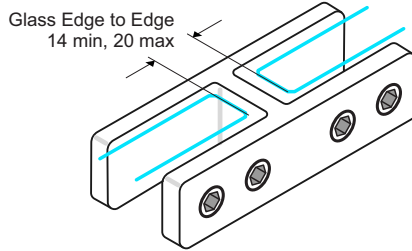

180 Deg Glass to Glass
70x34x25mm
Part No JET71/PSS
Part No JET71/SSS
Part No JET71

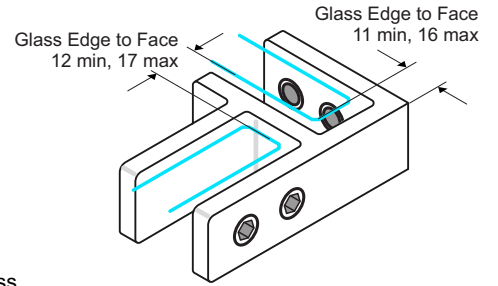

90 deg Glass to Glass
65x55x25mm
Part No JET70/PSS
Part No JET70/SSS
Part No JET70

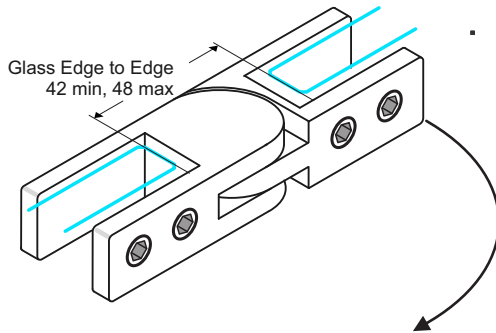

90 - 180 Deg Adjustable Glass to Glass
135x34x25mm
Part No JET73/PSS
Part No JET73/SSS
Part No JET73

Series 70 Glass Stiffener Brackets, Gaskets, Plates			
Thickness	Green Pack	Yellow Pack	Steel Plate
12mm	0	2	1
13.52mm	2	0	1
15, 15.2mm	2	0	1

Top Edge, Frameless Glass Stiffeners
17.2mm - 17.52mm Glass

- For Laminated or SentryGlas only. Not for Toughened Glass. No Holes in Glass required.
- Install 200mm max from Glass Top edge
- Supplied as a kit, with screws, a variety of Gaskets and a SS clamp Plate
- Duplex 2205 SS construction. Polished, Satin or Powder coat SCC Finishes

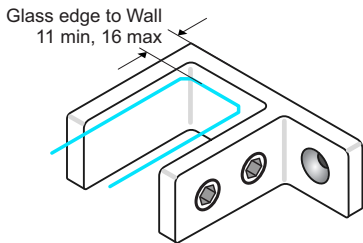

90 Deg Glass to Wall
65x55x25mm
Part No JET82/PSS
Part No JET82/SSS
Part No JET82

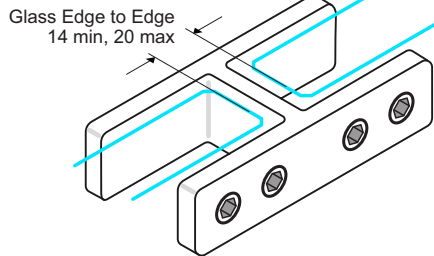

180 Deg Glass to Glass
103x39x25mm
Part No JET81/PSS
Part No JET81/SSS
Part No JET81

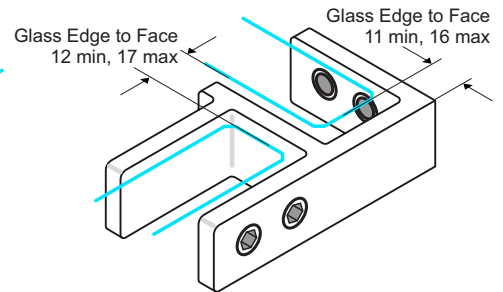

90 deg Glass to Glass
88x55x25mm
Part No JET80/PSS
Part No JET80/SSS
Part No JET80

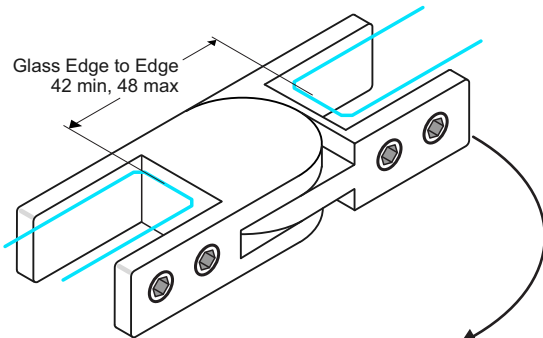

90 - 180 Deg Adjustable Glass to Glass
145x39x25mm
Part No JET83/PSS
Part No JET83/SSS
Part No JET83

Series 80 Glass Stiffener Brackets, Gaskets, Plates			
Thickness	Green Pack	Yellow Pack	Steel Plate
17.2, 17.52mm	0	2	1

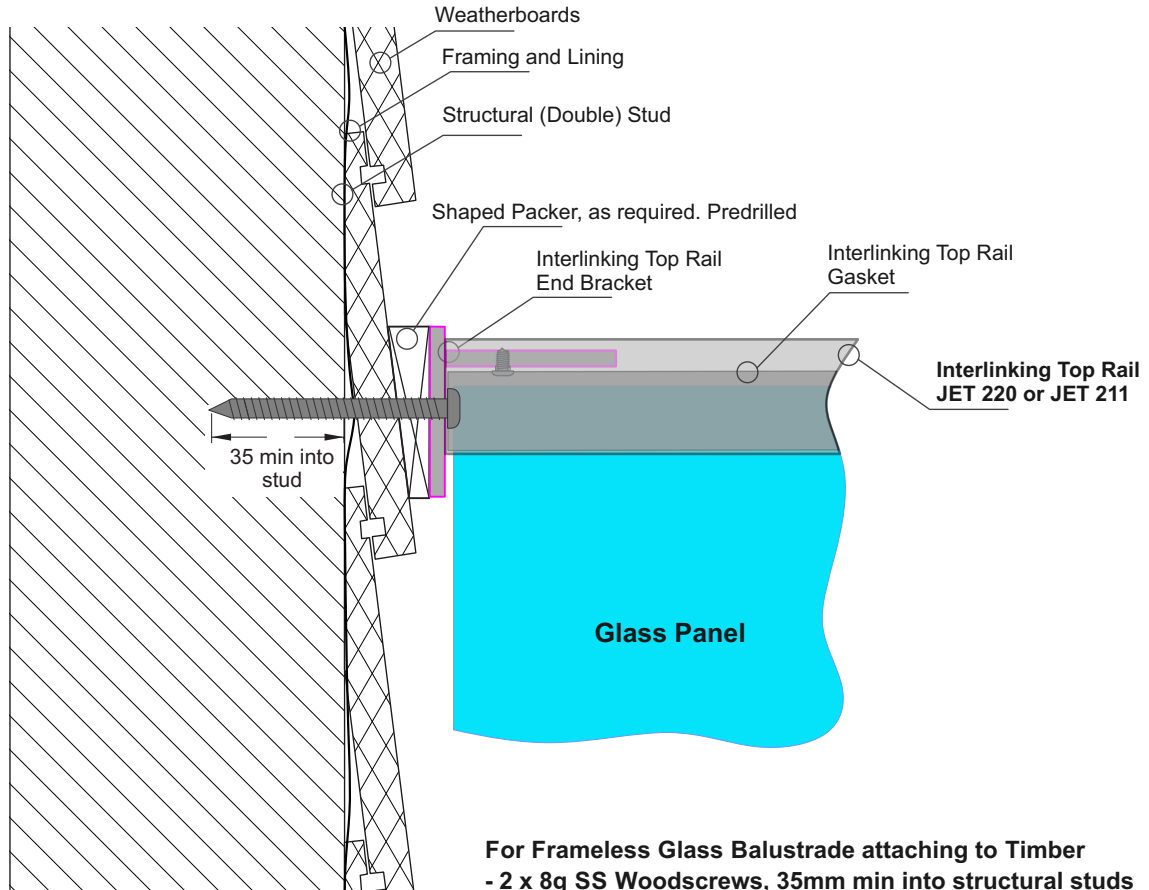

For Frameless Glass Balustrade attaching to Timber
 - 2 x 8g SS Woodscrews, 35mm min into structural studs
 - 20mm min to edge of stud in all directions

Interlinking Top Rail End Bracket Options - Drawing above shows JET40

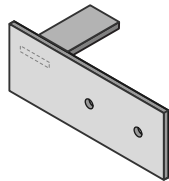

Interlinking Top Rail
Wall type End Plate
SS. 120x45mm
Part No JET 40LH

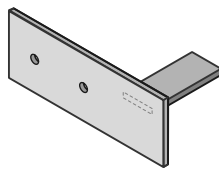

Interlinking Top Rail
Wall type End Plate
SS. 120x45mm
Part No JET 40RH

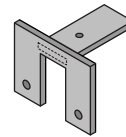

Interlinking Top Rail
End Bracket
SS. 60mm x 46mm
Part No JET 42

Notes:

- All fixings to be stainless steel
- Timber stud wall to be designed by Project structural engineer for loads imposed by Balustrade.
- ULS Point load $N^* = 0.9\text{kN}$, inwards, outwards or down.
- Minimum Stud size = 90mm x 45mm
- Minimum Timber grade = SG8
- Timber stud wall to be designed and detailed in accordance with NZS 1720.1:2022 Timber Structures Part 1 - Design methods or NZ3604

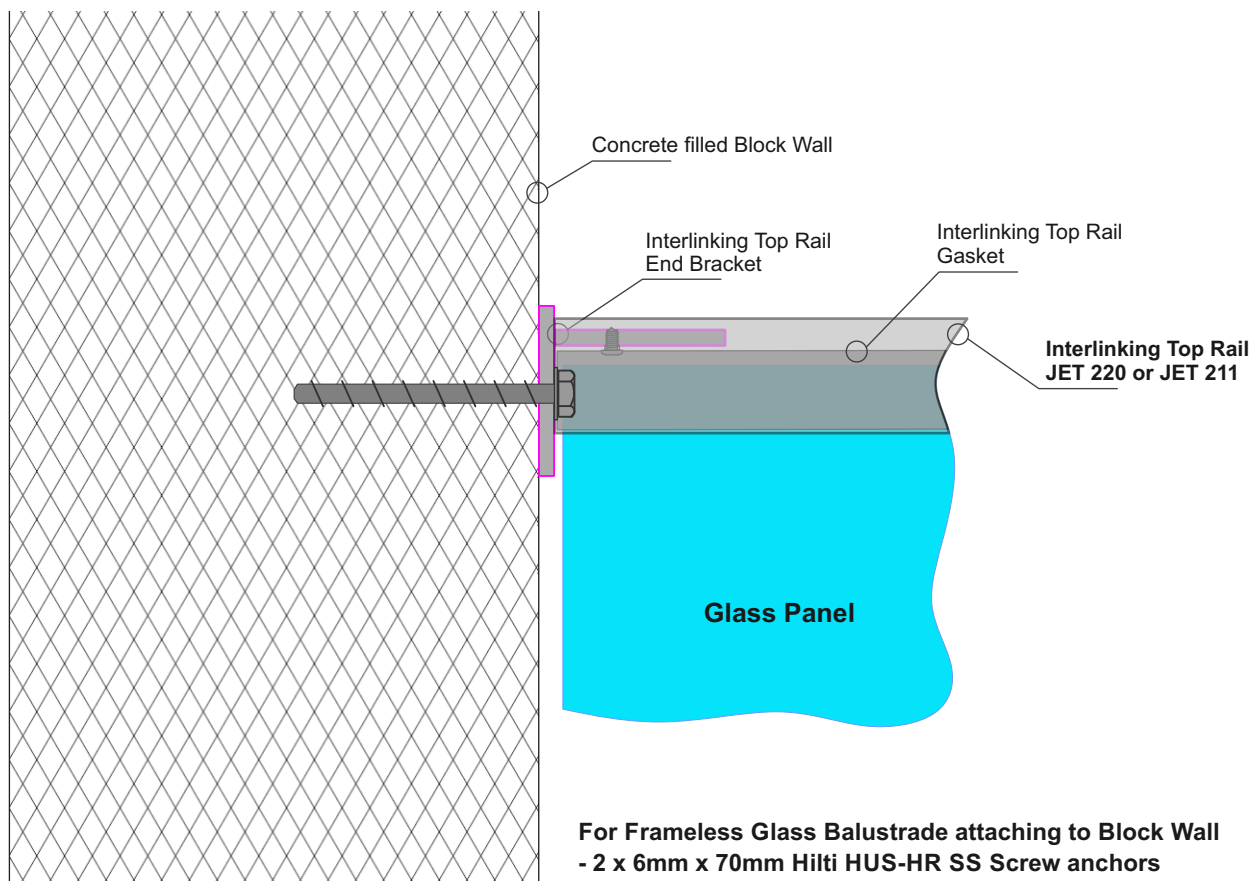

For Frameless Glass Balustrade attaching to Block Wall
 - 2 x 6mm x 70mm Hilti HUS-HR SS Screw anchors
 - For concrete drill 6mmØ holes
 - 70mm min to side edge of concrete, 100mm to top edge.

Interlinking Top Rail End Bracket Options - Drawing above shows JET40

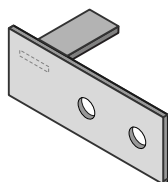

Interlinking Top Rail
 Wall type End Plate
 SS. 120x45mm
 Part No JET 40LH

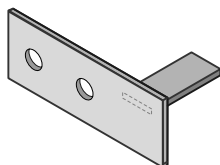

Interlinking Top Rail
 Wall type End Plate
 SS. 120x45mm
 Part No JET 40RH

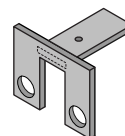

Interlinking Top Rail
 End Bracket
 SS. 60mm x 46mm
 Part No JET 42

Drill out holes to 9mmØ

Notes:

- All fixings to be stainless steel
- Blockwall to be designed by Project structural engineer for loads imposed by Balustrade.
- ULS Point load N* = 0.9kN, inwards, outwards or down.
- Minimum blockwork thickness = 140mm
- Minimum core fill concrete strength = 17.5MPa
- Blockwork wall must be corefilled /reinforced and is to be designed and detailed in accordance with NZ4230 or NZ4229

Juralco Edgetec® Double Disc Anchor Balustrade System
Interlinking Top Rail for attaching to a Edge balustrade End Post
where Wall fixing not suitable

Applies Interlinking Top Rails suitable for
12mm, 15mm Toughened Glass and
15.2mm or 17.2mm Laminated Glass,

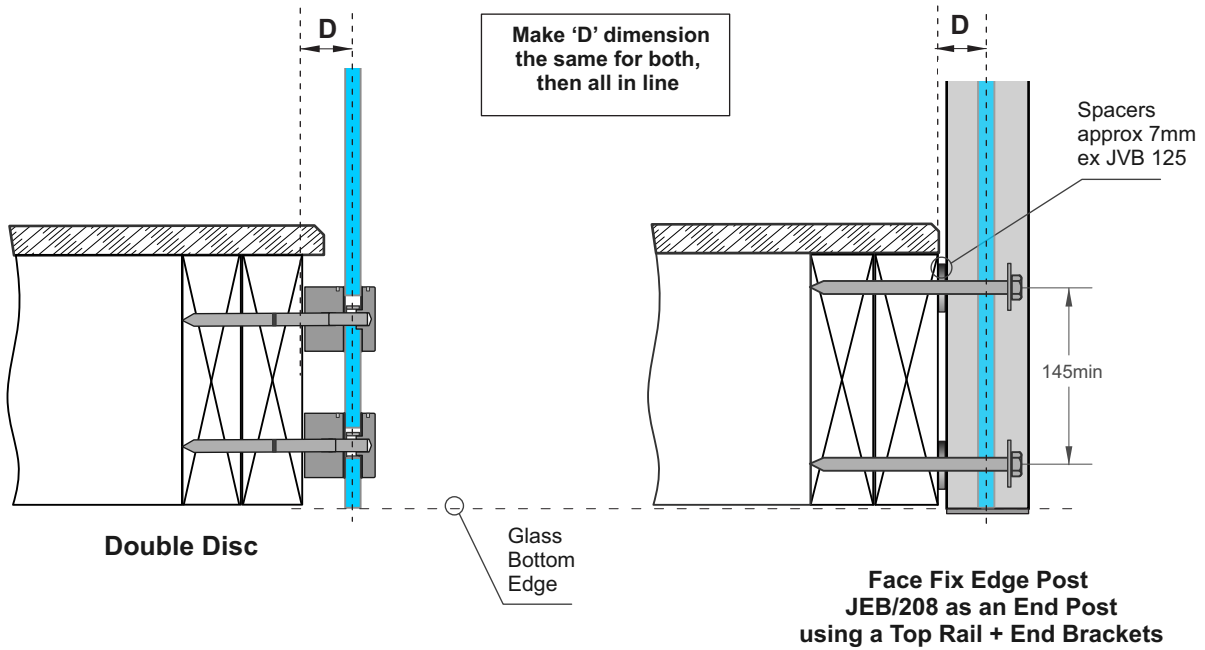

This page applies to 12mm and 15mm Toughened Glass and 15.2mm and 17.2mm Laminated Glass if required

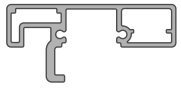

INTERLINKING RAIL
JEB/222/5.8

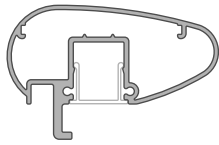

AEROFOIL HANDRAIL
JEB/217/5.8

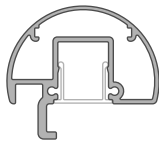

ROUND HANDRAIL
JEB/209/5.8

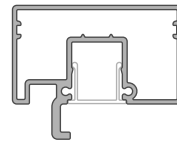

RECTANGULAR
HANDRAIL
JEB/216/5.8

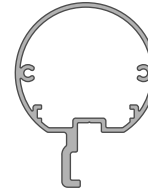

CIRCULAR
HANDRAIL
JEB/221/5.8

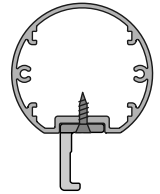

CIRCULAR
HANDRAIL
JEB/223/5.8
+ Clip JEC38

Suitable Interlinking Rail and Handrails (as Interlinking Rails). All from EDGE manual

Interlinking or Handrails on Deck side.

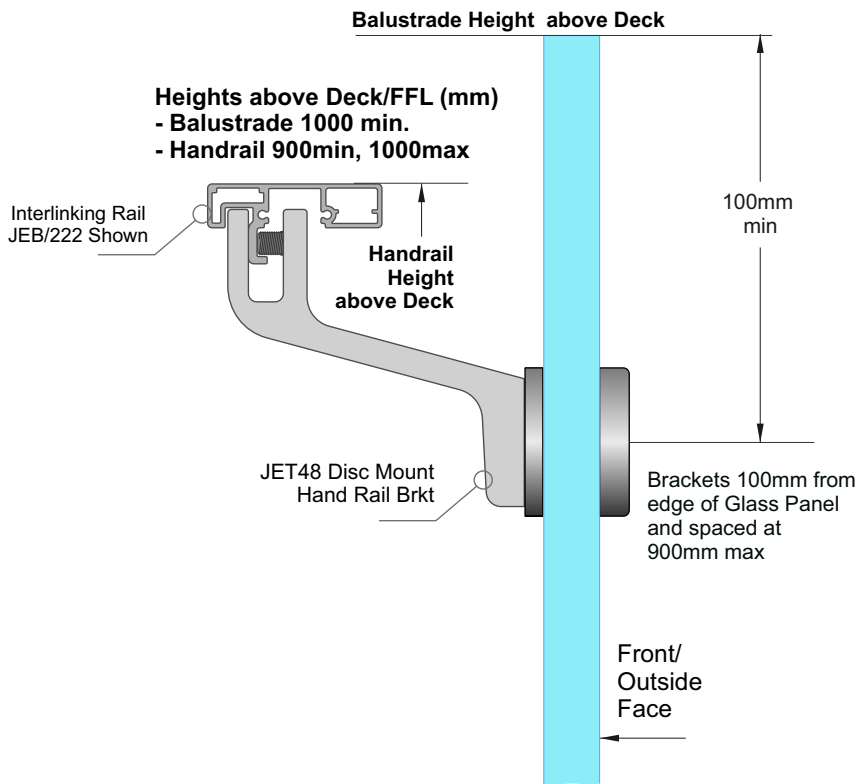

Frameless Glass Systems

Important Note: All Interlinking rails, at their ends must be attached to a Building Structure or to an Edge Post attached to the Deck structure, using Rail End Plates/Brackets. Applies to Handrails used as Interlinking Rails

Handrail Joiners

Rectangular Handrails and 75mm Aerofoil - End Cap, Straight and 90deg corners

All ex 3mm Aluminium

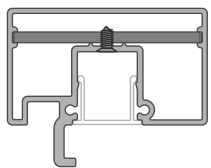

RECTANGULAR HANDRAIL
JEB/216/5.8

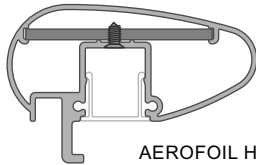

AEROFOIL HANDRAIL
JEB/217/5.8



Rectangular and 75m Aerofoil Inline Joiner
Use 56.5 x 3 flat bar JA/189/5.0

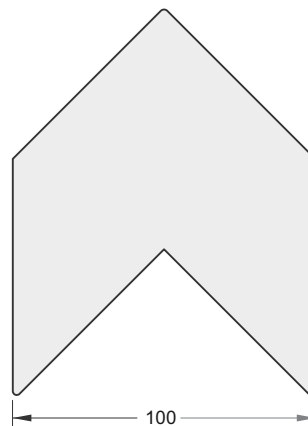

Rectangular and 75m Aerofoil 90deg Corner Joiner JEC 01

Use No6 x 1/4in SS pan sq drive screws, 2 ea side of joint

Round and Circular Handrail, End Cap, Straight and 90deg corners

All ex 3mm Aluminium

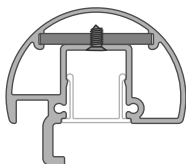

ROUND HANDRAIL
JEB/209/5.8

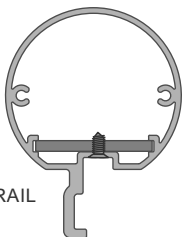

CIRCULAR HANDRAIL
JEB/221/5.8

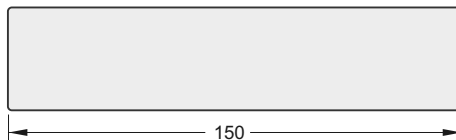

Round and Circular Inline Joiner
Use 34.0 x 3 flat bar JA/188/5.0

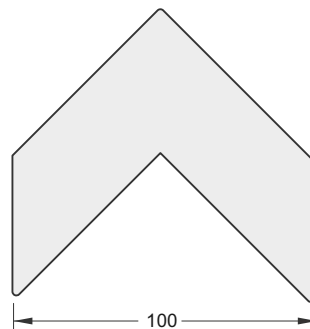

Round and Circular 90deg Corner Joiner JEC 04

Use No6 x 1/4in SS pan sq drive screws, 2 ea side of joint

Interlinking Rail End Cap, Straight 135 deg and 90deg corners

All ex 3mm Aluminium

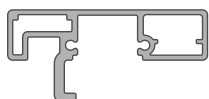

STANDARD HANDRAIL
JEB/222/5.8

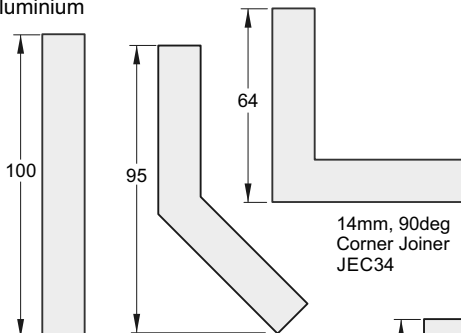
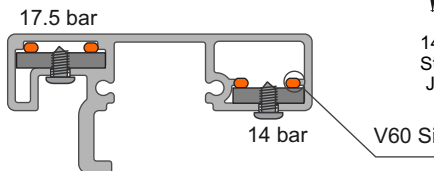

14mm Straight Joiner JEC32

14mm, 135deg Corner Joiner JEC36

14mm, 90deg Corner Joiner JEC34

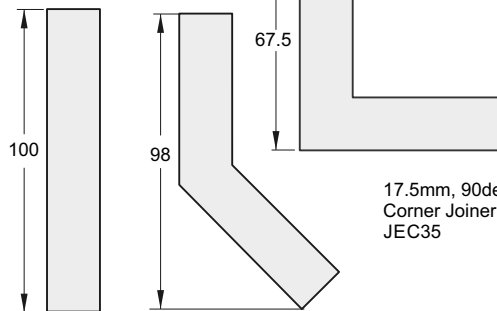

17.5mm Straight Joiner JEC33

17.5mm, 135deg Corner Joiner JEC37

17.5mm, 90deg Corner Joiner JEC35

Joiners:

- With Joiner in place, spot drill from below for position
- Drill out joiner to 3mm dia, extrusion to 4mm dia
- Use No 6 x 1/4in SS ST Pan sq drive screw
- Insert dobs of V60 Silicone inside cavities before inserting
- Both ends to be attached.
- Joins must be within 300mm of Post
- Minimum distance between screw and end of handrail is 10mm



Handrail End Plates for Attaching to a Structure or Edge Deck mounted Post

End Caps for Handrails, Wall or Edge Post attach for JEB 222, 217, 209, 216 and 221 Handrails

End Caps all ex 3mm Aluminium

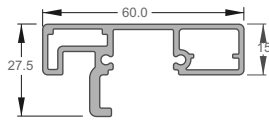

HANDRAIL
Part No JEB/222/5.8

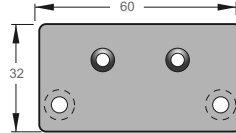

HANDRAIL
WALL ATTACH END PLATE
Part No JEC215/WC

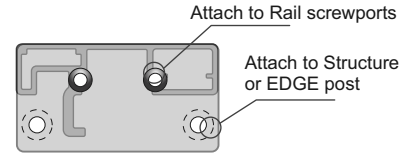

For RH and LH

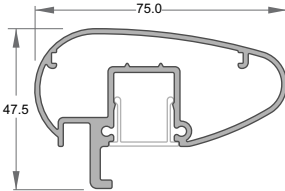

AEROFOIL HANDRAIL
Part No JEB/217/5.8

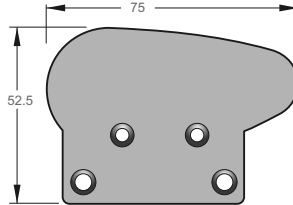

HANDRAIL
WALL ATTACH END PLATE
Part No JEC217/WC

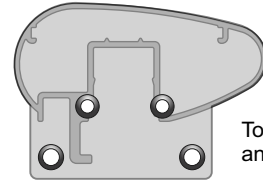

For RH and LH

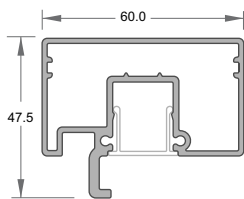

RECTANGULAR
HANDRAIL
Part No JEB/216/5.8

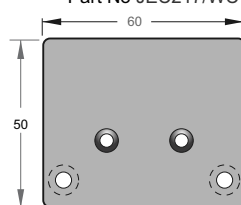

HANDRAIL
WALL ATTACH END PLATE
Part No JEC216/WC

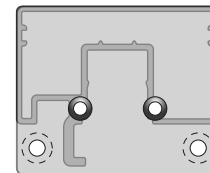

For RH and LH

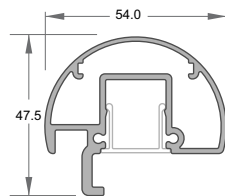

HALF ROUND HANDRAIL
Part No JEB/209/5.8

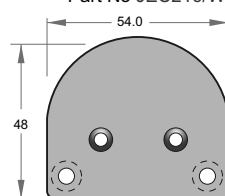

HANDRAIL
WALL ATTACH END PLATE
Part No JEC209/WC

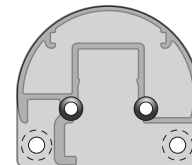

For RH and LH

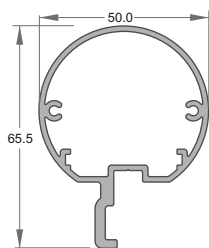

CIRCULAR HANDRAIL
Part No JEB/221/5.8

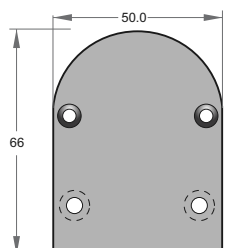

HANDRAIL
WALL ATTACH END PLATE
Part No JEC221/WC

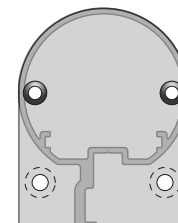

For RH and LH

General Notes: - All fixings to be Stainless Steel. - EPDM layer between Structure and End Cap
- ULS Point load $N^* = 0.9kN$, inwards, outwards or down and in tension

Note : Fixing to Steel

- use 2 off 8g SS TEK Screws or M6 SS Bolts
- Steel 2mm min thickness
- Steel 300MPa minimum
- 15mm min distance to any Edges

Note : Fixing to Timber Wall

- use 2 off 8g SS Screws, 35mm min into studs.
- use Sika Supergrip 2hr
- 30mm min distance to Horizontal Edge
- If Weatherboard use suitable predrilled Wedge
- Timber stud wall to be designed and detailed in accordance with NZS 1720.1:2022 Timber Structures Part 1 - Design methods or NZ3604

Note : Fixing to Juralco EDGE Post

- use 2 off 8g x 25 SS PK Screws

Note : Fixing to Concrete Wall

- use 2 off M6 x70 SS Screw Anchors
- Solid Concrete min 20Mpa
- Block wall Concrete filled/Reinforced
- 140mm min Wall thickness
- 70mm min distance to Horizontal Edge
- 100mm min distance to Vertical Edge
- Blockwork wall must be corefilled /reinforced and is to be designed and detailed in accordance with NZ4230 or NZ4229

Glass Care and Maintenance

Glass Cleaning and Maintenance

Architectural glass products must be properly cleaned during the construction period so visual and aesthetic clarity are maintained. Because glass can be permanently damaged if improperly cleaned, glass producers and fabricators recommend strict compliance with the following procedures.

First, determine whether the glass is clear, tinted or reflective. Surface damage is more noticeable on reflective glass compared with the other glass products. If the reflective coated surface is exposed, either on the exterior or interior, special care must be taken when cleaning, as scratches can result in coating removal and a visible change in light transmittance. Cleaning tinted and reflective glass in direct sunlight should be avoided. Cleaning should begin at the top of the building and continue to the lower levels.

Commence cleaning by soaking the glass surfaces with clean water and a soap solution to loosen dirt or debris. Then, using a mild, non-abrasive commercial window washing solution, uniformly apply the solution to the glass surfaces with a non-abrasive applicator and follow with a squeegee to remove all of the cleaning solution from the glass surface.

Ensure that no metal parts of the cleaning equipment touch the glass surface and that no abrasive particles are trapped between the glass and the cleaning materials. All water and cleaning solution residue should be dried from the window gaskets, sealants and frames.

Scratches and Metal Scrapers

Scratches can occur from hard pointed objects or poor handling, but most often occurs from the careless removal of foreign matter from the glass surface.

Mortar splatter and paint are common offenders and efforts to remove after hardening almost always lead to surface damage. It is essential that the foreign materials are removed before they harden. Better still, if construction work continues after glazing, that the glazed areas are protected by adhesive plastic films or suitable tarpaulins or covers.

One of the common mistakes made by non-glass trades people, including glass cleaning contractors, is the use of razor blades or other metal scrapers on a large portion of the glass surface. Using large blades to scrape a window clean carries considerable risk of causing damage to the glass.

The glass industry, fabricators, distributors and installers neither condones nor recommends any scraping of glass surfaces with metal blades or knives. Such scraping usually permanently damages or scratches the glass surfaces. When paint or other construction materials cannot be removed with normal cleaning procedures, a new 25mm razor blade may have to be used. The razor blade should be used on small spots only. Cleaning should be done in one direction only. Never scrape in a back and forth motion as this could trap particles under the blade that could scratch the glass.

Blades or scrapers can dislodge "pickup" on toughened glass. There are fine particles of glass that are fused on to the surface during toughening. Once dislodged they can scratch the glass.

Glass Cleaning, Do's and Don'ts

DO NOT..

- Do Not - Use Scrapers of any type or size on a Glass surface
- Do Not - Leave building dirt or residues to remain on Glass for a period of time.
- Do Not - Begin cleaning glass until you have identified the surface type.
- Do Not - Clean Glass surfaces in direct sunlight.
- Do Not - Allow dirty water or cleaning residues to remain on the Glass.
- Do Not - Begin cleaning before rinsing off a loose residues.
- Do Not - Use abrasive cleaning solutions, materials or solvents.
- Do Not - Allow metal parts of the cleaning equipment to come in contact with the Glass.
- Do Not - Trap abrasive particles between the cleaning material and the Glass.

DO...

- Clean glass promptly when dirt or building residues appear.
- Determine glass surface type.
- Exercise special care when cleaning coated surfaces.
- Avoid cleaning glass surfaces in direct sunlight.
- Start cleaning at the top of a building, then continue to lower levels.
- Soak the glass surface in a clean soapy solution before cleaning.
- Use a mild non abrasive commercial cleaner.
- Use a squeegee to remove all cleaning solution.
- Try your procedures on a small window and check.
- Caution other trades re the care and protection of the glass surfaces.

**Residues of surface grit may be present from the toughening production process.
These grit particles must not be dragged across the surface.
NEVER use Metal Scrapers**

All above reprinted with permission from Metro Glass Tech

Powder Coating Care and Maintenance

Powder Coating Installation Care

Warning re use of solvents:

- In some cases strong solvents are recommended for thinning various types of paints and also for cleaning up mastics and sealants.
- These can be harmful to the extended life of the powder coated surface, and must not be used for cleaning purposes.
- It is important to note that the damage will not be visible immediately and may take up to 12 months to develop.

If paint splashes or sealants and mastics need to be removed then the following may be safely used: Methylated Spirits, Ethyl Alcohol, Isopropanol or preferably a mild detergent in warm water.

Joinery Protection during Installation:

All the activity on a construction site means that your powder coated items may get knocked or scratched, splattered with mortar, plaster, textured coating or paint during the later stages of construction.

Please ensure that all powder coated articles are masked or covered at this time. It is far easier to prevent accidents than to try and correct them. Should your joinery receive mortar or paint splashes see that these are removed before cure and follow the instructions contained in this brochure.

Typical sticker used to warn other trades of the need to protect and mask off powder coated joinery (applies to anodised joinery also)

"IMPORTANT ALL TRADES"
This valuable aluminium joinery will suffer permanent damage from: plaster, mortar and paint splashes - Protect if splashes occur - Immediately wash down joinery with water or meths - Do not allow splashes to harden! ~ Do not use solvents! - Do not remove this label until final clean completed.

This photograph display damage that has occurred on site, post installation. The photo of the masked joinery displays clear signs of damage that could have occurred were it not masked. Please ensure that your joinery is protected right through the entire construction process.



Powder Coating Maintenance

External - Maintenance Program:

To extend the life of external powder coated articles and to comply with warranty requirements for powder coated aluminium joinery, a simple, regular maintenance program must be implemented.

The effects of ultra violet light, atmospheric pollution, dirt, grime and airborne salt deposits will all accumulate over time and must be removed or surface staining and weathering will occur, leading to an unsightly appearance.

For external coatings, cleaning should take place every six months. In areas where pollutants are more prevalent, such as beachfront houses and industrial or geothermal areas, then a cleaning program should be carried out on a more frequent basis ie. every one to three months.

Cleaning your powder coating:

1. Carefully remove any loose surface deposits with a wet sponge.
2. Use a soft brush (non abrasive) and a mild household detergent (do not use solvents) in warm water, remove dust, salt and other deposits.
3. Rinse off with clean fresh water.



Restoring weathered or scratched surfaces:

Repair of Scuffed or Scratched surfaces
Dulux Spray Cans are available in all colour card colours.

Repair of Small Scratches or Chips.
Dulux Dabsticks are ideally suited for the repair of small scratches.
Dabsticks may not be available in all colour card colours.

Repair of Weathered areas .
Dulux Gloss Up is a light to medium cutting cream ideally suited for gloss restoration and has been specifically designed for this purpose.
Gloss Up contains no waxes or silicone and is a one step system.



Contact Dulux Powder Coatings , ph 0064 9 441 8244

Stainless Steel Care and Maintenance

Care and Maintenance of Stainless Steel

Introduction

Stainless steels are selected for applications where their inherent corrosion resistance, strength and aesthetic appeal are required. However, dependent on the service conditions, stainless steels will stain and discolour due to surface deposits and so cannot be assumed to be completely maintenance-free. In order to achieve maximum corrosion resistance and aesthetic appeal, the surface of the stainless steel must be kept clean. Provided the grade of stainless steel and the surface finish are correctly selected, and cleaning schedules carried out on a regular basis, good performance and long service life will result.

For the correct selection of a Stainless Steel grade, with respect to Location, see Table below.

Factors affecting maintenance

Surface contamination and the formation of deposits on the surface of the stainless steel must be prevented. These deposits may be minute particles of iron or rust generated during construction. Industrial and even naturally occurring atmospheric conditions can produce deposits which can be equally corrosive, e.g. salt deposits from marine conditions.

Working environments can also provide aggressive conditions such as heat and humidity in swimming pool buildings. These conditions can result in surface discolouration of stainless steels and so maintenance on a more frequent basis may be required.

Modern processes use many cleaners, sterilizers and bleaches for hygienic purposes. Proprietary solutions, when used in accordance with makers' instructions, should be safe but if used incorrectly (e.g. warm or concentrated), may cause discolouration or corrosion on stainless steels. Strong acid solutions are sometimes used to clean masonry and tiling of buildings. These acids should never be used where contact with metals, including stainless steel, is possible. If this happens, the acid solution must be removed immediately, followed by dilution and rinsing with clean water.

Stainless Steel Cleaning After Installation

During the installation process finger marks, particle transfers from tools and other building site contaminants may end up being left on the surface of the fittings. These contaminants will allow corrosive elements to stick to the outside of the product increasing the opportunity for brownish spots otherwise known as "tea staining" to occur on the surface.

We recommend after installation to wipe clean the Stainless Steel fittings with either warm soapy water or as small amount of WD40 Multi Use Product applied first to a rag. Take care when cleaning brushed stainless steel to always wipe in the direction of the grain and always remove any cleaning product residue from the glass before finishing up.

Maintenance programme

With care taken during fabrication and installation, cleaning before 'hand-over' should not present any problems. More attention may be required if the installation period has been prolonged or hand-over delayed. Where surface contamination is suspected, immediate cleaning after site fixing should avoid problems later.

The frequency of cleaning is dependent on the application. This may vary from once to four times a year for external applications, Recommendations on cleaning frequencies in architectural applications are shown below.

Cleaning frequency

Recommended Cleaning for various grades of Stainless Steel		
Location	304 Grade	316 Grade
Surbarban or Rural	Clean at 6-12mth intervals or as necessary	
Industrial or Urban	Clean at 3-6mth intervals	Clean at 6-12mth intervals
Coastal or Marine	Not recommended	