

64 Series

Our 64 series accommodates a 64mm stud with a single layer of plasterboard on each side, making it the ideal system for dividing up your office space. With the wide range of profiles, you can achieve exactly the look you want, be it a negative detail, varying door thicknesses or offset glazing when in conjunction with our Acoustic & Edge ranges. Our 64 series is widely used in both commercial office fitouts, and the education sector.

- Suited to 64mm stud
- Designed for ceiling heights up to 3.2m (but not limited to)
- 103mm wide and profile heights of 25mm to 44mm
- Easily accommodates 12.38mm Laminated glass
- Built in screw ports and staking bracket locators
- Negative detail options available
- Seismic head track option available
- Range of options for mullions, transoms & door frames

Standard Suite Profiles - Suitable for: 64mm Steel Stud, 13mm Plasterboard incl. Glazing Profiles

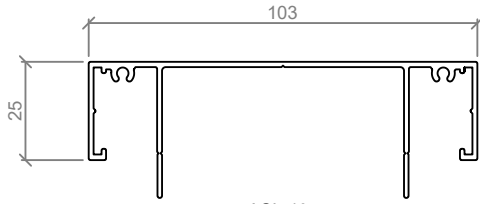

ASL 405
103mm FLUSH HEADSECTION

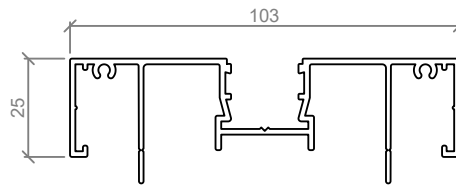

ASL 546
103mm POCKET HEADSECTION

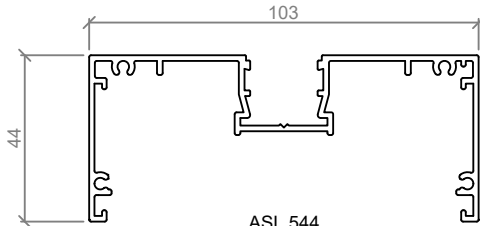

ASL 544
103mm POCKET MULLION

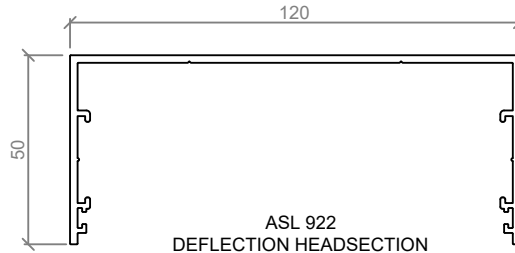

ASL 922
DEFLECTION HEADSECTION

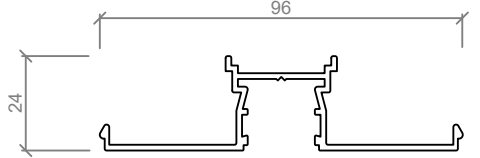

ASL 543
POCKET STARTER CAP

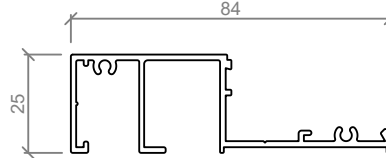

ASL 588
103mm GLAZING BAR

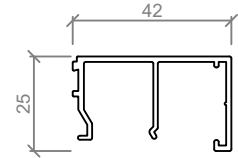

ASL 587
103mm GLAZING BEAD

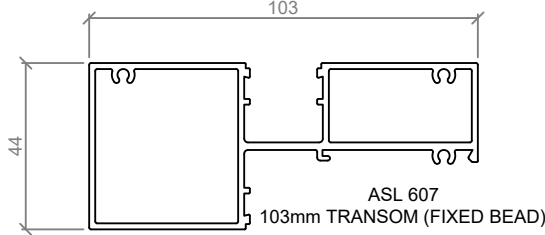

ASL 607
103mm TRANSOM (FIXED BEAD)

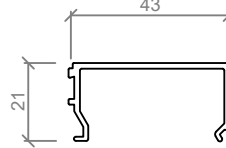

ASL 608
TRANSOM BEAD

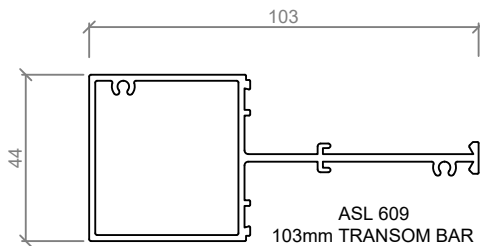

ASL 609
103mm TRANSOM BAR

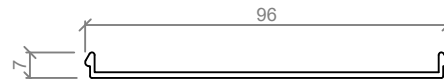

ASL 537
FLUSH STARTER CAP

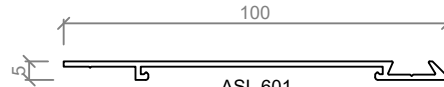

ASL 601
100mm SKIRTING

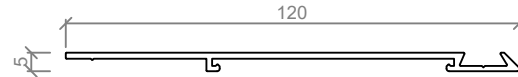

ASL 356
120mm SKIRTING

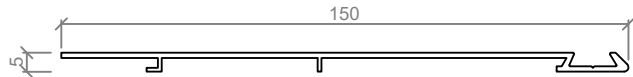

ASL 602
150mm SKIRTING

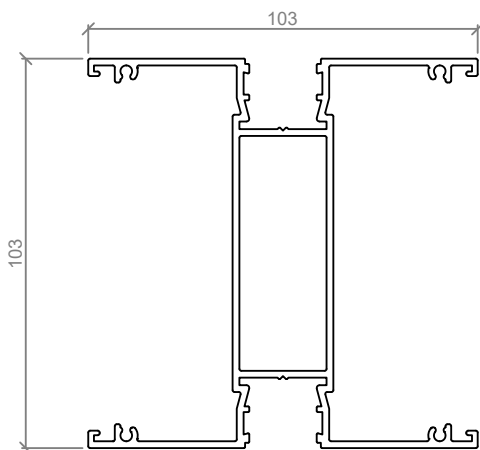

ASL 538
103mm MULTI POST

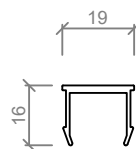

ASL 648
POCKET FLUSH INFILL

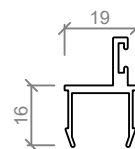

ASL 545
POCKET DOOR STOP
UP TO 40mm DOOR

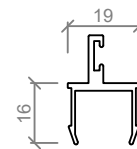

ASL 547
POCKET DOOR STOP
UP TO 50mm DOOR

Negative Detail Profiles - Suitable for: 64mm Steel Stud, 13mm Plasterboard

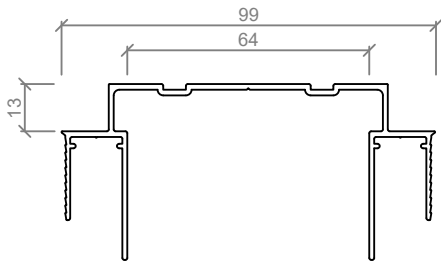

ASL 740
GROOVED HEADSECTION (13mm NEG. DETAIL)

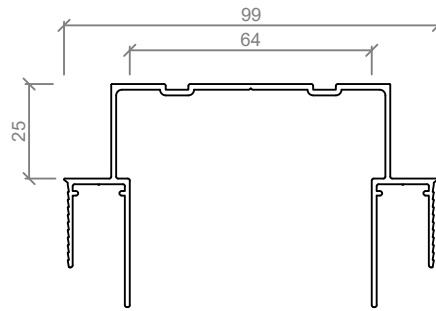

ASL 754
GROOVED HEADSECTION (25mm NEG. DETAIL)

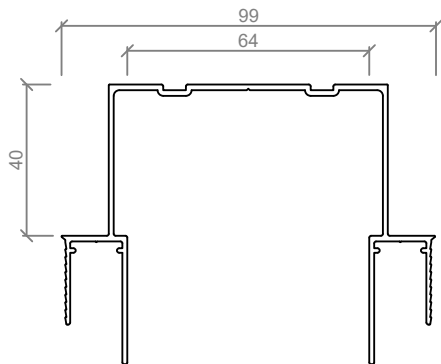

ASL 742
GROOVED HEADSECTION (40mm NEG. DETAIL)

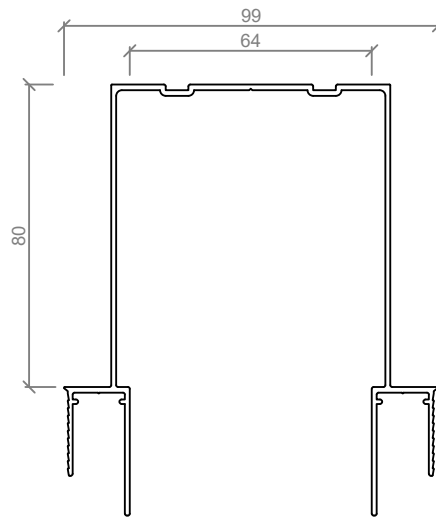

ASL 749
GROOVED HEADSECTION (80mm NEG. DETAIL)

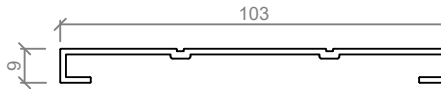

ASL 745
FLUSH CAP (USE WITH PSL 64-740)

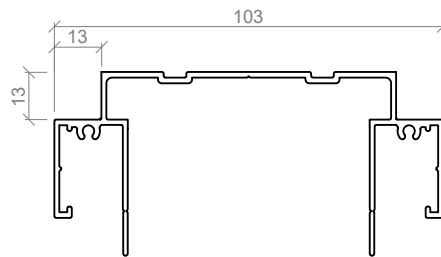

ASL 407
103mm SHADOWLINE HEADSECTION

Standard Elevation

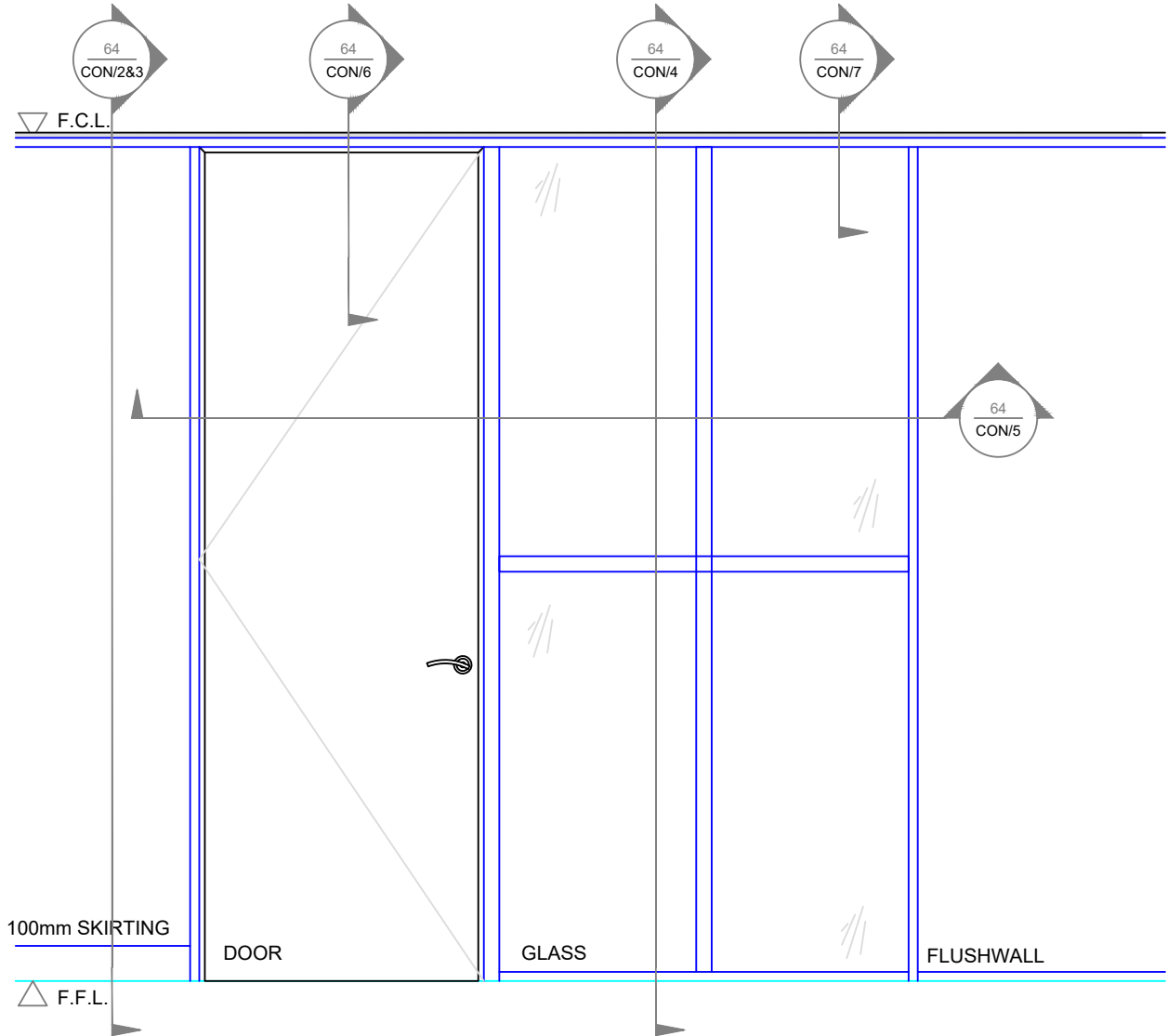

Standard Detail - Headsection Wall - 13mm Plasterboard with Skirting

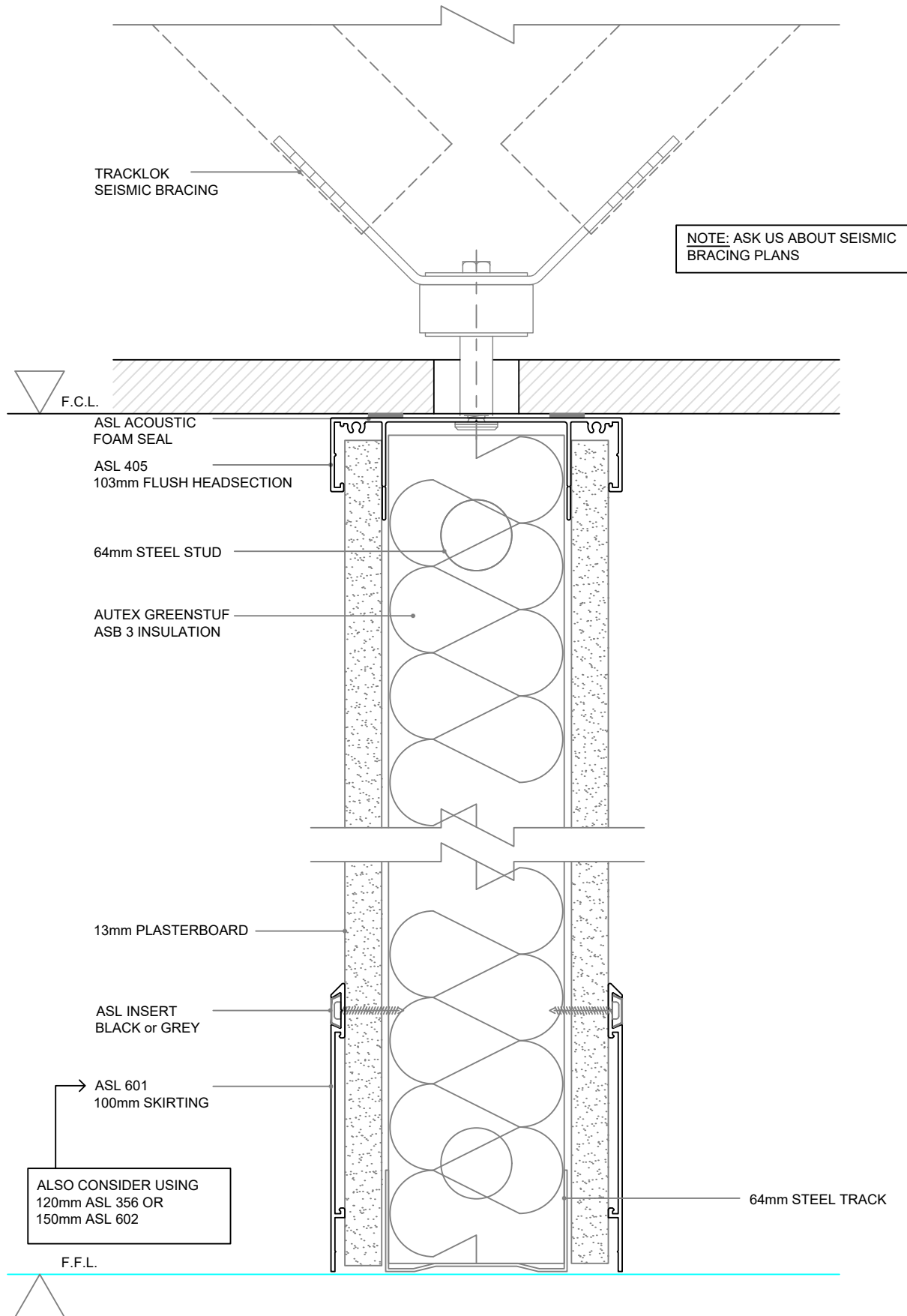

Standard Details Negative Detail Headsection Wall - 13mm Plasterboard with negative detail

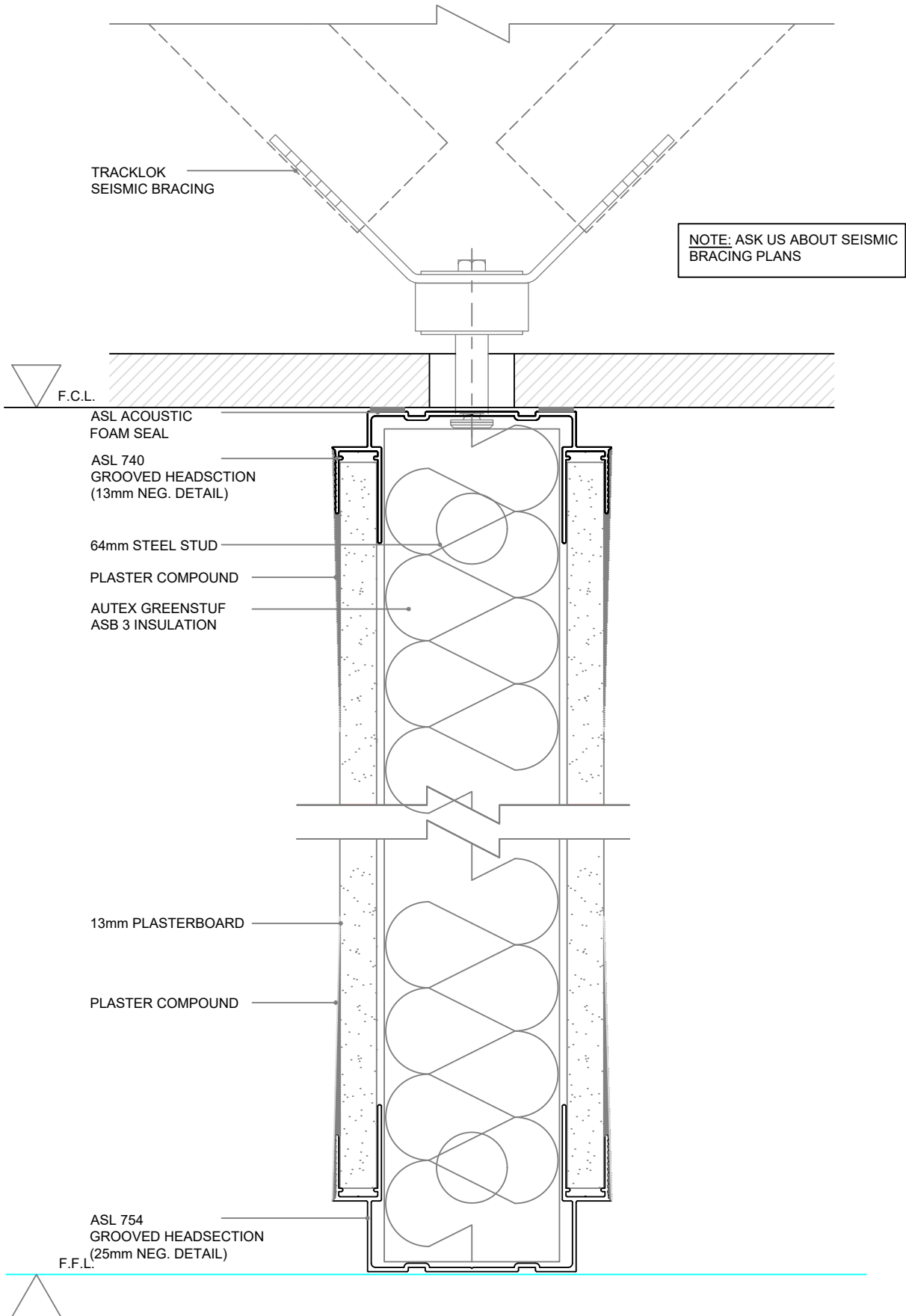

Standard Details Glazed Vertical Wall with transom

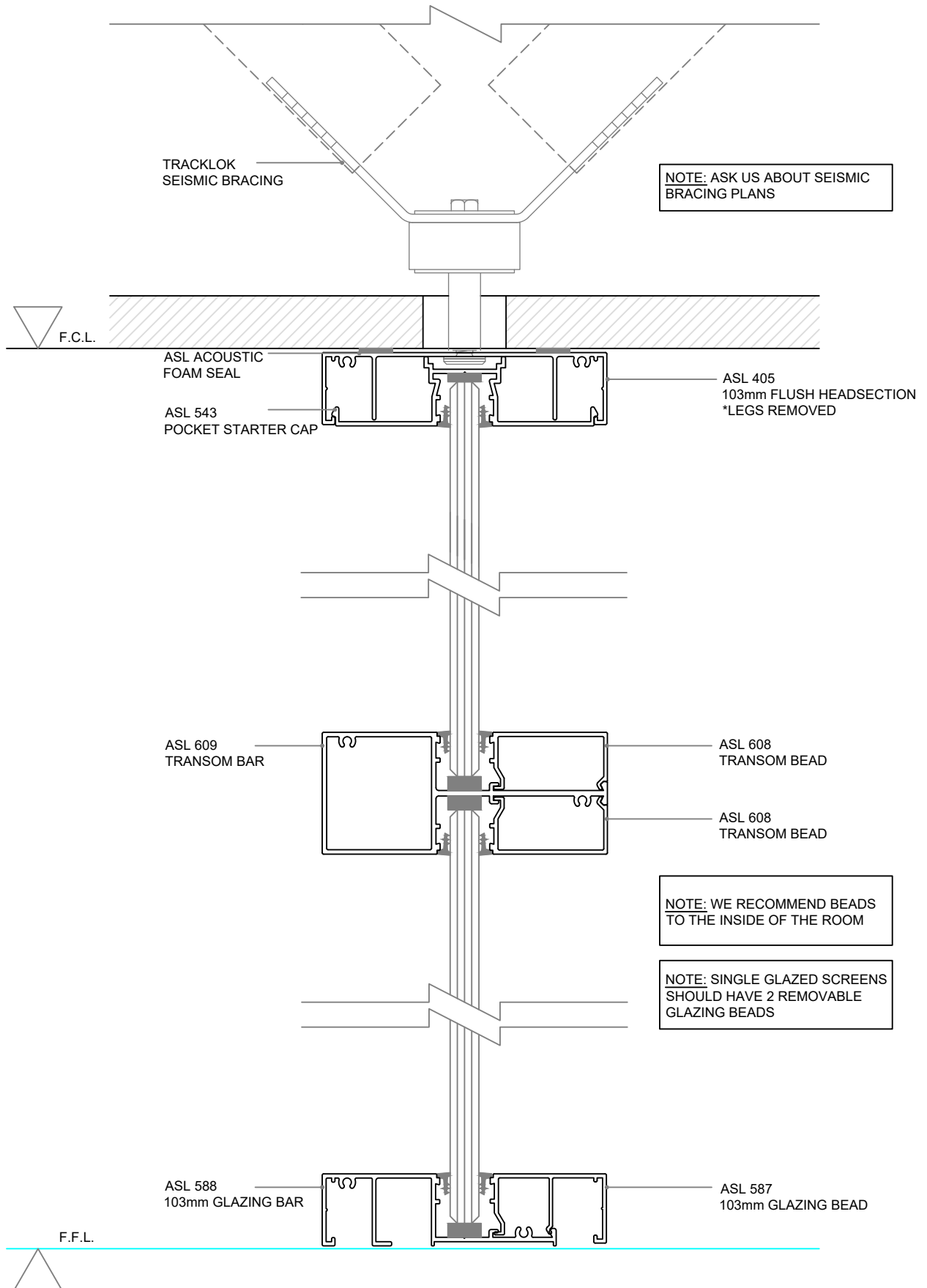

Standard Details - 64mm Steel Stud, Glazing, Solid Door, 13mm Plasterboard

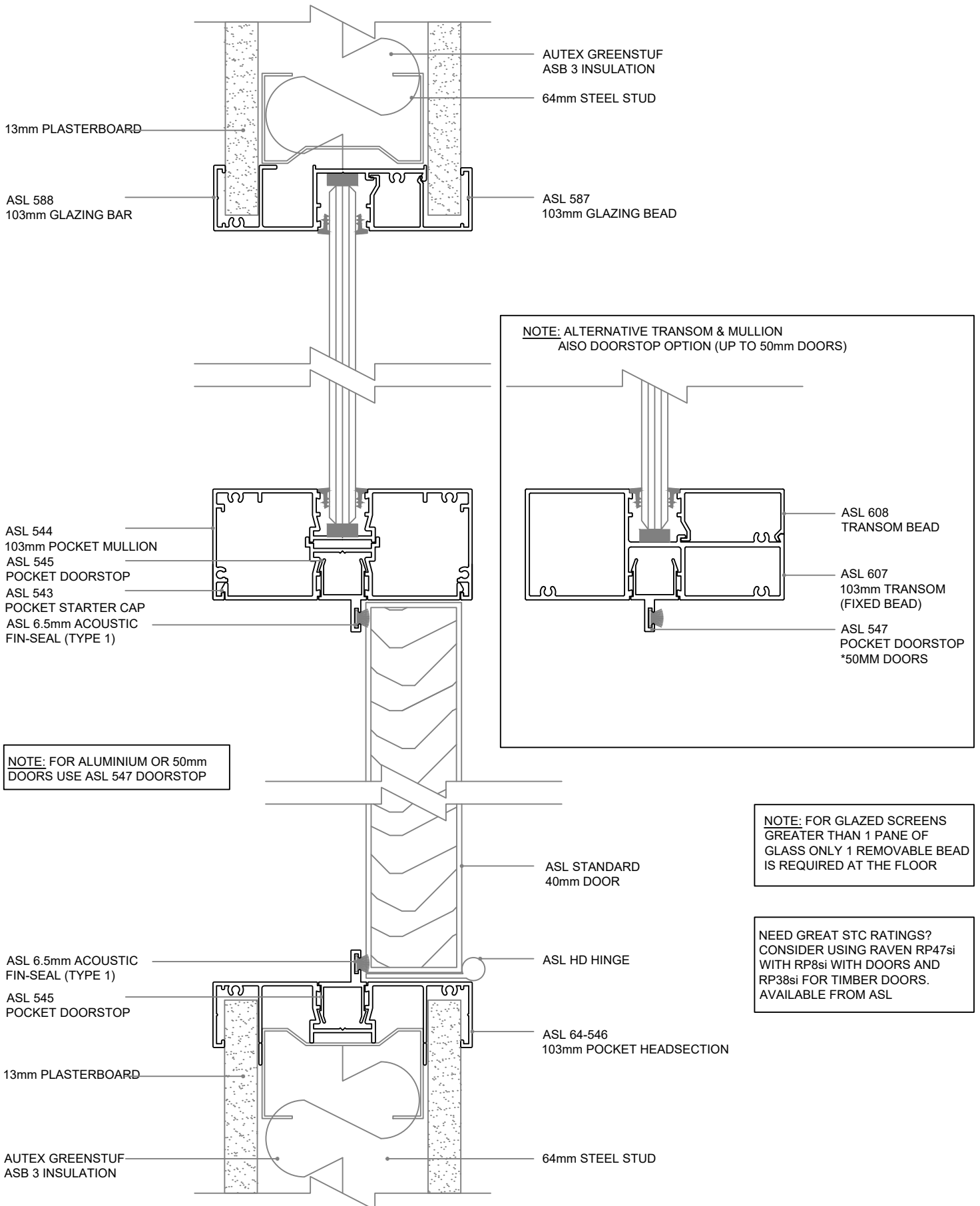

Standard Details - Door Head, Door Jamb with Negative Detail

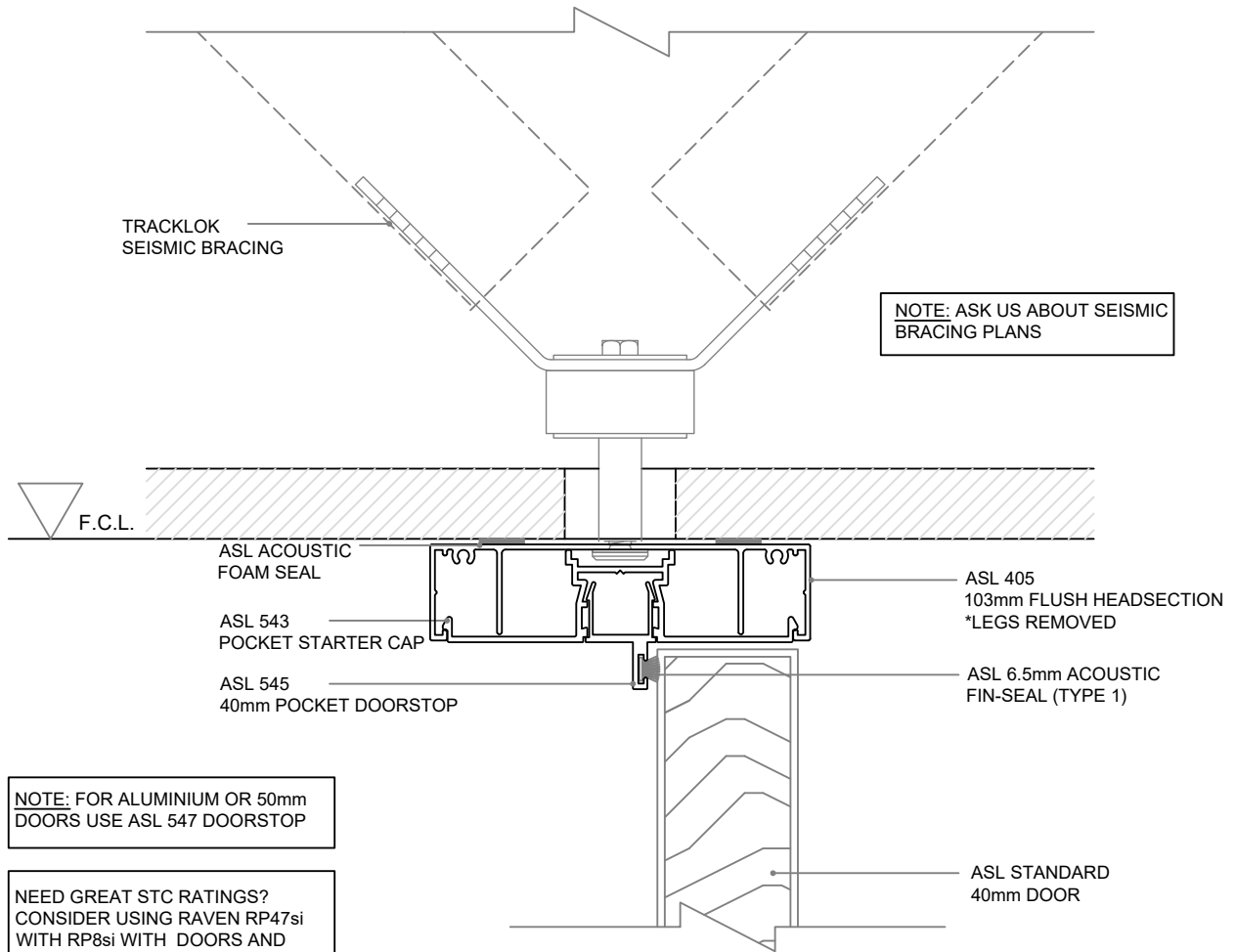

NOTE: FOR ALUMINIUM OR 50mm DOORS USE ASL 547 DOORSTOP

NEED GREAT STC RATINGS?
CONSIDER USING RAVEN RP47si WITH RP8si WITH DOORS AND RP38si FOR TIMBER DOORS. AVAILABLE FROM ASL

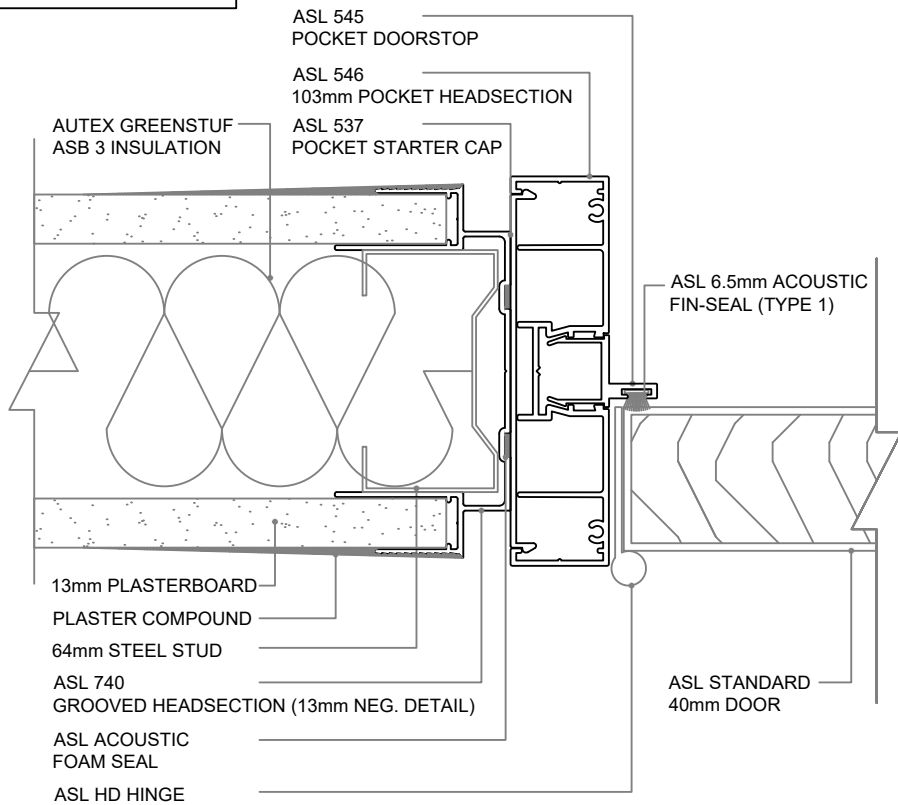

Standard Details - Deflection Headsection above Glazed Wall

