

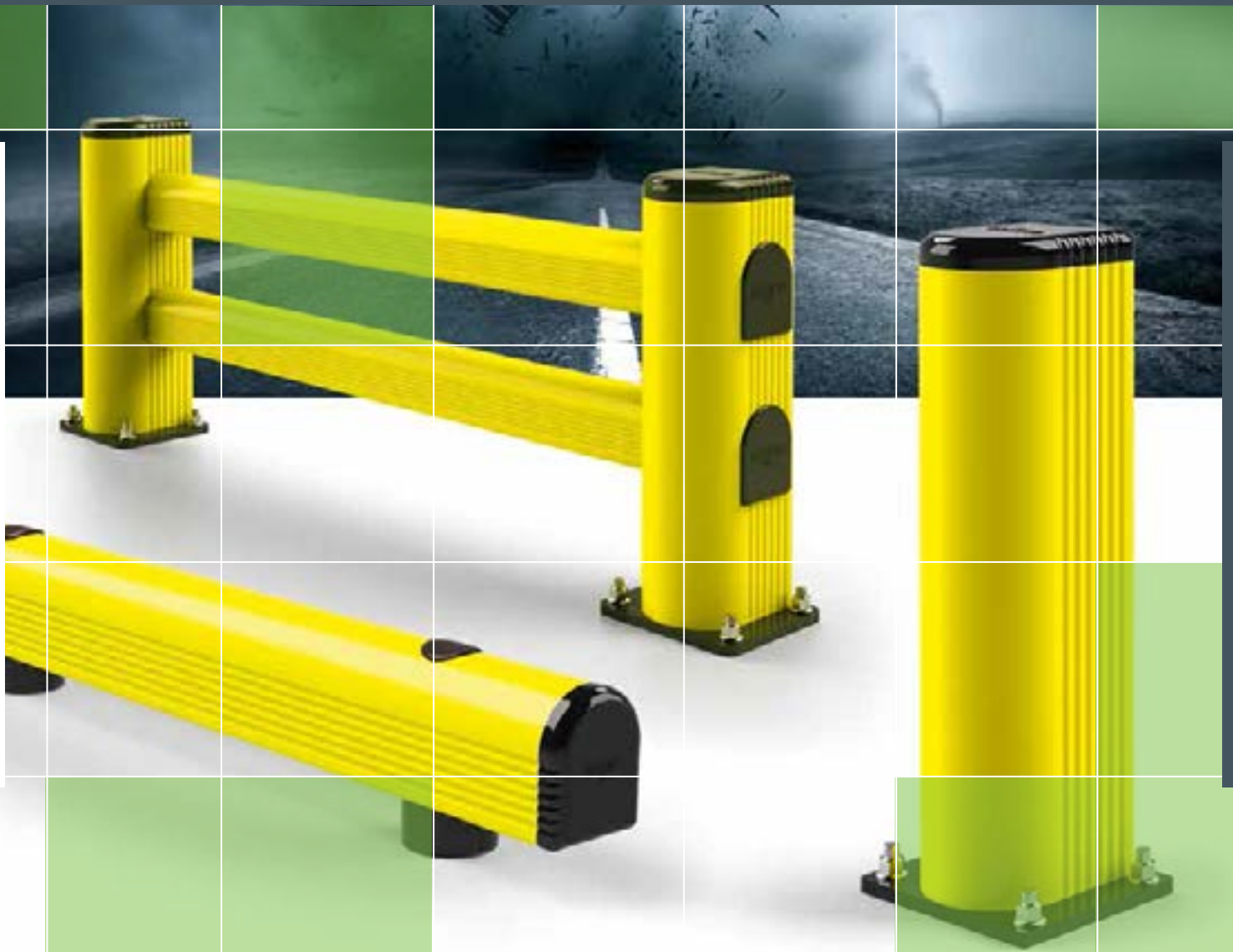

## Impactable Protection Profiles



SPECIALIST DOOR SOLUTIONS

0800 807 753

[ultigroup.co.nz](http://ultigroup.co.nz)

## ALWAYS THE BEST PROTECTION PROFILES

I.	PROTECTION PROFILES	02
II.	KERB	16
III.	WALL PROTECTION	20
IV.	ANTISHOCK SYSTEM	24
V.	PVC PANELS	26
VI.	APPENDIX: COLOURS AND CHARACTERISTICS	29



## 01: PROTECTION PROFILES



### OUR PROFILES FIT ALL RACKS

Complete range of PVC profiles to protect the warehouse racks. Equipped with accessories and shock resistant to trolleys and forklifts impacts.



# Protection Profiles

## RACK PROTECTION

EASY TO INSTALL

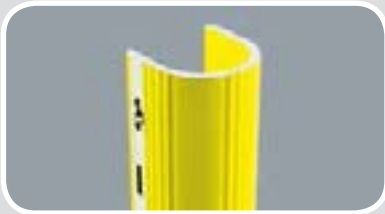

RPF 600

Equipped with accessories

60 130

FLEXIBLE

Packing: 2pcs/bag

Colour: **C**

Axle Spacing  
25 - 50 - 75 mm



RPS 600

60 80

Available size 400

ANTI SHOCK MATERIAL INSIDE

Packing: 6pcs/bag

Colour: **M**



RPM 600

80 100

Available size 400

ANTI SHOCK MATERIAL INSIDE

Packing: 4pcs/bag

Colour: **M**



RPL 600

100 120

Available size 400

ANTI SHOCK MATERIAL INSIDE

Packing: 2pcs/bag

Colour: **M**



RP CLICK

Packing: 1pc/bag









**GUARD RAIL: ROD**



EASY TO  
REMOVE AND  
REPLACE



**FIXING ACCESSORY AVAILABLE ALSO IN STAINLESS STEEL**

	<p><b>ROD PE 70 266 RE</b> Equipped with accessories Drill Ø 38</p> 	<p>Packing: 6 pcs/box Colour: <b>C</b></p>
	<p><b>ROD PE 120 433 RE</b> Equipped with accessories Drill Ø 56</p> 	<p>Packing: 1 pc/bag Colour: <b>C</b></p>
	<p><b>ROD PE 120 560 RE</b> Equipped with accessories Drill Ø 56</p> 	<p>Packing: 1 pc/bag Colour: <b>C</b></p>

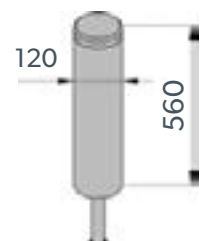
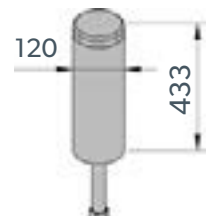
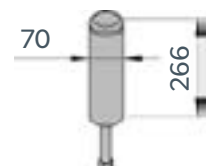

## GUARD RAIL: GRD

FAST AND  
EASY TO  
INSTALL

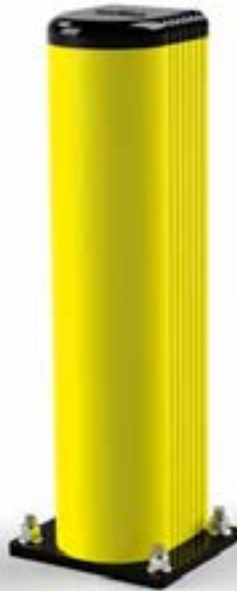

M12



GRD 90 250  
Equipped with accessories



Packing: unpacked  
on pallet

Colour: **M**



GRD 150 500  
Equipped with accessories



H 500

Packing: unpacked  
on pallet

Colour: **M**



GRD 150 800  
Equipped with accessories



H 800

Packing: unpacked  
on pallet

Colour: **M**

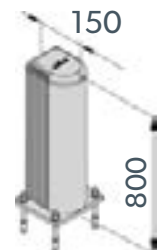

GRD 150 1100  
Equipped with accessories



H 800

Packing: unpacked  
on pallet

Colour: **M**



**GUARD RAIL: GUARD RAIL 90**

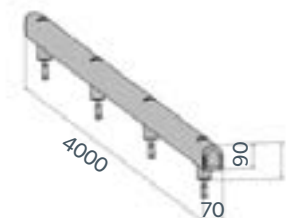
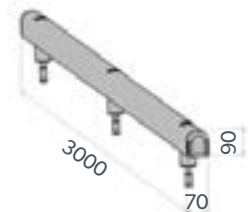
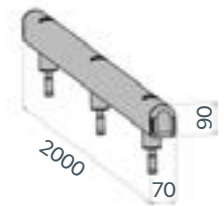
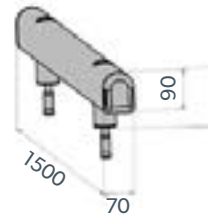
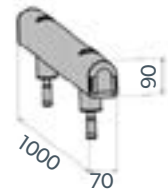
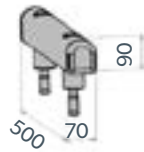
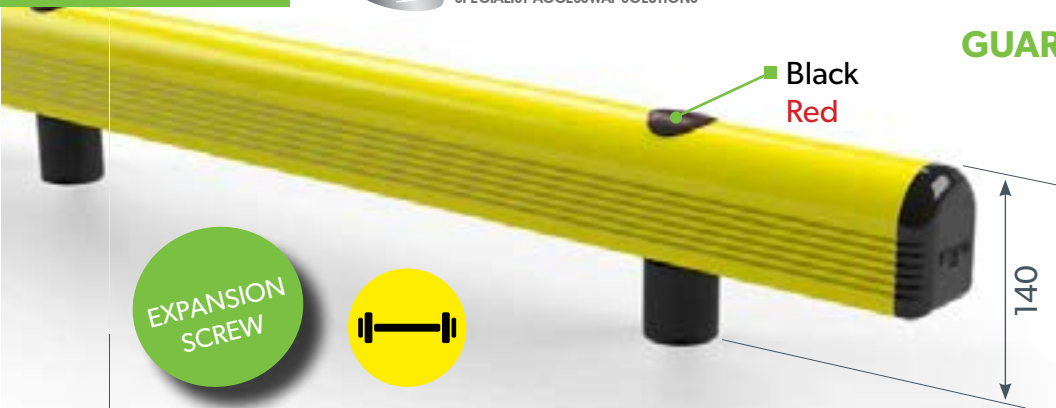

**GR 90 500**  
Equipped with accessories

Length: 500 mm  
Packing: 4 pcs/box

Colour: **M**



**GR 90 1000**  
Equipped with accessories

Length: 1000 mm  
Packing: 2 pcs/box

Colour: **M**



**GR 90 1500**  
Equipped with accessories

Length: 1500 mm  
Packing: 2 pcs/box

Colour: **M**



**GR 90 2000**  
Equipped with accessories

Length: 2000 mm  
Packing: 2 pcs/box

Colour: **M**



**GR 90 3000**  
Equipped with accessories

Length: 3000 mm  
Packing: 2 pcs/box

Colour: **M**



**GR 90 4000**  
Equipped with accessories

Length: 4000 mm  
Packing: 2 pcs/box

Colour: **M**

# Protection Profiles

## GUARD RAIL: GUARD RAIL 150



THREADED  
ROD WITH  
CHEMICAL  
ANCHOR

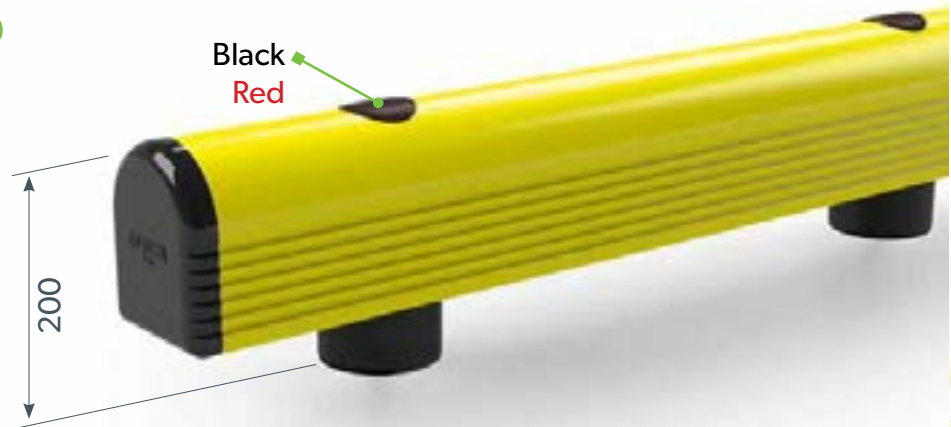

	<p><b>GR 150 500</b> Equipped with accessories</p>	<p>Length: 500 mm Packing: unpacked on pallet Colour: <b>M</b></p>
	<p><b>GR 150 1000</b> Equipped with accessories</p>	<p>Length: 1000 mm Packing: unpacked on pallet Colour: <b>M</b></p>
	<p><b>GR 150 1500</b> Equipped with accessories</p>	<p>Length: 1500 mm Packing: unpacked on pallet Colour: <b>M</b></p>
	<p><b>GR 150 2000</b> Equipped with accessories</p>	<p>Length: 2000 mm Packing: unpacked on pallet Colour: <b>M</b></p>
	<p><b>GR 150 3000</b> Equipped with accessories</p>	<p>Length: 3000 mm Packing: unpacked on pallet Colour: <b>M</b></p>
	<p><b>GR 150 4000</b> Equipped with accessories</p>	<p>Length: 4000 mm Packing: unpacked on pallet Colour: <b>M</b></p>

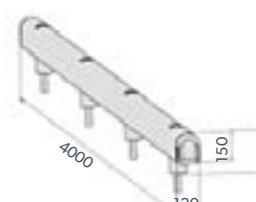
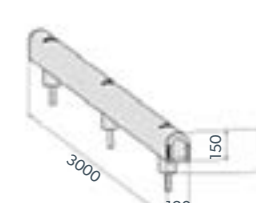
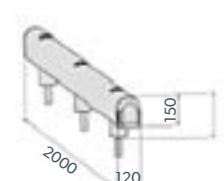
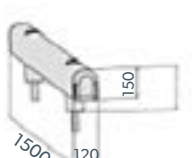
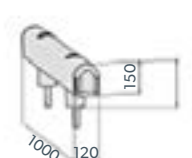
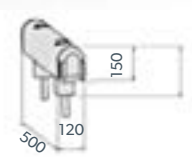



**GUARD RAIL: SM**

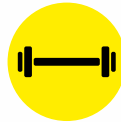

DIFFERENT SIZES ON REQUEST

FAST AND EASY TO INSTALL

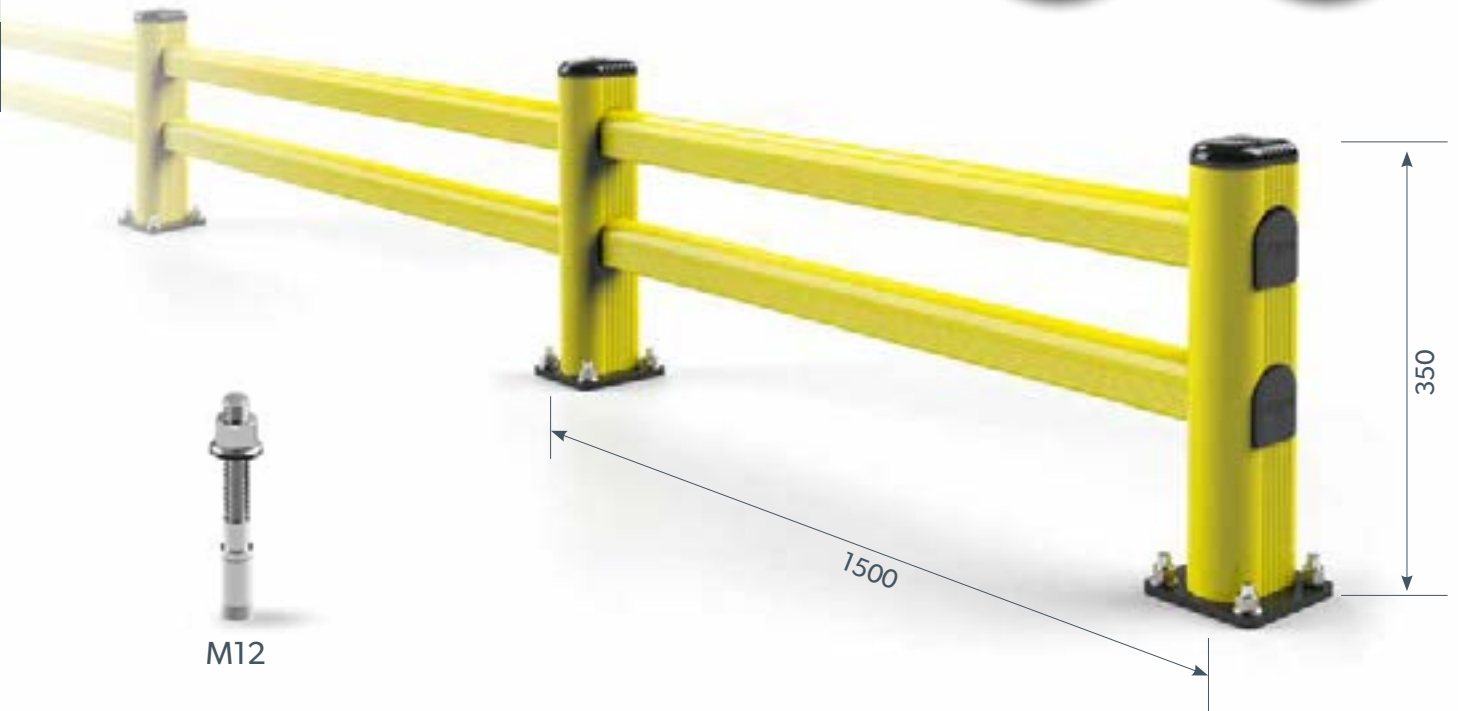

M12

	<p><b>SM 1500x400</b> <b>MODULAR</b> Equipped with accessories</p>	<p>Packing: unpacked on pallet Colour: <b>M</b></p>
	<p><b>SM 1100x400</b> Equipped with accessories</p>	<p>Length: 1100 mm Packing: unpacked on pallet Colour: <b>M</b></p>
	<p><b>SM 2400x400</b> Equipped with accessories</p>	<p>Length: 2400 mm Packing: unpacked on pallet Colour: <b>M</b></p>

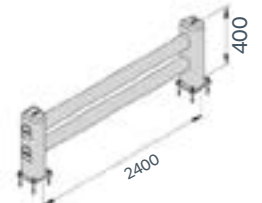
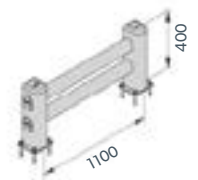
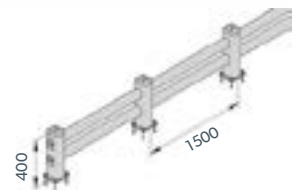

## GUARD RAIL: LM

FAST AND EASY TO INSTALL

DIFFERENT SIZES ON REQUEST



M12

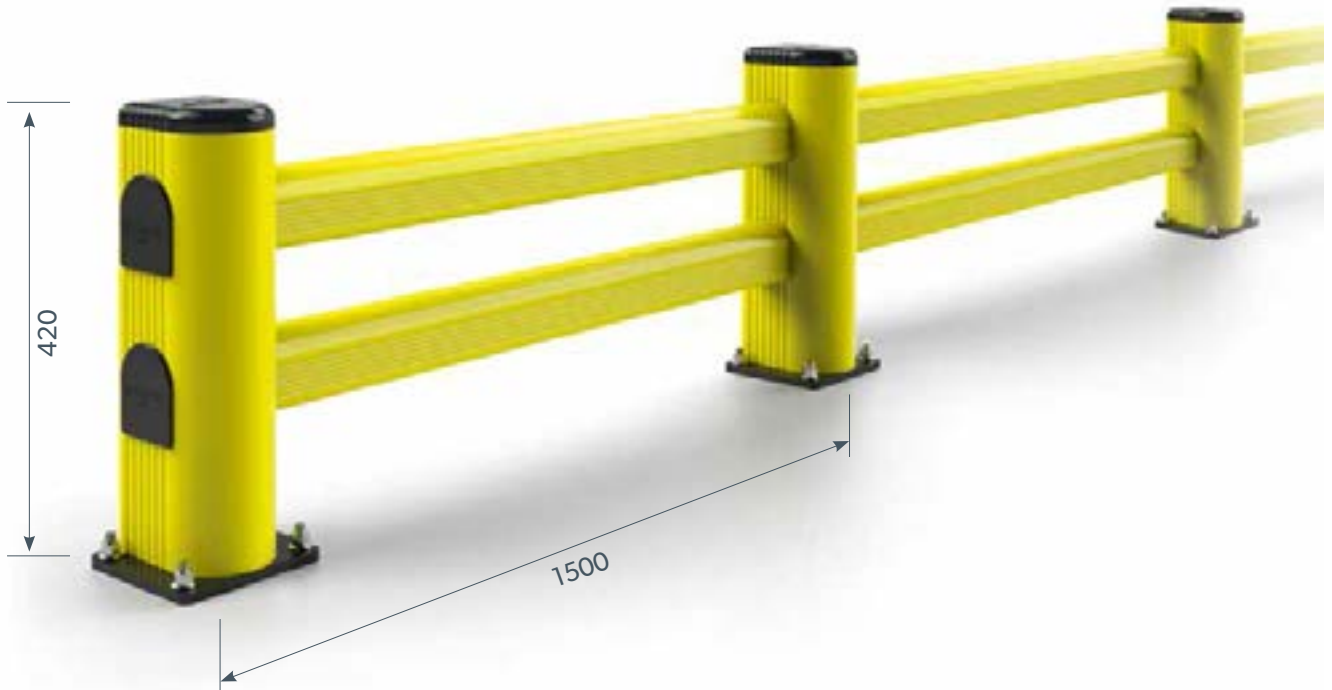

	<p><b>LM 1500x500 MODULAR</b> Equipped with accessories</p>	<p>Packing: unpacked on pallet Colour: <b>M</b></p>
	<p><b>LM 1100x500</b> Equipped with accessories</p>	<p>Length: 1100 mm Packing: unpacked on pallet Colour: <b>M</b></p>
	<p><b>LM 2400x500</b> Equipped with accessories</p>	<p>Length: 2400 mm Packing: unpacked on pallet Colour: <b>M</b></p>

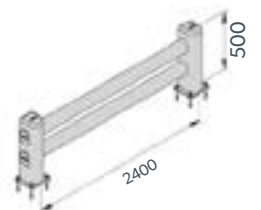
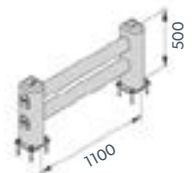
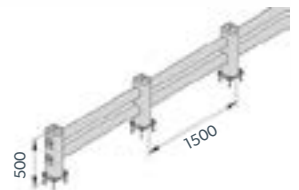

**GUARD RAIL: FENCE 90**



M12

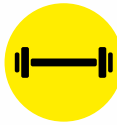

DIFFERENT SIZES ON REQUEST

FAST AND EASY TO INSTALL



**FE 1100x350**  
Equipped with accessories

Length: 1100 mm  
Packing: unpacked on pallet  
Colour: **M**

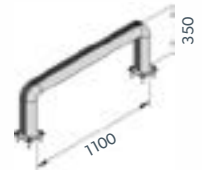

**FE 2400x350**  
Equipped with accessories

Length: 2400 mm  
Packing: unpacked on pallet  
Colour: **M**

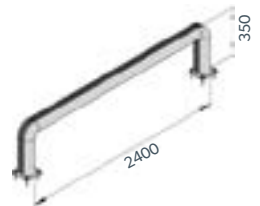

**GRA 90**

Packing: 8 pcs/box  
Colour: **B** **D**



## GUARD RAIL: LM

FAST AND EASY TO INSTALL

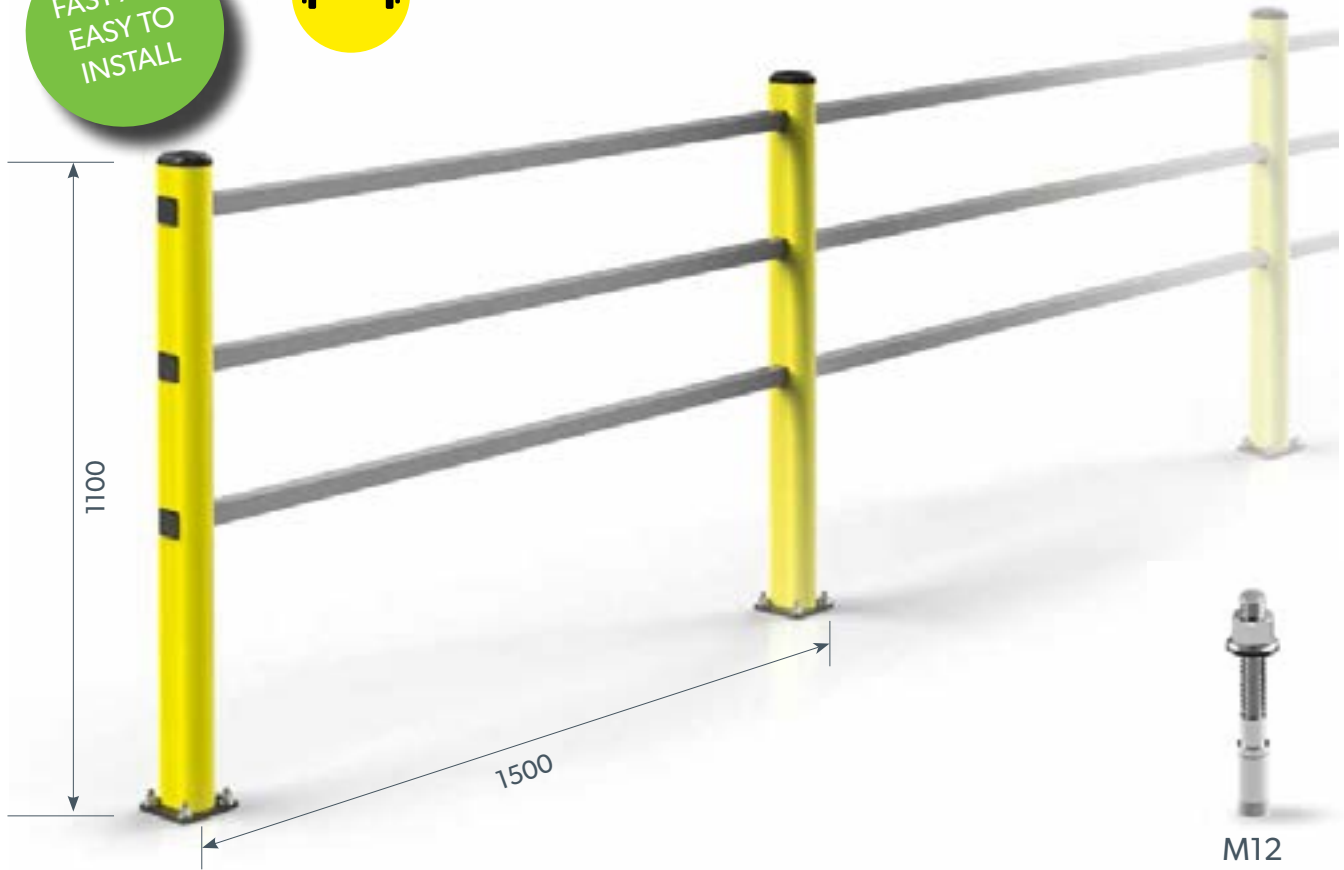

M12



HR 90 1500x1150  
MODULAR  
Equipped with accessories

Packing: unpacked on pallet

Colour: **M**



**GUARD RAIL: PEDESTRIAN 90**



FAST AND  
EASY TO  
INSTALL



M12



**PED 90 1500x1150  
MODULAR**  
Equipped with accessories

Packing: unpacked  
on pallet

Colour: **M**



## GUARD RAIL: PEDESTRIAN 150

FAST AND EASY TO INSTALL

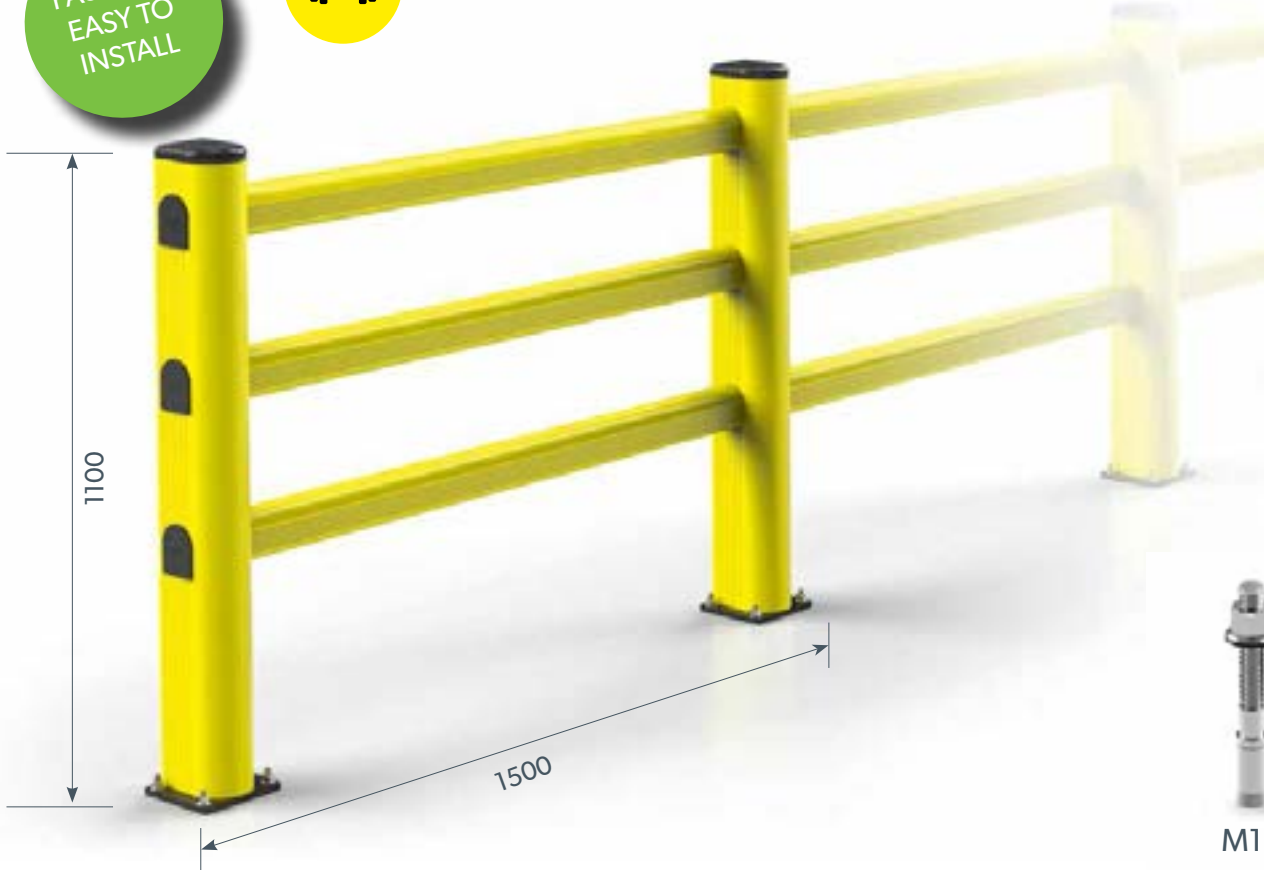

M12



**PED 150 1500x1150**  
**MODULAR**  
Equipped with accessories

Packing: unpacked on pallet

Colour: **M**

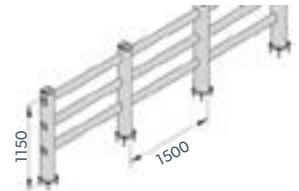

**GUARD RAIL: COLUMN PROTECTION 90**



M16

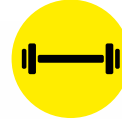

DIFFERENT  
SIZES ON  
REQUEST

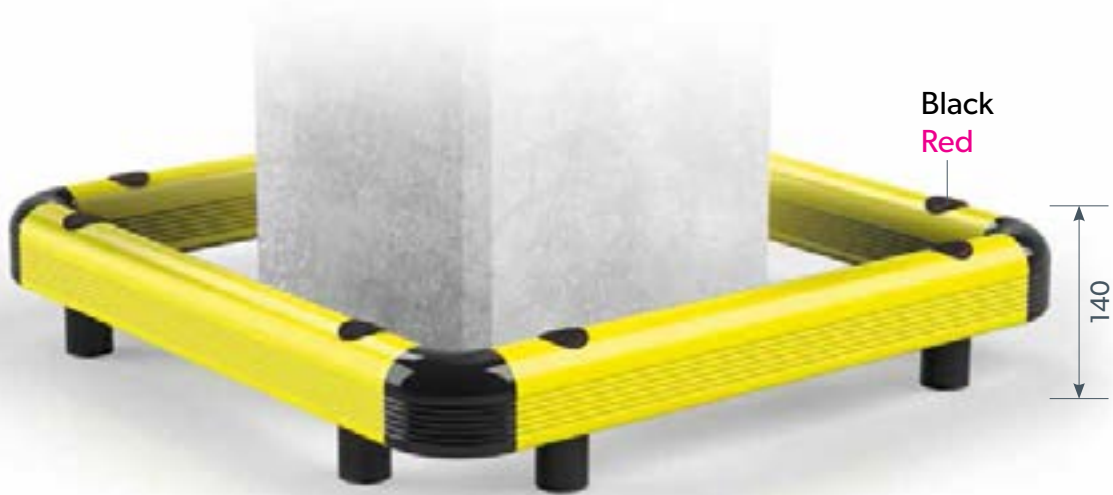

	<p><b>COPRO 500x500</b> Equipped with accessories</p>	<p>Packing: unpacked on pallet</p>	
	<p><b>COPRO 600x600</b> Equipped with accessories</p>	<p>Packing: unpacked on pallet</p>	
	<p><b>COPRO 700x700</b> Equipped with accessories</p>	<p>Packing: unpacked on pallet</p>	

## GUARD RAIL: TOWER PROTECTION

DIFFERENT SIZES ON REQUEST

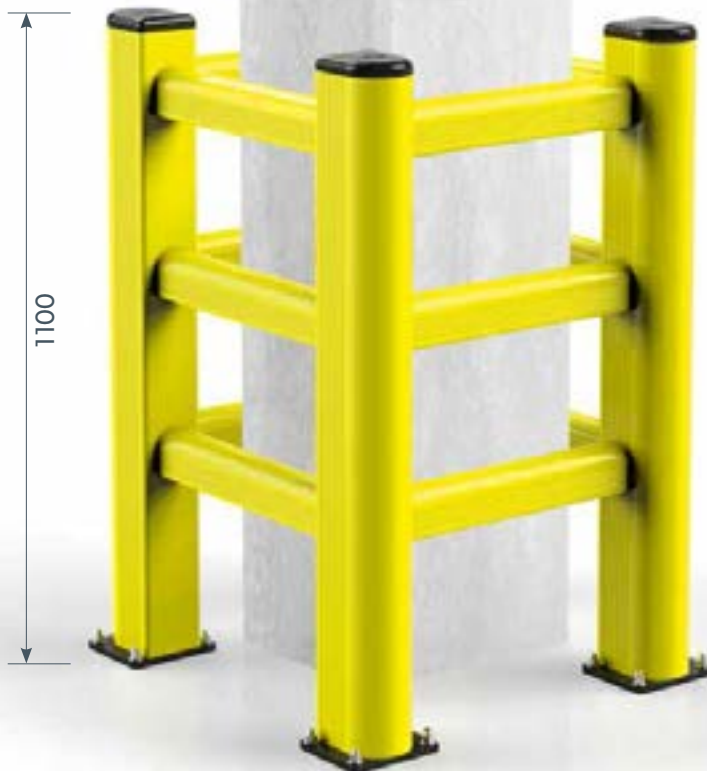

M12

	<p><b>TOWER 500x500</b> Equipped with accessories</p>	<p>Packing: to be defined</p> <p>Colour: <b>M</b></p>
	<p><b>TOWER 600x600</b> Equipped with accessories</p>	<p>Packing: to be defined</p> <p>Colour: <b>M</b></p>
	<p><b>TOWER 700x700</b> Equipped with accessories</p>	<p>Packing: to be defined</p> <p>Colour: <b>M</b></p>

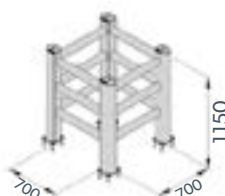
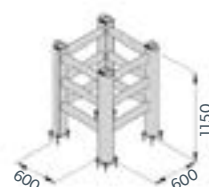
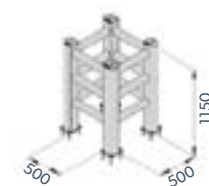



## 02: KERB



PROTECT THE FLOOR EDGES AND CORNERS OF YOUR FACILITY

## A ROBUST PROTECTION SYSTEM CREATED FOR WALLS AND PANELS

Easy to Install, clean, and comes fully equipped with corner caps and buttons.

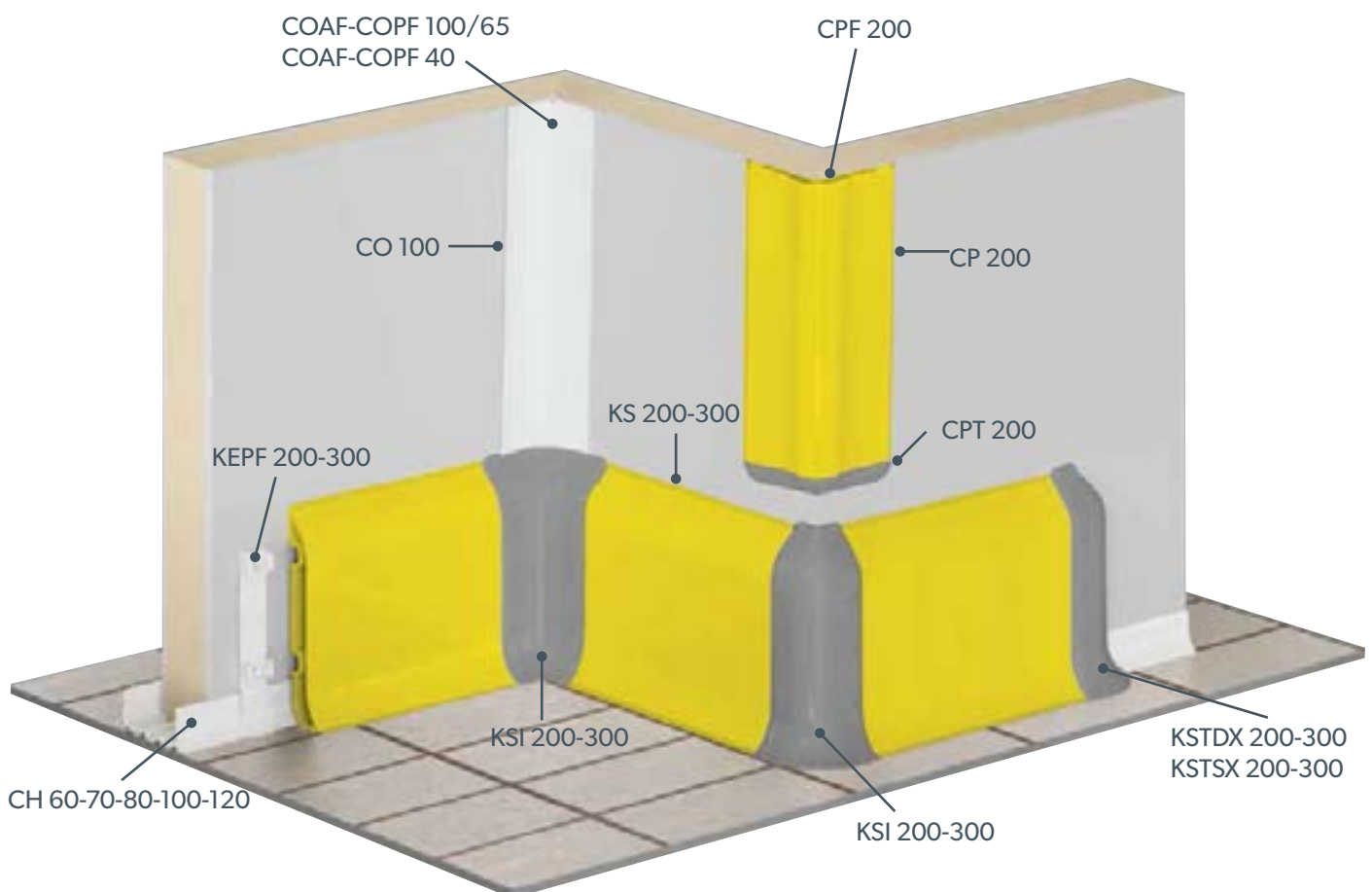



**KS 200**

Length: 4.0 m  
Packing: 3 pcs / box

Colour: **B** **M** **E**

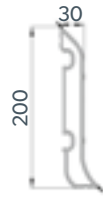

**KEPF 200**  
To install with TB14

Packing: 50 pcs / box

Colour: **K**

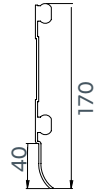

**KSJ 200**  
To install with TB14 / TF14

Packing: 20 pcs / box

Colour: **B** **E**

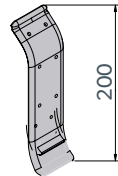

**KSI 200**  
To install with TB14 / TF14

Packing: 20 pcs / box

Colour: **B** **E**

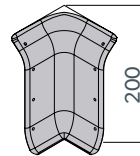

**KSE 200**  
To install with TB14 / TF14

Packing: 20 pcs / box

Colour: **B** **E**

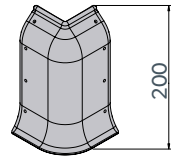

**KSTD/SX 200**  
To install with TB14 / TF14

Packing: 20 pcs / box

Colour: **B** **E**

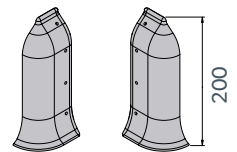

**CP 100**

Length: 4.0 m  
Packing: 10 pcs / box

Colour: **B** **M** **E** **F**



**CPF 100**

Length: 4.0 m  
Packing: 10 pcs / bag



**CPT 100**

Packing: 40 pcs / box

Colour: **B** **M** **F**



# Kerb



CP 200

Length: 4.0 m  
Packing: 2 pcs / box

Colour: **B** **M** **E**



CPF 200

Length: 4.0 m  
Packing: 2 pcs / bag



CPF 200

Packing: 20 pcs / box

Colour: **B** **E**

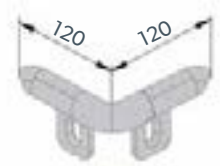

KS 300

Length: 4.0 m  
Packing: 1 pc / box

Colour: **B** **M** **E**

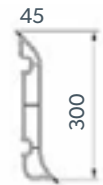

KEPF 300  
To install with TB20

Packing: 40 pcs / box

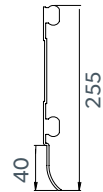

KSJ 300  
To install with TB20 / TF20

Packing: 10 pcs / box

Colour: **B** **E**

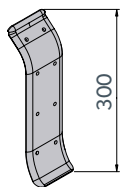

KSI 300  
To install with TB20 / TF20

Packing: 10 pcs / box

Colour: **B** **E**

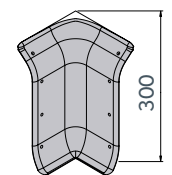

KSE 300  
To install with TB20 / TF20

Packing: 10 pcs / box

Colour: **B** **E**

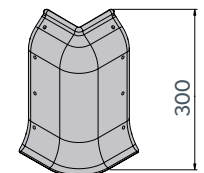

KSTD/SX 300  
To install with TB20 / TF20

Packing: 10 pcs / box

Colour: **B** **E**

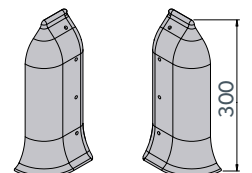

## 03: WALL PROTECTION

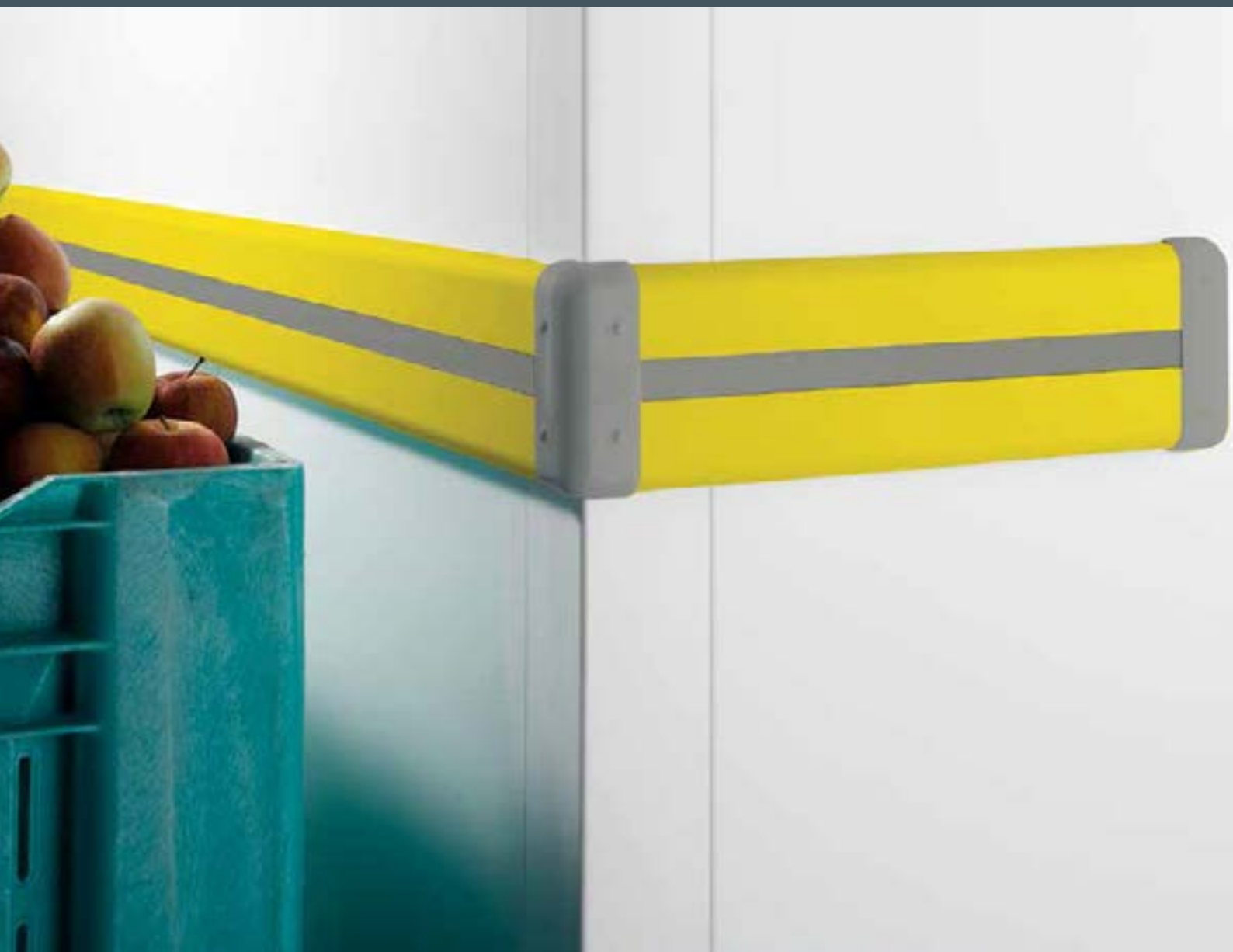

PROTECT THE WALLS AND CORNERS OF YOUR FACILITY

## OUR NEWEST BUMPERS WITHOUT GUIDES

Its large size and sturdy design provides superior protection for any facility, while its fixed caps and hidden screws behind special buttons provide a smooth surface with no protruding parts that can cause accident or injury.

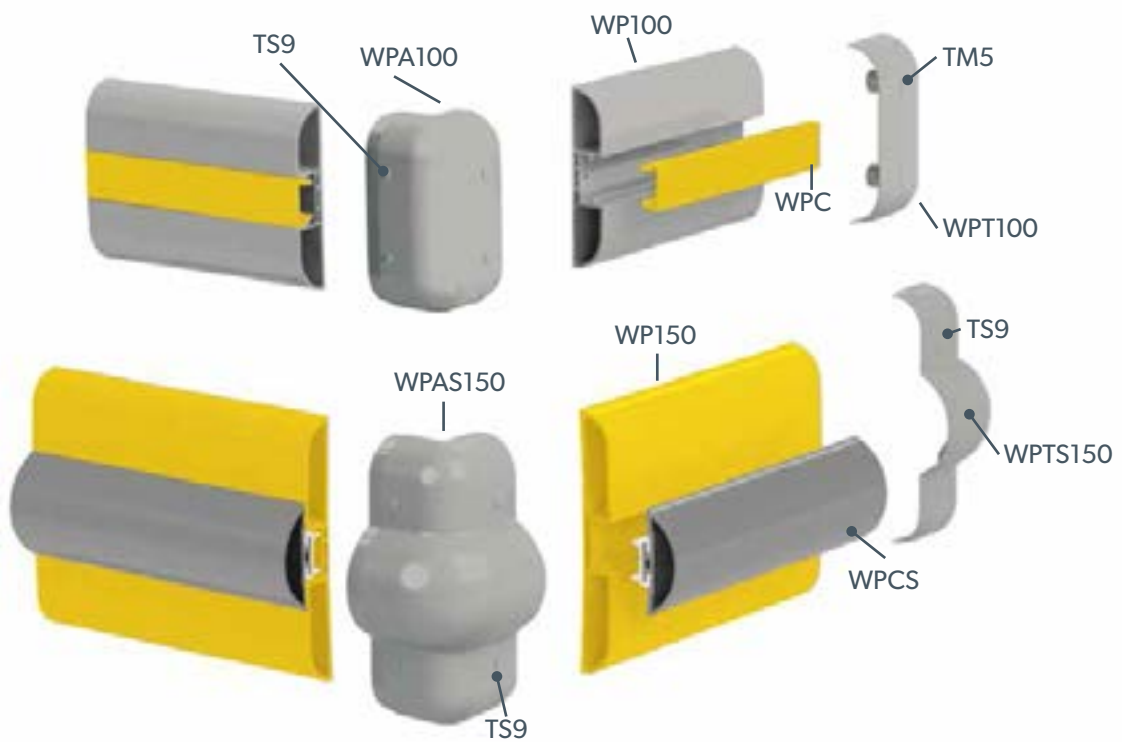

	<p><b>WP 100</b></p>	<p>Length 4.0 m Packing 8 pcs / box Colour: <b>B</b> <b>E</b> <b>F</b></p>
	<p><b>WP 150</b></p>	<p>Length 4.0 m Packing 4 pcs / box Colour: <b>B</b> <b>M</b> <b>E</b></p>
	<p><b>WPC</b> To install with WP 100/WP 150</p>	<p>Length 4.0 m Packing 16 pcs / box Colour: <b>A</b> <b>B</b> <b>M</b> <b>D</b> <b>F</b> <b>G</b> <b>H</b> <b>E</b></p>

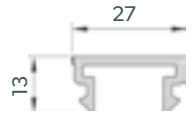
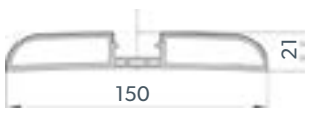



**WPT 100**  
To install with TM5

Packing: 50 pcs / box

Colour: **B** **E** **F**

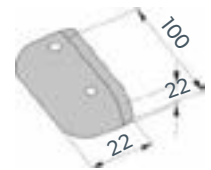

**WPA 100**  
To install with TS9

Packing: 20 pcs / box

Colour: **B** **E**



**WPT 150**  
To install with TM5

Packing: 50 pcs / box

Colour: **B** **E**



**WPA 150**  
To install with TS9

Packing: 20 pcs / box

Colour: **B** **E**



**WPCS**  
To install with WP 100/WP 150

Length: 4.0 m  
Packing: 20 pcs / box

Colour: **A** **B** **C** **D**  
**F** **G** **H** **I**  
**E**

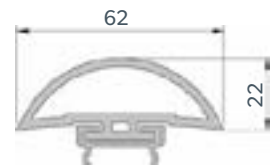

**WPTS 100**  
To install with TS9

Packing: 20 pcs / box

Colour: **B** **E**



**WPAS 100**  
To install with TS9

Packing: 20 pcs / box

Colour: **B** **E**



**WPTS 150**  
To install with TS9

Packing: 20 pcs / bag

Colour: **B** **E**



**WPAS 150**  
To install with TS9

Packing: 20 pcs / box

Colour: **B** **E**



## 04: ANTI-SHOCK SYSTEM



PROTECT YOUR FACILITY'S COLD STORAGE ROOMS  
FROM SUDDEN IMPACT



## OUR LATEST BUMPER AND PLINTH SYSTEM

Made of soft material, our anti-shock system is used in cold rooms, refrigerated storages and garages. It features good anti-shock capabilities thanks to the material elasticity.

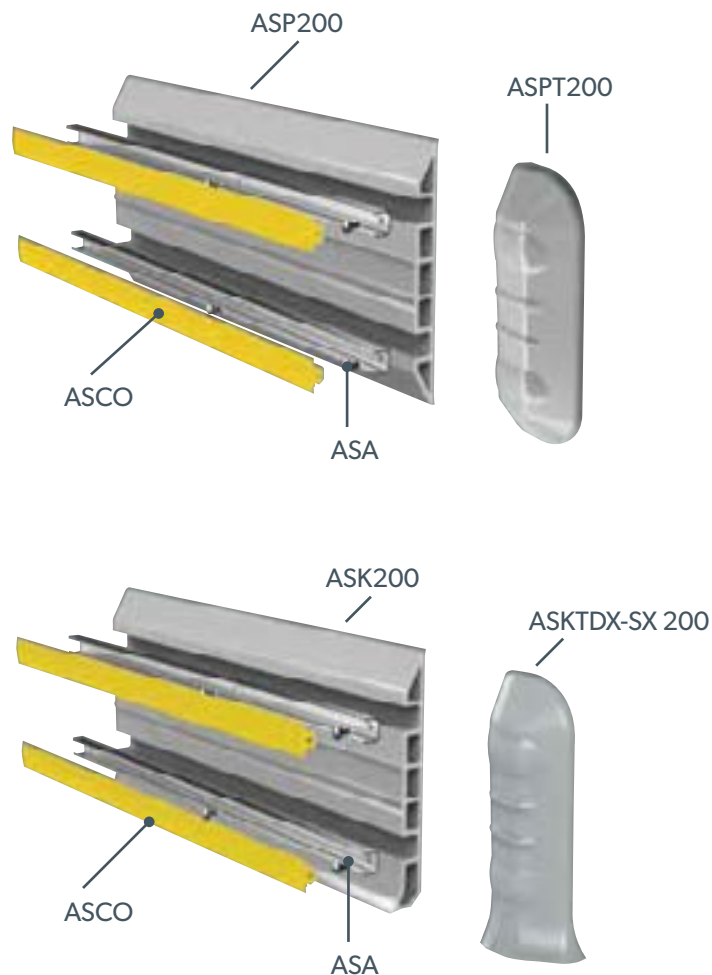

# Anti-Shock System



ASK 200



Length: 4.0 m  
Packing: 4 pcs / box

Colour: **B** **C**



ASK2I200



Packing: to be defined

Colour: **B**



CPF 200



Packing: to be defined

Colour: **B**

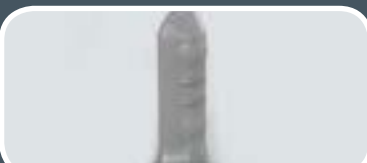
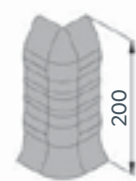

KS 300



Packing: to be defined

Colour: **B**

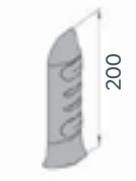

KEPF 300



Length: 4.0 m  
Packing: 4 pcs / box

Colour: **B** **C**



KSJ 300



Packing: 10 pcs / box

Colour: **B** **D**

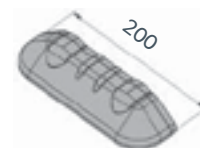

KSI 300

Material: aluminium  
Length: 4.0 m  
Packing: 8 pcs / bundle



KSE 300



Packing: 2 pcs / box  
Length: 3.2 m

Colour: **A** **B** **C** **D**  
**G**











## 05: PVC PANELS



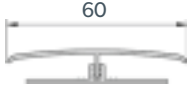



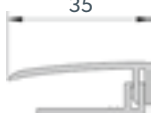

**RENOVATE YOUR COLD STORAGE ROOMS - QUICKLY  
AND AT A FRACTION OF THE PRICE**

# Anti-Shock System

	<p><b>PF 300</b> Foamed Internals</p> <p>DIFFERENT SIZES ON REQUEST</p>	<p>Length: 4.0 m Packing: 3 pcs / bag</p> <p>Colour: <b>E</b></p>	
	<p><b>PR 300</b></p> <p>DIFFERENT SIZES ON REQUEST</p>	<p>Length: 4.0 m Packing: 3 pcs / bag</p> <p>Colour: <b>E</b></p>	
	<p><b>PJ</b> Installed with PR 300 and PF 300</p> <p>DIFFERENT SIZES ON REQUEST</p>	<p>Length: 3.0 m Packing: 10 pcs / box</p> <p>Colour: <b>E</b></p>	
	<p><b>PA</b> Installed with PR 300 and PF 300</p> <p>DIFFERENT SIZES ON REQUEST</p>	<p>Length: 3.0 m Packing: 10 pcs / box</p> <p>Colour: <b>E</b></p>	
	<p><b>PT</b> Installed with PR 300 and PF 300</p> <p>DIFFERENT SIZES ON REQUEST</p>	<p>Length: 3.0 m Packing: 10 pcs / box</p> <p>Colour: <b>E</b></p>	

## ACCESSORIES

	<p><b>TM5</b> Hole required <math>\varnothing</math> 8.5 Neutral polyethylene 100 or 500 pcs/bag</p>		<p><b>TB20</b> Hole required <math>\varnothing</math> 5 Steel/aluminium 500 pcs/box</p>
	<p><b>TS9</b> Hole required <math>\varnothing</math> 5 White or grey nylon 250 pcs/bag</p>		<p><b>TF14</b> Hole required <math>\varnothing</math> 5 Aluminium 500 pcs/box</p>
	<p><b>TB14</b> Hole required <math>\varnothing</math> 4 Steel/aluminium, white 500 pcs/box</p>		<p><b>TF20</b> Hole required <math>\varnothing</math> 6.5 Aluminium 500 pcs/box</p>

## 06: APPENDIX

### COLOURS

											
<b>A</b>	<b>B</b>	<b>C</b>	<b>D</b>	<b>E</b>	<b>F</b>	<b>G</b>	<b>H</b>	<b>I</b>	<b>K</b>	<b>L</b>	<b>M</b>
RED RAL 3002	GREY RAL 7040	YELLOW RAL 1023	BLACK RAL 9005	WHITE RAL 9010	WHITE RAL 9002	BLUE RAL 5005	GREEN RAL 6029	SILVER RAL 9006	LIGHT GREY RAL 7035	DARK GREY RAL 7024	LIGHT YELLOW RAL 1018

### SYMBOLS



Cleaner Resistant



Quick Assembly



Shockproof



Cost Effective



Long Resistance



Waterproof



Easy to Clean



Thermal Insulation



Non-toxic



Class V0 Self-extinguishing Fire Resistance



AVAILABLE



NOT  
AVAILABLE



[www.ultigroup.co.nz](http://www.ultigroup.co.nz)



SPECIALIST  
**ACCESSWAY**  
SOLUTIONS



0800 807 753 | +64 9 407 9619 | [sales@ultigroup.co.nz](mailto:sales@ultigroup.co.nz)

Northland, Auckland, Waikato, Bay of Plenty, Taranaki, Manawatu, Wellington, Marlborough, Nelson, Christchurch