

XXX

11.2020

# Sanifast



EN Grey water pump • Operating/installation manual



## 1. SAFETY



**DISCONNECT ELECTRICAL POWER BEFORE WORKING ON THE PUMP !**

Plumbers/Contractors, please ensure a copy of the installation instructions is left with the end user for future reference.

## 2. RECOMMEND USE

The **Sanifast** is a compact grey water lifting station designed for light - medium commercial use. The unit is designed to receive and pump away waste water from a washing machine, kitchen sink, dishwasher, bath, shower or basin.

### NOTICE



- DO NOT dispose of solvents, paints, turps, caustic acid, or other corrosive acids or cleaners.
- DO NOT dispose of hot water in excess of 75°C.
- DO NOT use cleaning products that produce excessive foam, this may cause motor damage.
- DO NOT install in a hairdressing salon without the use of a hair trap first.
- DO NOT dispose excessive amount of coffee grinds.
- DO dispose of grey waste water ONLY.

## 3. DESCRIPTION

### 3.1 TECHNICAL DATA

<b>Product Code and Description</b>	ZH190 Commercial Grey Water Lifting Station	<b>Inlets</b>	2
<b>Electrical Power Supply</b>	220 - 240 V 50 Hz	<b>Inlet Diameter</b>	50 mm
<b>Nominal Current</b>	3.7 A	<b>Recommended Waster Water pipe</b>	DN32
<b>Motor Power Rating</b>	850 W	<b>Venting</b>	Optional external vent connection
<b>Vertical Pumping Height</b>	Up to 7 meters	<b>Alarm</b>	Included
<b>Horizontal Pumping Distance</b>	Up to 100 meters	<b>Casing</b>	White
<b>Maximum Temperature</b>	40-75°C (Short period)	<b>Dimensions</b>	395 x 233 x 389 mm (W x H x D)

### 3.2 FLOW CHARACTERISTICS

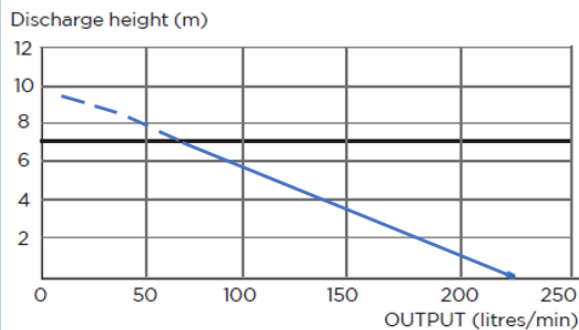

### 3.3 PUMPING DISTANCE PERFORMANCE

Increase size of horizontal run by one pipe size after 5m. All horizontal pipework requires a minimum of 1:100 fall.

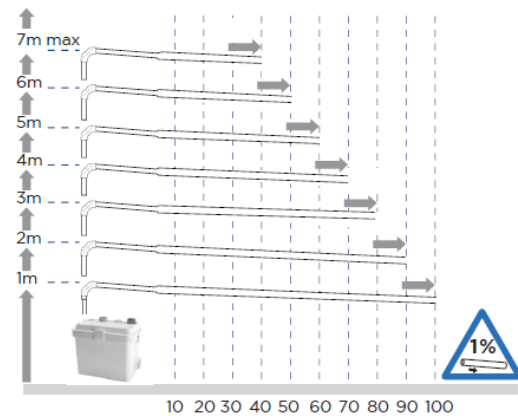

#### NOTE

1% fall minimum required on the horizontal run.

Pipe size must be increased by 1 size minimum after the first 5 meters of horizontal run.

### 3.4 DIMENSIONS

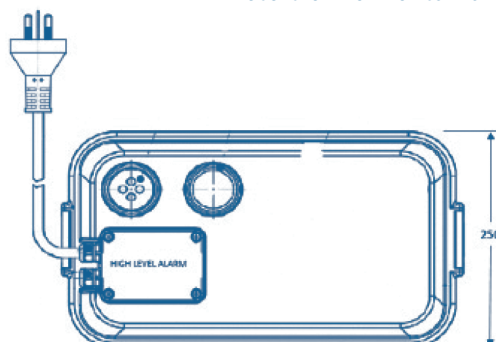
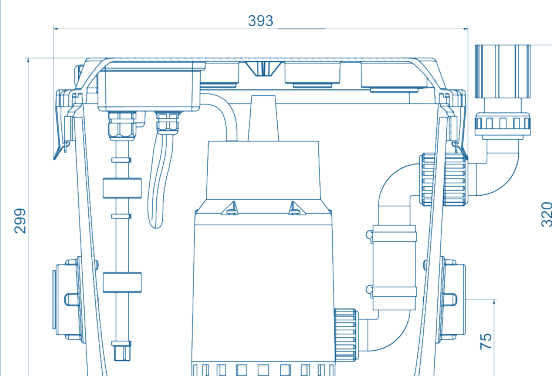

## 4. INSTALLATION

- The lifting station should be installed to allow full access in the event that servicing or removal is required.
- The unit must be located on the same floor as the fittings it is to service.
- All incoming pipework must have a constant gradient of 1:40.
- The unit has 2 inlet ports. If an inlet is not in use, cap off the inlet with side plug (#7).
- Lid has optional external vent connection point.
- Where possible, venting should always be consistent to current plumbing venting requirements as per AS 3500.
- Before commissioning the unit, make sure all connections are secure and water tight.
- The electrical installation should be carried out by a registered electrician in accordance with AS/NZS 3000.
- AAV valves are not an alternative to venting to atmosphere as the unit needs to have two way venting for correct activation function.

### 4.1 CONNECTING INCOMING WASTE WATER

1. Use the lower inlets for incoming waste connection (Fig 2) supplied PVC adaptor pushes into connection point allowing 50 mm pipe to be glued. Make sure waste line is run at a gradient of 1:40.
2. Fixtures must be trapped prior to the pump as per the plumbing code.
3. If an external vent to atmosphere is required, the optional connection point on the lid in (Fig 1) can be utilised.

### 4.2 CONNECTING OUTGOING (DISCHARGE) WASTE WATER

#### NOTE

Vertical lift (only 1 vertical lift allowed) must occur prior to any horizontal runs except for the initial short run at the pump connection; this should be no more than 300 mm in length.

1. Connect to the 32 mm female threaded collar with a short thread adaptor so as not to hinder the opening and closing of the non-return valve flap assembly (inset Fig 3) from there make sure to use 32mm UPVC pressure pipe to commence your vertical lift.
2. A UPVC pressure ball valve must be install as close to the pump as possible (Fig 2).

#### NOTE

45-degree bends must be used to achieve all changes of direction, pipe size must be increased to 40mm after the first 5 metres on the horizontal run (see §3.3), failure to do so may void warranty.

FIG 1

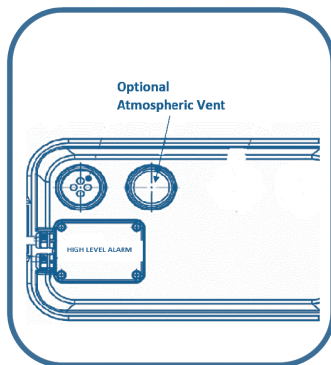

FIG 2

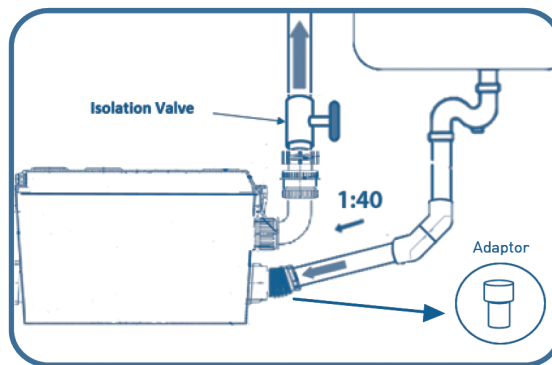
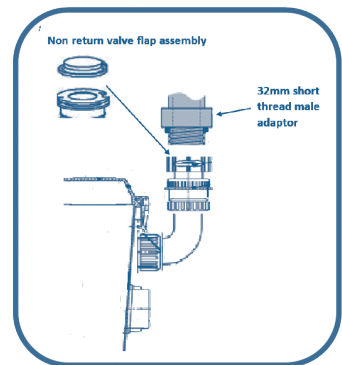

FIG 3



### 4.3 HIGH LEVEL CONTROL SANIALARM INTERLOCK CONNECTION (OPTIONAL)

FIG 1 shows Sanialarm Interlock has a socket connection marked «Quick plug float switch». Plug one end of supplied accessory lead to this connection, as indicated. Plug the other end of supplied lead to connection indicated on the pump (FIG 2). Finish connecting Sanialarm Interlock as per instructions supplied with alarm.

FIG 1

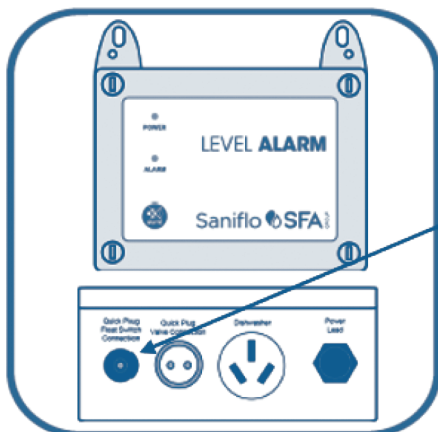
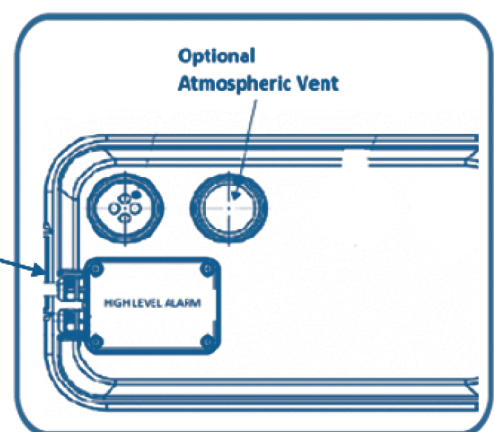

FIG 2



## 5. COMMISSIONING

- Once ALL connections are secure and before you switch the power on, run the cold water tap for short period and allow water to enter the pump.
- Then switch the power to the pump ON. Your pump should immediately activate and begin discharging into the discharge pipe system. Initial run time is normally between 5-10 seconds. Duration of run time is generally determined by the length of travel in the pump-out line.
- Pump operation will shut down after this time.
- Check that the connections with the sanitary devices connected to the pump do not leak.

## 6. MAINTENANCE



**DISCONNECT ELECTRICAL POWER BEFORE WORKING ON THE PUMP !**

### NOTICE



In case of prolonged absence, it is imperative to cut off the general water supply and to protect the installation against frost.

**DO periodically clean the lifting station with a quality cleaning product on the market that is not acid/citric based.**

## 7. TROUBLESHOOTING

SYMPTOMS	PROBABLE CAUSES	REMEDIES
The unit stops.	Impeller is jammed.	Contact service/installation support.
	The unit has been running for too long and the (self re-setting) thermal cut out has been engaged.	The unit will reset itself.
The motor intermittently activates.	Dripping tap/fixtures.	Check the installation upstream.
	The non-return valve is faulty.	Clean or replace the non-return valve (externally mounted)
The motor operates normally, but continues to run for a long time.	The length or height of the installation is over the specification, or there are too many bends/elbows.	Check the installation Contact service/installation support.
	The pump intake chamber is blocked.	
	An electrical component has failed.	
The motor does not activate.	The electrical power supply is not active.	Restore the electrical supply.
	The motor or the control system is defective.	Contact service/installation support.
The motor hums but does not run.	The motor or the control system is defective.	Contact service/installation support.

## 8. WARRANTY

### 2 YEAR WARRANTY

This device is guaranteed for 2 years from the date of purchase and is subject to ACL (2) 2010 and NZ CG Act 1993 if used for personal, domestic and household use.

Installation in strict compliance with manufacturers installation.

Read more at [pro.saniflo.co.nz/cms/47/warrantyconditions](http://pro.saniflo.co.nz/cms/47/warrantyconditions).

### WARRANTY CONDITIONS

This warranty will apply only under all of the following conditions:

- The item has been installed by a licensed plumber
- Failure is due to a fault in the manufacture of the product
- Proof of purchase (including the date of purchase) is provided
- The installation of the product is in accordance with the instructions provided.