

Installation Manual (Undertile Heating Kit)

Technical Helpline
0800 927 687



IMPORTANT
Please read the
ENTIRE Installation
Manual before
attempting to
install your
undertile heater.
Incorrect
installation could
damage the cable
and invalidate your
warranty.

Contents

- 2 Safety net guarantee
- 3 Sizing guide
- 4 Calculate the actual spacing of the heating element
- 5 Technical notes
- 6 Subfloor Preparation
- 8 Wiring Configuration
- 9 Electrical Requirements
- 10 Simple steps to luxurious warmth
- 12 Installation steps 1 & 2
- 13 Installation steps 3 & 4
- 14 Installation steps 5 & 6
- 16 Installation step 7
- 17 Installation steps 8 & 9
- 18 Do's and don'ts

Your Warmup Undertile Heater has been designed so that installation is quick and straight forward, but as with all electrical systems, certain procedures must be strictly followed. Please check the sizing guide to ensure that you have the correct heater for the area you wish to heat.



Kit contents

- Undertile Heating Element
- Adhesive spray
- UT tape
- Watchdog Continuity alarm
- Installation Manual

Note: Floor sensing thermostat not included (to be ordered separately)

Warmup New Zealand Ltd accepts no liability, expressed or implied for any loss or consequential damage suffered as a result of installations which in any way contravene the instructions that follow.

If you encounter any problems or questions during your installation, please feel free to call the Warmup helpline for your local agent.

Warmup helpline: 0800 927 687

To ensure a trouble free installation be sure to read the list of “Do's and don'ts” at the end of this booklet.

We strongly recommend you use Warmup insulation board as your tile backer board. For more information, please call the Warmup helpline.

WARMUP SAFETY NET GUARANTEE



General information about your warranty:

- When you buy a Warmup DIY undertile heater to install yourself, and you make a mistake and cut or damage your new Warmup heater before tiling, you can bring it back to us and Warmup will replace the heater for you, except where the exclusions listed below apply.
- You will need to provide us with proof of your purchase to be able to take advantage of our Safety Net Guarantee, so it is important that you keep written proof of your purchase.
- Nothing in this Safety Net Guarantee is intended to affect your rights under the Consumer Guarantees Act or any other law in New Zealand extending any product warranties or protections to you.
- You must bring your damaged Warmup heater, together with your original dated sales receipt, back to us within 30 days of the date you purchased it.
- If you cut or damage your DIY heater during tiling, contact Warmup immediately to arrange a site visit. Warmup will attempt to repair the damaged heater. This visit along with any subsequent visits for repairs to heaters on partially or fully tiled floors may incur a call out charge at Warmup's discretion.
- Repaired heaters carry a five year warranty only.

This Safety Net Guarantee applies only if:

- ◆ Your heater is a genuine Warmup DIY heater.
- ◆ You bring the heater back to us within 30 days of the date you purchased it.
- ◆ You provide us with written and dated proof of your purchase.
- ◆ The floor covering has not been installed over the heater.

Warmup is not responsible for:

- Damage done or repairs required as a consequence of the faulty installation or application of your heater.
- Damage done as a result of environmental factors affecting your heater which are beyond Warmup's control.
- Use of components or accessories which are not compatible with your heater.
- Heating units installed outside New Zealand.
- Normal maintenance which is described in our installation and operating manual.
- Parts not supplied or specified by Warmup.
- Damage done or repairs required as a result of any improper use, maintenance, operation or servicing of your heater.
- Failure to start due to interruption of or inadequate electrical supply.
- Changes in the appearance of your heater or accessories that do not affect their performance.
- Incidental or consequential damage of any kind, including but not limited to costs or expenses resulting from damage to any property.



Underfloor heating | Tiled shower solutions

Freephone: 0800 927 687 Website: www.warmup.co.nz Email: info@warmup.co.nz

Sizing guide

For larger or different area sizing - please contact 0800 WARMUP (927-687) for your local Distributor.

Element	Total Ohms (@ 20 °C)	Cable Length	Coverage in sqm (at wire centers of ± 10% (mm))			Power Density (watts per sqm) ± 5%		
			60	85	100	60	85	100
UT200	264 ohms	16.5m	0.90	1.22	1.42	222	163	140
UT300	176 ohms	25.0m	1.29	1.79	2.09	232	167	144
UT400	132 ohms	33.5m	1.76	2.45	2.86	227	163	140
UT500	105 ohms	41.5m	2.18	3.06	3.57	229	164	140
UT650	82 ohms	54.0m	2.91	4.07	4.76	223	159	136
UT800	66 ohms	66.5m	3.60	5.06	5.91	223	159	136
UT1000	52 ohms	83.5m	4.56	6.41	7.50	219	156	133
UT1250	42 ohms	105.0m	5.82	8.18	9.58	216	154	132
UT1500	33 ohms	125.0m	6.96	9.79	11.47	215	153	131
UT1800	29 ohms	150.0m	8.38	11.59	13.46	215	155	134
UT2000	25 ohms	166.5m	9.37	13.19	15.46	211	150	128
UT2500	21 ohms	208.5m	11.85	16.69	19.56	214	152	129
UT3000	16 ohms	250.0m	14.31	20.14	23.61	210	149	127

Notes:

These are nominal specifications only.

Coverage table is by calculation only - actual wire layout on the floor may have an effect on the actual coverage obtained. The table shows the area in sqm that any cable will cover at various wire centres, e.g. if a UT1000 is laid up with the runs 85mm apart, a total heated area of 6.41sqm should be achieved.

The power density table shows the watts per sqm of the heated area - the higher the power density the greater the temperature rise on the tiled surface.

The table below gives the maximum and minimum wire spacing between the runs of the heating element.

Type of flooring	No less than(mm)	No greater than(mm)
Timber	50mm	100mm
Concrete	50mm	75mm
If using Warmup insulation board with timber or concrete	50mm	100mm

Calculate the actual spacing of the heating element

1. Work out the actual sqm to be heated (see grey shaded area) i.e. **3.53sqm.**

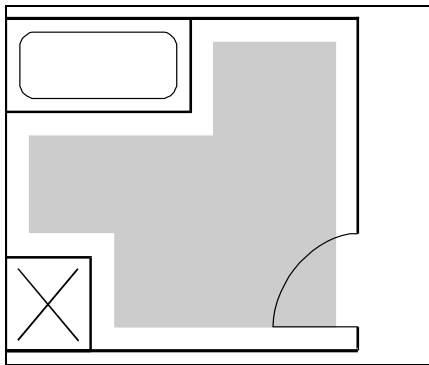

2. Divide this figure by the length of the wire to be used per the sizing guide -
 $3.53\text{m}^2 \div 41.5\text{m} = \mathbf{0.085}$.
3. Multiply this figure by 1000. $0.085 \times 1000 = \mathbf{85\text{mm}}$ apart is your wire spacing.

Summary:

$$\frac{3.53\text{m}^2}{41.5\text{m of wire}}$$

$$= 0.085 \times 1000 = 85\text{mm apart}$$

Helpful Hints

- The element is a continuous wire that must not be shortened or lengthened. Even spacing of the wire will ensure an even temperature of your tiles.
- The adhesive spray ensures that the adhesive tape holds in place. Allow 10 minutes for curing before attempting to adhere tape.
- All the elements are marked with a halfway marker for an indication of how your installation is progressing.
- For a successful long installation life, your floor should be clean, dry and stable (wooden floors) or fully cured (concrete floors).
- The table below gives the maximum and minimum wire spacing between the runs of the heating element.

Type of flooring	No less than (mm)	No greater than(mm)
Timber	50mm	100mm
Concrete	50mm	75mm
If using Warmup insulation board with timber or concrete	50mm	100mm

Technical notes

To fully utilise the long-term durability of your tiles, whether heated or not, it is important that the design, construction and preparation of the subfloor is carried out correctly.

It is essential that the subfloor be sufficiently rigid to support the ultimate weight that it will have to bear without movement or deflection. Wherever a timber subfloor is to be heated and tiled, it is strongly recommended that a Warmup insulation board be used as tile backer board prior to heating and tiling.

Waterproofing requirements will be determined based on installation methods and local regulatory requirements.

The installations should comply with the following Codes of Practice:

BRANZ - Good Tiling Practice

NZ Electrical Installation NZS 3000:2007

NZS 3100-2009

NZS 6110:2007

The choice of products for subfloor preparation and tile fixing will vary depending on the existing subfloor, preferred tiling system and choice of tile. This document is only intended to be an outline guide to laying ceramic floor tiles. Further help regarding floor preparation and tile application is available from the tile adhesive manufacturers.

Preparation of timber or concrete subfloor

Ensure adequate underfloor ventilation.

Securely fix existing floor boards and if necessary, pre-level with a latex/cement self-levelling compound to give a flush fit for the subsequently applied tile backer boards.

Using Warmup Insulation board

Fix the tile backer board as per manufacturer's instructions.

After attaching the board to the subfloor, the Warmup Undertile heating system may be laid directly on top of the tile backer/building board, and then tiled over. It is important to ensure that the tile adhesive and grout used are flexible and that the tile backer/building board has been fitted as per the manufacturer's instructions. High quality, cement-based adhesives with their flexible additives are most suitable.

UNDERTILE HEATING WITH WARMUP INSULATION BOARD INSTALLED ON A TIMBER FLOOR

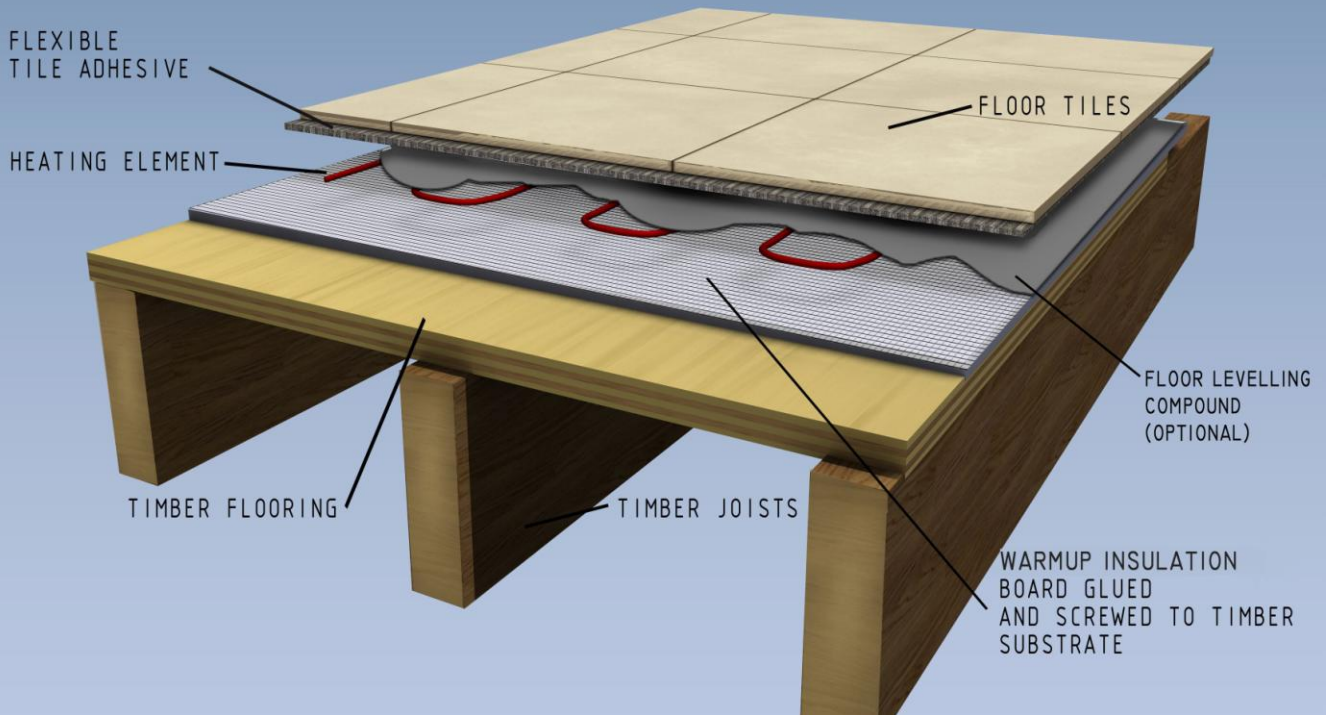

UNDERTILE HEATING WITH WARMUP INSULATION BOARD INSTALLED ON A CONCRETE FLOOR

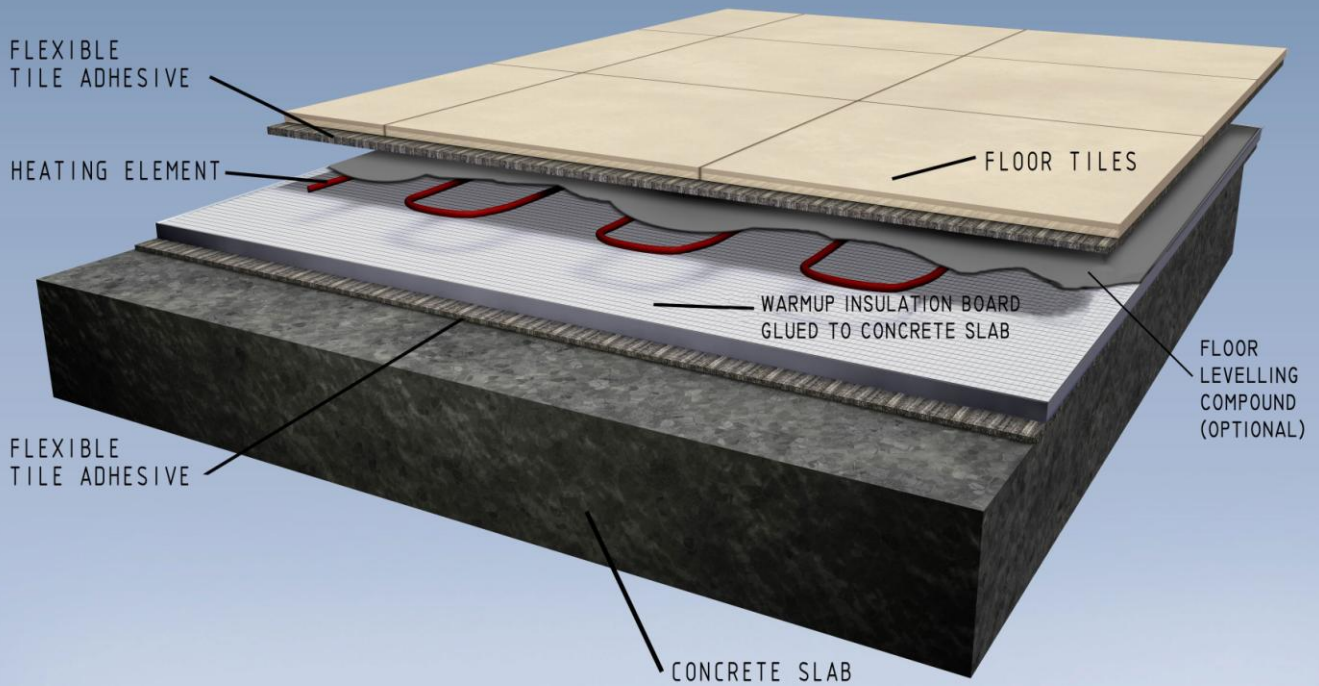

Wiring configurations

Whilst the installation instructions only make provision for the heating elements to be installed in a set configuration, there are many instances where departure from this configuration may be desirable. Below are a few drawings illustrating the versatility of the Warmup Undertile Heating System.

Bathroom

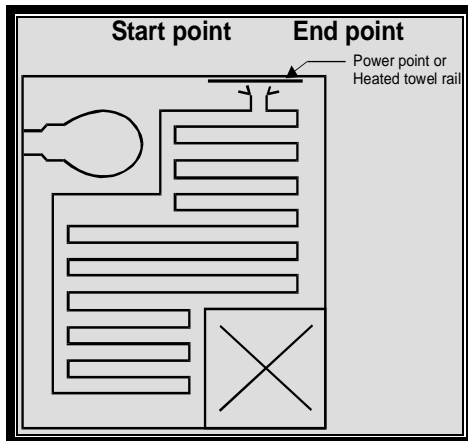

Room with recesses

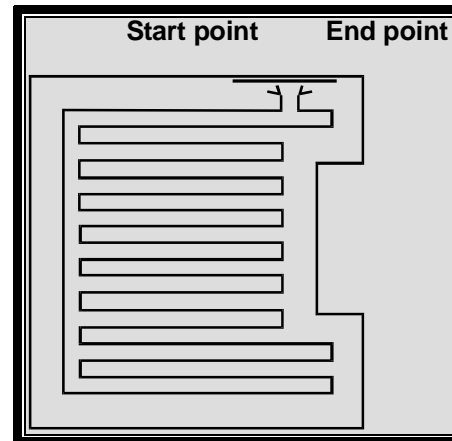

Standard room

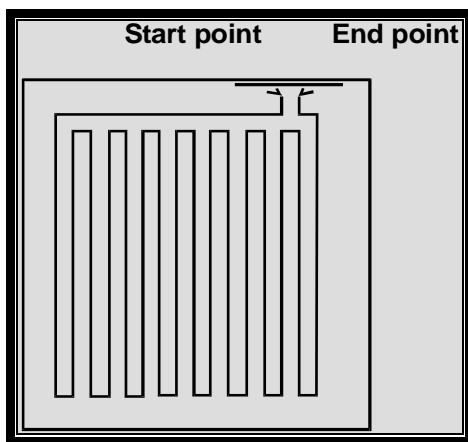

Room with central obstacle

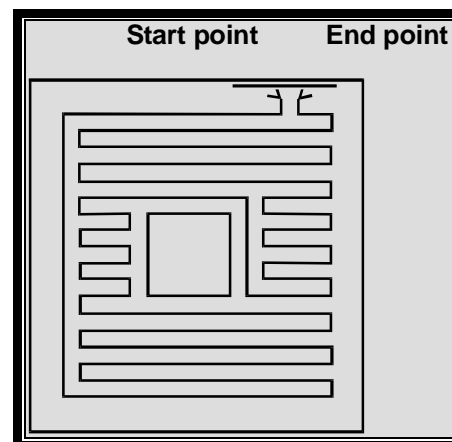

In each of the examples the floor space is heated using different wire configurations to suit the particular layout of the room. It should be noted that whilst the sizing chart provided in this booklet is a useful guide to heater layout, it may be necessary to slightly alter the heating wire spacing to suit your particular installation. However, at no time should the spacing between the wires be less than 50mm.

Most layouts will differ with every job.

Electrical requirements

Cross section for pre-wire requirements of undertile and undercarpet heating systems

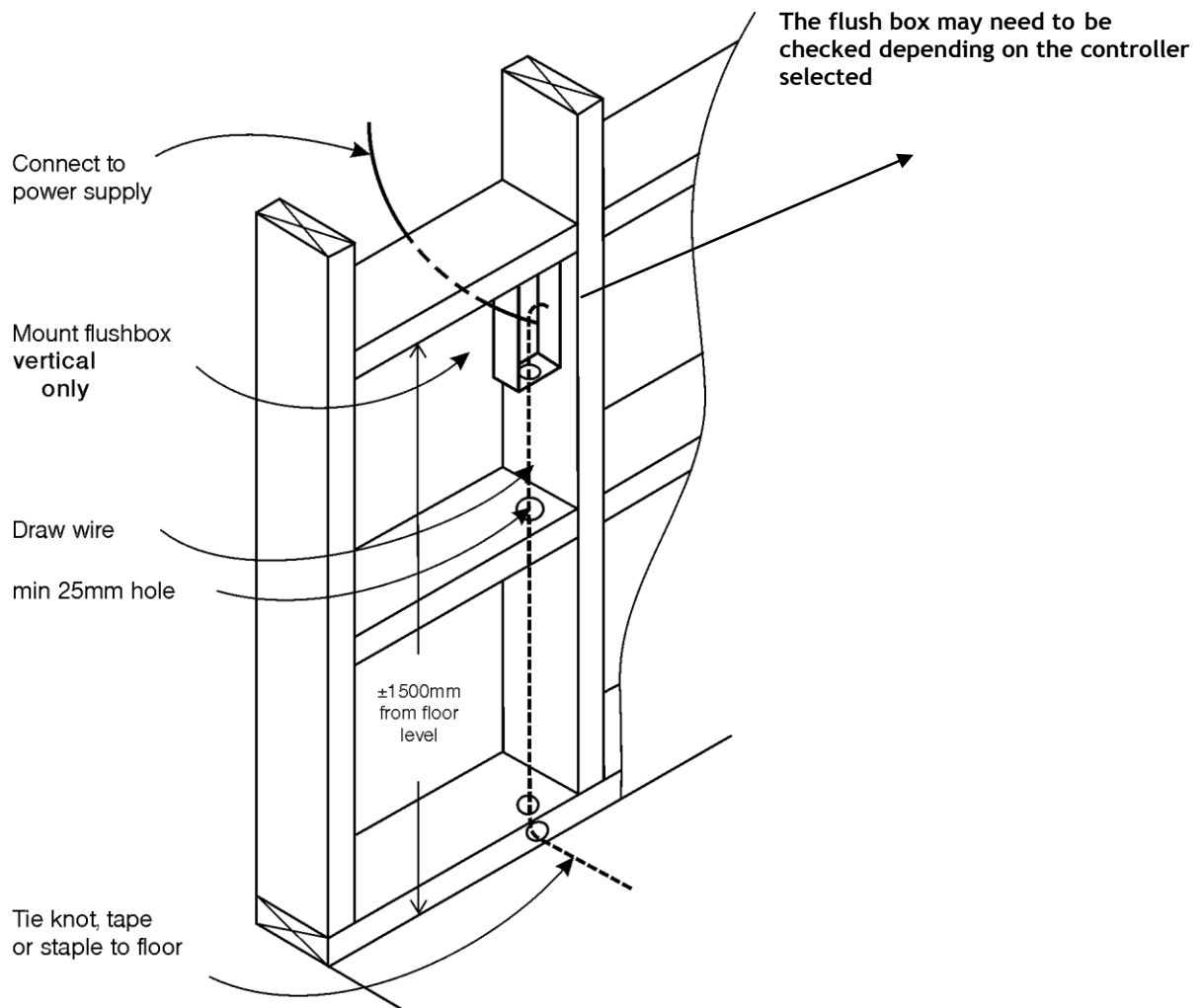

The heating elements must be protected by an RCD with a rated residual operating current not exceeding 30mA. The electrician must install a dedicated RCD or use an existing RCD.



Notes:

1. All our controllers are designed to fit **Vertical** flush boxes.
2. Height off the floor for flush boxes can vary with controllers.
3. The use of 2.5mm TPS as a draw wire is preferred. Ensure that it has a clear passage from floor to flush box.
4. Kindly contact us on **0800 WARMUP(927-687)** for any queries on pre-wire connections.

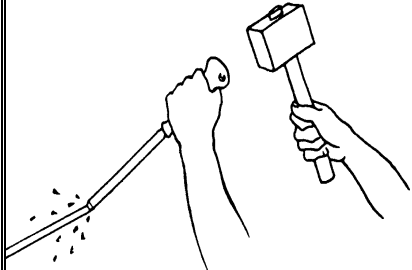
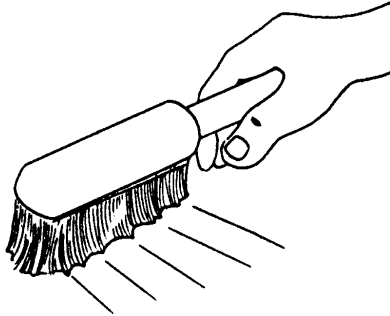
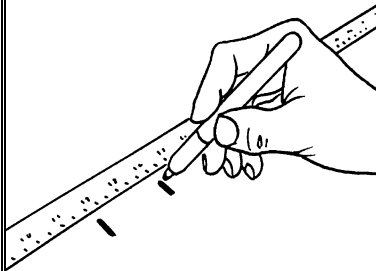
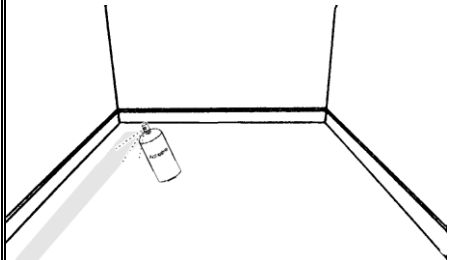
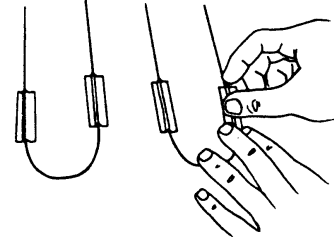
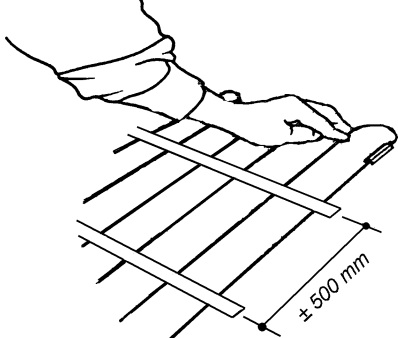
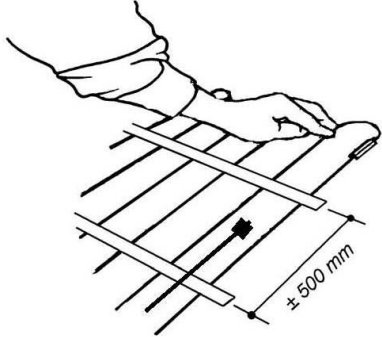
Simple steps to luxurious warmth

<p>1</p> 	<p>2</p> 	<p>3</p> 
<p>Chisel out channels for cold tail connections</p>	<p>Clean and sweep floor</p>	<p>Mark out element positions</p>
<p>4</p> 	<p>5</p> 	<p>6</p> 
<p>Spray adhesive to floor areas where the element will be looped</p>	<p>Tape element down with Warmup fixing tape</p>	<p>Band tape to hold the element at the correct centres</p>
<p>7</p> 	<p>8</p> 	<p>9</p> <p>Your floor is now ready for tiling</p>
<p>Fix floor probe</p>	<p>Test the element and fit the Watchdog continuity alarm</p>	

Simple steps to luxurious warmth

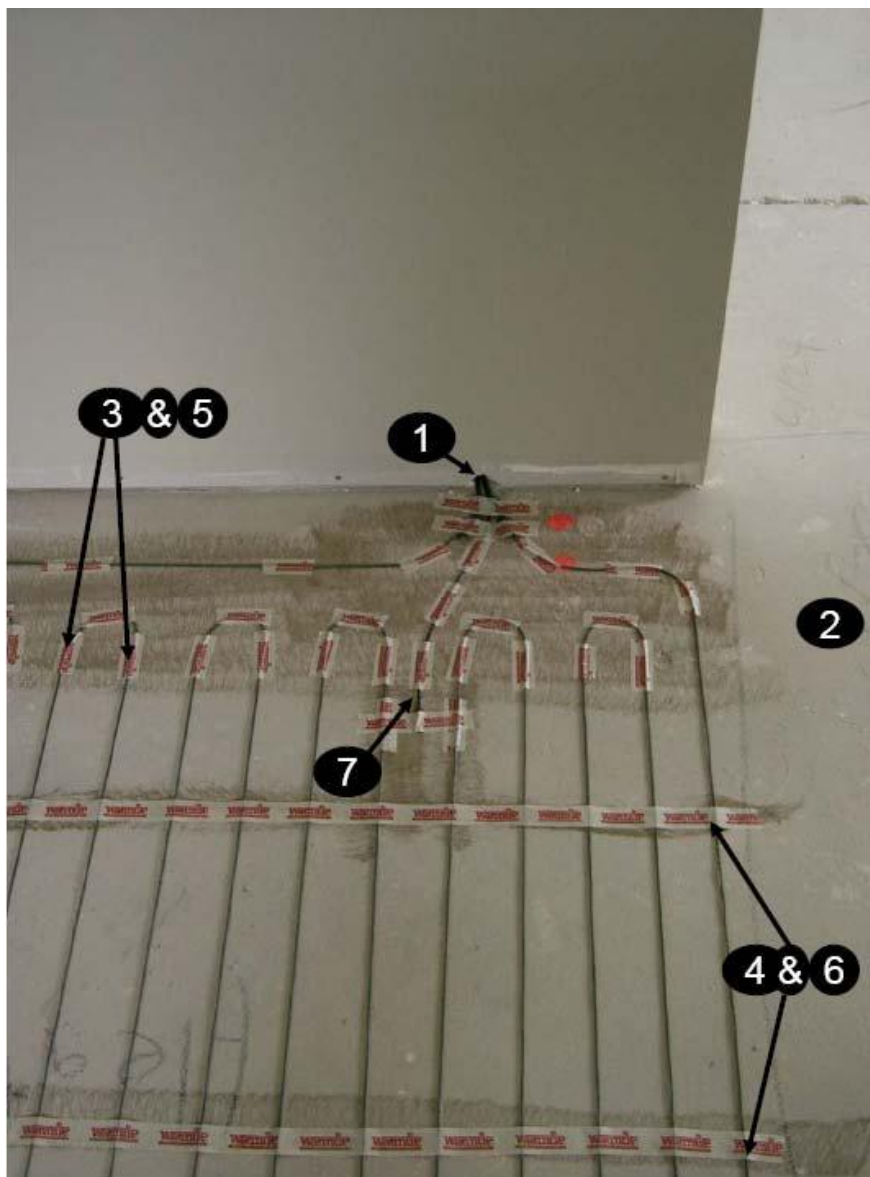

Note

- Your Warmup Heating element has been classified as an electrical appliance.
- You are therefore not required to be an electrician to install the element. But all electrical connections including the connection of the controller must be undertaken by a licensed electrician.
- Ensure all electrical supply circuits to the heating elements are protected via a RCD (Residual Current Device) protected circuit.
- Once the heater and controller have been installed and the tile adhesive has cured, the heater can be switched on.

Initial heat up time will vary depending upon the age of the floor, floor type (concrete or timber), time of year, thermal characteristics and insulation of your sub floor. The heat up times will improve with increased usage. Ensure your electrician reads the instructions supplied with the thermostat before connecting it.

Installation Steps 1 & 2

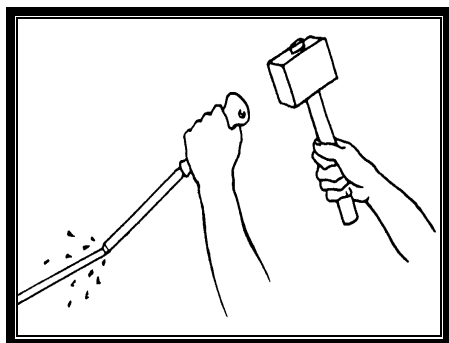

Chisel out channels for cold tails

1. Chisel out channels for cold tail connections

To ensure a flat floor surface, it will be necessary to chisel out or “chase” short channels in the subfloor at the “start point” and the “end point”. This minimises the increased height presented by the two black power supply cables. The start and end points of the heating element should be at least 50mm apart (no closer) maximum 100mm (see sizing guide).

Never cross over any of the heating elements.

If the element is being fitted to a solid concrete floor, it is essential that the concrete is fully cured to the manufacturer’s specifications. Also be aware that on a solid concrete foundation you may need to fix the element runs closer than the average of 75mm, as the concrete will draw away much of the heat and increasing the time it takes to heat up to temperature.

The lowest ambient temperature at which the heating element may be installed is 0deg and must be installed at a distance of at least 30mm from conductive parts of the building, such as water pipes.

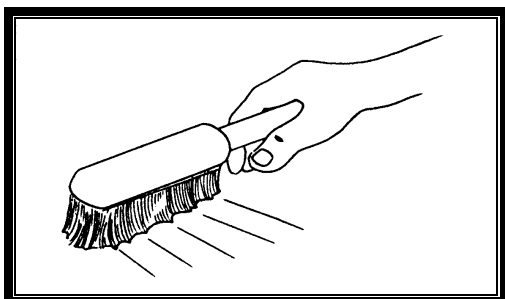

Clean and sweep floor

2. Clean and sweep floor

Ensure that the floor surface is smooth, dry and free from dust or grease.

Installation Steps 3 & 4

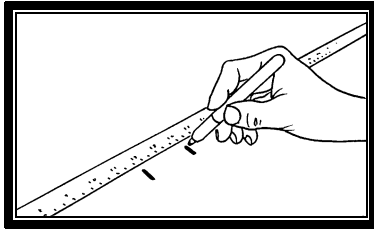

Measure up

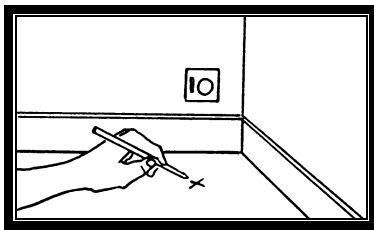

Mark start point

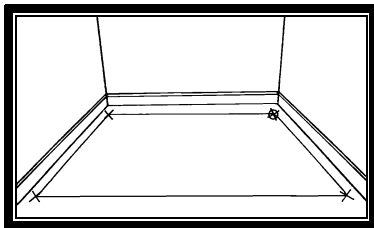

Mark corners and perimeter

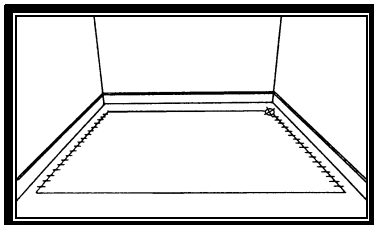

Mark spacing intervals

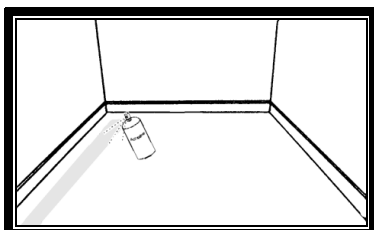

Spray adhesive

3. Mark the floor for element position

Calculate in square metres the actual area to be heated. Then using a sizing guide, establish the actual element spacings.

Using a fibre tipped pen mark a starting point no further than 1.5m from the power supply. The start point should be positioned as close as possible to the power supply.

Mark all the outer corners of the heated area observing the perimeter distances and join the corners up to form a marked out perimeter.

Mark up the spacing intervals for the element wire following the sizing guide plus your actual calculation. The spacing interval between the element wire must be at least 50mm apart. The maximum spacing interval that is recommended is 100mm.

4. Spray adhesive to floor areas where the element will be looped

Spray the floor with the adhesive spray along areas where the cable loops around, or where the element will require taping in place. The spray adhesive acts as a primer for the tape and should only be used where the element is to be taped to the floor. Allow to cure for approximately 10 minutes.

Installation Steps 5 & 6

5. Tape the heating element down with Warmup fixing tape

Once the floor has been marked up, the element wire can be laid out.

Gently unroll the power supply cable from the spool. After 3 metres of black cable has been removed, you will reach the point at which the power supply cable joins the heating element wire (which is of a different colour).

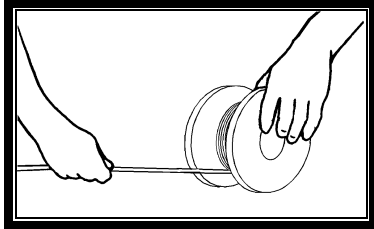

Unroll the power supply cable from spool

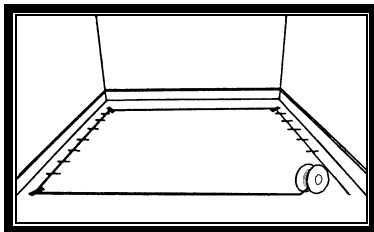

Lay wire out around perimeter from start point

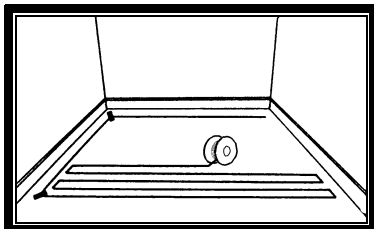

Lay out heating wire in parallel lines

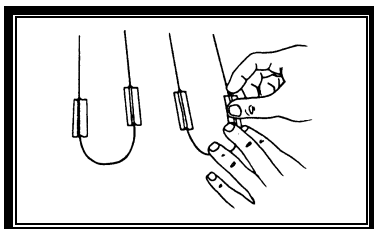

Space and secure wire with tape

The join of the power supply cable and the heating cable should be taped to the floor at the start point (which is the first of the chiselled channels).

Following the perimeter markings on the floor, lay out the heating element wire, taping down at each corner. The element wire should run from the **start point** in a U shape to the furthest corner from the start point.

Once the element wire has been laid out around the perimeter, start laying out the heater wire in parallel lines back and forth across the main body of the area to be heated.

Using the spacing markings, tape down the element to the floor with strips of the adhesive tape supplied (over the pre-sprayed areas). The tape strips should be about 25mm (1 inch) long.

You will also note a $\frac{1}{2}$ way marker indicating that you have used up $\frac{1}{2}$ the length of the heating element. Check the coverage of the floor already completed to gauge your end result.

Installation Steps 5 & 6

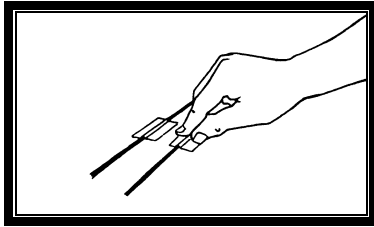

Tape down end point join parallel with start point

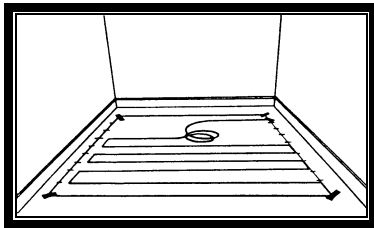

Lay out balance of wire

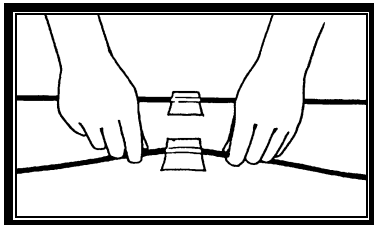

Adjust wire spacing if necessary

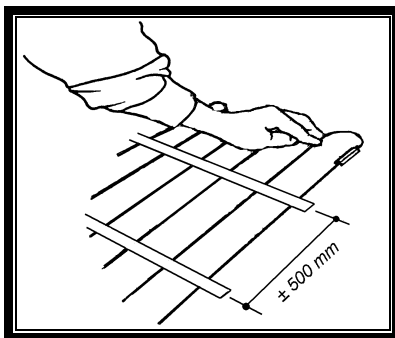

Secure the wire with tape and band the tape to hold the element in place

When you have completed about 90% of the element layout, gently unroll the remaining wire and the second power supply cable (black) from the spool. At the end point where the power supply cable meets the heating element you will find another join. Tape this join to the end point (which is the second chiselled channel), at least 50mm apart from the start point join that you taped down previously.

You will be left with a coil of unsecured element. This unsecured element should be laid out in reverse order i.e. starting from the end point and working backwards to the last point at which the element was taped down.

In order to achieve even coverage of the balance of the area to be heated, you may at this stage need to adjust some of the element spacing that you previously secured.

This can be achieved by untaping a few of the previous runs of element that you taped down, and re-fixing them at wider or narrower intervals. You may wish to alter the element layout to fit your particular requirements. Where there are irregularities of shape you can lay out the element to provide warmth around toilets, etc. This is quite acceptable provided that:

- The element is spaced at least 50mm apart at all times. Not closer.
- The element should never cross over.
- The heating part of the element is never within the wall cavity.

Once the laying of the element is complete, meaning the black leads are both back to the starting point, these will need to be carefully pulled up within the wall cavity using the draw wire.

6. Band the tape to hold the element

Once the heating element is completely laid out, spray adhesive across the element at right angles to the wire and band Warmup fixing tape to hold the element at the correct centres.

Installation Step 7

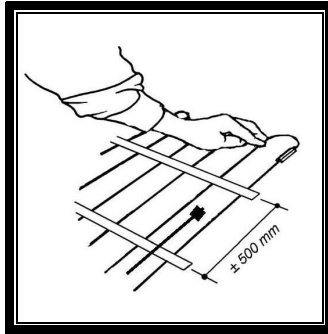

Fix floor probe

7. Fix floor probe

- One of the final steps is to fit the floor probe. The probe goes up through the wall cavity with the power supply cables, therefore you need to make sure there is enough wire from the probe to go up to where the controller is to be fitted.
- Secure the additional wire from the probe by running it along the floor and up in between two rows of heating element and tape on the floor as far as you can. The closer to the centre of the floor you can get is the best option but it must not cross over any other wires on the floor.
- Now the laying of the floor is complete, the two power supply cables and the probe wire will need to be very carefully pulled up through the wall cavity using the draw wire.

Installation Steps 8 & 9

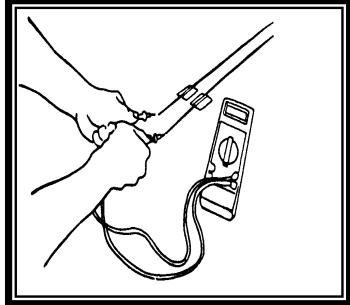

Check resistance using a multi-meter

8. Testing the heater (Prior to and during tiling/tiling procedures)

Your Warmup undertile heater has been comprehensively tested prior to sale. You should retest the heater by using the following method

Check the resistance on the heater, using a multi meter and confirm the reading against factory specifications (label on the cardboard spool).

Test the heating element using an insulation tester (min. voltage 500V).

Connect the Watchdog continuity alarm (supplied with each heating element). Follow the connection instructions.

If the alarm sounds during the tiling procedure, stop all work and call for technical assistance on 0800 WARMUP (927-687).

After the tiling and grouting procedure has been completed, the checks 1 and 2 need to be repeated.

The electrician needs to complete the test report label as provided and attach to either the cold tails or switchboard.

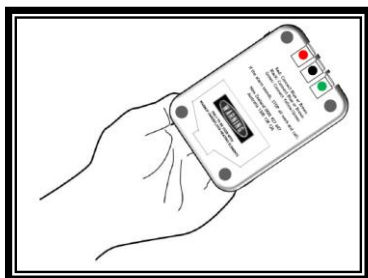

Check and test the Watchdog continuity alarm

9. Connection and testing of the Watchdog Continuity alarm

Ensure that the batteries are correctly installed.

Test by turning the switch to the ON position and ensure that the audible alarm sounds. If the alarm sound cannot be heard, please call for technical assistance on 0800 WARMUP (927-687).

Turn to the OFF position during connection to the heating element and then turn it ON.

Note: When the heating element is connected to the Watchdog continuity alarm and turned on, there should be no alarm sound audible. **Your floor is now ready for tiling**

Do's and don'ts

- DO** Carefully read this installation manual before commencing installation.
- DO** Ensure a smooth, clean and dry surface before beginning installation.
- DO** Plan the heater layout and stick to recommended wire spacing and perimeters.
- DO** Space the element evenly over the floor.
- DO** Plan post-tiling drilling (e.g. for fixing sanitary ware, door stops) so as not to damage the wiring.
- DO** Make sure that all the element wire is positioned under the tiles in the installation.
- DO** Protect the element with cardboard or hardboard between installation and tiling.
- DO** Use tile adhesives and grouts suitable for use with underfloor heating.
- DO** Check that the heater is working before commencing tiling.
- DO** Take particular care when tiling not to dislodge or damage the heater element.
- DO** Ensure that each tile is solidly bedded in the adhesive, with no gaps or voids.
- DO** If in doubt about the suitability of the sub-floor to be heated, check with your local tile shop, tiler or call the Warmup technical helpline.

- DON'T** Commence installation on a concrete floor that has not been fully dried.
- DON'T** Cut or attempt to shorten the element wire at any time.
- DON'T** Allow traffic over the installed heater before tiling.
- DON'T** Remove the heating element from the spool other than during installation.
- DON'T** Allow the heating wires to cross over or touch each other at any point.
- DON'T** Store tiles, sharp or heavy objects on any of the wiring whilst tiling.
- DON'T** Commence tiling before testing the heater using the cable alarm.
- DON'T** Switch on the heater until tile adhesive has fully dried (7 days minimum)

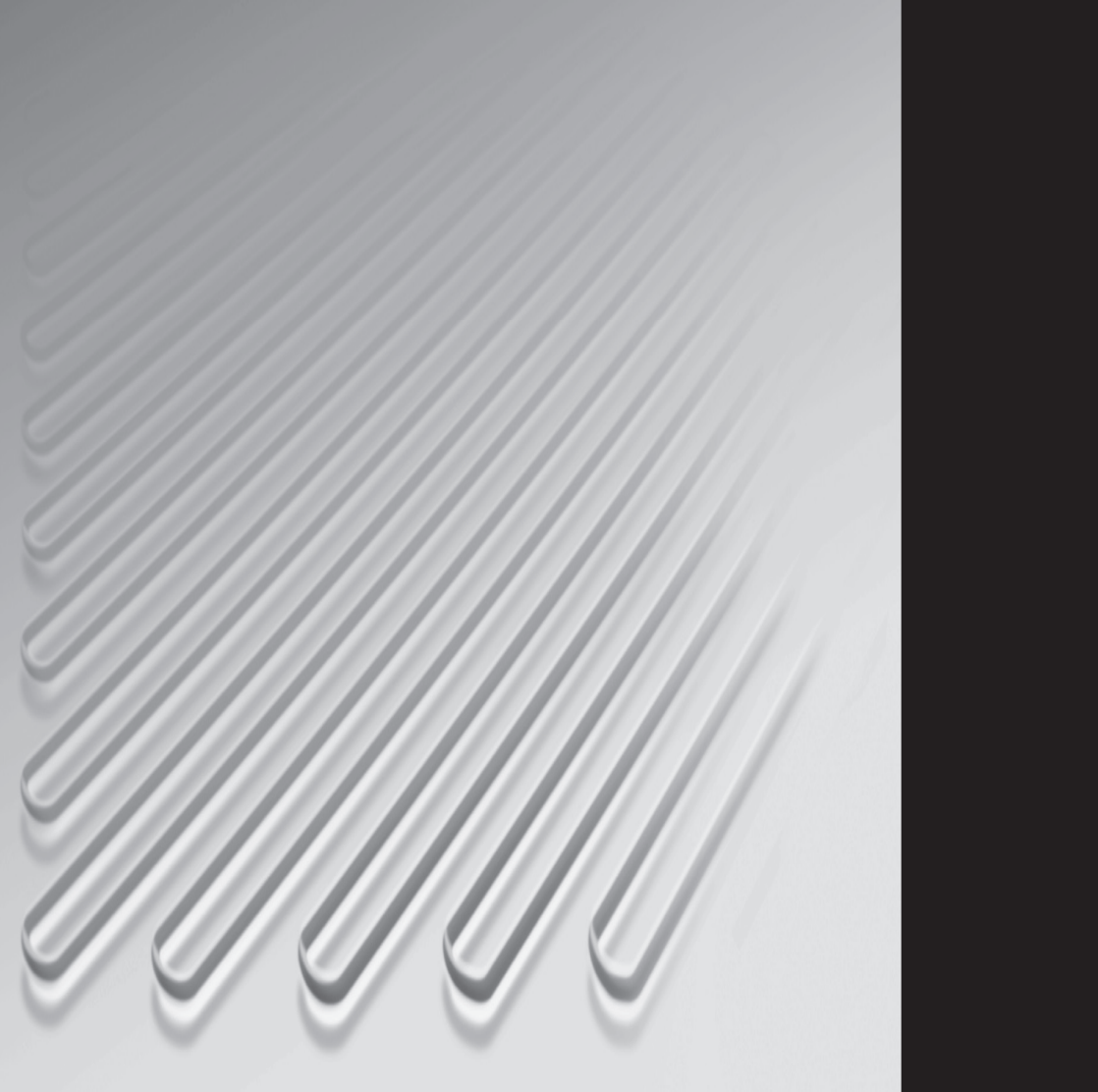

Warmup New Zealand Ltd
Freephone: 0800 927 687 Website: www.warmup.co.nz Email: info@warmup.co.nz