

DYNEX cavityclosers

Dynex Cavity Closers
 Bottom Plate Flat Cladding 20mm Cavity

Scale:	1:2
Do not scale from drawings. Contact Dynex Extrusions Ltd for exact dimensions www.dynex.co.nz 0800 4 DYNEX (0800 4 39639)	
Date:	January 2018
Detail no:	CC-01

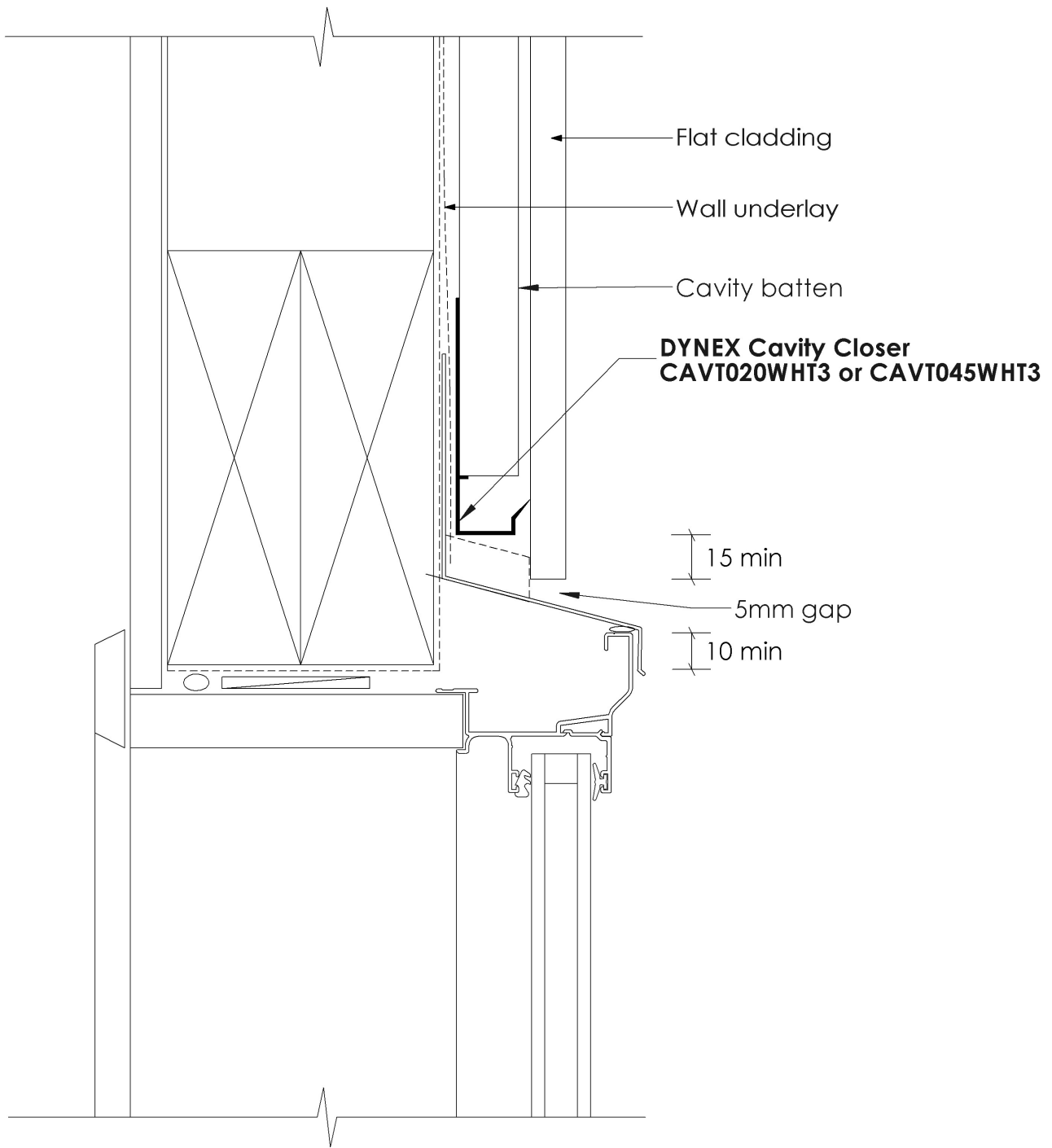

DYNEX cavityclosers

Dynex Cavity Closers
Window Head Flat Cladding

Scale:	1:2
Do not scale from drawings. Contact Dynex Extrusions Ltd for exact dimensions www.dynex.co.nz 0800 4 DYNEX (0800 4 39639)	
Date:	January 2018
Detail no:	CC-02

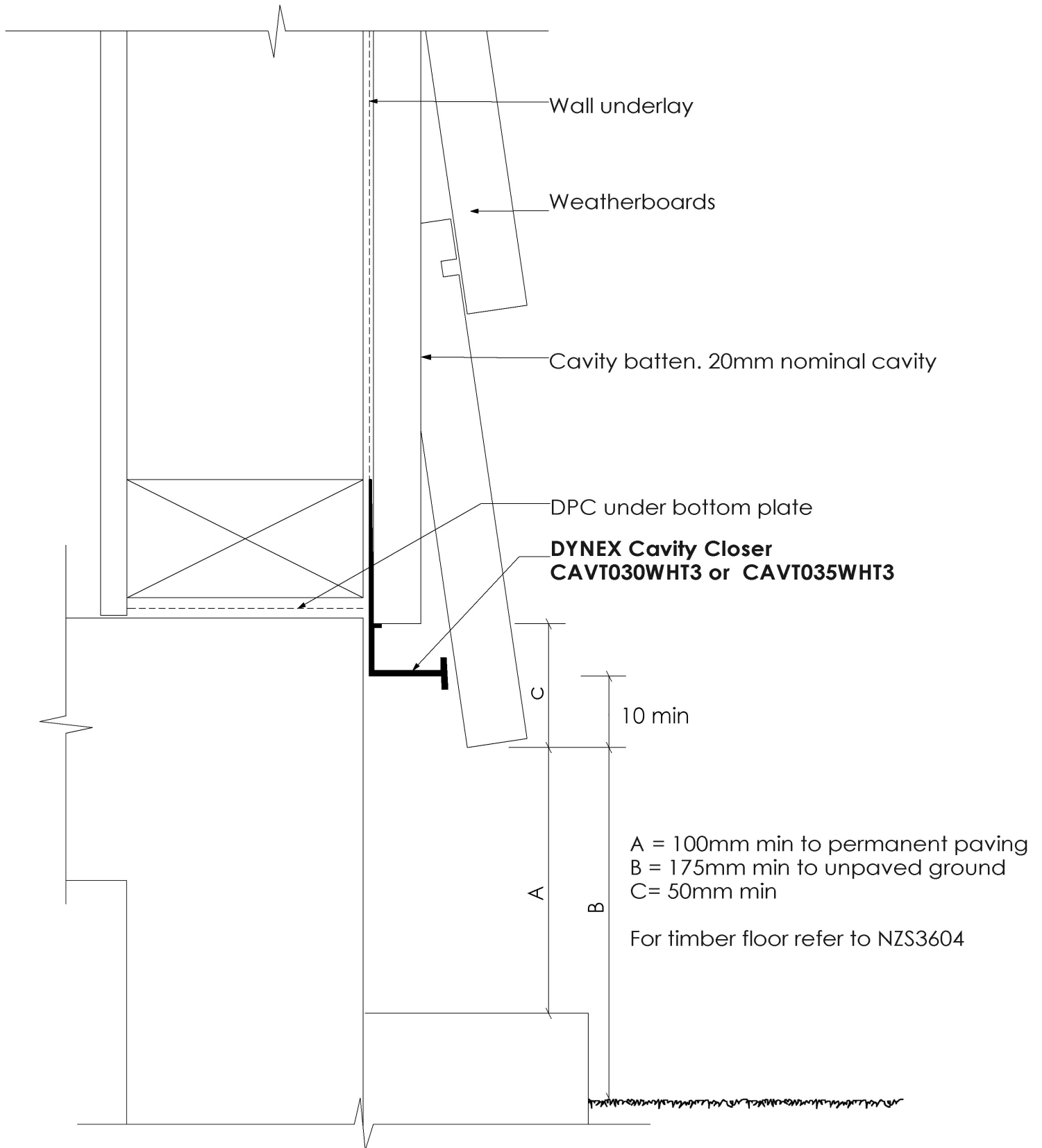

DYNEX cavityclosers

Dynex Cavity Closers
Bottom Plate Weatherboards

Scale:	1:2
Do not scale from drawings. Contact Dynex Extrusions Ltd for exact dimensions www.dynex.co.nz 0800 4 DYNEX (0800 4 39639)	
Date:	January 2018
Detail no:	CC-03

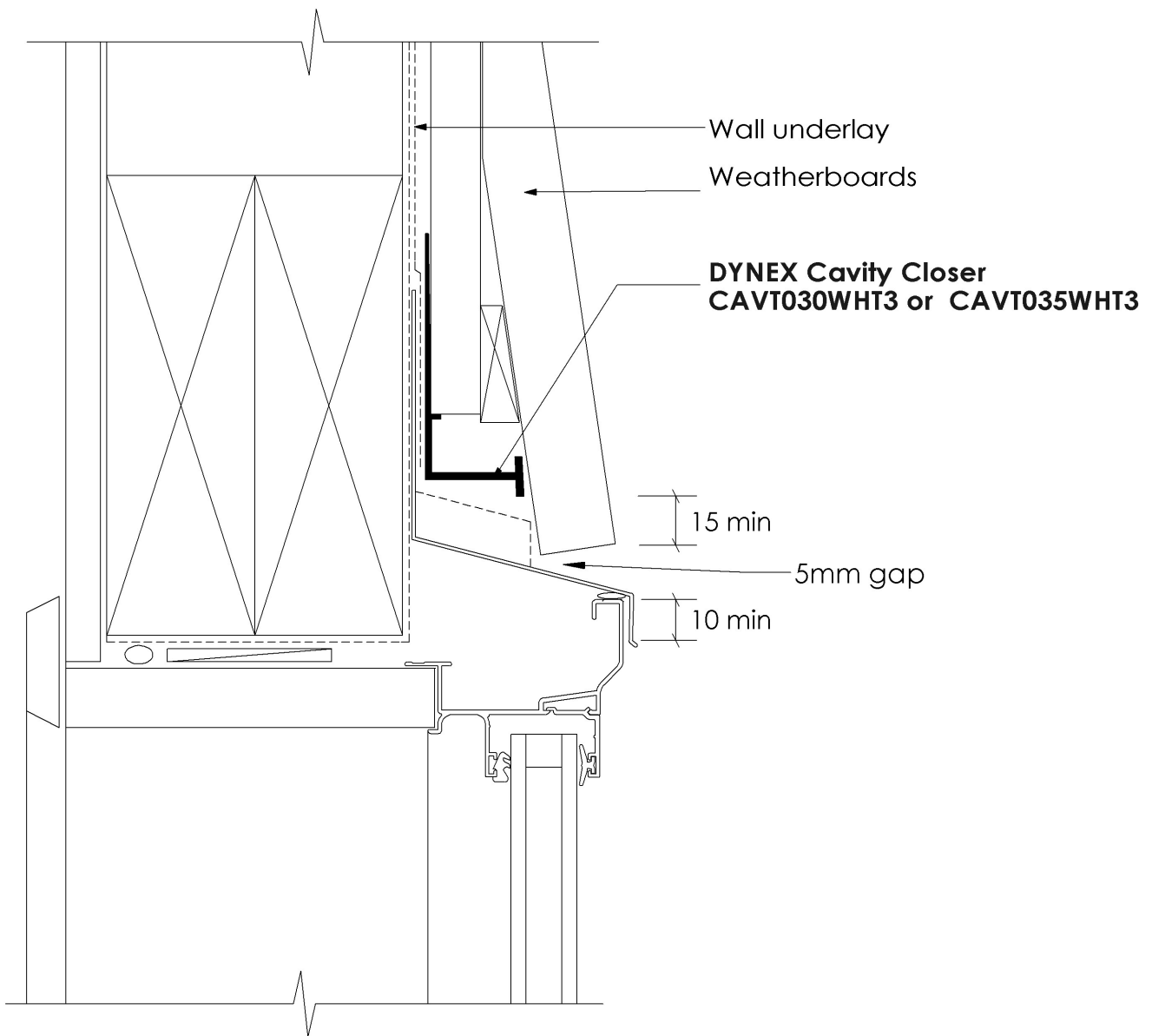

DYNEX cavityclosers

Dynex Cavity Closers
Window Head Weatherboards

Scale:	1:2
Do not scale from drawings. Contact Dynex Extrusions Ltd for exact dimensions www.dynex.co.nz 0800 4 DYNEX (0800 4 39639)	
Date:	January 2018
Detail no:	CC-04

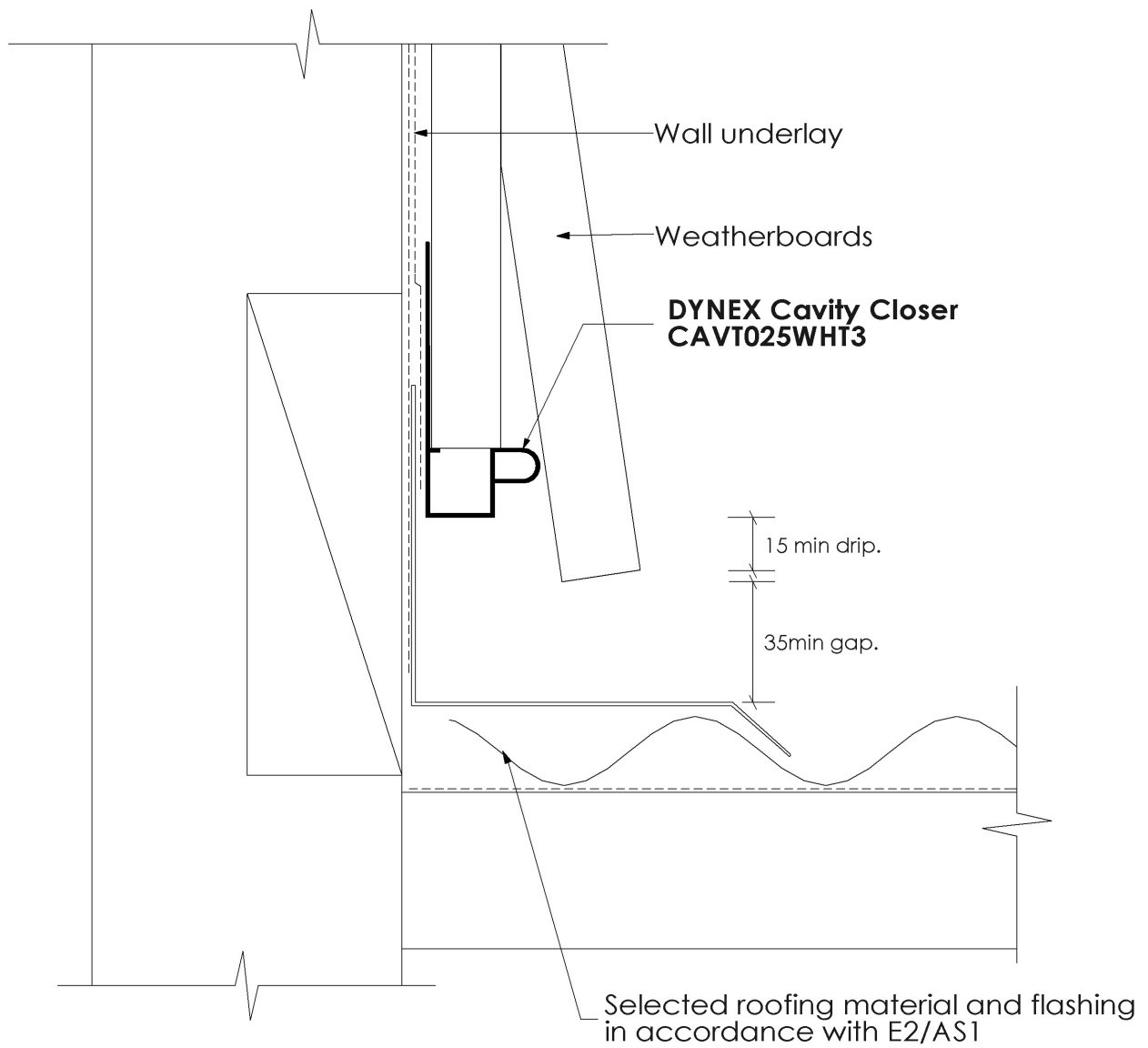

DYNEX cavityclosers

Dynex Cavity Closers
Raked Roof Closer

Scale:	1:2
Do not scale from drawings. Contact Dynex Extrusions Ltd for exact dimensions www.dynex.co.nz 0800 4 DYNEX (0800 4 39639)	
Date:	January 2018
Detail no:	CC-05

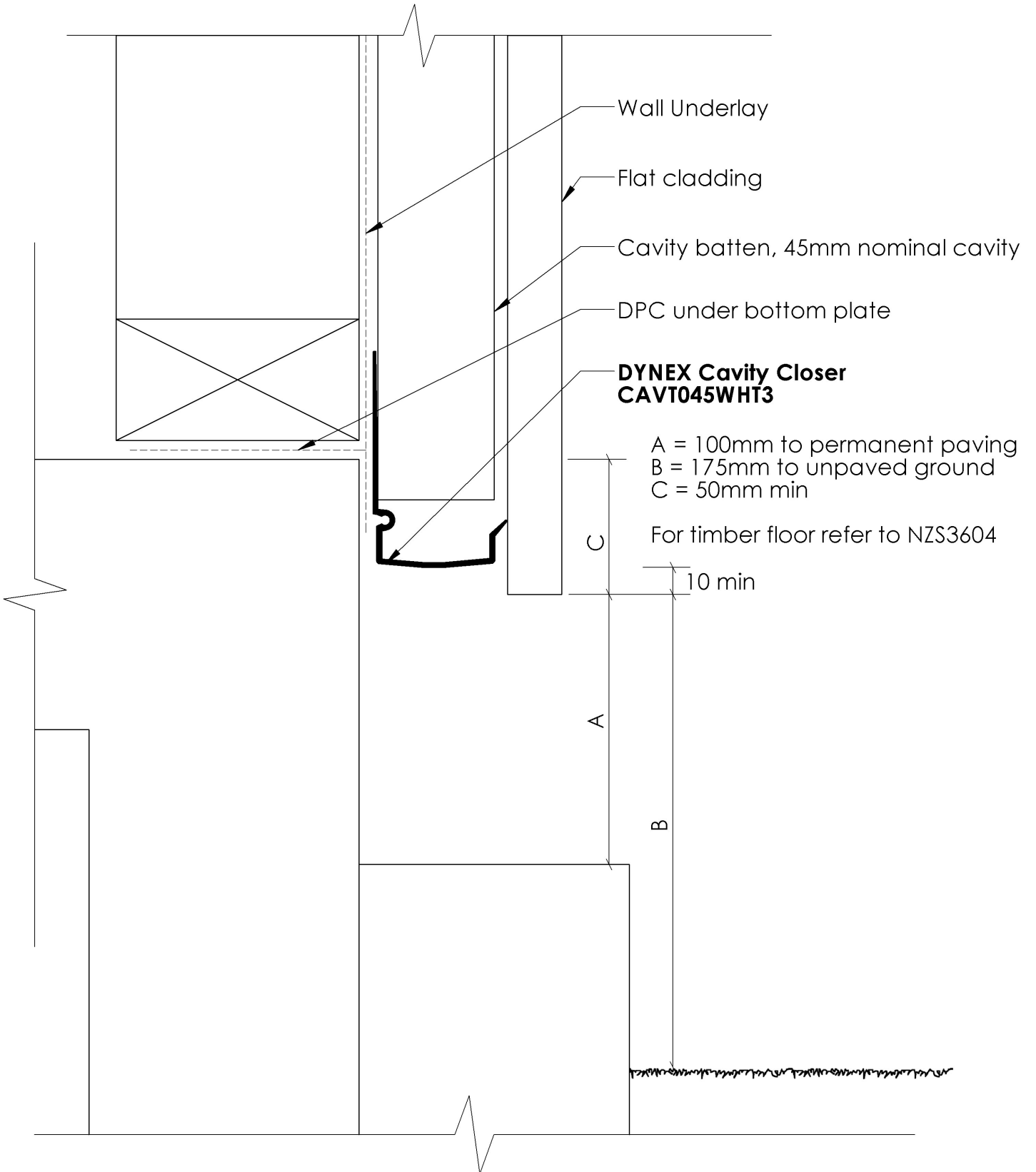

DYNEX cavityclosers

Dynex Cavity Closers
Bottom Plate Flat Cladding 45mm Cavity

Scale:	1:2
Do not scale from drawings. Contact Dynex Extrusions Ltd for exact dimensions www.dynex.co.nz 0800 4 DYNEX (0800 4 39639)	
Date:	January 2018
Detail no:	CC-06

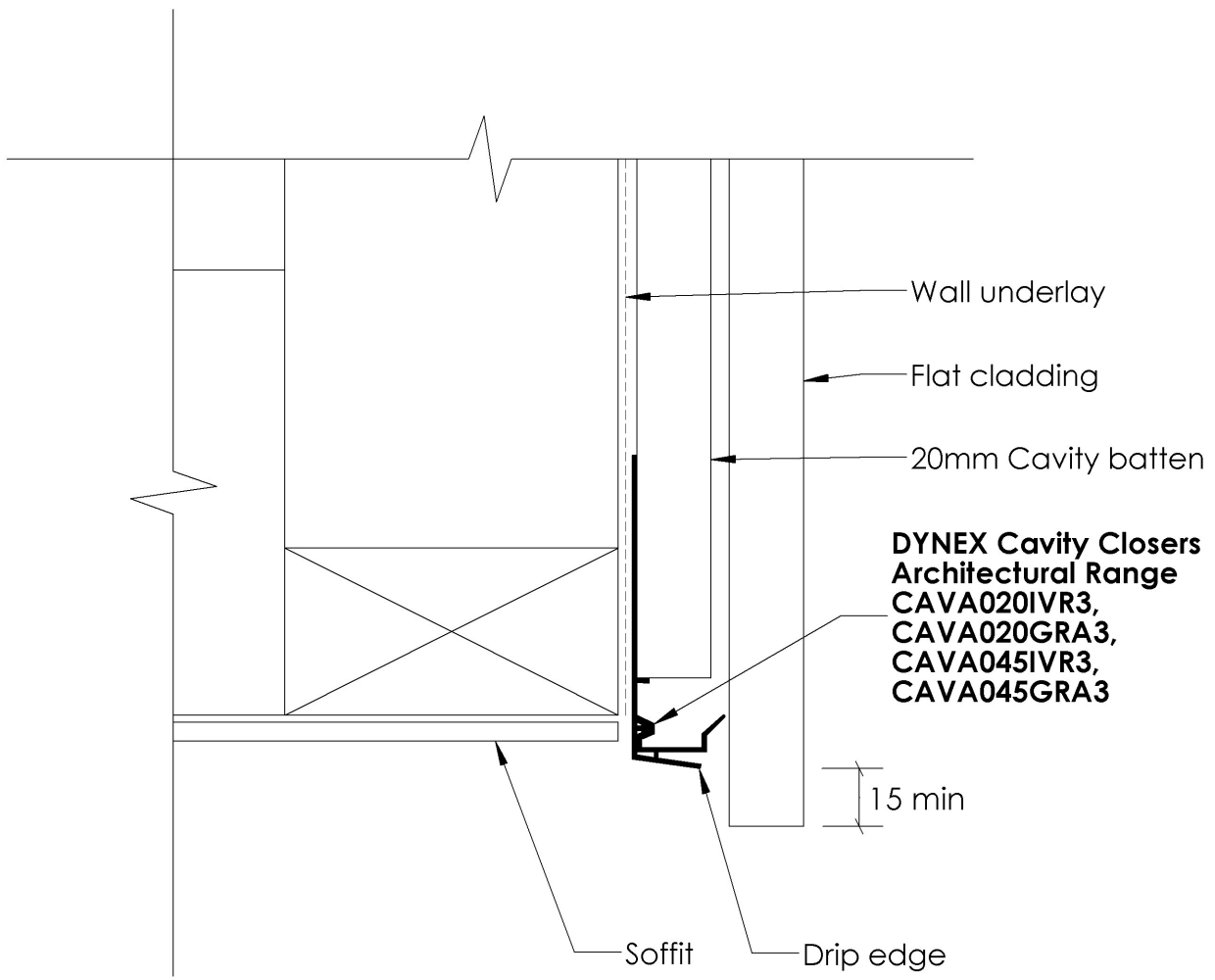

**DYNEX Cavity Closers
Architectural Range
CAVA020IVR3,
CAVA020GRA3,
CAVA045IVR3,
CAVA045GRA3**

15 min

	<p>Dynex Cavity Closers</p> <p>Architectural Cavity Closer at Soffit</p>	<p>Scale: 1:2</p>
		<p>Do not scale from drawings. Contact Dynex Extrusions Ltd for exact dimensions www.dynex.co.nz 0800 4 DYNEX (0800 4 39639)</p>
		<p>Date: January 2018</p>
		<p>Detail no: CC-07</p>

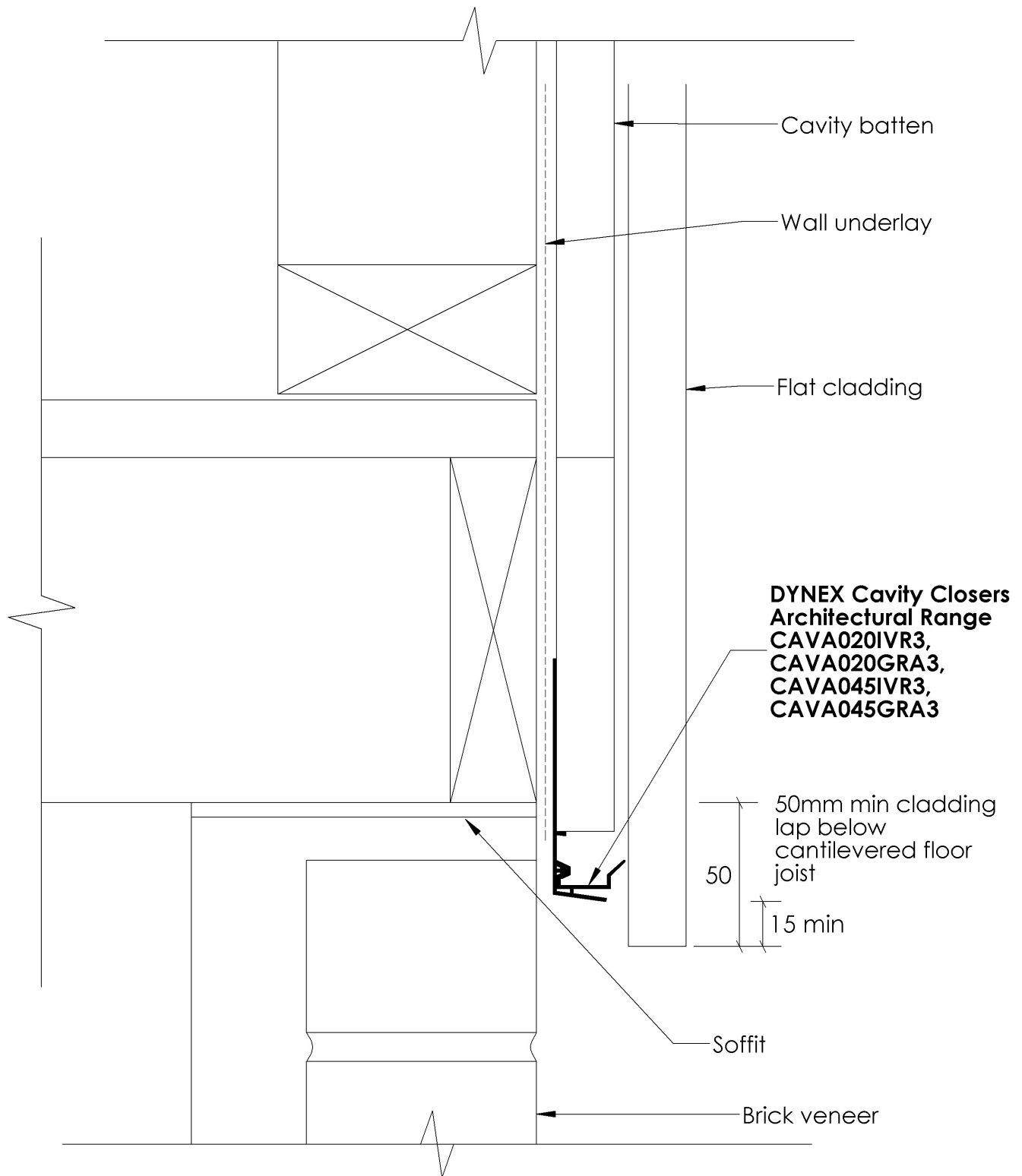

DYNEX cavityclosers

Dynex Cavity Closers

Architectural Cavity Closer at Interstorey
Junction

Scale:	1:2
Do not scale from drawings. Contact Dynex Extrusions Ltd for exact dimensions www.dynex.co.nz 0800 4 DYNEX (0800 4 39639)	
Date:	January 2018
Detail no:	CC-08