



Metalcraft
Roofing



STRUCTURAL GUIDE

Version 2.0 November 2016

CONTENT

WHO WE ARE 5

Introduction	6
Producer Information	7
Design Considerations	9
MSS & MC Design & Selection	10

MSS PURLINS 12

Product Innovations	14
MSS Section properties	16
MSS Section geometry	17
Single Span Guide	18
Single Span	19
Two Span Lapped	34
Three Span Lapped	49
Lapped Multispan (End Span)	64
Lapped Multispan (Internal Spans)	79
Single Span Axial Load Table	94

MSS PURLINS CONTINUOUS 100

Two Span Continuous	102
Three Span Continuous	117
Multispan Continuous (End Span)	132
Multispan Continuous (Internal Spans)	147

BRACING 162

MSS Purlin Hole Details	164
Lapped MSS Purlins	165
Bracing Systems	166
Camlock™ Bracing Components	168
Standard Bracing Systems	170
General Purpose Brackets	173
Continuous Span MSS Purlins Splice Joint	174

MC PURLINS 178

MC Section Geometry	180
MC Section Properties	181
MC Purlins Span Guide	182
Single Span (Inwards Load)	183

MS TOPHATS 188

MS Tophats Design Guide	190
MS Tophats Span Guide	191
Single Span (MS Tophat)	192
Lapped Span (MS Tophat)	194
MS Tophats Section	196
MS Tophats Floor Joist Spans	197

MSS SINGLE SPAN FLOOR JOISTS 198

Floor Rigidity Notes	200
MSS Single Span Floor Joists	201
Floor Joist Span Comparisons	205

ORDER FORMS 209



WHO WE ARE

METALCRAFT ROOFING

We have been operating since the 1950's and originated in the lovely town known as Palmerston North. With more than 50 years experience in the industry, we have established a reputation for both manufacturing high quality roll formed products and for providing an unrivaled level of service.

We consider ourselves to be New Zealand's largest privately owned roofing company and experts at manufacturing. We manufacture a wide range of products using locally sourced steel from New Zealand Steel. Solid material warranties backed by New Zealand Steel will give you an assurance of quality and peace of mind.



We also operate two structural manufacturing plants which share production sites with the Metalcraft Roofing branches at Auckland and Christchurch. These branches manufacture and supply a wide selection of purlins, girts and tophats to the construction markets in New Zealand.

We are members of the Roofing Association, New Zealand and the NZ Metal Roofing Manufacturers Incorporated.



METALCRAFT INSULATED PANEL SYSTEMS

Metecno NZ Ltd trading as Metalcraft Insulated Panel Systems is our sister company and specialises in the manufacture, supply and installation of insulated panels.

Metecno NZ is part of Metecno Group, an international Group of companies operating in the insulation panel sector since 1961.

All products are backed by solid warranties and the range of insulated panels, supplied by Metalcraft Insulated Panel Systems, is used in a variety of applications from Industrial and Commercial Coolstore to Agricultural and Architectural buildings.

SUSTAINABILITY

The environment is an issue that affects us not only as individuals but also the business activities in which we participate. As a member of the construction industry Metalcraft Roofing is proud to be involved in rollforming a product that is recyclable. New Zealand Steel, who is Metalcraft Roofing's key supply partner, has produced informative material which looks at the various aspects of steel manufacturing and its impact on the environment.

DURABILITY

Metalcraft Roofing's MSS Purlins and Girts, MC Sections, Bracing Systems and MS Tophats will meet a service life of up to 50 years. Compliance with the conditions stated in the New Zealand Steel Durability Statement June 2016 will ensure that the durability requirements of NZBC Approved Document B2 are satisfied.

The MSS Purlins and Girts are manufactured from high tensile Z275 galvanised coil in accordance with AS1397. MSS Purlins and Girts provide an efficient, lightweight rollformed support system for roofing and wall cladding and are recognised as being efficient, economical structural members suitable for a wide range of building applications.

UNITED INDUSTRIES GROUP LIMITED

Both ourselves and Metalcraft Insulated Panel Systems are part of United Industries Group Limited. United Industries is heavily involved in providing materials and services to the New Zealand construction market through its group companies.

For more information on United Industries, please visit: www.unitedindustries.co.nz

INTRODUCTION

This publication has been prepared to assist the designer in specifying Metalcraft Super Span (MSS) Purlin and Girts, Metalcraft 'C' Section (MC Section), complete with either Camlok™ or Standard Bracing systems and MS Tophats.

MSS Purlin and Girts, MC Sections, with the Camlok™ or Standard Bracing system are designed for use as a bolted framework system used with primary structural steel work. They are supplied cut to length and can be pre-punched with a variety of holes to suit a number of applications. Purlins, Girts and Bracing are rollformed to provide an efficient, lightweight support system for roofing and wall cladding and are recognised as being efficient, economical structural members suitable for a wide range of building applications.

The Camlok™ Purlin Bracing system provides a complete, efficient, cost effective and easily erected system. MSS Purlin and Girts, and MC Sections, complete with either Camlok™ or Standard Bracing systems and components are a complete system, supplied ready for erection and will require minimal maintenance throughout the life of the building. The Z275 galvanised finish on the purlins and bracing systems, give an excellent corrosion protection and reduces the need for painting. MSS Purlin and Girts, MC Sections, Bracing systems and MS Tophats, comply with New Zealand Building Code, and are designed to AS/NZS 4600:2005 Cold formed steel structures.

MS Tophats can be used for roof purlins, wall girts and floor joists, and are an economic option for these and other applications. They are an economical alternative to timber and 'C' section purlins for spans up to 7 meters.

Easy to use they fasten directly to their supports which eliminates the requirements for cleats. Being symmetrical there is no requirements for braces or nogs to prevent twisting and allows the profile to be easily lapped for maximum performance. MS Tophats are manufactured from high strength galvanised steel coil, the Z275 minimum coating provides good protection in most exposed internal environments. Consideration should be given when used in a lined exterior dwelling. Thermal breaks are required between the tophat and cladding to avoid thermal bridging. Contact with materials not compatible with zinc should be avoided.

HANDLING AND STORAGE

The presence of water between the stacked sections will create premature corrosion, it is recommended the sections are separated and dried if this situation occurs. Cutting if required should be done with hacksaws or snips, the use of abrasive disc blades are not recommended.

EFFECTIVE DESIGN WIDTH

Metalcraft Roofing does not provide values of the effective design width of section elements and where required this must be considered by the Design Engineer.

DISCLAIMER

This publication is intended to provide accurate information to the best of our knowledge in regards to MSS Purlin and Girts, MC Sections, Bracing systems and MS Tophats Sections. It does not constitute a complete description of the goods nor an express statement about their suitability for any particular purpose. All data is provided as a guide only and Metalcraft Roofing, Blueprint Consulting Engineers Ltd and the University of Sydney do not accept any liability for loss or damage suffered from the use of this data.

USE OF THIS MANUAL

The user of this manual is responsible for ensuring that this document is the most recent revision prior to using the information within for design purposes.

When selecting purlin systems for projects the specifier must consider the impact of the actual applied loads versus the stated capacities for the system as specified in the manual. Actual loading, while it may be less than stated values does not necessarily ensure adequacy of the selected system as member adequacy is highly dependent on the maximum moments applied and the moment profile in the member span. Such design actions can be significantly altered by the variations in the actual project specific calculated applied loads, and accordingly the Design Engineer is responsible for verifying their purlin selection complies with AS/NZS4600:2005.

MANUAL UPDATES

The user of this manual is responsible for ensuring this manual is the current revision prior to using and information contained within.

PRODUCER INFORMATION

EXTENT AND LIMITATION OF USE

MSS Purlins and Girts, MC Sections, with a Camlok™ or Standard Bracing system, and MS Tophats will depend on spans, loads, bridging and product sizes and should be used with the information provided within this manual. Design and use of these products outside the information provided may result in a reduction in performance.

MATERIAL SPECIFICATIONS

The galvanised coating used on the steel to manufacture MSS Purlins and Girts, MC Sections, Bracing Systems and MS Tophats is designed for internal use only. The coating must be kept clear of corrosive environments and should not be used in contact with chemically treated timber or other treated products in the presence of moisture. If there is evidence of damage to the coating, the area should be cleaned and spot primed to the suppliers specifications.

Product	Steel Grade Thickness	Base Metal mm	Zinc Weight
MSS Sections	G500 (Mpa)	<1.5	275 gm/m ²
MC Sections	G500 (Mpa)	<1.5	275 gm/m ²
MSS Sections	G450 (Mpa)	>1.5	275 gm/m ²
MC Sections	G450 (Mpa)	>1.5	275 gm/m ²
Bracing	G250 (Mpa)	1.15	275 gm/m ²
Sag Rod		12mm Dia 16mm Dia	Zinc Plate to AS1789 or Galv to AS1640
Tophat	G550 (Mpa)	<1.00	275 gm/m ²
Tophat	G500 (Mpa)	>1.00 <1.5	275 gm/m ²
Tophat	G450 (Mpa)	>1.5 <2.25	275 gm/m ²

PRODUCT HANDLING, STORAGE, INSTALLATION & MAINTENANCE REQUIREMENTS

MSS Purlins and Girts, MC Sections and Bracing Systems must be handled, stored and installed using the procedures outlined in this document. The following factors could limit the performance of the product.

- Site or storage or transit exposure that allows the product to get wet and trap water between flat surfaces. If this happens the product should be dried and restacked.
- Damage to the profile of surface coating during, handling, storage, installation or by other trade work.
- The product must be installed in a manner for which they were designed without imposing excessive loads during construction or in their later use.
- All fixing to the structural steelwork including fitting of bracing must be completed before any loads are imposed.
- All ancillary products must be of the correct size and designed as specified.

Other work such as welding, gas cutting or drilling should be carried out under the Design Engineers Supervision as some loss of strength may occur.

USAGE OUTSIDE GUIDELINES

Where MSS Purlins, Girts, MC Sections, Bracing systems and MS Tophats are being used outside the limitations and procedures given in this manual together with any doubt as to the handling, storage or installation of this product, written approval should be obtained from the manufacturer for any such specific project and prior to the project commencing.

PRODUCER INFORMATION

N.Z.B.C COMPLIANCE

Use of the MSS Purlins and Girts, MC Sections, Bracing systems and MS Tophats in accordance with the stated guidelines and limitations thereby complies with NZBC Approved Documents:

B1 Structures
B2 Durability

Past history of galvanised steel products in dry interior environments indicates a life of up to 50 years can be reasonably expected.

PERFORMANCE

Metalcraft MSS Purlins and Girts, MC Sections, Bracing Systems and MS Tophats are accurately roll-formed from the specified grade of steel, thus ensuring that they achieve the stated performance.

Load capacities in the tables have been established by calculations in accordance with AS/NSZ 4600:2005 "Cold Formed Steel Structures".

Sections chosen using the data provided in the tables will perform as specified when the design, fabrication and erection are carried out in accordance with Metalcraft recommendations and good trade practice.

DURABILITY

Metalcraft MSS Purlins and Girts, and MC Sections, Bracing Systems and MS Tophats will meet a service life of up to 50 years, complying with the durability requirements of NZBC Approved Document B2 providing they are kept free from moisture.

For adverse conditions, including use within 1km of salt marine locations or in severe industrial and unusually corrosive environments, please contact the manufacturer for specialist advice.

Reference documents:

- NZ Steel Durability Statement May 2012.
- Bluescope Steel, technical Bulletin TB-17 (Rev 5, November 2003).

PRODUCT INFORMATION

Metalcraft Roofing require that all information on these products be made available to all sectors of the construction chain to ensure the product is fully maintained and its full life can be realised.

TOLERANCES

All dimensions are nominal, (rolling tolerances to be considered).

Web depth	+ /- 2mm	Flange width	+ /- 2mm
Lip	+ /- 1mm	Length	+ /- 6mm
Hole Centres	+ /- 1.5mm	Web/Flange Angle	88- 93

Metalcraft Roofing have staff freely available to assist in product selection and to comment upon usage prior to projects being started.

TABLES

Tables are supported by Engineers calculations.

ACKNOWLEDGMENT

Both Blueprint Consulting Engineers Ltd and the University of Sydney have assisted in the development of the MSS & MC Purlin System and floor joist and also the production of the manual.

EMC² Ltd has assisted in the development of the Tophat system and production of the manual.

DESIGN CONSIDERATIONS

1.0 AXIAL & FLEXURAL LOADING

1.1 General

MSS Purlins and Girts have been designed to comply with the requirements of AS/NZS 4600:2005 (Cold Formed Steel Structures). Strength Reduction Factors are in accordance with 1.6 of the above Code.

ie. Bending $\phi_b = 0.90$
 Axial $\phi_c = 0.85$

The self weight of the purlin is not included in the load tables and should be added along with other dead loads. All loads are ultimate loads for strength calculations, and serviceability loads for deflection calculations, all in accordance with AS/NZS 1170.

1.2 Vertical loads on purlins

The load span tables show $\phi_b w_u$ (ultimate uniformly distributed load in kN/m) for establishing the purlin strength. Any other loading format must be specifically designed. The restraints as set out in 2.0. must apply.

w_x (applied uniformly distributed load in kN/m) for maximum inwards and outwards load combinations, (derived from AS/NZS 1170) is required in order to establish the strength requirement for the purlin.

The load span tables also show w_s (serviceability load kN/m) for establishing the purlin stiffness based on deflection at those loads of L/150. The applied serviceability load is required for maximum inwards and outwards load combinations.

1.3 Axial Loads with/without Flexure, Symbols

N^*	=	Applied ultimate axial load.
$\phi_c N_{UC}$	=	$0.85 N_{UC}$ = The member capacity in compression (kN).
w_x (kN/m)	=	Applied uniformly distributed ultimate load
$\phi_b w_u$	=	Maximum U.D.L (ultimate) from the tables.
ϕ_b	=	0.9 (strength reduction factor in bending).
C_{mx}	=	1.0 For both ends unrestrained. (Ref. AS/NZS 4600:1996 clause 3.5.1)
α_{rx}	=	$1 - \left(\frac{N^*}{N_e} \right)$
N_e	=	Elastic buckling load about the bending axis.

1.4 Axial loads only

The member capacity in compression = $\phi_c N_{UC}$ from the axial load tables.

1.4.1 Axial load and bending

$\phi_c N_{UC}$ must be determined for the level of restraint provide ie. (a) 1,2 or 3 lateral braces.

For bending about the major axis (X axis) the interaction equation below applies:

$$\frac{N^*}{\phi_c N_{UC}} + \left(\frac{C_{mx}}{\phi_b w_u} \right) \left(\frac{w_x}{\alpha_{rx}} \right) \leq 1.0 \text{ applies}$$

1.4.2 Bending

For bending about the minor axis, (y axis) and for bi-axial bending, calculations from first principles must be carried out.

1.5 Braces

The standard bracing channel is limited to a purlin spacing of 3000mm.

2.0 RESTRAINT

2.1 General

The following restraints are required to achieve the tabulated loads.

2.2 Roof Purlins with uniformly distributed loading

One flange of purlin to have roof cladding with normal screw fixings. Providing minor axis rotation restraint of 200000 Nmm/mm.

Compression flange not restrained by roof sheeting to be restrained by lateral braces as shown in the tables. For pitches over 10° the resultant forces in the plane of the roof must be allowed for.

2.3 Girts with horizontal loading

Vertical loads are carried by the bracing system, connected to primary structure capable of supporting the vertical load. A maximum brace spacing of 3000mm with sheeting screw fixed to the girts provided minor axis rotation restraint of 200000 Nmm/mm.

2.4 Roof Purlins with combined axial load and bending

Restraint by braces with roof sheeting to one flange is required.

2.5 Columns Axial Load only

Restraint as selected for the relevant $\phi_c N_{UC}$ value adopted from the tables.

2.6 Combined Axial and bending

As noted in 2.4 above but the level of restraint applicable must be determined.

MSS & MC DESIGN & SELECTION

These Tables have been prepared on the following basis:

- Roof sheeting screw fixed to the top flange.
- The self weight of the purlin is not included in the load tables.
- All spans for continuous lapped members and double lapped spans are assumed to be equal.
- These tables are for use by structural engineers and it is assumed they will derive linear loads “inwards” and “outwards” on members.
- Standard bracing channel is limited to a purlin spacing of 3000mm.
- All table capacities refer to uniformly distributed loads.
- Load applied through top flange.

Design Loads calculated for load spans as follows:

- Lap length is the maximum of 10% x span or 600mm.
Minimum bolt size is M16 (G8.8/S).

IMPORTANT

In the design of continuous lapped span members, the specified end span and internal span loads are assumed to act concurrently with all spans loads at specified load capacities.

Design Engineers must be aware that patch loading or situations where applied loads vary from the specified loadings (from this book) in any one or all spans, adequacy of the specified system must be verified by the Design Engineers for compliance with AS4600-2005.

NOTE: Member adequacy is highly dependent on the maximum applied moment and the moment profile within the span.

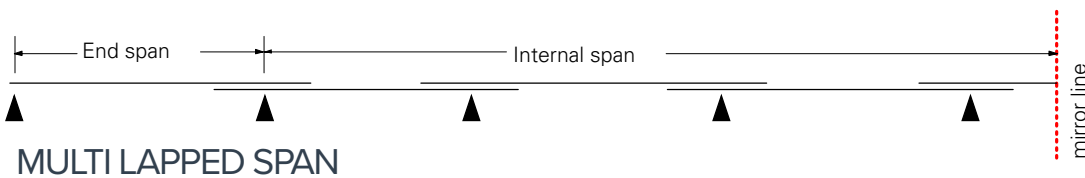

End spans are the minimum capacities from double lapped or triple lapped case.
Internal spans capabilities are corresponding maximum load applied uniformly to all internal bays.

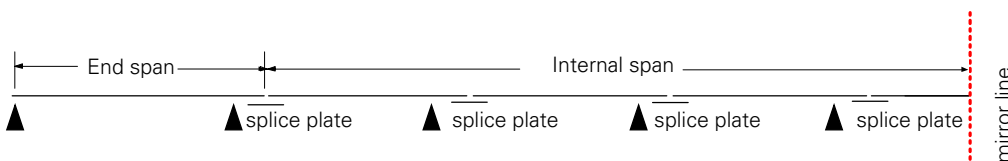

Continuous end spans are the minimum capacities from continuous double or triple cases. Continuous Internal spans capabilities are corresponding maximum load applied uniformly to all continuous internal bays.

MSS & MC DESIGN & SELECTION

PURLINS & GIRTS – SINGLE SPAN

1. SYMBOLS

- w_x = Calculated ultimate load/metre on the purlin (kN/m).
 w_s = Serviceability load/metre on the purlin (kN/m).
 $\phi_b w_u$ = Allowable ultimate load /metre on the purlin (kN/m) from the tables.
 N^* = Ultimate axial load applied to the purlin (kN).
 α_{rx} = $1 - \left(\frac{N^*}{N_e} \right)$
 C_{mx} = 1
 $\phi_c N_{uc}$ = Axial load capacity from the table.
 N_e = Elastic buckling load from the tables.

2. UNIFORMLY DISTRIBUTED LOAD ON ROOF PURLINS

Design Example

Restraints – Screw fixed roofing provides a fully restrained condition for downwards (or inwards) loading. Braces provide lateral restraint for upwards (or outwards) loading.

Span L = 10m
Purlin Spacing = 1.6m

Derived loadings/m on purlins – from known dead load, live load & wind pressure on the roof.

Serviceability $w_s = 0.72 \uparrow = 0.24 \downarrow$
 Calculated Ultimate Load $w_x = 0.89 \uparrow = 0.99 \downarrow$

Serviceability – Maximum deflection \uparrow or $\downarrow = \frac{L}{150}$

Try: 250/15 From load span tables

for 10.0m span $w_s = 0.7$.

Therefore: 250/15 OK.

Ultimate Loads:

Check: 250/15 From load span charts for
 10.0m span & 2 braces $\uparrow \phi_b w_u = 1.24 > 0.89$
 10.0m span & 2 braces $\downarrow \phi_b w_u = 1.32 > 0.99$

Therefore: 250/15 with 2 braces is OK.

3. UNIFORMLY DISTRIBUTED LOAD ON ROOF PURLINS PLUS AXIAL LOAD

Design Example – As in 2. But an axial load extended on the purlin from wind pressure on the end wall of the building.

Span L = 10m simply supported
 Purlin spacing = 1.6m
 Axial load $N^* = 15\text{kN}$
 Ultimate loads = $w_x = 0.89 \uparrow$ $w_x = 0.99 \downarrow$

Try: 250/15 purlin with 3 braces

the interaction equation is

$$\frac{N^*}{\phi_c N_{uc}} + \left(\frac{C_{mx}}{\phi_b w_u} \right) \left(\frac{w_x}{\alpha_{rx}} \right) \leq 1.0$$

				OUTWARD	INWARD
$\frac{N^*}{\phi_c N_{uc}}$	outwards load (from table)	$= \frac{15}{113}$	=	0.132	
$\frac{N^*}{\phi_c N_{uc}}$	outwards load (from table)	$= \frac{15}{113}$	=		0.132
$\frac{C_{mx}}{\phi_b w_u}$	outwards load (from table)	$= \frac{1}{1.32}$	=	0.75	
$\frac{C_{mx}}{\phi_b w_u}$	inwards load (from table)	$= \frac{1}{1.32}$	=		0.75
$\frac{w_x}{\alpha_{rx}} = \frac{w_x}{1 - \left(\frac{N^*}{N_e} \right)}$	outwards load (from table)	$\frac{.89}{1 - \left(\frac{15}{135} \right)}$	=	0.998	
$\frac{w_x}{\alpha_{rx}} = \frac{w_x}{1 - \left(\frac{N^*}{N_e} \right)}$	outwards load (from table)	$\frac{.99}{1 - \left(\frac{15}{135} \right)}$	=		1.1136

for outwards load

$$\frac{N^*}{\phi_c N_{uc}} + \left(\frac{C_{mx}}{\phi_b w_u} \right) \left(\frac{w_x}{\alpha_{rx}} \right) = 0.132 + (0.75 \times 0.998) = 0.8805$$

for inwards load

$$\frac{N^*}{\phi_c N_{uc}} + \left(\frac{C_{mx}}{\phi_b w_u} \right) \left(\frac{w_x}{\alpha_{rx}} \right) = 0.132 + (0.75 \times 1.1136) = 0.9672$$

Therefore: 250/15 purlin with 3 braces is required.

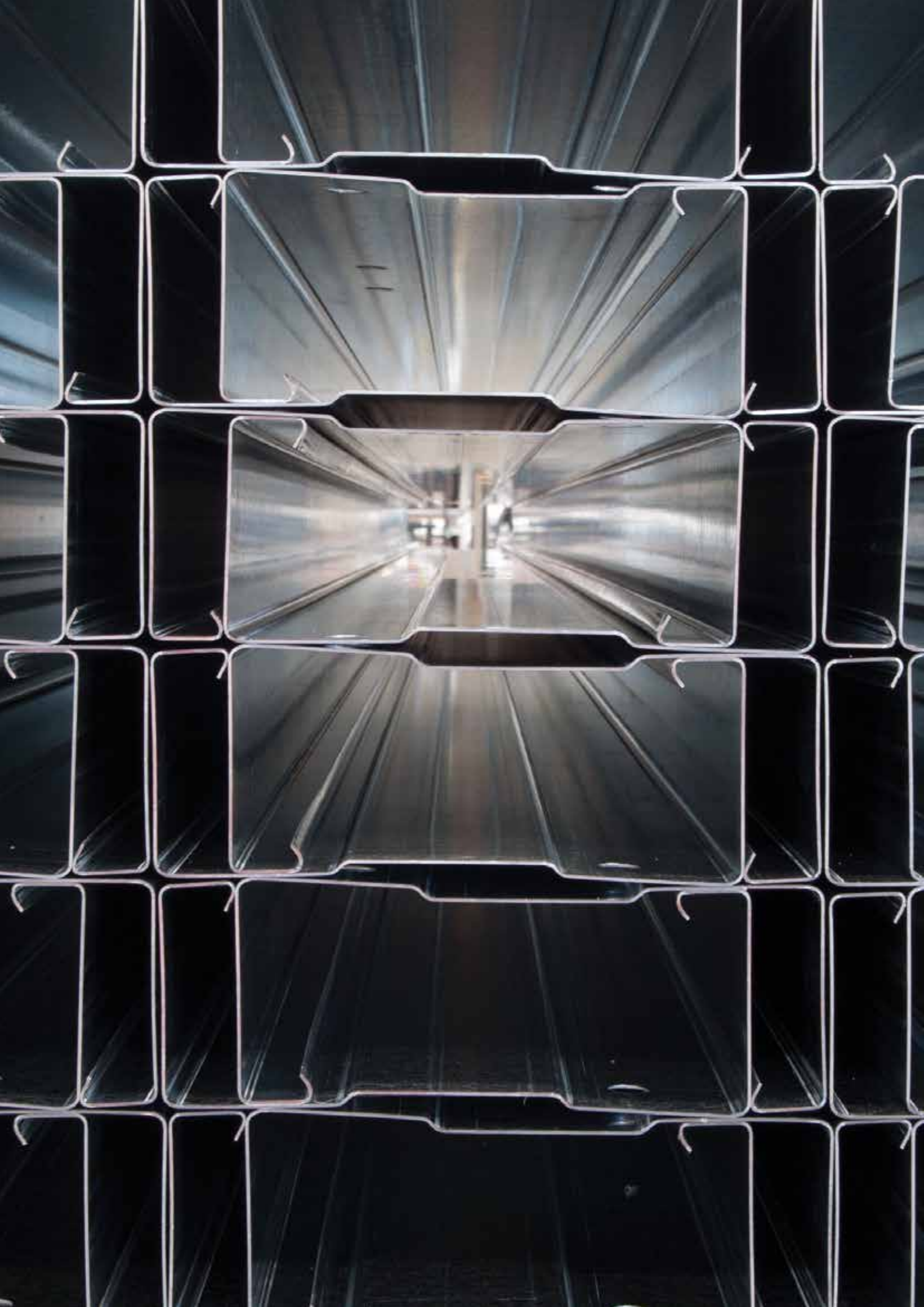

MSS PURLINS

CONTENTS

Product Innovations	14
MSS Section Properties	16
MSS Section Geometry	17
Single Span Guide	18
Single Span	19
Two Span Lapped	34
Three Span Lapped	49
Lapped Multispan (End Span)	64
Lapped Multispan (Internal Spans)	79
Single Span Axial Load Table	94
Two Span Continuous	102
Three Span Continuous	117
Multispan Continuous (End Span)	132
Multispan Continuous (Internal Spans)	147



PRODUCT INNOVATION

Metalcraft Roofing has made a quantum leap forward in product range and manufacturing process with the commissioning and installation of its new purlin machines at the Metalcraft Roofing manufacturing plants in East Tamaki and Christchurch.

There are many great features with the new purlin machine.

The machine is completely automated which means that operator error is reduced as purlin quantities, lengths and punching requirements are handled at the order entry stage.

In comparison to raft based purlin rollformers which require lengthy change over times Metalcraft's purlin machine make the necessary changes in a matter of minutes. The gain in production flexibility allows for improved service levels to the customer. Quality is something that Metalcraft Roofing prides itself on and the new purlin machine has improved production design that ensures that the end product is of the highest quality. Traditional Purlin machines cut the purlin after it has been formed. In order to ensure the purlin is cut and does not flare, older machines will tend to overform the purlin. This means as it passes through the guillotine at the front of the machine the galvanized coating can be shaved on the inner side of the purlin. The Metalcraft Roofing purlin machine overcomes this by cutting the purlin to length before it is rollformed.

Again this is all done by an automated system that means there is less room for error as information is not double handled. To further assist on site the individual purlin data is inkjet printed onto each purlin for ease of identification. Product Innovation is crucial to the success of any industry.

Metalcraft Roofing has innovated by releasing four new purlin sizes unique to the Metalcraft Roofing range:

275/15

275/18

325/15

325/18

MSS SECTION PROPERTIES

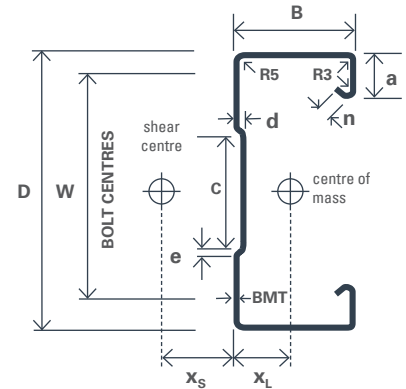

CODE	D x B mm	BMT mm	Mass kg/m	Area mm ²	a mm	n mm	c mm	d mm	e mm	X _s mm	X _L mm	W mm
MSS 150/12	150 x 65	1.15	3.06	390.1	24	11	32.5	4.20	6.0	34.73	24.92	80
MSS 150/15	150 x 65	1.45	3.83	489	24	11	32.5	4.50	6.0	34.27	24.86	80
MSS 150/18	150 x 65	1.75	4.60	586.7	24	11	32.5	4.80	6.0	33.81	24.80	80
MSS 150/23	150 x 65	2.25	5.85	747	24	11	32.5	5.30	6.0	33.05	24.71	80
MSS 200/12	200 x 75	1.15	3.73	475	25	12	69.5	4.20	6.5	36.68	26.43	120
MSS 200/15	200 x 75	1.45	4.68	596.1	25	12	69.5	4.50	6.5	36.23	26.38	120
MSS 200/18	200 x 75	1.75	5.62	716.1	25	12	69.5	4.80	6.5	35.78	26.33	120
MSS 200/23	200 x 75	2.25	7.16	913.3	25	12	69.5	5.30	6.5	35.16	26.21	120
MSS 250/13	250 x 85	1.25	4.91	625.8	33	12	107	6.85	8.0	38.66	29.93	160
MSS 250/15	250 x 85	1.45	5.68	724	33	12	107	7.05	8.0	38.37	29.91	160
MSS 250/18	250 x 85	1.75	6.82	870.4	33	12	107	7.35	8.0	37.92	29.86	160
MSS 250/23	250 x 85	2.25	8.71	1112	33	12	107	7.85	8.0	37.18	29.79	160
MSS 275/15	275 x 90	1.45	6.08	774.7	33	12	130	7.05	8.0	39.04	30.66	180
MSS 275/18	275 x 90	1.75	7.31	931.6	33	12	130	7.35	8.0	38.59	30.62	180
MSS 300/15	300 x 100	1.45	6.69	851.1	37	12	146	7.05	9.0	44.21	34.11	200
MSS 300/18	300 x 100	1.75	8.04	1024	37	12	146	7.35	9.0	43.77	34.07	200
MSS 300/23	300 x 100	2.25	10.27	1309	37	12	146	7.85	9.0	43.03	34.00	200
MSS 300/24	300 x 100	2.4	10.91	1394	37	12	146	8.00	9.0	42.80	33.97	200
MSS 300/30	300 x 100	3.00	13.56	1703	37	12	146	8.55	9.0	41.96	33.91	200
MSS 325/15	325 x 100	1.45	6.97	887.4	37	12	150	7.05	9.0	43.17	32.79	220
MSS 325/18	325 x 100	1.75	8.38	1068	37	12	150	7.35	9.0	42.74	32.75	220
MSS 350/18	350 x 100	1.75	8.89	1132	43	12	179	7.35	9.0	43.09	32.99	240
MSS 350/23	350 x 100	2.25	11.15	1449	43	12	179	7.85	9.0	42.37	32.94	240
MSS 350/24	350 x 100	2.4	12.10	1543	43	12	179	8.00	9.0	42.15	32.92	240
MSS 350/30	350 x 100	3.00	14.78	1886	43	12	179	8.55	9.0	41.33	32.88	240
MSS 400/20	400 x 100	1.95	10.80	1376	48	12	227	7.55	9.0	41.49	32.04	280
MSS 400/23	400 x 100	2.25	12.43	1584	48	12	227	7.85	9.0	41.06	32.01	280
MSS 400/24	400 x 100	2.4	13.24	1687	48	12	227	8.00	9.0	40.85	32.00	280
MSS 400/30	400 x 100	3.00	16.44	2063	48	12	227	8.55	9.0	40.05	31.98	280

MSS SECTION GEOMETRY

CODE	AREA mm ²	SECOND MOMENT OF AREA (x10 ⁶ mm ⁴)		SECTION MODULUS (x10 ³ mm ³)		RADIUS OF GYRATION mm		TORSION CONSTANT (mm ⁴)	WARPING FACTOR (x10 ⁹ mm ⁶)	BENDING STRESS MPa		COMPRESSION STRESS MPa		β _y (x10 ⁶ mm ⁴)
		I _x	I _y	Z _x	Z _y	r _x	r _y	J	I _w	FOL	FOD	FOL	FOD	
MSS 150/12	390.10	1.37	0.256	18.37	6.49	59.2	25.6	171.9	1.588	348.8	423.9	224.9	199.1	167.40
MSS 150/15	489.00	1.71	0.318	22.98	8.06	59.1	25.5	342.7	1.946	550.1	542.2	291.4	254.8	166.80
MSS 150/18	586.70	2.04	0.377	27.50	9.58	59.0	25.4	599.0	2.281	797.3	664.2	361.8	312.8	166.30
MSS 150/23	747.00	2.58	0.471	34.87	12.00	58.7	25.1	1261.0	2.792	1309.0	875.2	489.3	413.6	165.30
MSS 200/12	475.00	2.95	0.400	29.62	8.34	78.7	29.0	209.4	3.930	257.8	303.8	141.7	134.5	209.80
MSS 200/15	596.10	3.68	0.497	37.09	10.38	78.6	28.9	417.8	4.838	406.7	389.1	181.8	172.6	209.40
MSS 200/18	716.10	4.41	0.591	44.45	12.37	78.4	28.7	731.0	5.701	589.2	475.6	223.7	211.7	209.00
MSS 200/23	913.30	5.58	0.742	56.48	15.56	78.2	28.5	1541.0	7.041	959.7	626.7	297.6	279.2	208.60
MSS 250/13	625.80	5.93	0.673	47.65	12.35	97.3	32.8	325.9	10.770	232.5	286.8	145.1	113.4	246.00
MSS 250/15	724.00	6.84	0.775	55.06	14.23	97.2	32.7	507.4	12.330	312.5	335.3	189.9	132.8	245.80
MSS 250/18	870.40	8.20	0.925	66.05	17.00	97.1	32.6	888.5	14.590	454.8	410.6	262.5	162.4	245.50
MSS 250/23	1112.00	10.42	1.166	84.08	21.47	96.8	32.4	1876.0	18.150	751.6	538.2	382.8	213.5	244.90
MSS 275/15	774.70	8.85	0.906	64.69	15.45	106.9	34.2	543.0	16.880	279.0	296.2	128.1	114	269.90
MSS 275/18	931.60	10.61	1.082	77.63	18.47	106.7	34.1	951.0	19.990	406.1	361.8	178.4	139.5	269.60
MSS 300/15	851.10	11.64	1.237	77.96	19.02	116.9	38.1	596.5	27.620	224.4	267.8	103.5	105.3	296.00
MSS 300/18	1024.00	13.96	1.480	93.60	22.76	116.8	38.0	1045.0	32.780	326.9	327.3	144	128.5	296.10
MSS 300/23	1309.00	17.76	1.873	119.30	28.83	116.5	37.8	2209.0	40.980	540.1	428.8	215.2	168.5	295.70
MSS 300/24	1394.00	18.90	1.980	127.00	30.53	116.4	37.7	2676.0	43.330	614.3	463.4	236.2	180.8	295.60
MSS 300/30	1703.00	22.97	2.377	154.70	36.78	116.1	37.4	4939.0	51.610	924.6	577.6	307.2	227	295.10
MSS 325/15	887.40	14.05	1.274	86.84	19.20	125.8	37.9	621.9	32.470	221.8	250.9	97.25	91.02	319.20
MSS 325/18	1068.00	16.86	1.523	104.30	22.97	125.6	37.8	1090.0	38.560	322.8	306.2	134.9	111.1	319.00
MSS 350/18	1132.00	20.41	1.644	117.20	24.87	134.3	38.1	1156.0	49.820	320.8	303.0	98.21	101.4	336.50
MSS 350/23	1449.00	26.00	2.083	149.50	31.55	134.0	37.9	2444.0	62.400	530.1	396.3	148.1	132.8	336.40
MSS 350/24	1543.00	27.65	2.213	159.10	33.52	133.9	37.9	2962.0	66.040	602.9	425.1	163	142.3	336.40
MSS 350/30	1886.00	33.66	2.646	194.00	40.30	133.6	37.5	5470.0	78.870	802.1	532.5	215.4	178.2	336.30
MSS 400/20	1376.00	31.58	1.973	158.70	29.45	151.5	37.9	1744.0	77.700	395.3	302.6	74.12	86.47	383.90
MSS 400/23	1584.00	36.25	2.258	182.30	33.72	151.3	37.8	2672.0	88.380	481.8	352.9	93.84	100.9	384.10
MSS 400/24	1687.00	38.56	2.401	194.00	35.85	151.2	37.7	3238.0	93.510	516.9	378.3	103.9	108.2	384.20
MSS 400/30	2063.00	46.99	2.870	236.70	43.11	150.9	37.3	5983.0	111.800	653.7	474.5	140.4	135.9	384.60

SINGLE SPAN GUIDE

CODE	D x B mm	BMT mm	Mass kg/m	Typical Spans (m) Based on Deflection Limitation only																	
				2	3	4	5	6	7	8	9	10	11	12	13	14	15	16	17	18	
MSS 150/12	150 x 65	1.15	3.06																		
MSS 150/15	150 x 65	1.45	3.83																		
MSS 150/18	150 x 65	1.75	4.60																		
MSS 150/23	150 x 65	2.25	5.85																		
MSS 200/12	200 x 75	1.15	3.73																		
MSS 200/15	200 x 75	1.45	4.68																		
MSS 200/18	200 x 75	1.75	5.62																		
MSS 200/23	200 x 75	2.25	7.16																		
MSS 250/13	250 x 85	1.25	4.91																		
MSS 250/15	250 x 85	1.45	5.68																		
MSS 250/18	250 x 85	1.75	6.82																		
MSS 250/23	250 x 85	2.25	8.71																		
MSS 275/15	275 x 90	1.45	6.08																		
MSS 275/18	275 x 90	1.75	7.31																		
MSS 300/15	300 x 100	1.45	6.69																		
MSS 300/18	300 x 100	1.75	8.04																		
MSS 300/23	300 x 100	2.25	10.27																		
MSS300/30	300 x 100	3.0	10.91																		
MSS 325/15	325 x 100	1.45	13.56																		
MSS 325/18	325 x 100	1.75	6.97																		
MSS 350/18	350 x 100	1.75	8.38																		
MSS350/23	350 x 100	2.25	8.89																		
MSS350/24	350 x 100	2.4	11.15																		
MSS350/30	350 x 100	3.0	12.10																		
MSS 400/20	400 x 100	1.95	14.78																		
MSS 400/23	400 x 100	2.25	10.80																		
MSS 400/24	401 x 100	2.4	12.43																		
MSS 400/30	400 x 100	3.0	13.24																		

NOTE: This chart is for quick reference only. Each situation should be considered separately and designed using standard procedures.
FOR FURTHER INFORMATION AND ORDERS CONTACT METALCRAFT ROOFING

This chart is based on simple single span conditions with criteria determined by:

$w_x = 1.0\text{kN/m}$

$w_s = 0.5\text{kN/m}$ for span/150 deflection limit

Using continuous span arrangement will allow greater span lengths.

Purlin spacing and wind zone will impact purlin selection.

This table is approximately equivalent to medium wind zone with single span purlins at 1.2m c/c with light roof only.

SINGLE SPAN

LOAD TABLE – Uniformly Distributed Load

MSS 150/12								
SPAN (m)	INWARDS				OUTWARDS			
	$\phi_b w_u$ kN/m			W_s kN/m	$\phi_b w_u$ kN/m			W_s kN/m
	1B	2B	3B		1B	2B	3B	
3.0	5.48	5.48	5.48	5.20	5.48	5.48	5.48	5.20
3.5	4.03	4.03	4.03	3.27	4.03	4.03	4.03	3.27
4.0	3.08	3.08	3.08	2.19	3.08	3.08	3.08	2.19
4.5	2.44	2.44	2.44	1.54	2.44	2.44	2.44	1.54
5.0	1.97	1.97	1.97	1.12	1.90	1.97	1.97	1.12
5.5	1.63	1.63	1.63	0.84	1.50	1.63	1.63	0.84
6.0	1.37	1.37	1.37	0.65	1.17	1.37	1.37	0.65
6.5	1.17	1.17	1.17	0.51	0.92	1.17	1.17	0.51
7.0	1.01	1.01	1.01	0.41	0.71	0.99	1.01	0.41
7.5	0.88	0.88	0.88	0.33	0.56	0.84	0.88	0.33
8.0	0.77	0.77	0.77	0.27	0.44	0.71	0.77	0.27
8.5	0.68	0.68	0.68	0.23	0.35	0.60	0.68	0.23
9.0	0.61	0.61	0.61	0.19	0.29	0.51	0.61	0.19
9.5	0.55	0.55	0.55	0.16	0.23	0.43	0.54	0.16
10.0	0.49	0.49	0.49	0.14	0.19	0.37	0.47	0.14
10.5	0.45	0.45	0.45	0.12	0.16	0.31	0.42	0.12
11.0	0.41	0.41	0.41	0.11	0.13	0.26	0.37	0.11
11.5								
12.0								
12.5								
13.0								
13.5								
14.0								
14.5								
15.0								
15.5								
16.0								
16.5								
17.0								
17.5								
18.0								
ϕM_s kNm	7.11				7.11			
$\phi_v V_v$ kN	31.75				31.75			

MSS 150/15								
SPAN (m)	INWARDS				OUTWARDS			
	$\phi_b w_u$ kN/m			W_s kN/m	$\phi_b w_u$ kN/m			W_s kN/m
	1B	2B	3B		1B	2B	3B	
3.0	7.49	7.49	7.49	6.49	7.49	7.49	7.49	6.49
3.5	5.51	5.51	5.51	4.08	5.51	5.51	5.51	4.08
4.0	4.21	4.21	4.21	2.74	4.21	4.21	4.21	2.74
4.5	3.33	3.33	3.33	1.92	3.33	3.33	3.33	1.92
5.0	2.70	2.70	2.70	1.40	2.60	2.70	2.70	1.40
5.5	2.23	2.23	2.23	1.05	2.02	2.23	2.23	1.05
6.0	1.87	1.87	1.87	0.81	1.58	1.87	1.87	0.81
6.5	1.60	1.60	1.60	0.64	1.23	1.60	1.60	0.64
7.0	1.38	1.38	1.38	0.51	0.96	1.36	1.38	0.51
7.5	1.20	1.20	1.20	0.42	0.74	1.14	1.20	0.42
8.0	1.05	1.05	1.05	0.34	0.58	0.96	1.05	0.34
8.5	0.93	0.93	0.93	0.29	0.46	0.81	0.93	0.29
9.0	0.83	0.83	0.83	0.24	0.37	0.69	0.83	0.24
9.5	0.75	0.75	0.75	0.20	0.30	0.58	0.73	0.20
10.0	0.67	0.67	0.67	0.18	0.25	0.49	0.64	0.18
10.5	0.61	0.61	0.61	0.15	0.20	0.41	0.57	0.15
11.0	0.56	0.56	0.56	0.13	0.17	0.35	0.50	0.13
11.5								
12.0								
12.5								
13.0								
13.5								
14.0								
14.5								
15.0								
15.5								
16.0								
16.5								
17.0								
17.5								
18.0								
ϕM_s kNm	10.05				10.05			
$\phi_v V_v$ kN	45.95				45.95			

- 1B = One mid span brace
- 2B = Two equally spaced braces within the span
- 3B = Three equally spaced braces within the span
- w_s = Uniformly distributed serviceability load (kN/m) for deflection limit of Span/150
- $\phi_b w_u$ = Strength load resistance applied at the centroid (kN/m)

- 2-M12 Grade 4.6 bolts per connection
- 2-M12 Grade 8.8 bolts per connection
- 2-M16 Grade 4.6 bolts per connection
- 2-M16 Grade 8.8 bolts per connection

SINGLE SPAN

LOAD TABLE – Uniformly Distributed Load

MSS 150/18								
SPAN (m)	INWARDS				OUTWARDS			
	$\phi_b w_u$ kN/m			Ws kN/m	$\phi_b w_u$ kN/m			Ws kN/m
	1B	2B	3B		1B	2B	3B	
3.0	8.95	8.95	8.95	7.74	8.95	8.95	8.95	7.74
3.5	6.58	6.58	6.58	4.87	6.58	6.58	6.58	4.87
4.0	5.03	5.03	5.03	3.26	5.03	5.03	5.03	3.26
4.5	3.98	3.98	3.98	2.29	3.97	3.98	3.98	2.29
5.0	3.22	3.22	3.22	1.67	3.07	3.22	3.22	1.67
5.5	2.66	2.66	2.66	1.26	2.40	2.66	2.66	1.26
6.0	2.24	2.24	2.24	0.97	1.88	2.24	2.24	0.97
6.5	1.91	1.91	1.91	0.76	1.48	1.91	1.91	0.76
7.0	1.64	1.64	1.64	0.61	1.16	1.60	1.64	0.61
7.5	1.43	1.43	1.43	0.50	0.90	1.35	1.43	0.50
8.0	1.26	1.26	1.26	0.41	0.70	1.14	1.26	0.41
8.5	1.12	1.12	1.12	0.34	0.56	0.97	1.12	0.34
9.0	0.99	0.99	0.99	0.29	0.45	0.82	0.99	0.29
9.5	0.89	0.89	0.89	0.24	0.36	0.70	0.87	0.24
10.0	0.80	0.81	0.81	0.21	0.30	0.59	0.76	0.21
10.5	0.73	0.73	0.73	0.18	0.25	0.50	0.67	0.18
11.0	0.66	0.67	0.67	0.16	0.21	0.42	0.59	0.16
11.5								
12.0								
12.5								
13.0								
13.5								
14.0								
14.5								
15.0								
15.5								
16.0								
16.5								
17.0								
17.5								
18.0								
ϕM_s kNm	11.62				11.62			
$\phi_v V_v$ kN	58.78				58.78			

MSS 150/23								
SPAN (m)	INWARDS				OUTWARDS			
	$\phi_b w_u$ kN/m			Ws kN/m	$\phi_b w_u$ kN/m			Ws kN/m
	1B	2B	3B		1B	2B	3B	
3.0	12.3	12.3	12.3	9.78	12.3	12.3	12.3	9.78
3.5	9.06	9.06	9.06	6.16	9.06	9.06	9.06	6.16
4.0	6.93	6.93	6.93	4.13	6.77	6.93	6.93	4.13
4.5	5.48	5.48	5.48	2.90	5.11	5.48	5.48	2.90
5.0	4.38	4.44	4.44	2.11	3.92	4.44	4.44	2.11
5.5	3.57	3.67	3.67	1.59	3.05	3.66	3.67	1.59
6.0	2.96	3.08	3.08	1.22	2.39	2.99	3.08	1.22
6.5	2.49	2.63	2.63	0.96	1.88	2.47	2.63	0.96
7.0	2.12	2.26	2.26	0.77	1.48	2.06	2.26	0.77
7.5	1.83	1.97	1.97	0.63	1.16	1.73	1.96	0.63
8.0	1.60	1.72	1.73	0.52	0.91	1.46	1.68	0.52
8.5	1.40	1.51	1.54	0.43	0.73	1.23	1.46	0.43
9.0	1.24	1.34	1.37	0.36	0.59	1.05	1.27	0.36
9.5	1.11	1.19	1.23	0.31	0.48	0.89	1.11	0.31
10.0	0.99	1.07	1.11	0.26	0.40	0.76	0.97	0.26
10.5	0.89	0.96	1.00	0.23	0.33	0.64	0.86	0.23
11.0	0.81	0.87	0.91	0.20	0.28	0.54	0.75	0.20
11.5								
12.0								
12.5								
13.0								
13.5								
14.0								
14.5								
15.0								
15.5								
16.0								
16.5								
17.0								
17.5								
18.0								
ϕM_s kNm	15.14				15.14			
$\phi_v V_v$ kN	79.02				79.02			

- 1B = One mid span brace
- 2B = Two equally spaced braces within the span
- 3B = Three equally spaced braces within the span
- w_s = Uniformly distributed serviceability load (kN/m) for deflection limit of Span/150
- $\phi_b w_u$ = Strength load resistance applied at the centroid (kN/m)

- 2-M12 Grade 4.6 bolts per connection
- 2-M12 Grade 8.8 bolts per connection
- 2-M16 Grade 4.6 bolts per connection
- 2-M16 Grade 8.8 bolts per connection

SINGLE SPAN

LOAD TABLE – Uniformly Distributed Load

MSS 200/12								
SPAN (m)	INWARDS				OUTWARDS			
	$\phi_b w_u$ kN/m			W_s kN/m	$\phi_b w_u$ kN/m			W_s kN/m
	1B	2B	3B		1B	2B	3B	
3.0	7.78	7.78	7.78	11.19	7.78	7.78	7.78	11.19
3.5	5.71	5.71	5.71	7.05	5.71	5.71	5.71	7.05
4.0	4.37	4.37	4.37	4.72	4.37	4.37	4.37	4.72
4.5	3.46	3.46	3.46	3.32	3.46	3.46	3.46	3.32
5.0	2.80	2.80	2.80	2.42	2.75	2.80	2.80	2.42
5.5	2.31	2.31	2.31	1.82	2.19	2.31	2.31	1.82
6.0	1.94	1.94	1.94	1.40	1.76	1.94	1.94	1.40
6.5	1.66	1.66	1.66	1.10	1.43	1.66	1.66	1.10
7.0	1.43	1.43	1.43	0.88	1.16	1.43	1.43	0.88
7.5	1.24	1.24	1.24	0.72	0.94	1.21	1.24	0.72
8.0	1.09	1.09	1.09	0.59	0.76	1.04	1.09	0.59
8.5	0.97	0.97	0.97	0.49	0.63	0.90	0.97	0.49
9.0	0.86	0.86	0.86	0.41	0.51	0.78	0.86	0.41
9.5	0.78	0.78	0.78	0.35	0.42	0.67	0.77	0.35
10.0	0.70	0.70	0.70	0.30	0.35	0.58	0.68	0.30
10.5	0.63	0.63	0.63	0.26	0.29	0.51	0.61	0.26
11.0	0.58	0.58	0.58	0.23	0.25	0.44	0.54	0.23
11.5	0.53	0.53	0.53	0.20	0.21	0.38	0.49	0.20
12.0	0.49	0.49	0.49	0.17	0.18	0.33	0.44	0.17
12.5	0.45	0.45	0.45	0.15	0.15	0.29	0.39	0.15
13.0	0.41	0.41	0.41	0.14	0.13	0.25	0.35	0.14
13.5	0.38	0.38	0.38	0.12	0.11	0.22	0.32	0.12
14.0	0.36	0.36	0.36	0.11	0.10	0.19	0.29	0.11
14.5	0.33	0.33	0.33	0.10	0.09	0.17	0.26	0.10
15.0	0.31	0.31	0.31	0.09	0.08	0.15	0.23	0.09
15.5								
16.0								
16.5								
17.0								
17.5								
18.0								
ϕM_s kNm	9.88				9.88			
$\phi_v V_v$ kN	22.61				22.61			

MSS 200/15								
SPAN (m)	INWARDS				OUTWARDS			
	$\phi_b w_u$ kN/m			W_s kN/m	$\phi_b w_u$ kN/m			W_s kN/m
	1B	2B	3B		1B	2B	3B	
3.0	10.7	10.7	10.7	14.0	10.7	10.7	10.7	14.0
3.5	7.88	7.88	7.88	8.79	7.88	7.88	7.88	8.79
4.0	6.03	6.03	6.03	5.89	6.03	6.03	6.03	5.89
4.5	4.77	4.76	4.77	4.14	4.77	4.76	4.77	4.14
5.0	3.86	3.86	3.86	3.01	3.86	3.86	3.86	3.01
5.5	3.19	3.19	3.19	2.26	3.19	3.19	3.19	2.26
6.0	2.68	2.68	2.68	1.74	2.60	2.68	2.68	1.74
6.5	2.28	2.28	2.28	1.37	2.11	2.28	2.28	1.37
7.0	1.97	1.97	1.97	1.10	1.68	1.97	1.97	1.10
7.5	1.72	1.72	1.72	0.89	1.34	1.72	1.72	0.89
8.0	1.51	1.51	1.51	0.74	1.06	1.51	1.51	0.74
8.5	1.34	1.34	1.34	0.61	0.85	1.32	1.34	0.61
9.0	1.19	1.19	1.19	0.52	0.68	1.14	1.19	0.52
9.5	1.07	1.07	1.07	0.44	0.56	0.99	1.07	0.44
10.0	0.96	0.96	0.96	0.38	0.46	0.85	0.96	0.38
10.5	0.88	0.88	0.88	0.33	0.38	0.73	0.88	0.33
11.0	0.80	0.80	0.80	0.28	0.32	0.63	0.80	0.28
11.5	0.73	0.73	0.73	0.25	0.27	0.53	0.72	0.25
12.0	0.67	0.67	0.67	0.22	0.23	0.46	0.64	0.22
12.5	0.62	0.62	0.62	0.19	0.19	0.39	0.58	0.19
13.0	0.57	0.57	0.57	0.17	0.17	0.34	0.52	0.17
13.5	0.53	0.53	0.53	0.15	0.14	0.29	0.46	0.15
14.0	0.49	0.49	0.49	0.14	0.13	0.26	0.41	0.14
14.5	0.46	0.46	0.46	0.12	0.11	0.23	0.37	0.12
15.0	0.43	0.43	0.43	0.11	0.10	0.20	0.33	0.11
15.5								
16.0								
16.5								
17.0								
17.5								
18.0								
ϕM_s kNm	14.58				14.58			
$\phi_v V_v$ kN	37.74				37.74			

- 1B = One mid span brace
- 2B = Two equally spaced braces within the span
- 3B = Three equally spaced braces within the span
- w_s = Uniformly distributed serviceability load (kN/m) for deflection limit of Span/150
- $\phi_b w_u$ = Strength load resistance applied at the centroid (kN/m)

- 2-M12 Grade 4.6 bolts per connection
- 2-M12 Grade 8.8 bolts per connection
- 2-M16 Grade 4.6 bolts per connection
- 2-M16 Grade 8.8 bolts per connection

SINGLE SPAN

LOAD TABLE – Uniformly Distributed Load

MSS 200/18								
SPAN (m)	INWARDS				OUTWARDS			
	$\phi_b w_u$ kN/m			W_s kN/m	$\phi_b w_u$ kN/m			W_s kN/m
	1B	2B	3B		1B	2B	3B	
3.0	12.9	12.9	12.9	16.73	12.9	12.9	12.9	16.73
3.5	9.51	9.51	9.51	10.53	9.51	9.51	9.51	10.53
4.0	7.28	7.28	7.28	7.06	7.28	7.28	7.28	7.06
4.5	5.75	5.75	5.75	4.96	5.75	5.75	5.75	4.96
5.0	4.66	4.66	4.66	3.61	4.66	4.66	4.66	3.61
5.5	3.85	3.85	3.85	2.71	3.85	3.85	3.85	2.71
6.0	3.24	3.24	3.24	2.09	3.15	3.24	3.24	2.09
6.5	2.76	2.76	2.76	1.64	2.54	2.76	2.76	1.64
7.0	2.38	2.38	2.38	1.32	2.05	2.38	2.38	1.32
7.5	2.07	2.07	2.07	1.07	1.65	2.07	2.07	1.07
8.0	1.82	1.82	1.82	0.88	1.33	1.82	1.82	0.88
8.5	1.61	1.61	1.61	0.74	1.06	1.61	1.61	0.74
9.0	1.44	1.44	1.44	0.62	0.84	1.39	1.44	0.62
9.5	1.29	1.29	1.29	0.53	0.68	1.20	1.29	0.53
10.0	1.17	1.17	1.17	0.45	0.56	1.03	1.17	0.45
10.5	1.06	1.06	1.06	0.39	0.46	0.89	1.06	0.39
11.0	0.96	0.96	0.96	0.34	0.39	0.77	0.96	0.34
11.5	0.88	0.88	0.88	0.30	0.33	0.67	0.87	0.30
12.0	0.81	0.81	0.81	0.26	0.28	0.57	0.78	0.26
12.5	0.75	0.75	0.75	0.23	0.24	0.49	0.70	0.23
13.0	0.69	0.69	0.69	0.21	0.20	0.42	0.63	0.21
13.5	0.64	0.64	0.64	0.18	0.18	0.36	0.56	0.18
14.0	0.59	0.59	0.59	0.16	0.15	0.31	0.50	0.16
14.5	0.55	0.55	0.55	0.15	0.13	0.27	0.45	0.15
15.0	0.52	0.52	0.52	0.13	0.12	0.24	0.40	0.13
15.5								
16.0								
16.5								
17.0								
17.5								
18.0								
ϕM_s kNm	18.08				18.08			
$\phi_v V_v$ kN	57.56				57.56			

MSS 200/23								
SPAN (m)	INWARDS				OUTWARDS			
	$\phi_b w_u$ kN/m			W_s kN/m	$\phi_b w_u$ kN/m			W_s kN/m
	1B	2B	3B		1B	2B	3B	
3.0	18.1	18.1	18.1	21.2	18.1	18.1	18.1	21.2
3.5	13.3	13.3	13.3	13.3	13.3	13.3	13.3	13.3
4.0	10.2	10.2	10.2	8.93	10.2	10.2	10.2	8.93
4.5	8.03	8.03	8.03	6.27	8.03	8.03	8.03	6.27
5.0	6.51	6.51	6.51	4.57	6.43	6.51	6.51	4.57
5.5	5.38	5.38	5.38	3.43	5.15	5.38	5.38	3.43
6.0	4.52	4.52	4.52	2.65	4.17	4.52	4.52	2.65
6.5	3.82	3.85	3.85	2.08	3.33	3.85	3.85	2.08
7.0	3.27	3.32	3.32	1.67	2.67	3.32	3.32	1.67
7.5	2.83	2.89	2.89	1.35	2.14	2.84	2.89	1.35
8.0	2.46	2.54	2.54	1.12	1.70	2.45	2.54	1.12
8.5	2.17	2.25	2.25	0.93	1.35	2.12	2.25	0.93
9.0	1.92	2.01	2.01	0.78	1.09	1.83	2.01	0.78
9.5	1.71	1.80	1.80	0.67	0.88	1.57	1.80	0.67
10.0	1.54	1.63	1.63	0.57	0.72	1.35	1.60	0.57
10.5	1.39	1.47	1.48	0.49	0.60	1.16	1.43	0.49
11.0	1.26	1.33	1.34	0.43	0.50	1.00	1.28	0.43
11.5	1.14	1.21	1.23	0.38	0.43	0.86	1.15	0.38
12.0	1.05	1.11	1.13	0.33	0.36	0.73	1.03	0.33
12.5	0.96	1.02	1.04	0.29	0.31	0.63	0.92	0.29
13.0	0.88	0.94	0.96	0.26	0.27	0.54	0.82	0.26
13.5	0.81	0.87	0.89	0.23	0.23	0.46	0.73	0.23
14.0	0.75	0.80	0.83	0.21	0.20	0.40	0.65	0.21
14.5	0.69	0.74	0.77	0.19	0.18	0.35	0.58	0.19
15.0	0.65	0.69	0.72	0.17	0.16	0.31	0.52	0.17
15.5								
16.0								
16.5								
17.0								
17.5								
18.0								
ϕM_s kNm	22.84				22.84			
$\phi_v V_v$ kN	89.36				89.36			

- 1B = One mid span brace
- 2B = Two equally spaced braces within the span
- 3B = Three equally spaced braces within the span
- w_s = Uniformly distributed serviceability load (kN/m) for deflection limit of Span/150
- $\phi_b w_u$ = Strength load resistance applied at the centroid (kN/m)

- 2-M12 Grade 4.6 bolts per connection
- 2-M12 Grade 8.8 bolts per connection
- 2-M16 Grade 4.6 bolts per connection
- 2-M16 Grade 8.8 bolts per connection

SINGLE SPAN

LOAD TABLE – Uniformly Distributed Load

MSS 250/13								
SPAN (m)	INWARDS				OUTWARDS			
	$\phi_b w_u$ kN/m			w_s kN/m	$\phi_b w_u$ kN/m			w_s kN/m
	1B	2B	3B		1B	2B	3B	
3.0								
3.5								
4.0	6.85	6.85	6.85	9.49	6.85	6.85	6.85	9.49
4.5	5.41	5.41	5.41	6.66	5.41	5.41	5.41	6.66
5.0	4.39	4.39	4.39	4.86	4.29	4.39	4.39	4.86
5.5	3.62	3.62	3.62	3.65	3.45	3.62	3.62	3.65
6.0	3.03	3.05	3.05	2.81	2.81	3.05	3.05	2.81
6.5	2.57	2.60	2.59	2.21	2.31	2.60	2.59	2.21
7.0	2.20	2.24	2.24	1.77	1.92	2.22	2.24	1.77
7.5	1.90	1.95	1.95	1.44	1.60	1.90	1.95	1.44
8.0	1.66	1.71	1.71	1.19	1.34	1.64	1.71	1.19
8.5	1.46	1.52	1.52	0.99	1.12	1.42	1.52	0.99
9.0	1.30	1.35	1.35	0.83	0.93	1.24	1.35	0.83
9.5	1.16	1.22	1.22	0.71	0.78	1.09	1.20	0.71
10.0	1.04	1.09	1.10	0.61	0.66	0.96	1.07	0.61
10.5	0.94	0.99	0.99	0.52	0.56	0.84	0.96	0.52
11.0	0.85	0.89	0.91	0.46	0.48	0.75	0.86	0.46
11.5	0.78	0.81	0.83	0.40	0.42	0.66	0.77	0.40
12.0	0.71	0.75	0.76	0.35	0.36	0.58	0.70	0.35
12.5	0.65	0.68	0.70	0.31	0.31	0.52	0.63	0.31
13.0	0.60	0.63	0.65	0.28	0.27	0.46	0.57	0.28
13.5	0.56	0.58	0.60	0.25	0.23	0.40	0.52	0.25
14.0	0.52	0.54	0.56	0.22	0.20	0.36	0.48	0.22
14.5	0.48	0.50	0.52	0.20	0.18	0.32	0.43	0.20
15.0	0.45	0.47	0.48	0.18	0.16	0.29	0.40	0.18
15.5	0.42	0.44	0.45	0.16	0.14	0.26	0.36	0.16
16.0	0.39	0.41	0.42	0.15	0.12	0.23	0.33	0.15
16.5	0.37	0.38	0.39	0.14	0.11	0.21	0.30	0.14
17.0	0.35	0.36	0.37	0.12	0.10	0.19	0.27	0.12
17.5								
18.0								
ϕM_s kNm	14.78				14.78			
$\phi_v V_v$ kN	27.13				27.13			

MSS 250/15								
SPAN (m)	INWARDS				OUTWARDS			
	$\phi_b w_u$ kN/m			w_s kN/m	$\phi_b w_u$ kN/m			w_s kN/m
	1B	2B	3B		1B	2B	3B	
3.0								
3.5								
4.0	8.42	8.42	8.42	10.94	8.42	8.42	8.42	10.94
4.5	6.65	6.65	6.65	7.69	6.65	6.65	6.65	7.69
5.0	5.39	5.39	5.39	5.60	5.39	5.39	5.39	5.60
5.5	4.45	4.45	4.45	4.21	4.35	4.45	4.45	4.21
6.0	3.74	3.74	3.74	3.24	3.55	3.74	3.74	3.24
6.5	3.19	3.19	3.19	2.55	2.92	3.19	3.19	2.55
7.0	2.74	2.75	2.75	2.04	2.43	2.75	2.75	2.04
7.5	2.37	2.40	2.40	1.66	2.02	2.40	2.40	1.66
8.0	2.07	2.11	2.11	1.37	1.69	2.07	2.11	1.37
8.5	1.82	1.87	1.87	1.14	1.41	1.80	1.87	1.14
9.0	1.61	1.66	1.66	0.96	1.18	1.57	1.66	0.96
9.5	1.44	1.49	1.49	0.82	0.99	1.37	1.49	0.82
10.0	1.29	1.35	1.35	0.70	0.84	1.21	1.35	0.70
10.5	1.17	1.22	1.22	0.61	0.70	1.07	1.21	0.61
11.0	1.06	1.11	1.11	0.53	0.59	0.94	1.08	0.53
11.5	0.96	1.02	1.02	0.46	0.50	0.84	0.98	0.46
12.0	0.88	0.93	0.94	0.41	0.43	0.74	0.88	0.41
12.5	0.81	0.85	0.86	0.36	0.37	0.66	0.80	0.36
13.0	0.74	0.79	0.80	0.32	0.32	0.58	0.73	0.32
13.5	0.69	0.73	0.74	0.28	0.28	0.51	0.66	0.28
14.0	0.64	0.67	0.69	0.26	0.24	0.46	0.60	0.26
14.5	0.59	0.62	0.64	0.23	0.21	0.41	0.55	0.23
15.0	0.55	0.58	0.60	0.21	0.18	0.36	0.50	0.21
15.5	0.51	0.54	0.56	0.19	0.16	0.32	0.46	0.19
16.0	0.48	0.51	0.52	0.17	0.14	0.29	0.42	0.17
16.5	0.45	0.48	0.49	0.16	0.13	0.25	0.38	0.16
17.0	0.42	0.45	0.46	0.14	0.11	0.23	0.35	0.14
17.5								
18.0								
ϕM_s kNm	18.67				18.67			
$\phi_v V_v$ kN	38.39				38.39			

- 1B = One mid span brace
- 2B = Two equally spaced braces within the span
- 3B = Three equally spaced braces within the span
- w_s = Uniformly distributed serviceability load (kN/m) for deflection limit of Span/150
- $\phi_b w_u$ = Strength load resistance applied at the centroid (kN/m)

- 2-M12 Grade 4.6 bolts per connection
- 2-M12 Grade 8.8 bolts per connection
- 2-M16 Grade 4.6 bolts per connection
- 2-M16 Grade 8.8 bolts per connection

SINGLE SPAN

LOAD TABLE – Uniformly Distributed Load

MSS 250/18								
SPAN (m)	INWARDS				OUTWARDS			
	$\phi_b w_u$ kN/m			W_s kN/m	$\phi_b w_u$ kN/m			W_s kN/m
	1B	2B	3B		1B	2B	3B	
3.0								
3.5								
4.0	10.2	10.2	10.2	13.1	10.2	10.2	10.2	13.1
4.5	8.08	8.08	8.08	9.21	8.08	8.08	8.08	9.21
5.0	6.54	6.54	6.54	6.72	6.54	6.54	6.54	6.72
5.5	5.41	5.41	5.41	5.05	5.41	5.41	5.41	5.05
6.0	4.54	4.54	4.54	3.89	4.54	4.54	4.54	3.89
6.5	3.87	3.87	3.87	3.06	3.81	3.87	3.87	3.06
7.0	3.34	3.34	3.34	2.45	3.18	3.34	3.34	2.45
7.5	2.91	2.91	2.91	1.99	2.67	2.91	2.91	1.99
8.0	2.56	2.56	2.56	1.64	2.24	2.56	2.56	1.64
8.5	2.26	2.26	2.26	1.37	1.86	2.26	2.26	1.37
9.0	2.02	2.02	2.02	1.15	1.55	2.02	2.02	1.15
9.5	1.81	1.81	1.81	0.98	1.28	1.79	1.81	0.98
10.0	1.64	1.64	1.64	0.84	1.06	1.58	1.64	0.84
10.5	1.48	1.48	1.48	0.73	0.88	1.40	1.48	0.73
11.0	1.34	1.35	1.35	0.63	0.74	1.25	1.35	0.63
11.5	1.22	1.24	1.24	0.55	0.63	1.11	1.24	0.55
12.0	1.11	1.14	1.14	0.49	0.53	0.98	1.14	0.49
12.5	1.02	1.05	1.05	0.43	0.45	0.86	1.04	0.43
13.0	0.94	0.97	0.97	0.38	0.39	0.76	0.95	0.38
13.5	0.87	0.90	0.90	0.34	0.33	0.67	0.86	0.34
14.0	0.81	0.83	0.83	0.31	0.29	0.59	0.79	0.31
14.5	0.75	0.78	0.78	0.28	0.25	0.52	0.72	0.28
15.0	0.70	0.73	0.73	0.25	0.22	0.46	0.66	0.25
15.5	0.65	0.68	0.68	0.23	0.20	0.40	0.61	0.23
16.0	0.61	0.64	0.64	0.21	0.17	0.36	0.55	0.21
16.5	0.57	0.60	0.60	0.19	0.15	0.32	0.50	0.19
17.0	0.54	0.57	0.57	0.17				0.17
17.5								
18.0								
ϕM_s kNm	23.68				23.68			
$\phi_v V_v$ kN	59.66				59.66			

MSS 250/23								
SPAN (m)	INWARDS				OUTWARDS			
	$\phi_b w_u$ kN/m			W_s kN/m	$\phi_b w_u$ kN/m			W_s kN/m
	1B	2B	3B		1B	2B	3B	
3.0								
3.5								
4.0	14.3	14.3	14.3	16.7	14.3	14.3	14.3	16.7
4.5	11.3	11.3	11.3	11.7	11.3	11.3	11.3	11.7
5.0	9.17	9.17	9.17	8.54	9.17	9.17	9.17	8.54
5.5	7.58	7.58	7.58	6.41	7.58	7.58	7.58	6.41
6.0	6.37	6.37	6.37	4.94	6.37	6.37	6.37	4.94
6.5	5.43	5.43	5.43	3.89	5.40	5.43	5.43	3.89
7.0	4.68	4.68	4.68	3.11	4.45	4.68	4.68	3.11
7.5	4.08	4.08	4.08	2.53	3.69	4.08	4.08	2.53
8.0	3.58	3.58	3.58	2.08	3.06	3.58	3.58	2.08
8.5	3.17	3.17	3.17	1.74	2.52	3.17	3.17	1.74
9.0	2.83	2.83	2.83	1.46	2.07	2.83	2.83	1.46
9.5	2.52	2.54	2.54	1.24	1.69	2.54	2.54	1.24
10.0	2.25	2.29	2.29	1.07	1.38	2.23	2.29	1.07
10.5	2.02	2.08	2.08	0.92	1.14	1.96	2.08	0.92
11.0	1.82	1.90	1.90	0.80	0.95	1.72	1.90	0.80
11.5	1.65	1.73	1.73	0.70	0.80	1.52	1.73	0.70
12.0	1.50	1.59	1.59	0.62	0.68	1.33	1.59	0.62
12.5	1.37	1.47	1.47	0.55	0.58	1.17	1.47	0.55
13.0	1.26	1.36	1.36	0.49	0.50	1.02	1.34	0.49
13.5	1.16	1.26	1.26	0.43	0.43	0.89	1.21	0.43
14.0	1.07	1.17	1.17	0.39	0.38	0.78	1.10	0.39
14.5	0.99	1.09	1.09	0.35	0.33	0.68	1.00	0.35
15.0	0.92	1.02	1.02	0.32	0.29	0.59	0.91	0.32
15.5	0.85	0.95	0.95	0.29	0.26	0.52	0.83	0.29
16.0	0.80	0.89	0.90	0.26	0.23	0.46	0.75	0.26
16.5	0.74	0.83	0.84	0.24	0.20	0.41	0.68	0.24
17.0	0.70	0.78	0.79	0.22	0.18	0.36	0.62	0.22
17.5								
18.0								
ϕM_s kNm	34.9				34.9			
$\phi_v V_v$ kN	102.24				102.24			

- 1B = One mid span brace
- 2B = Two equally spaced braces within the span
- 3B = Three equally spaced braces within the span
- w_s = Uniformly distributed serviceability load (kN/m) for deflection limit of Span/150
- $\phi_b w_u$ = Strength load resistance applied at the centroid (kN/m)

- 2-M12 Grade 4.6 bolts per connection
- 2-M12 Grade 8.8 bolts per connection
- 2-M16 Grade 4.6 bolts per connection
- 2-M16 Grade 8.8 bolts per connection

SINGLE SPAN

LOAD TABLE – Uniformly Distributed Load

MSS 275/15								
SPAN (m)	INWARDS				OUTWARDS			
	$\phi_b w_u$ kN/m			w_s kN/m	$\phi_b w_u$ kN/m			w_s kN/m
	1B	2B	3B		1B	2B	3B	
3.0								
3.5								
4.0								
4.5	7.45	7.45	7.45	9.95	7.45	7.45	7.45	9.95
5.0	6.03	6.03	6.03	7.25	6.03	6.03	6.03	7.25
5.5	4.99	4.99	4.99	5.45	4.91	4.99	4.99	5.45
6.0	4.19	4.19	4.19	4.20	4.01	4.19	4.19	4.20
6.5	3.57	3.57	3.57	3.30	3.31	3.57	3.57	3.30
7.0	3.06	3.08	3.08	2.64	2.76	3.08	3.08	2.64
7.5	2.64	2.68	2.68	2.15	2.31	2.68	2.68	2.15
8.0	2.30	2.36	2.36	1.77	1.94	2.33	2.36	1.77
8.5	2.02	2.09	2.09	1.48	1.63	2.03	2.09	1.48
9.0	1.79	1.86	1.86	1.24	1.37	1.77	1.86	1.24
9.5	1.60	1.67	1.67	1.06	1.15	1.56	1.67	1.06
10.0	1.43	1.51	1.51	0.91	0.98	1.37	1.51	0.91
10.5	1.29	1.37	1.37	0.78	0.83	1.22	1.36	0.78
11.0	1.17	1.25	1.25	0.68	0.72	1.08	1.22	0.68
11.5	1.07	1.13	1.14	0.60	0.62	0.96	1.10	0.60
12.0	0.97	1.04	1.05	0.52	0.53	0.85	1.00	0.52
12.5	0.89	0.95	0.97	0.46	0.45	0.76	0.91	0.46
13.0	0.82	0.87	0.89	0.41	0.39	0.67	0.82	0.41
13.5	0.76	0.81	0.83	0.37	0.34	0.60	0.75	0.37
14.0	0.70	0.75	0.77	0.33	0.30	0.53	0.68	0.33
14.5	0.65	0.69	0.72	0.30	0.26	0.47	0.62	0.30
15.0	0.61	0.65	0.67	0.27	0.23	0.42	0.57	0.27
15.5	0.57	0.60	0.63	0.24	0.20	0.38	0.52	0.24
16.0	0.53	0.56	0.58	0.22	0.18	0.34	0.48	0.22
16.5	0.50	0.53	0.55	0.20	0.16	0.31	0.44	0.20
17.0	0.47	0.50	0.51	0.18	0.14	0.28	0.40	0.18
17.5								
18.0								
ϕM_s kNm	20.82				20.82			
$\phi_v V_v$ kN	31.08				31.08			

MSS 275/18								
SPAN (m)	INWARDS				OUTWARDS			
	$\phi_b w_u$ kN/m			w_s kN/m	$\phi_b w_u$ kN/m			w_s kN/m
	1B	2B	3B		1B	2B	3B	
3.0								
3.5								
4.0								
4.5	9.06	9.06	9.06	11.9	9.06	9.06	9.06	11.9
5.0	7.34	7.34	7.34	8.69	7.34	7.34	7.34	8.69
5.5	6.06	6.06	6.06	6.53	6.06	6.06	6.06	6.53
6.0	5.09	5.09	5.09	5.03	5.09	5.09	5.09	5.03
6.5	4.34	4.34	4.34	3.96	4.30	4.34	4.34	3.96
7.0	3.74	3.74	3.74	3.17	3.60	3.74	3.74	3.17
7.5	3.26	3.26	3.26	2.58	3.03	3.26	3.26	2.58
8.0	2.87	2.87	2.87	2.12	2.57	2.87	2.87	2.12
8.5	2.54	2.54	2.54	1.77	2.18	2.54	2.54	1.77
9.0	2.26	2.26	2.26	1.49	1.86	2.26	2.26	1.49
9.5	2.03	2.03	2.03	1.27	1.57	2.02	2.03	1.27
10.0	1.82	1.83	1.83	1.09	1.30	1.79	1.83	1.09
10.5	1.64	1.66	1.66	0.94	1.09	1.59	1.66	0.94
11.0	1.48	1.52	1.52	0.82	0.92	1.41	1.52	0.82
11.5	1.35	1.39	1.39	0.71	0.78	1.26	1.39	0.71
12.0	1.23	1.27	1.27	0.63	0.66	1.13	1.27	0.63
12.5	1.13	1.17	1.17	0.56	0.57	1.01	1.17	0.56
13.0	1.04	1.09	1.09	0.49	0.49	0.90	1.07	0.49
13.5	0.96	1.01	1.01	0.44	0.42	0.81	0.98	0.44
14.0	0.89	0.94	0.94	0.40	0.36	0.72	0.89	0.40
14.5	0.83	0.87	0.87	0.36	0.32	0.64	0.82	0.36
15.0	0.77	0.82	0.82	0.32	0.28	0.56	0.75	0.32
15.5	0.72	0.76	0.76	0.29	0.24	0.50	0.69	0.29
16.0	0.67	0.71	0.72	0.27	0.22	0.44	0.64	0.27
16.5	0.63	0.67	0.67	0.24	0.19	0.39	0.58	0.24
17.0	0.59	0.63	0.63	0.22	0.17	0.35	0.54	0.22
17.5								
18.0								
ϕM_s kNm	26.38				26.38			
$\phi_v V_v$ kN	48.64				48.64			

- 1B = One mid span brace
- 2B = Two equally spaced braces within the span
- 3B = Three equally spaced braces within the span
- w_s = Uniformly distributed serviceability load (kN/m) for deflection limit of Span/150
- $\phi_b w_u$ = Strength load resistance applied at the centroid (kN/m)

- 2-M12 Grade 4.6 bolts per connection
- 2-M12 Grade 8.8 bolts per connection
- 2-M16 Grade 4.6 bolts per connection
- 2-M16 Grade 8.8 bolts per connection

SINGLE SPAN

LOAD TABLE – Uniformly Distributed Load

MSS 300/15								
SPAN (m)	INWARDS				OUTWARDS			
	$\phi_b w_u$ kN/m			w_s kN/m	$\phi_b w_u$ kN/m			w_s kN/m
	1B	2B	3B		1B	2B	3B	
3.0								
3.5								
4.0								
4.5								
5.0	6.97	6.97	6.97	9.54	6.97	6.97	6.97	9.54
5.5	5.76	5.76	5.76	7.16	5.76	5.76	5.76	7.16
6.0	4.84	4.84	4.84	5.52	4.78	4.84	4.84	5.52
6.5	4.12	4.12	4.12	4.34	3.98	4.12	4.12	4.34
7.0	3.54	3.56	3.56	3.48	3.34	3.56	3.56	3.48
7.5	3.06	3.10	3.10	2.83	2.82	3.10	3.10	2.83
8.0	2.67	2.72	2.72	2.33	2.40	2.72	2.72	2.33
8.5	2.34	2.41	2.41	1.94	2.05	2.40	2.41	1.94
9.0	2.07	2.15	2.15	1.64	1.75	2.12	2.15	1.64
9.5	1.85	1.93	1.93	1.39	1.50	1.87	1.93	1.39
10.0	1.65	1.74	1.74	1.19	1.28	1.66	1.74	1.19
10.5	1.49	1.58	1.58	1.03	1.09	1.47	1.58	1.03
11.0	1.35	1.44	1.44	0.90	0.93	1.32	1.44	0.90
11.5	1.23	1.31	1.32	0.78	0.80	1.18	1.31	0.78
12.0	1.12	1.20	1.21	0.69	0.70	1.06	1.19	0.69
12.5	1.03	1.10	1.12	0.61	0.61	0.95	1.08	0.61
13.0	0.94	1.01	1.03	0.54	0.53	0.85	0.99	0.54
13.5	0.87	0.93	0.96	0.48	0.47	0.77	0.91	0.48
14.0	0.81	0.86	0.89	0.43	0.42	0.69	0.83	0.43
14.5	0.75	0.80	0.83	0.39	0.37	0.62	0.76	0.39
15.0	0.70	0.75	0.77	0.35	0.32	0.56	0.70	0.35
15.5	0.65	0.70	0.72	0.32	0.29	0.50	0.64	0.32
16.0	0.61	0.65	0.68	0.29	0.25	0.45	0.59	0.29
16.5	0.57	0.61	0.63	0.27	0.23	0.41	0.55	0.27
17.0	0.53	0.57	0.60	0.24	0.20	0.37	0.51	0.24
17.5	0.50	0.54	0.56	0.22	0.18	0.33	0.47	0.22
18.0	0.47	0.51	0.53	0.20	0.16	0.30	0.43	0.20
ϕM_s kNm	23.61				23.61			
$\phi_v V_v$ kN	27.84				27.84			

MSS 300/18								
SPAN (m)	INWARDS				OUTWARDS			
	$\phi_b w_u$ kN/m			w_s kN/m	$\phi_b w_u$ kN/m			w_s kN/m
	1B	2B	3B		1B	2B	3B	
3.0								
3.5								
4.0								
4.5								
5.0	8.50	8.50	8.50	11.4	8.50	8.50	8.50	11.4
5.5	7.02	7.02	7.02	8.59	7.02	7.02	7.02	8.59
6.0	5.90	5.90	5.90	6.62	5.90	5.90	5.90	6.62
6.5	5.03	5.03	5.03	5.21	5.03	5.03	5.03	5.21
7.0	4.34	4.34	4.34	4.17	4.30	4.34	4.34	4.17
7.5	3.78	3.78	3.78	3.39	3.65	3.78	3.78	3.39
8.0	3.32	3.32	3.32	2.79	3.12	3.32	3.32	2.79
8.5	2.94	2.94	2.94	2.33	2.68	2.94	2.94	2.33
9.0	2.62	2.62	2.62	1.96	2.30	2.62	2.62	1.96
9.5	2.33	2.35	2.35	1.67	1.98	2.35	2.35	1.67
10.0	2.09	2.12	2.12	1.43	1.71	2.12	2.12	1.43
10.5	1.88	1.93	1.93	1.23	1.47	1.90	1.93	1.23
11.0	1.70	1.76	1.76	1.07	1.27	1.70	1.76	1.07
11.5	1.55	1.61	1.61	0.94	1.09	1.53	1.61	0.94
12.0	1.41	1.48	1.48	0.83	0.93	1.38	1.48	0.83
12.5	1.29	1.36	1.36	0.73	0.80	1.24	1.36	0.73
13.0	1.19	1.26	1.26	0.65	0.69	1.12	1.26	0.65
13.5	1.10	1.17	1.17	0.58	0.60	1.01	1.17	0.58
14.0	1.01	1.08	1.08	0.52	0.53	0.91	1.07	0.52
14.5	0.94	1.01	1.01	0.47	0.46	0.83	0.98	0.47
15.0	0.87	0.94	0.94	0.42	0.41	0.75	0.91	0.42
15.5	0.82	0.88	0.88	0.38	0.36	0.67	0.84	0.38
16.0	0.76	0.82	0.83	0.35	0.32	0.61	0.77	0.35
16.5	0.71	0.77	0.78	0.32	0.28	0.55	0.72	0.32
17.0	0.67	0.72	0.74	0.29	0.25	0.50	0.66	0.29
17.5	0.63	0.68	0.69	0.27	0.22	0.45	0.61	0.27
18.0	0.59	0.64	0.66	0.25	0.20	0.40	0.57	0.25
ϕM_s kNm	30.29				30.29			
$\phi_v V_v$ kN	43.64				43.64			

- 1B = One mid span brace
- 2B = Two equally spaced braces within the span
- 3B = Three equally spaced braces within the span
- w_s = Uniformly distributed serviceability load (kN/m) for deflection limit of Span/150
- $\phi_b w_u$ = Strength load resistance applied at the centroid (kN/m)

- 2-M12 Grade 4.6 bolts per connection
- 2-M12 Grade 8.8 bolts per connection
- 2-M16 Grade 4.6 bolts per connection
- 2-M16 Grade 8.8 bolts per connection

SINGLE SPAN

LOAD TABLE – Uniformly Distributed Load

MSS 300/23								
SPAN (m)	INWARDS				OUTWARDS			
	$\phi_b w_u$ kN/m			w_s kN/m	$\phi_b w_u$ kN/m			w_s kN/m
	1B	2B	3B		1B	2B	3B	
3.0								
3.5								
4.0								
4.5								
5.0	12.0	12.0	12.0	14.5	12.0	12.0	12.0	14.5
5.5	9.91	9.91	9.91	10.9	9.91	9.91	9.91	10.9
6.0	8.33	8.33	8.33	8.42	8.33	8.33	8.33	8.42
6.5	7.09	7.09	7.09	6.62	7.09	7.09	7.09	6.62
7.0	6.12	6.12	6.12	5.30	6.12	6.12	6.12	5.30
7.5	5.33	5.33	5.33	4.31	5.33	5.33	5.33	4.31
8.0	4.68	4.68	4.68	3.55	4.68	4.68	4.68	3.55
8.5	4.15	4.15	4.15	2.96	3.96	4.15	4.15	2.96
9.0	3.70	3.70	3.70	2.49	3.37	3.70	3.70	2.49
9.5	3.32	3.32	3.32	2.12	2.87	3.32	3.32	2.12
10.0	3.00	3.00	3.00	1.82	2.44	3.00	3.00	1.82
10.5	2.72	2.72	2.72	1.57	2.07	2.72	2.72	1.57
11.0	2.47	2.48	2.48	1.37	1.75	2.48	2.48	1.37
11.5	2.23	2.27	2.27	1.20	1.48	2.27	2.27	1.20
12.0	2.02	2.08	2.08	1.05	1.26	2.05	2.08	1.05
12.5	1.85	1.92	1.92	0.93	1.07	1.83	1.92	0.93
13.0	1.69	1.77	1.77	0.83	0.92	1.64	1.77	0.83
13.5	1.55	1.65	1.65	0.74	0.79	1.47	1.65	0.74
14.0	1.43	1.53	1.53	0.66	0.69	1.32	1.53	0.66
14.5	1.32	1.43	1.43	0.60	0.60	1.18	1.43	0.60
15.0	1.22	1.33	1.33	0.54	0.53	1.06	1.33	0.54
15.5	1.13	1.25	1.25	0.49	0.46	0.95	1.25	0.49
16.0	1.05	1.17	1.17	0.44	0.41	0.84	1.16	0.44
16.5	0.98	1.10	1.10	0.40	0.36	0.75	1.06	0.40
17.0	0.92	1.04	1.04	0.37	0.32	0.67	0.98	0.37
17.5	0.86	0.98	0.98	0.34	0.29	0.60	0.90	0.34
18.0	0.81	0.93	0.93	0.31	0.26	0.54	0.83	0.31
ϕM_s kNm	45.51				45.51			
$\phi_v V_v$ kN	79.84				79.84			

MSS 300/24								
SPAN (m)	INWARDS				OUTWARDS			
	$\phi_b w_u$ kN/m			w_s kN/m	$\phi_b w_u$ kN/m			w_s kN/m
	1B	2B	3B		1B	2B	3B	
3.0								
3.5								
4.0								
4.5								
5.0	13.1	13.1	13.1	15.48	13.1	13.1	13.1	15.48
5.5	10.8	10.8	10.8	11.63	10.8	10.8	10.8	11.63
6.0	9.11	9.11	9.11	8.96	9.11	9.11	9.11	8.96
6.5	7.76	7.76	7.76	7.05	7.76	7.76	7.76	7.05
7.0	6.69	6.69	6.69	5.64	6.69	6.69	6.69	5.64
7.5	5.83	5.83	5.83	4.59	5.83	5.83	5.83	4.59
8.0	5.12	5.12	5.12	3.78	5.03	5.12	5.12	3.78
8.5	4.54	4.54	4.54	3.15	4.27	4.54	4.54	3.15
9.0	4.05	4.05	4.05	2.65	3.64	4.05	4.05	2.65
9.5	3.63	3.63	3.63	2.26	3.10	3.63	3.63	2.26
10.0	3.27	3.28	3.28	1.94	2.63	3.28	3.28	1.94
10.5	2.93	2.98	2.98	1.67	2.23	2.98	2.98	1.67
11.0	2.63	2.71	2.71	1.45	1.89	2.71	2.71	1.45
11.5	2.38	2.48	2.48	1.27	1.58	2.47	2.48	1.27
12.0	2.16	2.28	2.28	1.12	1.34	2.21	2.28	1.12
12.5	1.96	2.10	2.10	0.99	1.14	1.98	2.10	0.99
13.0	1.80	1.94	1.94	0.88	0.98	1.78	1.94	0.88
13.5	1.65	1.80	1.80	0.79	0.85	1.59	1.80	0.79
14.0	1.51	1.67	1.67	0.71	0.73	1.43	1.67	0.71
14.5	1.40	1.56	1.56	0.63	0.64	1.28	1.56	0.63
15.0	1.29	1.46	1.46	0.57	0.56	1.14	1.46	0.57
15.5	1.20	1.37	1.37	0.52	0.49	1.02	1.35	0.52
16.0	1.11	1.28	1.28	0.47	0.44	0.91	1.25	0.47
16.5	1.04	1.20	1.21	0.43	0.39	0.81	1.15	0.43
17.0	0.97	1.13	1.14	0.39	0.35	0.72	1.06	0.39
17.5	0.91	1.05	1.07	0.36	0.31	0.64	0.97	0.36
18.0	0.85	0.99	1.01	0.33	0.28	0.58	0.90	0.33
ϕM_s kNm	50.49				50.49			
$\phi_v V_v$ kN	93.33				93.33			

- 1B = One mid span brace
- 2B = Two equally spaced braces within the span
- 3B = Three equally spaced braces within the span
- w_s = Uniformly distributed serviceability load (kN/m) for deflection limit of Span/150
- $\phi_b w_u$ = Strength load resistance applied at the centroid (kN/m)

- 2-M12 Grade 4.6 bolts per connection
- 2-M12 Grade 8.8 bolts per connection
- 2-M16 Grade 4.6 bolts per connection
- 2-M16 Grade 8.8 bolts per connection

SINGLE SPAN

LOAD TABLE – Uniformly Distributed Load

MSS 300/30								
SPAN (m)	INWARDS				OUTWARDS			
	$\phi_b w_u$ kN/m			w_s kN/m	$\phi_b w_u$ kN/m			w_s kN/m
	1B	2B	3B		1B	2B	3B	
3.0								
3.5								
4.0								
4.5								
5.0	17.2	17.2	17.2	18.8	17.2	17.2	17.2	18.8
5.5	14.3	14.3	14.3	14.1	14.3	14.3	14.3	14.1
6.0	12.0	12.0	12.0	10.9	12.0	12.0	12.0	10.9
6.5	10.2	10.2	10.2	8.56	10.2	10.2	10.2	8.56
7.0	8.80	8.80	8.80	6.86	8.80	8.80	8.80	6.86
7.5	7.66	7.66	7.66	5.58	7.59	7.66	7.66	5.58
8.0	6.74	6.74	6.74	4.59	6.39	6.74	6.74	4.59
8.5	5.93	5.97	5.97	3.83	5.39	5.97	5.97	3.83
9.0	5.18	5.32	5.32	3.23	4.56	5.32	5.32	3.23
9.5	4.56	4.78	4.78	2.74	3.86	4.78	4.78	2.74
10.0	4.03	4.31	4.31	2.35	3.26	4.31	4.31	2.35
10.5	3.58	3.91	3.91	2.03	2.75	3.91	3.91	2.03
11.0	3.20	3.56	3.56	1.77	2.31	3.54	3.56	1.77
11.5	2.88	3.26	3.26	1.55	1.94	3.15	3.26	1.55
12.0	2.59	2.99	2.99	1.36	1.65	2.80	2.99	1.36
12.5	2.35	2.76	2.76	1.20	1.40	2.50	2.76	1.20
13.0	2.13	2.55	2.55	1.07	1.21	2.23	2.55	1.07
13.5	1.95	2.37	2.37	0.96	1.04	1.99	2.37	0.96
14.0	1.78	2.18	2.20	0.86	0.91	1.78	2.20	0.86
14.5	1.64	2.01	2.05	0.77	0.79	1.59	2.05	0.77
15.0	1.51	1.86	1.92	0.70	0.70	1.41	1.88	0.70
15.5	1.39	1.72	1.79	0.63	0.61	1.26	1.72	0.63
16.0	1.29	1.59	1.68	0.57	0.54	1.12	1.58	0.57
16.5	1.19	1.48	1.58	0.52	0.48	0.99	1.45	0.52
17.0	1.11	1.38	1.49	0.48	0.43	0.88	1.33	0.48
17.5	1.03	1.29	1.41	0.44	0.39	0.79	1.22	0.44
18.0	0.96	1.20	1.33	0.40	0.35	0.71	1.12	0.40
ϕM_s kNm	65.8				65.8			
$\phi_v V_v$ kN	153.81				153.81			

MSS 325/15								
SPAN (m)	INWARDS				OUTWARDS			
	$\phi_b w_u$ kN/m			w_s kN/m	$\phi_b w_u$ kN/m			w_s kN/m
	1B	2B	3B		1B	2B	3B	
3.0								
3.5								
4.0								
4.5								
5.0	7.56	7.56	7.56	11.51	7.56	7.56	7.56	11.51
5.5	6.25	6.25	6.25	8.65	6.25	6.25	6.25	8.65
6.0	5.25	5.25	5.25	6.66	5.21	5.25	5.25	6.66
6.5	4.48	4.48	4.48	5.24	4.33	4.48	4.48	5.24
7.0	3.85	3.86	3.86	4.19	3.63	3.86	3.86	4.19
7.5	3.33	3.36	3.36	3.41	3.07	3.36	3.36	3.41
8.0	2.90	2.95	2.95	2.81	2.60	2.95	2.95	2.81
8.5	2.54	2.62	2.62	2.34	2.22	2.62	2.62	2.34
9.0	2.25	2.33	2.33	1.97	1.89	2.30	2.33	1.97
9.5	2.00	2.10	2.10	1.68	1.62	2.03	2.10	1.68
10.0	1.79	1.89	1.89	1.44	1.38	1.80	1.89	1.44
10.5	1.62	1.72	1.72	1.24	1.18	1.60	1.72	1.24
11.0	1.46	1.56	1.56	1.08	1.01	1.43	1.56	1.08
11.5	1.33	1.43	1.43	0.95	0.87	1.28	1.43	0.95
12.0	1.21	1.31	1.31	0.83	0.75	1.15	1.30	0.83
12.5	1.11	1.20	1.21	0.74	0.65	1.03	1.18	0.74
13.0	1.02	1.10	1.12	0.65	0.57	0.92	1.08	0.65
13.5	0.94	1.02	1.04	0.58	0.51	0.83	0.98	0.58
14.0	0.87	0.94	0.96	0.52	0.45	0.75	0.90	0.52
14.5	0.81	0.87	0.90	0.47	0.40	0.67	0.83	0.47
15.0	0.75	0.81	0.84	0.43	0.36	0.60	0.76	0.43
15.5	0.70	0.76	0.79	0.39	0.32	0.54	0.70	0.39
16.0	0.66	0.71	0.74	0.35	0.28	0.48	0.64	0.35
16.5	0.62	0.66	0.69	0.32	0.25	0.44	0.59	0.32
17.0	0.58	0.62	0.65	0.29	0.22	0.39	0.55	0.29
17.5	0.54	0.58	0.61	0.27	0.20	0.36	0.51	0.27
18.0	0.51	0.55	0.57	0.25	0.18	0.33	0.47	0.25
ϕM_s kNm	25.73				25.73			
$\phi_v V_v$ kN	27.16				27.16			

- 1B = One mid span brace
- 2B = Two equally spaced braces within the span
- 3B = Three equally spaced braces within the span
- w_s = Uniformly distributed serviceability load (kN/m) for deflection limit of Span/150
- $\phi_b w_u$ = Strength load resistance applied at the centroid (kN/m)

- 2-M12 Grade 4.6 bolts per connection
- 2-M12 Grade 8.8 bolts per connection
- 2-M16 Grade 4.6 bolts per connection
- 2-M16 Grade 8.8 bolts per connection

SINGLE SPAN

LOAD TABLE – Uniformly Distributed Load

MSS 325/18									
SPAN (m)	INWARDS				OUTWARDS				Ws kN/m
	$\phi_b w_u$ kN/m			Ws kN/m	$\phi_b w_u$ kN/m			Ws kN/m	
	1B	2B	3B		1B	2B	3B		
3.0									
3.5									
4.0									
4.5									
5.0	9.23	9.23	9.23	13.81	9.23	9.23	9.23	13.81	
5.5	7.63	7.63	7.63	10.38	7.63	7.63	7.63	10.38	
6.0	6.41	6.41	6.41	7.99	6.41	6.41	6.41	7.99	
6.5	5.46	5.46	5.46	6.29	5.46	5.46	5.46	6.29	
7.0	4.71	4.71	4.71	5.03	4.67	4.71	4.71	5.03	
7.5	4.10	4.10	4.10	4.09	3.96	4.10	4.10	4.09	
8.0	3.61	3.61	3.61	3.37	3.38	3.61	3.61	3.37	
8.5	3.19	3.19	3.19	2.81	2.90	3.19	3.19	2.81	
9.0	2.84	2.85	2.85	2.37	2.49	2.85	2.85	2.37	
9.5	2.53	2.56	2.56	2.01	2.14	2.56	2.56	2.01	
10.0	2.26	2.31	2.31	1.73	1.84	2.31	2.31	1.73	
10.5	2.04	2.09	2.09	1.49	1.59	2.06	2.09	1.49	
11.0	1.84	1.91	1.91	1.30	1.36	1.85	1.91	1.30	
11.5	1.67	1.75	1.75	1.14	1.18	1.66	1.75	1.14	
12.0	1.53	1.60	1.60	1.00	1.02	1.49	1.60	1.00	
12.5	1.40	1.48	1.48	0.88	0.88	1.34	1.48	0.88	
13.0	1.29	1.37	1.37	0.79	0.76	1.21	1.37	0.79	
13.5	1.18	1.27	1.27	0.70	0.66	1.09	1.27	0.70	
14.0	1.10	1.18	1.18	0.63	0.58	0.99	1.16	0.63	
14.5	1.02	1.10	1.10	0.57	0.51	0.89	1.07	0.57	
15.0	0.94	1.02	1.03	0.51	0.45	0.80	0.98	0.51	
15.5	0.88	0.95	0.96	0.46	0.39	0.73	0.91	0.46	
16.0	0.82	0.89	0.90	0.42	0.35	0.65	0.84	0.42	
16.5	0.77	0.83	0.85	0.38	0.31	0.59	0.78	0.38	
17.0	0.72	0.78	0.80	0.35	0.27	0.54	0.72	0.35	
17.5	0.68	0.73	0.75	0.32	0.24	0.49	0.66	0.32	
18.0	0.64	0.69	0.71	0.30	0.22	0.44	0.62	0.30	
ϕM_s kNm	32.97				32.97				
$\phi_v V_v$ kN	42.45				42.45				

MSS 350/18									
SPAN (m)	INWARDS				OUTWARDS				Ws kN/m
	$\phi_b w_u$ kN/m			Ws kN/m	$\phi_b w_u$ kN/m			Ws kN/m	
	1B	2B	3B		1B	2B	3B		
3.0									
3.5									
4.0									
4.5									
5.0									
5.5									
6.0	7.17	7.17	7.17	9.68	7.17	7.17	7.17	9.68	
6.5	6.11	6.11	6.11	7.61	6.11	6.11	6.11	7.61	
7.0	5.27	5.27	5.27	6.09	5.21	5.27	5.27	6.09	
7.5	4.59	4.59	4.59	4.95	4.44	4.59	4.59	4.95	
8.0	4.03	4.03	4.03	4.08	3.78	4.03	4.03	4.08	
8.5	3.55	3.57	3.57	3.40	3.24	3.57	3.57	3.40	
9.0	3.14	3.19	3.19	2.87	2.79	3.19	3.19	2.87	
9.5	2.80	2.86	2.86	2.44	2.40	2.86	2.86	2.44	
10.0	2.51	2.58	2.58	2.09	2.07	2.57	2.58	2.09	
10.5	2.26	2.34	2.34	1.81	1.79	2.31	2.34	1.81	
11.0	2.04	2.13	2.13	1.57	1.54	2.07	2.13	1.57	
11.5	1.85	1.95	1.95	1.37	1.33	1.85	1.95	1.37	
12.0	1.69	1.79	1.79	1.21	1.15	1.67	1.79	1.21	
12.5	1.54	1.65	1.65	1.07	1.00	1.50	1.65	1.07	
13.0	1.42	1.53	1.53	0.95	0.88	1.36	1.53	0.95	
13.5	1.30	1.41	1.42	0.85	0.77	1.22	1.41	0.85	
14.0	1.21	1.31	1.32	0.76	0.68	1.11	1.30	0.76	
14.5	1.12	1.22	1.23	0.69	0.59	1.00	1.20	0.69	
15.0	1.04	1.13	1.15	0.62	0.52	0.90	1.10	0.62	
15.5	0.97	1.06	1.07	0.56	0.46	0.82	1.02	0.56	
16.0	0.90	0.99	1.01	0.51	0.41	0.74	0.94	0.51	
16.5	0.84	0.92	0.95	0.47	0.36	0.67	0.87	0.47	
17.0	0.79	0.87	0.89	0.43	0.32	0.60	0.80	0.43	
17.5	0.74	0.81	0.84	0.39	0.29	0.55	0.74	0.39	
18.0	0.70	0.76	0.80	0.36	0.26	0.50	0.69	0.36	
ϕM_s kNm	35.72				35.72				
$\phi_v V_v$ kN	35.73				35.73				

- 1B = One mid span brace
- 2B = Two equally spaced braces within the span
- 3B = Three equally spaced braces within the span
- w_s = Uniformly distributed serviceability load (kN/m) for deflection limit of Span/150
- $\phi_b w_u$ = Strength load resistance applied at the centroid (kN/m)

- 2-M12 Grade 4.6 bolts per connection
- 2-M12 Grade 8.8 bolts per connection
- 2-M16 Grade 4.6 bolts per connection
- 2-M16 Grade 8.8 bolts per connection

SINGLE SPAN

LOAD TABLE – Uniformly Distributed Load

MSS 350/23								
SPAN (m)	INWARDS				OUTWARDS			
	$\phi_b w_u$ kN/m			w_s kN/m	$\phi_b w_u$ kN/m			w_s kN/m
	1B	2B	3B		1B	2B	3B	
3.0								
3.5								
4.0								
4.5								
5.0								
5.5								
6.0	10.1	10.1	10.1	12.33	10.1	10.1	10.1	12.33
6.5	8.63	8.63	8.63	9.69	8.63	8.63	8.63	9.69
7.0	7.44	7.44	7.44	7.76	7.44	7.44	7.44	7.76
7.5	6.48	6.48	6.48	6.31	6.48	6.48	6.48	6.31
8.0	5.70	5.70	5.70	5.20	5.63	5.70	5.70	5.20
8.5	5.05	5.05	5.05	4.34	4.83	5.05	5.05	4.34
9.0	4.50	4.50	4.50	3.65	4.16	4.50	4.50	3.65
9.5	4.04	4.04	4.04	3.11	3.59	4.04	4.04	3.11
10.0	3.63	3.63	3.63	2.66	3.11	3.63	3.63	2.66
10.5	3.26	3.31	3.31	2.30	2.65	3.31	3.31	2.30
11.0	2.93	3.01	3.01	2.00	2.25	3.01	3.01	2.00
11.5	2.66	2.76	2.76	1.75	1.90	2.76	2.76	1.75
12.0	2.42	2.53	2.53	1.54	1.62	2.48	2.53	1.54
12.5	2.21	2.33	2.33	1.36	1.38	2.24	2.33	1.36
13.0	2.02	2.16	2.16	1.21	1.18	2.02	2.16	1.21
13.5	1.86	2.00	2.00	1.08	1.02	1.83	2.00	1.08
14.0	1.71	1.86	1.86	0.97	0.88	1.66	1.86	0.97
14.5	1.58	1.73	1.73	0.87	0.77	1.50	1.73	0.87
15.0	1.47	1.62	1.62	0.79	0.67	1.36	1.62	0.79
15.5	1.36	1.52	1.52	0.71	0.59	1.21	1.51	0.71
16.0	1.27	1.43	1.43	0.65	0.52	1.09	1.40	0.65
16.5	1.19	1.33	1.34	0.59	0.46	0.97	1.29	0.59
17.0	1.11	1.25	1.26	0.54	0.41	0.87	1.20	0.54
17.5	1.04	1.17	1.19	0.50	0.37	0.78	1.11	0.50
18.0	0.98	1.10	1.13	0.46	0.33	0.69	1.03	0.46
ϕM_s kNm	54.67				54.67			
$\phi_v V_v$ kN	65.65				65.65			

MSS 350/24								
SPAN (m)	INWARDS				OUTWARDS			
	$\phi_b w_u$ kN/m			w_s kN/m	$\phi_b w_u$ kN/m			w_s kN/m
	1B	2B	3B		1B	2B	3B	
3.0								
3.5								
4.0								
4.5								
5.0								
5.5								
6.0	11.1	11.1	11.1	13.1	11.1	11.1	11.1	13.1
6.5	9.43	9.43	9.43	10.3	9.43	9.43	9.43	10.3
7.0	8.13	8.13	8.13	8.25	8.13	8.13	8.13	8.25
7.5	7.08	7.08	7.08	6.71	7.08	7.08	7.08	6.71
8.0	6.22	6.22	6.22	5.53	6.22	6.22	6.22	5.53
8.5	5.51	5.51	5.51	4.61	5.37	5.51	5.51	4.61
9.0	4.92	4.92	4.92	3.88	4.63	4.92	4.92	3.88
9.5	4.41	4.41	4.41	3.30	3.95	4.41	4.41	3.30
10.0	3.98	3.98	3.98	2.83	3.36	3.98	3.98	2.83
10.5	3.59	3.61	3.61	2.45	2.86	3.61	3.61	2.45
11.0	3.23	3.29	3.29	2.13	2.42	3.29	3.29	2.13
11.5	2.93	3.01	3.01	1.86	2.04	3.01	3.01	1.86
12.0	2.66	2.77	2.77	1.64	1.72	2.76	2.77	1.64
12.5	2.42	2.55	2.55	1.45	1.47	2.49	2.55	1.45
13.0	2.22	2.36	2.36	1.29	1.26	2.25	2.36	1.29
13.5	2.03	2.19	2.19	1.15	1.08	2.03	2.19	1.15
14.0	1.87	2.03	2.03	1.03	0.94	1.82	2.03	1.03
14.5	1.72	1.89	1.89	0.93	0.82	1.63	1.89	0.93
15.0	1.59	1.77	1.77	0.84	0.72	1.46	1.77	0.84
15.5	1.47	1.66	1.66	0.76	0.63	1.31	1.66	0.76
16.0	1.37	1.56	1.56	0.69	0.56	1.17	1.55	0.69
16.5	1.27	1.46	1.46	0.63	0.50	1.04	1.44	0.63
17.0	1.19	1.38	1.38	0.58	0.44	0.93	1.33	0.58
17.5	1.11	1.29	1.30	0.53	0.39	0.83	1.23	0.53
18.0	1.04	1.21	1.23	0.49	0.35	0.74	1.14	0.49
ϕM_s kNm	60.63				60.63			
$\phi_v V_v$ kN	76.81				76.81			

- 1B = One mid span brace
- 2B = Two equally spaced braces within the span
- 3B = Three equally spaced braces within the span
- w_s = Uniformly distributed serviceability load (kN/m) for deflection limit of Span/150
- $\phi_b w_u$ = Strength load resistance applied at the centroid (kN/m)

- 2-M12 Grade 4.6 bolts per connection
- 2-M12 Grade 8.8 bolts per connection
- 2-M16 Grade 4.6 bolts per connection
- 2-M16 Grade 8.8 bolts per connection

SINGLE SPAN

LOAD TABLE – Uniformly Distributed Load

MSS 350/30								
SPAN (m)	INWARDS				OUTWARDS			
	$\phi_b w_u$ kN/m			W_s kN/m	$\phi_b w_u$ kN/m			W_s kN/m
	1B	2B	3B		1B	2B	3B	
3.0								
3.5								
4.0								
4.5								
5.0								
5.5								
6.0	14.6	14.6	14.6	16.0	14.6	14.6	14.6	16.0
6.5	12.4	12.4	12.4	12.6	12.4	12.4	12.4	12.6
7.0	10.7	10.7	10.7	10.0	10.7	10.7	10.7	10.0
7.5	9.35	9.35	9.35	8.17	9.35	9.35	9.35	8.17
8.0	8.21	8.21	8.21	6.73	8.10	8.21	8.21	6.73
8.5	7.28	7.28	7.28	5.61	6.85	7.28	7.28	5.61
9.0	6.46	6.49	6.49	4.73	5.80	6.49	6.49	4.73
9.5	5.67	5.83	5.83	4.02	4.92	5.83	5.83	4.02
10.0	5.01	5.26	5.26	3.45	4.17	5.26	5.26	3.45
10.5	4.45	4.77	4.77	2.98	3.52	4.77	4.77	2.98
11.0	3.97	4.35	4.35	2.59	2.96	4.35	4.35	2.59
11.5	3.56	3.98	3.98	2.27	2.49	3.98	3.98	2.27
12.0	3.20	3.65	3.65	1.99	2.11	3.65	3.65	1.99
12.5	2.89	3.37	3.37	1.76	1.80	3.37	3.37	1.76
13.0	2.62	3.11	3.11	1.57	1.54	2.84	3.11	1.57
13.5	2.39	2.89	2.89	1.40	1.33	2.54	2.89	1.40
14.0	2.18	2.68	2.68	1.26	1.16	2.27	2.68	1.26
14.5	2.00	2.50	2.50	1.13	1.01	2.02	2.50	1.13
15.0	1.84	2.31	2.34	1.02	0.88	1.81	2.34	1.02
15.5	1.69	2.14	2.19	0.93	0.78	1.61	2.18	0.93
16.0	1.56	1.98	2.05	0.84	0.69	1.43	2.00	0.84
16.5	1.45	1.84	1.93	0.77	0.61	1.27	1.84	0.77
17.0	1.34	1.71	1.82	0.70	0.55	1.13	1.69	0.70
17.5	1.25	1.59	1.72	0.64	0.49	1.01	1.55	0.64
18.0	1.16	1.49	1.62	0.59	0.44	0.90	1.43	0.59
ϕM_s kNm	82.59				82.59			
$\phi_v V_v$ kN	127.35				127.35			

MSS 400/20								
SPAN (m)	INWARDS				OUTWARDS			
	$\phi_b w_u$ kN/m			W_s kN/m	$\phi_b w_u$ kN/m			W_s kN/m
	1B	2B	3B		1B	2B	3B	
3.0								
3.5								
4.0								
4.5								
5.0								
5.5								
6.0	9.70	9.70	9.70	15.0	9.70	9.70	9.70	15.0
6.5	8.26	8.26	8.26	11.8	8.26	8.26	8.26	11.8
7.0	7.12	7.12	7.12	9.43	7.09	7.12	7.12	9.43
7.5	6.21	6.21	6.21	7.67	6.04	6.21	6.21	7.67
8.0	5.45	5.45	5.45	6.32	5.18	5.45	5.45	6.32
8.5	4.78	4.83	4.83	5.27	4.47	4.83	4.83	5.27
9.0	4.22	4.31	4.31	4.44	3.87	4.31	4.31	4.44
9.5	3.75	3.87	3.87	3.77	3.34	3.87	3.87	3.77
10.0	3.35	3.49	3.49	3.23	2.88	3.49	3.49	3.23
10.5	3.01	3.17	3.17	2.79	2.48	3.14	3.17	2.79
11.0	2.72	2.89	2.89	2.43	2.14	2.82	2.89	2.43
11.5	2.47	2.64	2.64	2.13	1.84	2.53	2.64	2.13
12.0	2.25	2.42	2.42	1.87	1.60	2.29	2.42	1.87
12.5	2.06	2.23	2.23	1.66	1.39	2.07	2.23	1.66
13.0	1.89	2.07	2.07	1.47	1.22	1.88	2.07	1.47
13.5	1.74	1.91	1.92	1.31	1.08	1.70	1.92	1.31
14.0	1.61	1.76	1.78	1.18	0.94	1.54	1.77	1.18
14.5	1.49	1.63	1.66	1.06	0.82	1.39	1.63	1.06
15.0	1.38	1.52	1.55	0.96	0.72	1.26	1.50	0.96
15.5	1.29	1.41	1.45	0.87	0.63	1.14	1.39	0.87
16.0	1.20	1.32	1.36	0.79	0.56	1.03	1.29	0.79
16.5	1.12	1.23	1.28	0.72	0.49	0.93	1.19	0.72
17.0	1.05	1.16	1.21	0.66	0.44	0.84	1.11	0.66
17.5	0.98	1.09	1.14	0.60	0.39	0.76	1.03	0.60
18.0	0.92	1.02	1.08	0.55	0.35	0.69	0.96	0.55
ϕM_s kNm	48.92				48.92			
$\phi_v V_v$ kN	36.19				36.19			

- 1B = One mid span brace
- 2B = Two equally spaced braces within the span
- 3B = Three equally spaced braces within the span
- w_s = Uniformly distributed serviceability load (kN/m) for deflection limit of Span/150
- $\phi_b w_u$ = Strength load resistance applied at the centroid (kN/m)

- 2-M12 Grade 4.6 bolts per connection
- 2-M12 Grade 8.8 bolts per connection
- 2-M16 Grade 4.6 bolts per connection
- 2-M16 Grade 8.8 bolts per connection

SINGLE SPAN

LOAD TABLE – Uniformly Distributed Load

MSS 400/23								
SPAN (m)	INWARDS				OUTWARDS			
	$\phi_b w_u$ kN/m			w_s kN/m	$\phi_b w_u$ kN/m			w_s kN/m
	1B	2B	3B		1B	2B	3B	
3.0								
3.5								
4.0								
4.5								
5.0								
5.5								
6.0	11.8	11.8	11.8	17.19	11.8	11.8	11.8	17.19
6.5	10.1	10.1	10.1	13.52	10.1	10.1	10.1	13.52
7.0	8.68	8.68	8.68	10.82	8.68	8.68	8.68	10.82
7.5	7.57	7.57	7.57	8.80	7.57	7.57	7.57	8.80
8.0	6.65	6.65	6.65	7.25	6.56	6.65	6.65	7.25
8.5	5.89	5.89	5.89	6.04	5.63	5.89	5.89	6.04
9.0	5.25	5.25	5.25	5.09	4.84	5.25	5.25	5.09
9.5	4.70	4.72	4.72	4.33	4.18	4.72	4.72	4.33
10.0	4.19	4.26	4.26	3.71	3.61	4.26	4.26	3.71
10.5	3.75	3.86	3.86	3.21	3.12	3.86	3.86	3.21
11.0	3.38	3.52	3.52	2.79	2.69	3.52	3.52	2.79
11.5	3.06	3.22	3.22	2.44	2.32	3.22	3.22	2.44
12.0	2.77	2.96	2.96	2.15	1.99	2.89	2.96	2.15
12.5	2.53	2.72	2.72	1.90	1.69	2.61	2.72	1.90
13.0	2.31	2.52	2.52	1.69	1.45	2.35	2.52	1.69
13.5	2.12	2.34	2.34	1.51	1.25	2.13	2.34	1.51
14.0	1.96	2.17	2.17	1.35	1.08	1.93	2.17	1.35
14.5	1.81	2.02	2.02	1.22	0.94	1.74	2.02	1.22
15.0	1.67	1.89	1.89	1.10	0.83	1.58	1.89	1.10
15.5	1.55	1.77	1.77	1.00	0.73	1.43	1.76	1.00
16.0	1.45	1.65	1.66	0.91	0.64	1.29	1.63	0.91
16.5	1.35	1.54	1.56	0.83	0.57	1.17	1.51	0.83
17.0	1.26	1.44	1.47	0.76	0.50	1.06	1.40	0.76
17.5	1.18	1.35	1.39	0.69	0.45	0.95	1.29	0.69
18.0	1.11	1.27	1.31	0.64	0.40	0.85	1.20	0.64
ϕM_s kNm	62.81				62.81			
$\phi_v V_v$ kN	51.52				51.52			

MSS 400/24								
SPAN (m)	INWARDS				OUTWARDS			
	$\phi_b w_u$ kN/m			w_s kN/m	$\phi_b w_u$ kN/m			w_s kN/m
	1B	2B	3B		1B	2B	3B	
3.0								
3.5								
4.0								
4.5								
5.0								
5.5								
6.0	12.9	12.9	12.9	18.28	12.9	12.9	12.9	18.28
6.5	11.0	11.0	11.0	14.38	11.0	11.0	11.0	14.38
7.0	9.49	9.49	9.49	11.5	9.49	9.49	9.49	11.5
7.5	8.27	8.27	8.27	9.36	8.27	8.27	8.27	9.36
8.0	7.27	7.27	7.27	7.71	7.27	7.27	7.27	7.71
8.5	6.44	6.44	6.44	6.43	6.24	6.44	6.44	6.43
9.0	5.74	5.74	5.74	5.42	5.37	5.74	5.74	5.42
9.5	5.15	5.15	5.15	4.61	4.63	5.15	5.15	4.61
10.0	4.61	4.65	4.65	3.95	4.01	4.65	4.65	3.95
10.5	4.12	4.22	4.22	3.41	3.46	4.22	4.22	3.41
11.0	3.71	3.84	3.84	2.97	2.98	3.84	3.84	2.97
11.5	3.35	3.52	3.52	2.60	2.51	3.52	3.52	2.60
12.0	3.04	3.23	3.23	2.29	2.12	3.20	3.23	2.29
12.5	2.77	2.98	2.98	2.02	1.80	2.89	2.98	2.02
13.0	2.53	2.75	2.75	1.80	1.54	2.61	2.75	1.80
13.5	2.32	2.55	2.55	1.60	1.33	2.36	2.55	1.60
14.0	2.14	2.37	2.37	1.44	1.15	2.14	2.37	1.44
14.5	1.97	2.21	2.21	1.30	1.01	1.93	2.21	1.30
15.0	1.83	2.07	2.07	1.17	0.88	1.75	2.07	1.17
15.5	1.69	1.94	1.94	1.06	0.77	1.59	1.94	1.06
16.0	1.57	1.81	1.82	0.96	0.68	1.44	1.80	0.96
16.5	1.47	1.69	1.71	0.88	0.61	1.28	1.67	0.88
17.0	1.37	1.58	1.61	0.80	0.54	1.14	1.55	0.80
17.5	1.28	1.48	1.52	0.74	0.48	1.02	1.43	0.74
18.0	1.20	1.39	1.44	0.68	0.43	0.91	1.33	0.68
ϕM_s kNm	70.4				70.4			
$\phi_v V_v$ kN	60.47				60.47			

- 1B = One mid span brace
- 2B = Two equally spaced braces within the span
- 3B = Three equally spaced braces within the span
- w_s = Uniformly distributed serviceability load (kN/m) for deflection limit of Span/150
- $\phi_b w_u$ = Strength load resistance applied at the centroid (kN/m)

- 2-M12 Grade 4.6 bolts per connection
- 2-M12 Grade 8.8 bolts per connection
- 2-M16 Grade 4.6 bolts per connection
- 2-M16 Grade 8.8 bolts per connection

SINGLE SPAN

LOAD TABLE – Uniformly Distributed Load

MSS 400/30								
SPAN (m)	INWARDS				OUTWARDS			
	$\phi_b w_u$ kN/m			w_s kN/m	$\phi_b w_u$ kN/m			w_s kN/m
	1B	2B	3B		1B	2B	3B	
3.0								
3.5								
4.0								
4.5								
5.0								
5.5								
6.0	17.1	17.1	17.1	22.28	17.1	17.1	17.1	22.28
6.5	14.6	14.6	14.6	17.52	14.6	14.6	14.6	17.52
7.0	12.6	12.6	12.6	14.03	12.6	12.6	12.6	14.03
7.5	11.0	11.0	11.0	11.41	11.0	11.0	11.0	11.41
8.0	9.62	9.62	9.62	9.40	9.62	9.62	9.62	9.40
8.5	8.52	8.52	8.52	7.84	8.39	8.52	8.52	7.84
9.0	7.60	7.60	7.60	6.60	7.11	7.60	7.60	6.60
9.5	6.82	6.82	6.82	5.61	6.03	6.82	6.82	5.61
10.0	6.05	6.16	6.16	4.81	5.11	6.16	6.16	4.81
10.5	5.36	5.59	5.59	4.16	4.32	5.59	5.59	4.16
11.0	4.77	5.09	5.09	3.62	3.64	5.09	5.09	3.62
11.5	4.27	4.66	4.66	3.16	3.06	4.66	4.66	3.16
12.0	3.84	4.28	4.28	2.78	2.59	4.28	4.28	2.78
12.5	3.46	3.94	3.94	2.46	2.20	3.89	3.94	2.46
13.0	3.13	3.64	3.64	2.19	1.89	3.48	3.64	2.19
13.5	2.85	3.38	3.38	1.96	1.63	3.11	3.38	1.96
14.0	2.59	3.14	3.14	1.75	1.41	2.78	3.14	1.75
14.5	2.37	2.93	2.93	1.58	1.23	2.49	2.93	1.58
15.0	2.17	2.74	2.74	1.43	1.08	2.22	2.74	1.43
15.5	2.00	2.56	2.56	1.29	0.95	1.98	2.56	1.29
16.0	1.84	2.39	2.41	1.17	0.84	1.76	2.41	1.17
16.5	1.70	2.22	2.26	1.07	0.75	1.57	2.25	1.07
17.0	1.58	2.06	2.13	0.98	0.66	1.39	2.07	0.98
17.5	1.46	1.92	2.01	0.90	0.59	1.24	1.91	0.90
18.0	1.36	1.79	1.90	0.83	0.53	1.11	1.75	0.83
ϕM_s kNm	98.04				98.04			
$\phi_v V_v$ kN	101.34				101.34			

- 1B = One mid span brace
 2B = Two equally spaced braces within the span
 3B = Three equally spaced braces within the span
 w_s = Uniformly distributed serviceability load (kN/m)
 for deflection limit of Span/150
 $\phi_b w_u$ = Strength load resistance applied at the
 centroid (kN/m)

- 2-M12 Grade 4.6 bolts per connection
- 2-M12 Grade 8.8 bolts per connection
- 2-M16 Grade 4.6 bolts per connection
- 2-M16 Grade 8.8 bolts per connection

TWO SPAN LAPPED

LOAD TABLE – Uniformly Distributed Load

MSS 150/12								
SPAN (m)	INWARDS				OUTWARDS			
	$\phi_b w_u$ kN/m			Ws kN/m	$\phi_b w_u$ kN/m			Ws kN/m
	1B	2B	3B		1B	2B	3B	
3.0	8.38	8.38	8.38	14.66	8.38	8.38	8.38	14.66
3.5	5.71	5.71	5.71	9.08	5.71	5.71	5.71	9.08
4.0	4.17	4.17	4.17	6.00	4.17	4.17	4.17	6.00
4.5	3.15	3.15	3.15	4.16	3.15	3.15	3.15	4.16
5.0	2.49	2.49	2.49	3.01	2.49	2.49	2.49	3.01
5.5	2.02	2.02	2.02	2.24	2.02	2.02	2.02	2.24
6.0	1.66	1.66	1.66	1.56	1.66	1.66	1.66	1.56
6.5	1.41	1.41	1.41	1.23	1.41	1.41	1.41	1.23
7.0	1.22	1.22	1.22	0.98	1.22	1.22	1.22	0.98
7.5	1.06	1.06	1.06	0.80	1.04	1.06	1.06	0.80
8.0	0.93	0.93	0.93	0.66	0.89	0.93	0.93	0.66
8.5	0.83	0.83	0.83	0.55	0.77	0.83	0.83	0.55
9.0	0.74	0.74	0.74	0.46	0.66	0.74	0.74	0.46
9.5	0.66	0.66	0.66	0.39	0.57	0.66	0.66	0.39
10.0	0.60	0.60	0.60	0.34	0.49	0.59	0.60	0.34
10.5	0.54	0.54	0.54	0.29	0.42	0.52	0.54	0.29
11.0	0.48	0.49	0.49	0.25	0.36	0.47	0.49	0.25
11.5								
12.0								
12.5								
13.0								
13.5								
14.0								
14.5								
15.0								
15.5								
16.0								
16.5								
17.0								
17.5								
18.0								

MSS 150/15								
SPAN (m)	INWARDS				OUTWARDS			
	$\phi_b w_u$ kN/m			Ws kN/m	$\phi_b w_u$ kN/m			Ws kN/m
	1B	2B	3B		1B	2B	3B	
3.0	11.5	11.5	11.5	18.30	11.5	11.5	11.5	18.30
3.5	7.81	7.81	7.81	11.33	7.81	7.81	7.81	11.33
4.0	5.70	5.70	5.70	7.48	5.70	5.70	5.70	7.48
4.5	4.30	4.30	4.30	5.20	4.30	4.30	4.30	5.20
5.0	3.41	3.41	3.41	3.75	3.41	3.41	3.41	3.75
5.5	2.76	2.76	2.76	2.80	2.76	2.76	2.76	2.80
6.0	2.27	2.27	2.27	1.95	2.27	2.27	2.27	1.95
6.5	1.93	1.93	1.93	1.53	1.93	1.93	1.93	1.53
7.0	1.67	1.67	1.67	1.23	1.67	1.67	1.67	1.23
7.5	1.45	1.45	1.45	1.00	1.43	1.45	1.45	1.00
8.0	1.28	1.28	1.28	0.82	1.22	1.28	1.28	0.82
8.5	1.13	1.13	1.13	0.69	1.04	1.13	1.13	0.69
9.0	1.01	1.01	1.01	0.58	0.89	1.01	1.01	0.58
9.5	0.90	0.90	0.90	0.49	0.76	0.90	0.90	0.49
10.0	0.81	0.82	0.82	0.42	0.65	0.81	0.82	0.42
10.5	0.72	0.74	0.74	0.36	0.56	0.71	0.74	0.36
11.0	0.65	0.67	0.67	0.32	0.48	0.63	0.67	0.32
11.5								
12.0								
12.5								
13.0								
13.5								
14.0								
14.5								
15.0								
15.5								
16.0								
16.5								
17.0								
17.5								
18.0								

- 1B = One mid span brace
- 2B = Two equally spaced braces within the span
- 3B = Three equally spaced braces within the span
- w_s = Uniformly distributed serviceability load (kN/m) for deflection limit of Span/150
- $\phi_b w_u$ = Strength load resistance applied at the centroid (kN/m)

- 2-M12 Grade 4.6 bolts per connection
- 2-M12 Grade 8.8 bolts per connection
- 2-M16 Grade 4.6 bolts per connection
- 2-M16 Grade 8.8 bolts per connection

IMPORTANT

The adequacy of multispan system is very sensitive to actual applied loads. The stated loads in this table are assumed uniform over the full purlin system. Variations in actual project design loadings over the length of the purlin system must be checked specifically by the designer to verify system adequacy.

TWO SPAN LAPPED

LOAD TABLE – Uniformly Distributed Load

MSS 150/18								
SPAN (m)	INWARDS				OUTWARDS			
	$\phi_b w_u$ kN/m			W _s kN/m	$\phi_b w_u$ kN/m			W _s kN/m
	1B	2B	3B		1B	2B	3B	
3.0	13.7	13.7	13.7	21.8	13.7	13.7	13.7	21.8
3.5	9.33	9.33	9.33	13.5	9.33	9.33	9.33	13.5
4.0	6.81	6.81	6.81	8.93	6.81	6.81	6.81	8.93
4.5	5.14	5.14	5.14	6.20	5.14	5.14	5.14	6.20
5.0	4.07	4.07	4.07	4.48	4.07	4.07	4.07	4.48
5.5	3.29	3.29	3.29	3.33	3.29	3.29	3.29	3.33
6.0	2.71	2.71	2.71	2.33	2.71	2.71	2.71	2.33
6.5	2.31	2.31	2.31	1.83	2.31	2.31	2.31	1.83
7.0	1.99	1.99	1.99	1.47	1.99	1.99	1.99	1.47
7.5	1.73	1.73	1.73	1.19	1.68	1.73	1.73	1.19
8.0	1.52	1.52	1.52	0.98	1.44	1.52	1.52	0.98
8.5	1.35	1.35	1.35	0.82	1.23	1.35	1.35	0.82
9.0	1.19	1.20	1.20	0.69	1.06	1.20	1.20	0.69
9.5	1.05	1.08	1.08	0.59	0.91	1.08	1.08	0.59
10.0	0.94	0.98	0.98	0.50	0.78	0.95	0.98	0.50
10.5	0.84	0.88	0.88	0.43	0.68	0.84	0.88	0.43
11.0	0.75	0.81	0.81	0.38	0.58	0.75	0.81	0.38
11.5								
12.0								
12.5								
13.0								
13.5								
14.0								
14.5								
15.0								
15.5								
16.0								
16.5								
17.0								
17.5								
18.0								

MSS 150/23								
SPAN (m)	INWARDS				OUTWARDS			
	$\phi_b w_u$ kN/m			W _s kN/m	$\phi_b w_u$ kN/m			W _s kN/m
	1B	2B	3B		1B	2B	3B	
3.0	18.9	18.9	18.9	27.61	18.9	18.9	18.9	27.61
3.5	12.8	12.8	12.8	17.09	12.8	12.8	12.8	17.09
4.0	9.38	9.38	9.38	11.29	9.38	9.38	9.38	11.29
4.5	7.08	7.08	7.08	7.84	7.08	7.08	7.08	7.84
5.0	5.61	5.61	5.61	5.66	5.61	5.61	5.61	5.66
5.5	4.52	4.54	4.54	4.22	4.54	4.54	4.54	4.22
6.0	3.67	3.73	3.73	2.94	3.68	3.73	3.73	2.94
6.5	3.08	3.18	3.18	2.32	3.05	3.18	3.18	2.32
7.0	2.62	2.74	2.74	1.85	2.56	2.74	2.74	1.85
7.5	2.25	2.39	2.39	1.51	2.16	2.39	2.39	1.51
8.0	1.95	2.10	2.10	1.24	1.84	2.08	2.10	1.24
8.5	1.70	1.86	1.86	1.04	1.57	1.81	1.86	1.04
9.0	1.50	1.66	1.66	0.87	1.35	1.58	1.66	0.87
9.5	1.33	1.49	1.49	0.74	1.16	1.39	1.49	0.74
10.0	1.18	1.34	1.34	0.64	1.00	1.22	1.33	0.64
10.5	1.05	1.20	1.22	0.55	0.87	1.08	1.19	0.55
11.0	0.94	1.08	1.11	0.48	0.75	0.96	1.06	0.48
11.5								
12.0								
12.5								
13.0								
13.5								
14.0								
14.5								
15.0								
15.5								
16.0								
16.5								
17.0								
17.5								
18.0								

- 1B = One mid span brace
- 2B = Two equally spaced braces within the span
- 3B = Three equally spaced braces within the span
- w_s = Uniformly distributed serviceability load (kN/m) for deflection limit of Span/150
- $\phi_b w_u$ = Strength load resistance applied at the centroid (kN/m)

- 2-M12 Grade 4.6 bolts per connection
- 2-M12 Grade 8.8 bolts per connection
- 2-M16 Grade 4.6 bolts per connection
- 2-M16 Grade 8.8 bolts per connection

IMPORTANT

The adequacy of multispan system is very sensitive to actual applied loads. The stated loads in this table are assumed uniform over the full purlin system. Variations in actual project design loadings over the length of the purlin system must be checked specifically by the designer to verify system adequacy.

TWO SPAN LAPPED

LOAD TABLE – Uniformly Distributed Load

MSS 200/12								
SPAN (m)	INWARDS				OUTWARDS			
	$\phi_b w_u$ kN/m			W_s kN/m	$\phi_b w_u$ kN/m			W_s kN/m
	1B	2B	3B		1B	2B	3B	
3.0	9.7	9.7	9.7	31.6	9.67	9.67	9.67	31.6
3.5	7.20	7.20	7.20	19.5	7.20	7.20	7.20	19.5
4.0	5.56	5.56	5.56	12.91	5.56	5.56	5.56	12.91
4.5	4.38	4.38	4.38	8.97	4.38	4.38	4.38	8.97
5.0	3.54	3.54	3.54	6.47	3.54	3.54	3.54	6.47
5.5	2.86	2.86	2.86	4.82	2.86	2.86	2.86	4.82
6.0	2.35	2.35	2.35	3.37	2.35	2.35	2.35	3.37
6.5	2.01	2.01	2.01	2.65	2.01	2.01	2.01	2.65
7.0	1.73	1.73	1.73	2.12	1.73	1.73	1.73	2.12
7.5	1.51	1.51	1.51	1.72	1.50	1.51	1.51	1.72
8.0	1.32	1.32	1.32	1.42	1.29	1.32	1.32	1.42
8.5	1.17	1.17	1.17	1.18	1.12	1.17	1.17	1.18
9.0	1.05	1.05	1.05	1.00	0.97	1.05	1.05	1.00
9.5	0.93	0.94	0.94	0.85	0.85	0.94	0.94	0.85
10.0	0.83	0.85	0.85	0.73	0.74	0.84	0.85	0.73
10.5	0.75	0.77	0.77	0.63	0.65	0.75	0.77	0.63
11.0	0.68	0.70	0.70	0.55	0.57	0.67	0.70	0.55
11.5	0.61	0.64	0.64	0.48	0.50	0.61	0.64	0.48
12.0	0.56	0.59	0.59	0.42	0.44	0.55	0.59	0.42
12.5	0.51	0.54	0.54	0.37	0.39	0.49	0.54	0.37
13.0	0.46	0.50	0.50	0.33	0.34	0.45	0.49	0.33
13.5	0.42	0.46	0.47	0.30	0.30	0.40	0.45	0.30
14.0	0.39	0.43	0.43	0.26	0.27	0.36	0.41	0.26
14.5	0.36	0.39	0.40	0.24	0.24	0.33	0.38	0.24
15.0	0.33	0.36	0.38	0.22	0.21	0.30	0.35	0.22
15.5								
16.0								
16.5								
17.0								
17.5								
18.0								

MSS 200/15								
SPAN (m)	INWARDS				OUTWARDS			
	$\phi_b w_u$ kN/m			W_s kN/m	$\phi_b w_u$ kN/m			W_s kN/m
	1B	2B	3B		1B	2B	3B	
3.0	15.1	15.1	15.1	39.4	15.1	15.1	15.1	39.4
3.5	11.1	11.1	11.1	24.4	11.1	11.1	11.1	24.4
4.0	8.16	8.16	8.16	16.1	8.16	8.16	8.16	16.1
4.5	6.16	6.16	6.16	11.2	6.16	6.16	6.16	11.2
5.0	4.88	4.88	4.88	8.08	4.88	4.88	4.88	8.08
5.5	3.95	3.95	3.95	6.02	3.95	3.95	3.95	6.02
6.0	3.25	3.25	3.25	4.20	3.25	3.25	3.25	4.20
6.5	2.77	2.77	2.77	3.30	2.77	2.77	2.77	3.30
7.0	2.38	2.38	2.38	2.64	2.38	2.38	2.38	2.64
7.5	2.08	2.08	2.08	2.15	2.08	2.08	2.08	2.15
8.0	1.83	1.83	1.83	1.77	1.83	1.83	1.83	1.77
8.5	1.62	1.62	1.62	1.48	1.62	1.62	1.62	1.48
9.0	1.44	1.44	1.44	1.24	1.43	1.44	1.44	1.24
9.5	1.30	1.30	1.30	1.06	1.25	1.30	1.30	1.06
10.0	1.17	1.17	1.17	0.91	1.09	1.17	1.17	0.91
10.5	1.06	1.06	1.06	0.78	0.95	1.06	1.06	0.78
11.0	0.97	0.97	0.97	0.68	0.83	0.97	0.97	0.68
11.5	0.88	0.88	0.88	0.60	0.72	0.88	0.88	0.60
12.0	0.80	0.81	0.81	0.52	0.63	0.80	0.81	0.52
12.5	0.73	0.75	0.75	0.46	0.54	0.73	0.75	0.46
13.0	0.67	0.69	0.69	0.41	0.47	0.66	0.69	0.41
13.5	0.61	0.64	0.64	0.37	0.41	0.59	0.64	0.37
14.0	0.56	0.60	0.60	0.33	0.36	0.54	0.60	0.33
14.5	0.52	0.56	0.56	0.30	0.32	0.48	0.56	0.30
15.0	0.48	0.52	0.52	0.27	0.28	0.43	0.51	0.27
15.5								
16.0								
16.5								
17.0								
17.5								
18.0								

- 1B = One mid span brace
- 2B = Two equally spaced braces within the span
- 3B = Three equally spaced braces within the span
- w_s = Uniformly distributed serviceability load (kN/m) for deflection limit of Span/150
- $\phi_b w_u$ = Strength load resistance applied at the centroid (kN/m)

- 2-M12 Grade 4.6 bolts per connection
- 2-M12 Grade 8.8 bolts per connection
- 2-M16 Grade 4.6 bolts per connection
- 2-M16 Grade 8.8 bolts per connection

IMPORTANT

The adequacy of multispan system is very sensitive to actual applied loads. The stated loads in this table are assumed uniform over the full purlin system. Variations in actual project design loadings over the length of the purlin system must be checked specifically by the designer to verify system adequacy.

TWO SPAN LAPPED

LOAD TABLE – Uniformly Distributed Load

MSS 200/18								
SPAN (m)	INWARDS				OUTWARDS			
	$\phi_b w_u$ kN/m			W_s kN/m	$\phi_b w_u$ kN/m			W_s kN/m
	1B	2B	3B		1B	2B	3B	
3.0	19.8	19.8	19.8	47.2	19.8	19.8	19.8	47.2
3.5	13.5	13.5	13.5	29.2	13.5	13.5	13.5	29.2
4.0	9.85	9.85	9.85	19.3	9.85	9.85	9.85	19.3
4.5	7.43	7.43	7.43	13.4	7.43	7.43	7.43	13.4
5.0	5.89	5.89	5.89	9.68	5.89	5.89	5.89	9.68
5.5	4.76	4.76	4.76	7.21	4.76	4.76	4.76	7.21
6.0	3.92	3.92	3.92	5.03	3.92	3.92	3.92	5.03
6.5	3.34	3.34	3.34	3.96	3.34	3.34	3.34	3.96
7.0	2.88	2.88	2.88	3.17	2.88	2.88	2.88	3.17
7.5	2.51	2.51	2.51	2.58	2.51	2.51	2.51	2.58
8.0	2.20	2.20	2.20	2.12	2.20	2.20	2.20	2.12
8.5	1.95	1.95	1.95	1.77	1.95	1.95	1.95	1.77
9.0	1.74	1.74	1.74	1.49	1.74	1.74	1.74	1.49
9.5	1.56	1.56	1.56	1.27	1.51	1.56	1.56	1.27
10.0	1.41	1.41	1.41	1.09	1.32	1.41	1.41	1.09
10.5	1.28	1.28	1.28	0.94	1.15	1.28	1.28	0.94
11.0	1.17	1.17	1.17	0.82	1.01	1.17	1.17	0.82
11.5	1.06	1.07	1.07	0.71	0.88	1.07	1.07	0.71
12.0	0.96	0.98	0.98	0.63	0.77	0.98	0.98	0.63
12.5	0.87	0.90	0.90	0.56	0.67	0.88	0.90	0.56
13.0	0.79	0.83	0.83	0.49	0.59	0.80	0.83	0.49
13.5	0.73	0.77	0.77	0.44	0.51	0.72	0.77	0.44
14.0	0.66	0.72	0.72	0.40	0.44	0.65	0.72	0.40
14.5	0.61	0.67	0.67	0.36	0.39	0.59	0.67	0.36
15.0	0.56	0.63	0.63	0.32	0.34	0.53	0.63	0.32
15.5								
16.0								
16.5								
17.0								
17.5								
18.0								

MSS 200/23								
SPAN (m)	INWARDS				OUTWARDS			
	$\phi_b w_u$ kN/m			W_s kN/m	$\phi_b w_u$ kN/m			W_s kN/m
	1B	2B	3B		1B	2B	3B	
3.0	27.1	27.1	27.0	59.7	27.1	27.1	27.0	59.7
3.5	18.8	18.8	18.8	37.0	18.8	18.8	18.8	37.0
4.0	13.8	13.8	13.8	24.4	13.8	13.8	13.8	24.4
4.5	10.4	10.4	10.4	17.0	10.4	10.4	10.4	17.0
5.0	8.22	8.22	8.22	12.2	8.22	8.22	8.22	12.2
5.5	6.65	6.65	6.65	9.12	6.65	6.65	6.65	9.12
6.0	5.47	5.47	5.47	6.37	5.47	5.47	5.47	6.37
6.5	4.66	4.66	4.66	5.01	4.66	4.66	4.66	5.01
7.0	4.02	4.02	4.02	4.01	4.02	4.02	4.02	4.01
7.5	3.48	3.50	3.50	3.26	3.48	3.50	3.50	3.26
8.0	3.03	3.08	3.08	2.69	3.02	3.08	3.08	2.69
8.5	2.66	2.73	2.73	2.24	2.62	2.73	2.73	2.24
9.0	2.35	2.43	2.43	1.89	2.29	2.43	2.43	1.89
9.5	2.09	2.18	2.18	1.60	2.00	2.18	2.18	1.60
10.0	1.87	1.97	1.97	1.38	1.74	1.97	1.97	1.38
10.5	1.68	1.79	1.79	1.19	1.51	1.76	1.79	1.19
11.0	1.51	1.63	1.63	1.03	1.32	1.59	1.63	1.03
11.5	1.36	1.49	1.49	0.90	1.15	1.43	1.49	0.90
12.0	1.23	1.37	1.37	0.80	1.00	1.29	1.37	0.80
12.5	1.12	1.26	1.26	0.70	0.87	1.17	1.26	0.70
13.0	1.02	1.16	1.17	0.63	0.76	1.05	1.15	0.63
13.5	0.92	1.07	1.08	0.56	0.66	0.95	1.06	0.56
14.0	0.84	0.99	1.01	0.50	0.58	0.85	0.97	0.50
14.5	0.77	0.91	0.94	0.45	0.51	0.77	0.89	0.45
15.0	0.71	0.84	0.88	0.41	0.45	0.69	0.82	0.41
15.5								
16.0								
16.5								
17.0								
17.5								
18.0								

- 1B = One mid span brace
- 2B = Two equally spaced braces within the span
- 3B = Three equally spaced braces within the span
- w_s = Uniformly distributed serviceability load (kN/m) for deflection limit of Span/150
- $\phi_b w_u$ = Strength load resistance applied at the centroid (kN/m)

- 2-M12 Grade 4.6 bolts per connection
- 2-M12 Grade 8.8 bolts per connection
- 2-M16 Grade 4.6 bolts per connection
- 2-M16 Grade 8.8 bolts per connection

IMPORTANT

The adequacy of multispan system is very sensitive to actual applied loads. The stated loads in this table are assumed uniform over the full purlin system. Variations in actual project design loadings over the length of the purlin system must be checked specifically by the designer to verify system adequacy.

TWO SPAN LAPPED

LOAD TABLE – Uniformly Distributed Load

MSS 250/13								
SPAN (m)	INWARDS				OUTWARDS			
	$\phi_b w_u$ kN/m			Ws kN/m	$\phi_b w_u$ kN/m			Ws kN/m
	1B	2B	3B		1B	2B	3B	
3.0								
3.5								
4.0	7.70	7.70	7.69	25.96	7.70	7.70	7.69	25.96
4.5	6.14	6.14	6.14	18.03	6.14	6.14	6.14	18.03
5.0	5.05	5.05	5.05	13.02	5.05	5.05	5.05	13.02
5.5	4.20	4.20	4.20	9.69	4.20	4.20	4.20	9.69
6.0	3.54	3.54	3.54	6.77	3.54	3.54	3.54	6.77
6.5	3.06	3.06	3.06	5.32	3.06	3.06	3.06	5.32
7.0	2.68	2.68	2.68	4.26	2.68	2.68	2.68	4.26
7.5	2.33	2.36	2.36	3.46	2.32	2.36	2.36	3.46
8.0	2.03	2.07	2.07	2.85	2.01	2.07	2.07	2.85
8.5	1.78	1.84	1.84	2.38	1.75	1.84	1.84	2.38
9.0	1.57	1.64	1.64	2.00	1.53	1.64	1.64	2.00
9.5	1.40	1.47	1.47	1.70	1.35	1.47	1.47	1.70
10.0	1.25	1.33	1.33	1.46	1.19	1.31	1.33	1.46
10.5	1.13	1.20	1.20	1.26	1.06	1.18	1.20	1.26
11.0	1.02	1.10	1.10	1.10	0.94	1.06	1.10	1.10
11.5	0.92	1.00	1.00	0.96	0.83	0.95	1.00	0.96
12.0	0.84	0.92	0.92	0.85	0.74	0.86	0.92	0.85
12.5	0.77	0.84	0.85	0.75	0.66	0.78	0.84	0.75
13.0	0.70	0.77	0.79	0.67	0.59	0.71	0.77	0.67
13.5	0.64	0.71	0.73	0.59	0.53	0.65	0.70	0.59
14.0	0.59	0.66	0.68	0.53	0.47	0.59	0.65	0.53
14.5	0.55	0.61	0.63	0.48	0.42	0.54	0.60	0.48
15.0	0.50	0.56	0.59	0.43	0.38	0.50	0.55	0.43
15.5	0.47	0.52	0.55	0.39	0.34	0.46	0.51	0.39
16.0	0.43	0.49	0.51	0.36	0.31	0.42	0.47	0.36
16.5	0.40	0.45	0.48	0.33	0.28	0.38	0.44	0.33
17.0	0.37	0.42	0.45	0.30	0.25	0.35	0.41	0.30
17.5								
18.0								

MSS 250/15								
SPAN (m)	INWARDS				OUTWARDS			
	$\phi_b w_u$ kN/m			Ws kN/m	$\phi_b w_u$ kN/m			Ws kN/m
	1B	2B	3B		1B	2B	3B	
3.0								
3.5								
4.0	10.2	10.2	10.2	29.9	10.2	10.2	10.2	29.9
4.5	8.03	8.03	8.03	20.8	8.03	8.03	8.03	20.8
5.0	6.57	6.57	6.57	15.0	6.57	6.57	6.57	15.0
5.5	5.45	5.45	5.45	11.2	5.45	5.45	5.45	11.2
6.0	4.53	4.53	4.53	7.80	4.53	4.53	4.53	7.80
6.5	3.86	3.86	3.86	6.14	3.86	3.86	3.86	6.14
7.0	3.33	3.33	3.33	4.91	3.33	3.33	3.33	4.91
7.5	2.90	2.90	2.90	4.00	2.90	2.90	2.90	4.00
8.0	2.54	2.55	2.55	3.29	2.53	2.55	2.55	3.29
8.5	2.23	2.26	2.26	2.74	2.21	2.26	2.26	2.74
9.0	1.97	2.01	2.01	2.31	1.93	2.01	2.01	2.31
9.5	1.75	1.81	1.81	1.97	1.70	1.81	1.81	1.97
10.0	1.56	1.63	1.63	1.69	1.50	1.63	1.63	1.69
10.5	1.41	1.48	1.48	1.46	1.33	1.48	1.48	1.46
11.0	1.27	1.35	1.35	1.27	1.18	1.33	1.35	1.27
11.5	1.15	1.23	1.23	1.11	1.06	1.21	1.23	1.11
12.0	1.05	1.13	1.13	0.98	0.94	1.09	1.13	0.98
12.5	0.95	1.04	1.04	0.86	0.84	0.99	1.04	0.86
13.0	0.87	0.97	0.97	0.77	0.75	0.90	0.97	0.77
13.5	0.80	0.89	0.90	0.69	0.67	0.82	0.89	0.69
14.0	0.74	0.82	0.83	0.61	0.60	0.75	0.82	0.61
14.5	0.68	0.76	0.78	0.55	0.54	0.69	0.75	0.55
15.0	0.63	0.71	0.73	0.50	0.48	0.63	0.70	0.50
15.5	0.58	0.66	0.68	0.45	0.43	0.58	0.64	0.45
16.0	0.54	0.61	0.64	0.41	0.39	0.53	0.60	0.41
16.5	0.50	0.57	0.60	0.38	0.35	0.49	0.55	0.38
17.0	0.46	0.53	0.56	0.34	0.31	0.45	0.52	0.34
17.5								
18.0								

- 1B = One mid span brace
- 2B = Two equally spaced braces within the span
- 3B = Three equally spaced braces within the span
- w_s = Uniformly distributed serviceability load (kN/m) for deflection limit of Span/150
- $\phi_b w_u$ = Strength load resistance applied at the centroid (kN/m)

- 2-M12 Grade 4.6 bolts per connection
- 2-M12 Grade 8.8 bolts per connection
- 2-M16 Grade 4.6 bolts per connection
- 2-M16 Grade 8.8 bolts per connection

IMPORTANT

The adequacy of multispan system is very sensitive to actual applied loads. The stated loads in this table are assumed uniform over the full purlin system. Variations in actual project design loadings over the length of the purlin system must be checked specifically by the designer to verify system adequacy.

TWO SPAN LAPPED

LOAD TABLE – Uniformly Distributed Load

MSS 250/18								
SPAN (m)	INWARDS				OUTWARDS			
	$\phi_b w_u$ kN/m			w_s kN/m	$\phi_b w_u$ kN/m			w_s kN/m
	1B	2B	3B		1B	2B	3B	
3.0								
3.5								
4.0	13.7	13.7	13.7	35.9	13.7	13.7	13.7	35.9
4.5	10.4	10.4	10.4	24.9	10.4	10.4	10.4	24.9
5.0	8.27	8.27	8.27	18.0	8.27	8.27	8.27	18.0
5.5	6.69	6.69	6.69	13.4	6.69	6.69	6.69	13.4
6.0	5.50	5.50	5.50	9.36	5.50	5.50	5.50	9.36
6.5	4.69	4.69	4.69	7.36	4.69	4.69	4.69	7.36
7.0	4.04	4.04	4.04	5.89	4.04	4.04	4.04	5.89
7.5	3.52	3.52	3.52	4.79	3.52	3.52	3.52	4.79
8.0	3.09	3.09	3.09	3.95	3.09	3.09	3.09	3.95
8.5	2.74	2.74	2.74	3.29	2.74	2.74	2.74	3.29
9.0	2.45	2.45	2.45	2.77	2.45	2.45	2.45	2.77
9.5	2.19	2.19	2.19	2.36	2.19	2.19	2.19	2.36
10.0	1.98	1.98	1.98	2.02	1.96	1.98	1.98	2.02
10.5	1.80	1.80	1.80	1.75	1.74	1.80	1.80	1.75
11.0	1.62	1.64	1.64	1.52	1.55	1.64	1.64	1.52
11.5	1.47	1.50	1.50	1.33	1.39	1.50	1.50	1.33
12.0	1.34	1.38	1.38	1.17	1.25	1.38	1.38	1.17
12.5	1.22	1.27	1.27	1.03	1.11	1.27	1.27	1.03
13.0	1.12	1.17	1.17	0.92	0.99	1.17	1.17	0.92
13.5	1.03	1.09	1.09	0.82	0.88	1.07	1.09	0.82
14.0	0.95	1.01	1.01	0.74	0.79	0.98	1.01	0.74
14.5	0.88	0.94	0.94	0.66	0.70	0.90	0.94	0.66
15.0	0.81	0.88	0.88	0.60	0.62	0.83	0.88	0.60
15.5	0.75	0.82	0.82	0.54	0.55	0.76	0.82	0.54
16.0	0.70	0.77	0.77	0.49	0.49	0.70	0.77	0.49
16.5	0.65	0.73	0.73	0.45	0.44	0.65	0.72	0.45
17.0	0.60	0.69	0.69	0.41	0.40	0.59	0.67	0.41
17.5								
18.0								

MSS 250/23								
SPAN (m)	INWARDS				OUTWARDS			
	$\phi_b w_u$ kN/m			w_s kN/m	$\phi_b w_u$ kN/m			w_s kN/m
	1B	2B	3B		1B	2B	3B	
3.0								
3.5								
4.0	19.4	19.4	19.4	45.6	19.4	19.4	19.4	45.6
4.5	14.6	14.6	14.6	31.7	14.6	14.6	14.6	31.7
5.0	11.6	11.6	11.6	22.9	11.6	11.6	11.6	22.9
5.5	9.37	9.37	9.37	17.0	9.37	9.37	9.37	17.0
6.0	7.71	7.71	7.71	11.9	7.71	7.71	7.71	11.9
6.5	6.57	6.57	6.57	9.35	6.57	6.57	6.57	9.35
7.0	5.67	5.67	5.67	7.49	5.67	5.67	5.67	7.49
7.5	4.94	4.94	4.94	6.09	4.94	4.94	4.94	6.09
8.0	4.34	4.34	4.34	5.02	4.34	4.34	4.34	5.02
8.5	3.84	3.84	3.84	4.18	3.84	3.84	3.84	4.18
9.0	3.43	3.43	3.43	3.52	3.43	3.43	3.43	3.52
9.5	3.08	3.08	3.08	3.00	3.08	3.08	3.08	3.00
10.0	2.78	2.78	2.78	2.57	2.77	2.78	2.78	2.57
10.5	2.50	2.52	2.52	2.22	2.45	2.52	2.52	2.22
11.0	2.25	2.29	2.29	1.93	2.17	2.29	2.29	1.93
11.5	2.03	2.10	2.10	1.69	1.92	2.10	2.10	1.69
12.0	1.84	1.93	1.93	1.49	1.71	1.93	1.93	1.49
12.5	1.67	1.78	1.78	1.31	1.52	1.78	1.78	1.31
13.0	1.52	1.64	1.64	1.17	1.35	1.64	1.64	1.17
13.5	1.39	1.52	1.52	1.04	1.19	1.52	1.52	1.04
14.0	1.27	1.42	1.42	0.94	1.06	1.39	1.42	0.94
14.5	1.17	1.32	1.32	0.84	0.93	1.27	1.32	0.84
15.0	1.07	1.23	1.23	0.76	0.82	1.16	1.23	0.76
15.5	0.99	1.16	1.16	0.69	0.73	1.06	1.16	0.69
16.0	0.91	1.08	1.08	0.63	0.65	0.97	1.08	0.63
16.5	0.84	1.02	1.02	0.57	0.57	0.88	1.02	0.57
17.0	0.78	0.96	0.96	0.52	0.51	0.81	0.95	0.52
17.5								
18.0								

- 1B = One mid span brace
- 2B = Two equally spaced braces within the span
- 3B = Three equally spaced braces within the span
- w_s = Uniformly distributed serviceability load (kN/m) for deflection limit of Span/150
- $\phi_b w_u$ = Strength load resistance applied at the centroid (kN/m)

- 2-M12 Grade 4.6 bolts per connection
- 2-M12 Grade 8.8 bolts per connection
- 2-M16 Grade 4.6 bolts per connection
- 2-M16 Grade 8.8 bolts per connection

IMPORTANT

The adequacy of multispan system is very sensitive to actual applied loads. The stated loads in this table are assumed uniform over the full purlin system. Variations in actual project design loadings over the length of the purlin system must be checked specifically by the designer to verify system adequacy.

TWO SPAN LAPPED

LOAD TABLE – Uniformly Distributed Load

MSS 275/15								
SPAN (m)	INWARDS				OUTWARDS			
	$\phi_b w_u$ kN/m			W_s kN/m	$\phi_b w_u$ kN/m			W_s kN/m
	1B	2B	3B		1B	2B	3B	
3.0								
3.5								
4.0								
4.5	7.99	7.99	7.99	26.9	7.99	7.99	7.99	26.9
5.0	6.64	6.64	6.64	19.4	6.64	6.64	6.64	19.4
5.5	5.58	5.58	5.58	14.5	5.58	5.58	5.58	14.5
6.0	4.74	4.74	4.74	10.1	4.74	4.74	4.74	10.1
6.5	4.13	4.13	4.13	7.94	4.13	4.13	4.13	7.94
7.0	3.62	3.62	3.62	6.36	3.62	3.62	3.62	6.36
7.5	3.20	3.20	3.20	5.17	3.20	3.20	3.20	5.17
8.0	2.83	2.85	2.85	4.26	2.85	2.85	2.85	4.26
8.5	2.49	2.53	2.53	3.55	2.49	2.53	2.53	3.55
9.0	2.20	2.25	2.25	2.99	2.18	2.25	2.25	2.99
9.5	1.95	2.02	2.02	2.54	1.92	2.02	2.02	2.54
10.0	1.75	1.83	1.83	2.18	1.70	1.83	1.83	2.18
10.5	1.57	1.66	1.66	1.88	1.51	1.66	1.66	1.88
11.0	1.42	1.51	1.51	1.64	1.35	1.50	1.51	1.64
11.5	1.28	1.38	1.38	1.43	1.20	1.36	1.38	1.43
12.0	1.17	1.27	1.27	1.26	1.08	1.23	1.27	1.26
12.5	1.07	1.17	1.17	1.12	0.96	1.12	1.17	1.12
13.0	0.97	1.08	1.08	0.99	0.86	1.02	1.08	0.99
13.5	0.89	1.00	1.00	0.89	0.77	0.93	1.00	0.89
14.0	0.82	0.92	0.93	0.79	0.69	0.85	0.92	0.79
14.5	0.76	0.86	0.87	0.72	0.62	0.78	0.85	0.72
15.0	0.70	0.79	0.81	0.65	0.56	0.72	0.79	0.65
15.5	0.65	0.74	0.76	0.59	0.50	0.66	0.73	0.59
16.0	0.60	0.69	0.71	0.53	0.45	0.61	0.68	0.53
16.5	0.56	0.64	0.67	0.49	0.41	0.56	0.63	0.49
17.0	0.52	0.60	0.63	0.44	0.37	0.51	0.58	0.44
17.5								
18.0								

MSS 275/18								
SPAN (m)	INWARDS				OUTWARDS			
	$\phi_b w_u$ kN/m			W_s kN/m	$\phi_b w_u$ kN/m			W_s kN/m
	1B	2B	3B		1B	2B	3B	
3.0								
3.5								
4.0								
4.5	11.0	11.0	11.0	32.3	11.0	11.0	11.0	32.3
5.0	9.02	9.02	9.02	23.3	9.02	9.02	9.02	23.3
5.5	7.50	7.50	7.50	17.34	7.50	7.50	7.50	17.34
6.0	6.17	6.17	6.17	12.11	6.17	6.17	6.17	12.11
6.5	5.26	5.26	5.26	9.52	5.26	5.26	5.26	9.52
7.0	4.53	4.53	4.53	7.62	4.53	4.53	4.53	7.62
7.5	3.95	3.95	3.95	6.20	3.95	3.95	3.95	6.20
8.0	3.47	3.47	3.47	5.11	3.47	3.47	3.47	5.11
8.5	3.07	3.07	3.07	4.26	3.07	3.07	3.07	4.26
9.0	2.74	2.74	2.74	3.59	2.74	2.74	2.74	3.59
9.5	2.46	2.46	2.46	3.05	2.46	2.46	2.46	3.05
10.0	2.22	2.22	2.22	2.61	2.20	2.22	2.22	2.61
10.5	2.00	2.01	2.01	2.26	1.96	2.01	2.01	2.26
11.0	1.81	1.84	1.84	1.96	1.76	1.84	1.84	1.96
11.5	1.64	1.68	1.68	1.72	1.57	1.68	1.68	1.72
12.0	1.49	1.54	1.54	1.51	1.41	1.54	1.54	1.51
12.5	1.36	1.42	1.42	1.34	1.27	1.42	1.42	1.34
13.0	1.25	1.31	1.31	1.19	1.15	1.31	1.31	1.19
13.5	1.15	1.22	1.22	1.06	1.04	1.21	1.22	1.06
14.0	1.06	1.13	1.13	0.95	0.94	1.11	1.13	0.95
14.5	0.97	1.06	1.06	0.86	0.85	1.02	1.06	0.86
15.0	0.90	0.99	0.99	0.77	0.76	0.94	0.99	0.77
15.5	0.84	0.92	0.92	0.70	0.68	0.86	0.92	0.70
16.0	0.78	0.87	0.87	0.64	0.60	0.80	0.87	0.64
16.5	0.72	0.82	0.82	0.58	0.54	0.74	0.81	0.58
17.0	0.67	0.77	0.77	0.53	0.48	0.68	0.76	0.53
17.5								
18.0								

- 1B = One mid span brace
- 2B = Two equally spaced braces within the span
- 3B = Three equally spaced braces within the span
- w_s = Uniformly distributed serviceability load (kN/m) for deflection limit of Span/150
- $\phi_b w_u$ = Strength load resistance applied at the centroid (kN/m)

- 2-M12 Grade 4.6 bolts per connection
- 2-M12 Grade 8.8 bolts per connection
- 2-M16 Grade 4.6 bolts per connection
- 2-M16 Grade 8.8 bolts per connection

IMPORTANT

The adequacy of multispan system is very sensitive to actual applied loads. The stated loads in this table are assumed uniform over the full purlin system. Variations in actual project design loadings over the length of the purlin system must be checked specifically by the designer to verify system adequacy.

TWO SPAN LAPPED

LOAD TABLE – Uniformly Distributed Load

MSS 300/15								
SPAN (m)	INWARDS				OUTWARDS			
	$\phi_b w_u$ kN/m			W_s kN/m	$\phi_b w_u$ kN/m			W_s kN/m
	1B	2B	3B		1B	2B	3B	
3.0								
3.5								
4.0								
4.5								
5.0	6.80	6.80	6.80	25.55	6.80	6.80	6.80	25.55
5.5	5.79	5.79	5.79	19.03	5.79	5.79	5.79	19.03
6.0	4.96	4.96	4.96	13.3	4.96	4.96	4.96	13.3
6.5	4.36	4.36	4.36	10.4	4.36	4.36	4.36	10.4
7.0	3.85	3.85	3.85	8.36	3.85	3.85	3.85	8.36
7.5	3.43	3.43	3.43	6.80	3.43	3.43	3.43	6.80
8.0	3.07	3.07	3.07	5.60	3.07	3.07	3.07	5.60
8.5	2.76	2.76	2.76	4.67	2.76	2.76	2.76	4.67
9.0	2.49	2.49	2.49	3.94	2.49	2.49	2.49	3.94
9.5	2.26	2.26	2.26	3.35	2.26	2.26	2.26	3.35
10.0	2.04	2.06	2.06	2.87	2.04	2.06	2.06	2.87
10.5	1.83	1.89	1.89	2.48	1.82	1.89	1.89	2.48
11.0	1.65	1.73	1.73	2.16	1.63	1.73	1.73	2.16
11.5	1.50	1.60	1.60	1.89	1.46	1.60	1.60	1.89
12.0	1.36	1.47	1.47	1.66	1.31	1.46	1.47	1.66
12.5	1.24	1.35	1.35	1.47	1.19	1.33	1.35	1.47
13.0	1.14	1.25	1.25	1.31	1.07	1.22	1.25	1.31
13.5	1.05	1.16	1.16	1.17	0.97	1.12	1.16	1.17
14.0	0.96	1.08	1.08	1.05	0.88	1.03	1.08	1.05
14.5	0.89	1.00	1.00	0.94	0.79	0.94	1.00	0.94
15.0	0.82	0.93	0.94	0.85	0.72	0.87	0.93	0.85
15.5	0.76	0.87	0.88	0.77	0.65	0.80	0.87	0.77
16.0	0.71	0.81	0.82	0.70	0.59	0.74	0.81	0.70
16.5	0.66	0.76	0.77	0.64	0.54	0.69	0.75	0.64
17.0	0.61	0.71	0.73	0.58	0.49	0.64	0.70	0.58
17.5	0.57	0.66	0.69	0.54	0.44	0.59	0.66	0.54
18.0	0.54	0.62	0.65	0.49	0.40	0.55	0.61	0.49

MSS 300/18								
SPAN (m)	INWARDS				OUTWARDS			
	$\phi_b w_u$ kN/m			W_s kN/m	$\phi_b w_u$ kN/m			W_s kN/m
	1B	2B	3B		1B	2B	3B	
3.0								
3.5								
4.0								
4.5								
5.0	9.53	9.53	9.53	30.64	9.53	9.53	9.53	30.64
5.5	8.03	8.03	8.03	22.82	8.03	8.03	8.03	22.82
6.0	6.82	6.82	6.82	15.93	6.82	6.82	6.82	15.93
6.5	5.95	5.94	5.94	12.53	5.95	5.94	5.94	12.53
7.0	5.22	5.22	5.22	10.03	5.22	5.22	5.22	10.03
7.5	4.57	4.57	4.57	8.16	4.57	4.57	4.57	8.16
8.0	4.02	4.02	4.02	6.72	4.02	4.02	4.02	6.72
8.5	3.56	3.56	3.56	5.60	3.56	3.56	3.56	5.60
9.0	3.18	3.18	3.18	4.72	3.18	3.18	3.18	4.72
9.5	2.85	2.85	2.85	4.01	2.85	2.85	2.85	4.01
10.0	2.57	2.57	2.57	3.44	2.57	2.57	2.57	3.44
10.5	2.32	2.33	2.33	2.97	2.33	2.33	2.33	2.97
11.0	2.10	2.13	2.13	2.58	2.10	2.13	2.13	2.58
11.5	1.90	1.95	1.95	2.26	1.89	1.95	1.95	2.26
12.0	1.73	1.79	1.79	1.99	1.70	1.79	1.79	1.99
12.5	1.58	1.65	1.65	1.76	1.54	1.65	1.65	1.76
13.0	1.45	1.52	1.52	1.57	1.40	1.52	1.52	1.57
13.5	1.33	1.41	1.41	1.40	1.27	1.41	1.41	1.40
14.0	1.23	1.31	1.31	1.25	1.15	1.31	1.31	1.25
14.5	1.13	1.22	1.22	1.13	1.05	1.22	1.22	1.13
15.0	1.05	1.14	1.14	1.02	0.95	1.12	1.14	1.02
15.5	0.97	1.07	1.07	0.92	0.87	1.04	1.07	0.92
16.0	0.91	1.01	1.01	0.84	0.79	0.96	1.01	0.84
16.5	0.84	0.95	0.95	0.77	0.72	0.89	0.95	0.77
17.0	0.79	0.89	0.89	0.70	0.66	0.83	0.89	0.70
17.5	0.73	0.84	0.84	0.64	0.60	0.77	0.84	0.64
18.0	0.69	0.79	0.79	0.59	0.55	0.72	0.79	0.59

- 1B = One mid span brace
- 2B = Two equally spaced braces within the span
- 3B = Three equally spaced braces within the span
- w_s = Uniformly distributed serviceability load (kN/m) for deflection limit of Span/150
- $\phi_b w_u$ = Strength load resistance applied at the centroid (kN/m)

- 2-M12 Grade 4.6 bolts per connection
- 2-M12 Grade 8.8 bolts per connection
- 2-M16 Grade 4.6 bolts per connection
- 2-M16 Grade 8.8 bolts per connection

IMPORTANT

The adequacy of multispan system is very sensitive to actual applied loads. The stated loads in this table are assumed uniform over the full purlin system. Variations in actual project design loadings over the length of the purlin system must be checked specifically by the designer to verify system adequacy.

TWO SPAN LAPPED

LOAD TABLE – Uniformly Distributed Load

MSS 300/23

SPAN (m)	INWARDS				OUTWARDS			
	$\phi_b w_u$ kN/m			W_s kN/m	$\phi_b w_u$ kN/m			W_s kN/m
	1B	2B	3B		1B	2B	3B	
3.0								
3.5								
4.0								
4.5								
5.0	15.2	15.2	15.2	38.98	15.2	15.2	15.2	38.98
5.5	12.3	12.3	12.3	29.03	12.3	12.3	12.3	29.03
6.0	10.1	10.1	10.1	20.26	10.1	10.1	10.1	20.26
6.5	8.59	8.59	8.59	15.94	8.59	8.59	8.59	15.94
7.0	7.41	7.41	7.41	12.76	7.41	7.41	7.41	12.76
7.5	6.45	6.45	6.45	10.38	6.45	6.45	6.45	10.38
8.0	5.67	5.67	5.67	8.55	5.67	5.67	5.67	8.55
8.5	5.02	5.02	5.02	7.13	5.02	5.02	5.02	7.13
9.0	4.48	4.48	4.48	6.00	4.48	4.48	4.48	6.00
9.5	4.02	4.02	4.02	5.11	4.02	4.02	4.02	5.11
10.0	3.63	3.63	3.63	4.38	3.63	3.63	3.63	4.38
10.5	3.29	3.29	3.29	3.78	3.29	3.29	3.29	3.78
11.0	3.00	3.00	3.00	3.29	3.00	3.00	3.00	3.29
11.5	2.75	2.75	2.75	2.88	2.75	2.75	2.75	2.88
12.0	2.52	2.52	2.52	2.53	2.52	2.52	2.52	2.53
12.5	2.31	2.32	2.32	2.24	2.30	2.32	2.32	2.24
13.0	2.11	2.15	2.15	1.99	2.07	2.15	2.15	1.99
13.5	1.93	1.99	1.99	1.78	1.87	1.99	1.99	1.78
14.0	1.77	1.85	1.85	1.60	1.68	1.85	1.85	1.60
14.5	1.62	1.73	1.73	1.44	1.52	1.73	1.73	1.44
15.0	1.50	1.61	1.61	1.30	1.37	1.61	1.61	1.30
15.5	1.38	1.51	1.51	1.18	1.24	1.51	1.51	1.18
16.0	1.28	1.42	1.42	1.07	1.12	1.42	1.42	1.07
16.5	1.18	1.33	1.33	0.97	1.01	1.33	1.33	0.97
17.0	1.10	1.26	1.26	0.89	0.91	1.26	1.26	0.89
17.5	1.02	1.19	1.19	0.82	0.82	1.19	1.19	0.82
18.0	0.95	1.12	1.12	0.75	0.74	1.12	1.12	0.75

MSS 300/24

SPAN (m)	INWARDS				OUTWARDS			
	$\phi_b w_u$ kN/m			W_s kN/m	$\phi_b w_u$ kN/m			W_s kN/m
	1B	2B	3B		1B	2B	3B	
3.0								
3.5								
4.0								
4.5								
5.0	16.6	16.6	16.6	41.48	16.6	16.6	16.6	41.48
5.5	13.4	13.4	13.4	30.89	13.4	13.4	13.4	30.89
6.0	11.0	11.0	11.0	21.57	11.0	11.0	11.0	21.57
6.5	9.40	9.40	9.40	16.96	9.40	9.40	9.40	16.96
7.0	8.11	8.11	8.11	13.58	8.11	8.11	8.11	13.58
7.5	7.06	7.06	7.06	11.04	7.06	7.06	7.06	11.04
8.0	6.21	6.21	6.21	9.10	6.21	6.21	6.21	9.10
8.5	5.50	5.50	5.50	7.58	5.50	5.50	5.50	7.58
9.0	4.90	4.90	4.90	6.39	4.90	4.90	4.90	6.39
9.5	4.40	4.40	4.40	5.43	4.40	4.40	4.40	5.43
10.0	3.97	3.97	3.97	4.66	3.97	3.97	3.97	4.66
10.5	3.60	3.60	3.60	4.02	3.60	3.60	3.60	4.02
11.0	3.28	3.28	3.28	3.50	3.28	3.28	3.28	3.50
11.5	3.00	3.00	3.00	3.06	3.00	3.00	3.00	3.06
12.0	2.72	2.76	2.76	2.70	2.76	2.76	2.76	2.70
12.5	2.47	2.54	2.54	2.38	2.48	2.54	2.54	2.38
13.0	2.25	2.35	2.35	2.12	2.23	2.35	2.35	2.12
13.5	2.06	2.18	2.18	1.89	2.02	2.18	2.18	1.89
14.0	1.89	2.03	2.03	1.70	1.82	2.03	2.03	1.70
14.5	1.74	1.89	1.89	1.53	1.64	1.89	1.89	1.53
15.0	1.60	1.77	1.77	1.38	1.48	1.77	1.77	1.38
15.5	1.48	1.65	1.65	1.25	1.34	1.65	1.65	1.25
16.0	1.36	1.55	1.55	1.14	1.21	1.55	1.55	1.14
16.5	1.26	1.46	1.46	1.04	1.09	1.46	1.46	1.04
17.0	1.17	1.37	1.37	0.95	0.98	1.37	1.37	0.95
17.5	1.09	1.30	1.30	0.87	0.88	1.30	1.30	0.87
18.0	1.01	1.23	1.23	0.80	0.79	1.23	1.23	0.80

- 1B = One mid span brace
- 2B = Two equally spaced braces within the span
- 3B = Three equally spaced braces within the span
- w_s = Uniformly distributed serviceability load (kN/m) for deflection limit of Span/150
- $\phi_b w_u$ = Strength load resistance applied at the centroid (kN/m)

- 2-M12 Grade 4.6 bolts per connection
- 2-M12 Grade 8.8 bolts per connection
- 2-M16 Grade 4.6 bolts per connection
- 2-M16 Grade 8.8 bolts per connection

IMPORTANT

The adequacy of multispan system is very sensitive to actual applied loads. The stated loads in this table are assumed uniform over the full purlin system. Variations in actual project design loadings over the length of the purlin system must be checked specifically by the designer to verify system adequacy.

TWO SPAN LAPPED

LOAD TABLE – Uniformly Distributed Load

MSS 300/30								
SPAN (m)	INWARDS				OUTWARDS			
	$\phi_b w_u$ kN/m			w_s kN/m	$\phi_b w_u$ kN/m			w_s kN/m
	1B	2B	3B		1B	2B	3B	
3.0								
3.5								
4.0								
4.5								
5.0	18.7	18.7	18.7	50.4	18.7	18.7	18.7	50.4
5.5	17.0	17.0	17.0	37.5	17.0	17.0	17.0	37.5
6.0	14.5	14.5	14.5	26.2	14.5	14.5	14.5	26.2
6.5	12.4	12.4	12.4	20.6	12.4	12.4	12.4	20.6
7.0	10.7	10.7	10.7	16.5	10.7	10.7	10.7	16.5
7.5	9.28	9.28	9.28	13.4	9.28	9.28	9.28	13.4
8.0	8.16	8.16	8.16	11.1	8.16	8.16	8.16	11.1
8.5	7.23	7.23	7.23	9.22	7.23	7.23	7.23	9.22
9.0	6.44	6.44	6.44	7.77	6.44	6.44	6.44	7.77
9.5	5.78	5.78	5.78	6.60	5.78	5.78	5.78	6.60
10.0	5.22	5.22	5.22	5.66	5.22	5.22	5.22	5.66
10.5	4.65	4.74	4.74	4.89	4.74	4.74	4.74	4.89
11.0	4.16	4.31	4.31	4.25	4.31	4.31	4.31	4.25
11.5	3.74	3.95	3.95	3.72	3.95	3.95	3.95	3.72
12.0	3.37	3.63	3.63	3.28	3.51	3.63	3.63	3.28
12.5	3.05	3.34	3.34	2.90	3.15	3.34	3.34	2.90
13.0	2.77	3.09	3.09	2.58	2.83	3.09	3.09	2.58
13.5	2.52	2.86	2.86	2.30	2.54	2.86	2.86	2.30
14.0	2.30	2.66	2.66	2.06	2.28	2.66	2.66	2.06
14.5	2.11	2.48	2.48	1.86	2.06	2.48	2.48	1.86
15.0	1.93	2.32	2.32	1.68	1.85	2.32	2.32	1.68
15.5	1.78	2.17	2.17	1.52	1.67	2.17	2.17	1.52
16.0	1.64	2.04	2.04	1.38	1.50	2.04	2.04	1.38
16.5	1.51	1.92	1.92	1.26	1.35	1.84	1.92	1.26
17.0	1.40	1.81	1.81	1.15	1.21	1.70	1.81	1.15
17.5	1.29	1.70	1.70	1.06	1.09	1.56	1.70	1.06
18.0	1.20	1.61	1.61	0.97	0.98	1.44	1.61	0.97

MSS 325/15								
SPAN (m)	INWARDS				OUTWARDS			
	$\phi_b w_u$ kN/m			w_s kN/m	$\phi_b w_u$ kN/m			w_s kN/m
	1B	2B	3B		1B	2B	3B	
3.0								
3.5								
4.0								
4.5								
5.0	6.99	6.99	6.99	30.84	6.99	6.99	6.99	30.84
5.5	5.99	5.99	5.99	22.97	5.99	5.99	5.99	22.97
6.0	5.17	5.17	5.16	16.03	5.17	5.17	5.16	16.03
6.5	4.55	4.55	4.55	12.61	4.55	4.55	4.55	12.61
7.0	4.04	4.04	4.04	10.10	4.04	4.04	4.04	10.10
7.5	3.61	3.61	3.61	8.21	3.61	3.61	3.61	8.21
8.0	3.24	3.24	3.24	6.76	3.24	3.24	3.24	6.76
8.5	2.92	2.92	2.92	5.64	2.92	2.92	2.92	5.64
9.0	2.64	2.64	2.64	4.75	2.64	2.64	2.64	4.75
9.5	2.41	2.41	2.41	4.04	2.41	2.41	2.41	4.04
10.0	2.20	2.20	2.20	3.46	2.20	2.20	2.20	3.46
10.5	1.99	2.01	2.01	2.99	1.98	2.01	2.01	2.99
11.0	1.79	1.85	1.85	2.60	1.77	1.85	1.85	2.60
11.5	1.63	1.71	1.71	2.28	1.59	1.71	1.71	2.28
12.0	1.48	1.58	1.58	2.00	1.43	1.58	1.58	2.00
12.5	1.35	1.47	1.47	1.77	1.29	1.45	1.47	1.77
13.0	1.24	1.36	1.36	1.58	1.16	1.33	1.36	1.58
13.5	1.14	1.26	1.26	1.41	1.05	1.22	1.26	1.41
14.0	1.05	1.17	1.17	1.26	0.95	1.12	1.17	1.26
14.5	0.96	1.09	1.09	1.14	0.86	1.03	1.09	1.14
15.0	0.89	1.01	1.02	1.03	0.78	0.95	1.02	1.03
15.5	0.83	0.94	0.95	0.93	0.71	0.87	0.94	0.93
16.0	0.77	0.88	0.89	0.85	0.64	0.81	0.88	0.85
16.5	0.71	0.82	0.84	0.77	0.58	0.75	0.82	0.77
17.0	0.66	0.77	0.79	0.70	0.52	0.69	0.76	0.70
17.5	0.62	0.72	0.75	0.65	0.47	0.64	0.71	0.65
18.0	0.58	0.67	0.71	0.59	0.43	0.59	0.67	0.59

- 1B = One mid span brace
- 2B = Two equally spaced braces within the span
- 3B = Three equally spaced braces within the span
- w_s = Uniformly distributed serviceability load (kN/m) for deflection limit of Span/150
- $\phi_b w_u$ = Strength load resistance applied at the centroid (kN/m)

- 2-M12 Grade 4.6 bolts per connection
- 2-M12 Grade 8.8 bolts per connection
- 2-M16 Grade 4.6 bolts per connection
- 2-M16 Grade 8.8 bolts per connection

IMPORTANT

The adequacy of multispan system is very sensitive to actual applied loads. The stated loads in this table are assumed uniform over the full purlin system. Variations in actual project design loadings over the length of the purlin system must be checked specifically by the designer to verify system adequacy.

TWO SPAN LAPPED

LOAD TABLE – Uniformly Distributed Load

MSS 325/18								
SPAN (m)	INWARDS				OUTWARDS			
	$\phi_b w_u$ kN/m			W_s kN/m	$\phi_b w_u$ kN/m			W_s kN/m
	1B	2B	3B		1B	2B	3B	
3.0								
3.5								
4.0								
4.5								
5.0	9.90	9.90	9.89	37.00	9.90	9.90	9.89	37.00
5.5	8.38	8.38	8.38	27.56	8.38	8.38	8.38	27.56
6.0	7.16	7.16	7.16	19.24	7.16	7.16	7.16	19.24
6.5	6.26	6.26	6.26	15.13	6.26	6.26	6.26	15.13
7.0	5.52	5.52	5.52	12.11	5.52	5.52	5.52	12.11
7.5	4.90	4.90	4.90	9.85	4.90	4.90	4.90	9.85
8.0	4.37	4.37	4.37	8.12	4.37	4.37	4.37	8.12
8.5	3.87	3.87	3.87	6.77	3.87	3.87	3.87	6.77
9.0	3.45	3.45	3.45	5.70	3.45	3.45	3.45	5.70
9.5	3.10	3.10	3.10	4.85	3.10	3.10	3.10	4.85
10.0	2.80	2.80	2.80	4.16	2.80	2.80	2.80	4.16
10.5	2.52	2.54	2.54	3.59	2.54	2.54	2.54	3.59
11.0	2.27	2.31	2.31	3.12	2.27	2.31	2.31	3.12
11.5	2.06	2.11	2.11	2.73	2.05	2.11	2.11	2.73
12.0	1.87	1.94	1.94	2.40	1.85	1.94	1.94	2.40
12.5	1.71	1.79	1.79	2.13	1.67	1.79	1.79	2.13
13.0	1.57	1.65	1.65	1.89	1.51	1.65	1.65	1.89
13.5	1.44	1.53	1.53	1.69	1.37	1.53	1.53	1.69
14.0	1.33	1.43	1.43	1.51	1.25	1.43	1.43	1.51
14.5	1.23	1.33	1.33	1.36	1.13	1.32	1.33	1.36
15.0	1.13	1.24	1.24	1.23	1.03	1.22	1.24	1.23
15.5	1.05	1.16	1.16	1.12	0.94	1.13	1.16	1.12
16.0	0.98	1.09	1.09	1.01	0.85	1.04	1.09	1.01
16.5	0.91	1.03	1.03	0.93	0.78	0.97	1.03	0.93
17.0	0.85	0.97	0.97	0.85	0.71	0.90	0.97	0.85
17.5	0.79	0.91	0.91	0.78	0.64	0.83	0.91	0.78
18.0	0.74	0.86	0.86	0.71	0.59	0.78	0.86	0.71

MSS 350/18								
SPAN (m)	INWARDS				OUTWARDS			
	$\phi_b w_u$ kN/m			W_s kN/m	$\phi_b w_u$ kN/m			W_s kN/m
	1B	2B	3B		1B	2B	3B	
3.0								
3.5								
4.0								
4.5								
5.0								
5.5								
6.0	7.00	7.00	7.00	23.29	7.00	7.00	7.00	23.29
6.5	6.18	6.18	6.18	18.32	6.18	6.18	6.18	18.32
7.0	5.49	5.49	5.49	14.67	5.49	5.49	5.49	14.67
7.5	4.91	4.91	4.91	11.92	4.91	4.91	4.91	11.92
8.0	4.42	4.42	4.42	9.82	4.42	4.42	4.42	9.82
8.5	3.99	3.99	3.99	8.19	3.99	3.99	3.99	8.19
9.0	3.62	3.62	3.62	6.90	3.62	3.62	3.62	6.90
9.5	3.29	3.30	3.30	5.87	3.29	3.30	3.30	5.87
10.0	3.01	3.01	3.01	5.03	3.01	3.01	3.01	5.03
10.5	2.76	2.76	2.76	4.35	2.76	2.76	2.76	4.35
11.0	2.53	2.54	2.54	3.78	2.54	2.54	2.54	3.78
11.5	2.29	2.35	2.35	3.31	2.29	2.35	2.35	3.31
12.0	2.08	2.17	2.17	2.91	2.06	2.17	2.17	2.91
12.5	1.90	2.00	2.00	2.58	1.87	2.00	2.00	2.58
13.0	1.74	1.85	1.85	2.29	1.69	1.85	1.85	2.29
13.5	1.60	1.72	1.72	2.04	1.53	1.72	1.72	2.04
14.0	1.47	1.59	1.59	1.83	1.39	1.59	1.59	1.83
14.5	1.35	1.49	1.49	1.65	1.27	1.47	1.49	1.65
15.0	1.25	1.39	1.39	1.49	1.15	1.36	1.39	1.49
15.5	1.16	1.30	1.30	1.35	1.05	1.26	1.30	1.35
16.0	1.08	1.22	1.22	1.23	0.96	1.17	1.22	1.23
16.5	1.00	1.15	1.15	1.12	0.87	1.08	1.15	1.12
17.0	0.93	1.08	1.08	1.02	0.79	1.00	1.08	1.02
17.5	0.87	1.02	1.02	0.94	0.72	0.93	1.02	0.94
18.0	0.81	0.96	0.96	0.86	0.66	0.87	0.95	0.86

- 1B = One mid span brace
- 2B = Two equally spaced braces within the span
- 3B = Three equally spaced braces within the span
- w_s = Uniformly distributed serviceability load (kN/m) for deflection limit of Span/150
- $\phi_b w_u$ = Strength load resistance applied at the centroid (kN/m)

- 2-M12 Grade 4.6 bolts per connection
- 2-M12 Grade 8.8 bolts per connection
- 2-M16 Grade 4.6 bolts per connection
- 2-M16 Grade 8.8 bolts per connection

IMPORTANT

The adequacy of multispan system is very sensitive to actual applied loads. The stated loads in this table are assumed uniform over the full purlin system. Variations in actual project design loadings over the length of the purlin system must be checked specifically by the designer to verify system adequacy.

TWO SPAN LAPPED

LOAD TABLE – Uniformly Distributed Load

MSS 350/23								
SPAN (m)	INWARDS				OUTWARDS			
	$\phi_b w_u$ kN/m			w_s kN/m	$\phi_b w_u$ kN/m			w_s kN/m
	1B	2B	3B		1B	2B	3B	
3.0								
3.5								
4.0								
4.5								
5.0								
5.5								
6.0	11.6	11.6	11.6	29.67	11.6	11.6	11.6	29.67
6.5	10.2	10.2	10.2	23.33	10.2	10.2	10.2	23.33
7.0	8.97	8.97	8.97	18.68	8.97	8.97	8.97	18.68
7.5	7.85	7.85	7.85	15.19	7.85	7.85	7.85	15.19
8.0	6.90	6.90	6.90	12.52	6.90	6.90	6.90	12.52
8.5	6.11	6.11	6.11	10.43	6.11	6.11	6.11	10.43
9.0	5.45	5.45	5.45	8.79	5.45	5.45	5.45	8.79
9.5	4.89	4.89	4.89	7.47	4.89	4.89	4.89	7.47
10.0	4.42	4.42	4.42	6.41	4.42	4.42	4.42	6.41
10.5	4.01	4.01	4.01	5.54	4.01	4.01	4.01	5.54
11.0	3.65	3.65	3.65	4.81	3.65	3.65	3.65	4.81
11.5	3.33	3.34	3.34	4.21	3.34	3.34	3.34	4.21
12.0	3.02	3.07	3.07	3.71	3.07	3.07	3.07	3.71
12.5	2.76	2.83	2.83	3.28	2.78	2.83	2.83	3.28
13.0	2.52	2.61	2.61	2.92	2.52	2.61	2.61	2.92
13.5	2.31	2.42	2.42	2.60	2.28	2.42	2.42	2.60
14.0	2.12	2.25	2.25	2.34	2.08	2.25	2.25	2.34
14.5	1.96	2.10	2.10	2.10	1.89	2.10	2.10	2.10
15.0	1.81	1.96	1.96	1.90	1.72	1.96	1.96	1.90
15.5	1.67	1.84	1.84	1.72	1.57	1.84	1.84	1.72
16.0	1.55	1.73	1.73	1.56	1.43	1.73	1.73	1.56
16.5	1.44	1.62	1.62	1.43	1.29	1.61	1.62	1.43
17.0	1.34	1.53	1.53	1.30	1.16	1.50	1.53	1.30
17.5	1.25	1.44	1.44	1.20	1.05	1.39	1.44	1.20
18.0	1.17	1.36	1.36	1.10	0.94	1.29	1.36	1.10

MSS 350/24								
SPAN (m)	INWARDS				OUTWARDS			
	$\phi_b w_u$ kN/m			w_s kN/m	$\phi_b w_u$ kN/m			w_s kN/m
	1B	2B	3B		1B	2B	3B	
3.0								
3.5								
4.0								
4.5								
5.0								
5.5								
6.0	13.1	13.1	13.1	31.55	13.1	13.1	13.1	31.55
6.5	11.4	11.4	11.4	24.81	11.4	11.4	11.4	24.81
7.0	9.84	9.84	9.84	19.87	9.84	9.84	9.84	19.87
7.5	8.57	8.57	8.57	16.15	8.57	8.57	8.57	16.15
8.0	7.54	7.54	7.54	13.31	7.54	7.54	7.54	13.31
8.5	6.68	6.68	6.68	11.10	6.68	6.68	6.68	11.10
9.0	5.95	5.95	5.95	9.35	5.95	5.95	5.95	9.35
9.5	5.34	5.34	5.34	7.95	5.34	5.34	5.34	7.95
10.0	4.82	4.82	4.82	6.81	4.82	4.82	4.82	6.81
10.5	4.37	4.37	4.37	5.89	4.37	4.37	4.37	5.89
11.0	3.99	3.99	3.99	5.12	3.99	3.99	3.99	5.12
11.5	3.65	3.65	3.65	4.48	3.65	3.65	3.65	4.48
12.0	3.34	3.35	3.35	3.94	3.35	3.35	3.35	3.94
12.5	3.04	3.09	3.09	3.49	3.08	3.09	3.09	3.49
13.0	2.78	2.85	2.85	3.10	2.79	2.85	2.85	3.10
13.5	2.55	2.65	2.65	2.77	2.54	2.65	2.65	2.77
14.0	2.34	2.46	2.46	2.48	2.31	2.46	2.46	2.48
14.5	2.16	2.29	2.29	2.24	2.09	2.29	2.29	2.24
15.0	1.98	2.14	2.14	2.02	1.89	2.14	2.14	2.02
15.5	1.83	2.01	2.01	1.83	1.70	2.01	2.01	1.83
16.0	1.69	1.88	1.88	1.66	1.54	1.88	1.88	1.66
16.5	1.56	1.77	1.77	1.52	1.39	1.77	1.77	1.52
17.0	1.45	1.67	1.67	1.39	1.25	1.66	1.67	1.39
17.5	1.34	1.58	1.58	1.27	1.13	1.55	1.58	1.27
18.0	1.25	1.49	1.49	1.17	1.01	1.44	1.49	1.17

- 1B = One mid span brace
- 2B = Two equally spaced braces within the span
- 3B = Three equally spaced braces within the span
- w_s = Uniformly distributed serviceability load (kN/m) for deflection limit of Span/150
- $\phi_b w_u$ = Strength load resistance applied at the centroid (kN/m)

- 2-M12 Grade 4.6 bolts per connection
- 2-M12 Grade 8.8 bolts per connection
- 2-M16 Grade 4.6 bolts per connection
- 2-M16 Grade 8.8 bolts per connection

IMPORTANT

The adequacy of multispan system is very sensitive to actual applied loads. The stated loads in this table are assumed uniform over the full purlin system. Variations in actual project design loadings over the length of the purlin system must be checked specifically by the designer to verify system adequacy.

TWO SPAN LAPPED

LOAD TABLE – Uniformly Distributed Load

MSS 350/30								
SPAN (m)	INWARDS				OUTWARDS			
	$\phi_b w_u$ kN/m			W_s kN/m	$\phi_b w_u$ kN/m			W_s kN/m
	1B	2B	3B		1B	2B	3B	
3.0								
3.5								
4.0								
4.5								
5.0								
5.5								
6.0	15.6	15.6	15.6	38.41	15.6	15.6	15.6	38.41
6.5	14.4	14.4	14.4	30.21	14.4	14.4	14.4	30.21
7.0	13.0	13.0	13.0	24.19	13.0	13.0	13.0	24.19
7.5	11.3	11.3	11.3	19.66	11.3	11.3	11.3	19.66
8.0	9.95	9.95	9.95	16.20	9.95	9.95	9.95	16.20
8.5	8.81	8.81	8.81	13.51	8.81	8.81	8.81	13.51
9.0	7.86	7.86	7.86	11.38	7.86	7.86	7.86	11.38
9.5	7.05	7.05	7.05	9.68	7.05	7.05	7.05	9.68
10.0	6.37	6.37	6.37	8.30	6.37	6.37	6.37	8.30
10.5	5.77	5.77	5.77	7.17	5.77	5.77	5.77	7.17
11.0	5.19	5.26	5.26	6.23	5.26	5.26	5.26	6.23
11.5	4.65	4.81	4.81	5.45	4.81	4.81	4.81	5.45
12.0	4.19	4.42	4.42	4.80	4.42	4.42	4.42	4.80
12.5	3.79	4.07	4.07	4.25	3.98	4.07	4.07	4.25
13.0	3.43	3.77	3.77	3.78	3.57	3.77	3.77	3.78
13.5	3.12	3.49	3.49	3.37	3.21	3.49	3.49	3.37
14.0	2.84	3.25	3.25	3.02	2.89	3.25	3.25	3.02
14.5	2.60	3.03	3.03	2.72	2.60	3.03	3.03	2.72
15.0	2.38	2.83	2.83	2.46	2.34	2.83	2.83	2.46
15.5	2.19	2.65	2.65	2.23	2.11	2.65	2.65	2.23
16.0	2.01	2.49	2.49	2.03	1.90	2.49	2.49	2.03
16.5	1.85	2.34	2.34	1.85	1.71	2.33	2.34	1.85
17.0	1.71	2.20	2.20	1.69	1.53	2.15	2.20	1.69
17.5	1.58	2.08	2.08	1.55	1.38	1.98	2.08	1.55
18.0	1.46	1.97	1.97	1.42	1.24	1.83	1.97	1.42

MSS 400/20								
SPAN (m)	INWARDS				OUTWARDS			
	$\phi_b w_u$ kN/m			W_s kN/m	$\phi_b w_u$ kN/m			W_s kN/m
	1B	2B	3B		1B	2B	3B	
3.0								
3.5								
4.0								
4.5								
5.0								
5.5								
6.0	8.13	8.13	8.13	36.03	8.13	8.13	8.13	36.03
6.5	7.27	7.27	7.27	28.34	7.27	7.27	7.27	28.34
7.0	6.53	6.53	6.53	22.69	6.53	6.53	6.53	22.69
7.5	5.90	5.90	5.90	18.45	5.90	5.90	5.90	18.45
8.0	5.35	5.35	5.35	15.20	5.35	5.35	5.35	15.20
8.5	4.88	4.88	4.88	12.67	4.88	4.88	4.88	12.67
9.0	4.46	4.46	4.46	10.68	4.46	4.46	4.46	10.68
9.5	4.09	4.09	4.09	9.08	4.09	4.09	4.09	9.08
10.0	3.77	3.77	3.77	7.78	3.77	3.77	3.77	7.78
10.5	3.48	3.48	3.47	6.72	3.48	3.48	3.47	6.72
11.0	3.22	3.22	3.22	5.85	3.22	3.22	3.22	5.85
11.5	2.98	2.99	2.99	5.12	2.98	2.99	2.99	5.12
12.0	2.78	2.78	2.78	4.50	2.78	2.78	2.78	4.50
12.5	2.55	2.59	2.59	3.98	2.55	2.59	2.59	3.98
13.0	2.34	2.42	2.42	3.54	2.32	2.42	2.42	3.54
13.5	2.15	2.26	2.26	3.16	2.12	2.26	2.26	3.16
14.0	1.98	2.12	2.12	2.84	1.93	2.12	2.12	2.84
14.5	1.83	1.99	2.00	2.55	1.76	1.99	2.00	2.55
15.0	1.69	1.88	1.88	2.31	1.60	1.86	1.88	2.31
15.5	1.57	1.76	1.76	2.09	1.46	1.72	1.76	2.09
16.0	1.45	1.65	1.65	1.90	1.33	1.59	1.65	1.90
16.5	1.35	1.55	1.55	1.73	1.21	1.48	1.55	1.73
17.0	1.25	1.46	1.46	1.58	1.10	1.38	1.46	1.58
17.5	1.17	1.38	1.38	1.45	1.00	1.28	1.38	1.45
18.0	1.09	1.29	1.31	1.33	0.91	1.20	1.30	1.33

- 1B = One mid span brace
- 2B = Two equally spaced braces within the span
- 3B = Three equally spaced braces within the span
- w_u = Uniformly distributed serviceability load (kN/m) for deflection limit of Span/150
- $\phi_b w_u$ = Strength load resistance applied at the centroid (kN/m)

- 2-M12 Grade 4.6 bolts per connection
- 2-M12 Grade 8.8 bolts per connection
- 2-M16 Grade 4.6 bolts per connection
- 2-M16 Grade 8.8 bolts per connection

IMPORTANT

The adequacy of multispan system is very sensitive to actual applied loads. The stated loads in this table are assumed uniform over the full purlin system. Variations in actual project design loadings over the length of the purlin system must be checked specifically by the designer to verify system adequacy.

TWO SPAN LAPPED

LOAD TABLE – Uniformly Distributed Load

MSS 400/23								
SPAN (m)	INWARDS				OUTWARDS			
	$\phi_b w_u$ kN/m			w_s kN/m	$\phi_b w_u$ kN/m			w_s kN/m
	1B	2B	3B		1B	2B	3B	
3.0								
3.5								
4.0								
4.5								
5.0								
5.5								
6.0	11.1	11.1	11.1	41.36	11.1	11.1	11.1	41.36
6.5	9.88	9.88	9.88	32.53	9.88	9.88	9.88	32.53
7.0	8.85	8.85	8.85	26.05	8.85	8.85	8.85	26.05
7.5	7.97	7.96	7.97	21.18	7.97	7.96	7.97	21.18
8.0	7.20	7.20	7.20	17.45	7.20	7.20	7.20	17.45
8.5	6.54	6.54	6.54	14.55	6.54	6.54	6.54	14.55
9.0	5.96	5.96	5.96	12.26	5.96	5.96	5.96	12.26
9.5	5.46	5.46	5.46	10.42	5.46	5.46	5.46	10.42
10.0	5.01	5.01	5.01	8.93	5.01	5.01	5.01	8.93
10.5	4.61	4.61	4.61	7.72	4.61	4.61	4.61	7.72
11.0	4.26	4.26	4.26	6.71	4.26	4.26	4.26	6.71
11.5	3.85	3.90	3.90	5.87	3.90	3.90	3.90	5.87
12.0	3.49	3.58	3.58	5.17	3.57	3.58	3.58	5.17
12.5	3.18	3.30	3.30	4.57	3.23	3.30	3.30	4.57
13.0	2.90	3.05	3.05	4.07	2.93	3.05	3.05	4.07
13.5	2.66	2.83	2.83	3.63	2.66	2.83	2.83	3.63
14.0	2.44	2.63	2.63	3.26	2.41	2.63	2.63	3.26
14.5	2.25	2.45	2.45	2.93	2.20	2.45	2.45	2.93
15.0	2.07	2.29	2.29	2.65	2.00	2.29	2.29	2.65
15.5	1.92	2.15	2.15	2.40	1.82	2.15	2.15	2.40
16.0	1.78	2.01	2.01	2.18	1.66	2.01	2.01	2.18
16.5	1.65	1.89	1.89	1.99	1.51	1.88	1.89	1.99
17.0	1.53	1.78	1.78	1.82	1.38	1.74	1.78	1.82
17.5	1.43	1.68	1.68	1.67	1.26	1.62	1.68	1.67
18.0	1.33	1.59	1.59	1.53	1.15	1.51	1.59	1.53

MSS 400/24								
SPAN (m)	INWARDS				OUTWARDS			
	$\phi_b w_u$ kN/m			w_s kN/m	$\phi_b w_u$ kN/m			w_s kN/m
	1B	2B	3B		1B	2B	3B	
3.0								
3.5								
4.0								
4.5								
5.0								
5.5								
6.0	12.8	12.8	12.8	44.00	12.8	12.8	12.8	44.00
6.5	11.3	11.3	11.3	34.60	11.3	11.3	11.3	34.60
7.0	10.1	10.1	10.1	27.71	10.1	10.1	10.1	27.71
7.5	9.11	9.11	9.11	22.53	9.11	9.11	9.11	22.53
8.0	8.23	8.23	8.23	18.56	8.23	8.23	8.23	18.56
8.5	7.46	7.46	7.46	15.47	7.46	7.46	7.46	15.47
9.0	6.80	6.80	6.80	13.04	6.80	6.80	6.80	13.04
9.5	6.21	6.21	6.21	11.08	6.21	6.21	6.21	11.08
10.0	5.63	5.63	5.63	9.50	5.63	5.63	5.63	9.50
10.5	5.11	5.11	5.11	8.21	5.11	5.11	5.11	8.21
11.0	4.65	4.65	4.65	7.14	4.65	4.65	4.65	7.14
11.5	4.24	4.26	4.26	6.25	4.26	4.26	4.26	6.25
12.0	3.84	3.91	3.91	5.50	3.91	3.91	3.91	5.50
12.5	3.50	3.60	3.60	4.87	3.58	3.60	3.60	4.87
13.0	3.19	3.33	3.33	4.33	3.24	3.33	3.33	4.33
13.5	2.92	3.09	3.09	3.86	2.94	3.09	3.09	3.86
14.0	2.68	2.87	2.87	3.46	2.67	2.87	2.87	3.46
14.5	2.47	2.68	2.68	3.12	2.43	2.68	2.68	3.12
15.0	2.28	2.50	2.50	2.82	2.22	2.50	2.50	2.82
15.5	2.10	2.34	2.34	2.55	2.02	2.34	2.34	2.55
16.0	1.95	2.20	2.20	2.32	1.84	2.20	2.20	2.32
16.5	1.81	2.07	2.07	2.12	1.68	2.07	2.07	2.12
17.0	1.68	1.95	1.95	1.93	1.53	1.93	1.95	1.93
17.5	1.56	1.84	1.84	1.77	1.38	1.79	1.84	1.77
18.0	1.46	1.74	1.74	1.63	1.24	1.67	1.74	1.63

- 1B = One mid span brace
- 2B = Two equally spaced braces within the span
- 3B = Three equally spaced braces within the span
- w_s = Uniformly distributed serviceability load (kN/m) for deflection limit of Span/150
- $\phi_b w_u$ = Strength load resistance applied at the centroid (kN/m)

- 2-M12 Grade 4.6 bolts per connection
- 2-M12 Grade 8.8 bolts per connection
- 2-M16 Grade 4.6 bolts per connection
- 2-M16 Grade 8.8 bolts per connection

IMPORTANT

The adequacy of multispan system is very sensitive to actual applied loads. The stated loads in this table are assumed uniform over the full purlin system. Variations in actual project design loadings over the length of the purlin system must be checked specifically by the designer to verify system adequacy.

TWO SPAN LAPPED

LOAD TABLE – Uniformly Distributed Load

MSS 400/30								
SPAN (m)	INWARDS				OUTWARDS			
	$\phi_b w_u$ kN/m			w_s kN/m	$\phi_b w_u$ kN/m			w_s kN/m
	1B	2B	3B		1B	2B	3B	
3.0								
3.5								
4.0								
4.5								
5.0								
5.5								
6.0	15.6	15.6	15.6	53.62	15.6	15.6	15.6	53.62
6.5	14.4	14.4	14.4	42.17	14.4	14.4	14.4	42.17
7.0	13.4	13.4	13.4	33.76	13.4	13.4	13.4	33.76
7.5	12.5	12.5	12.5	27.45	12.5	12.5	12.5	27.45
8.0	11.7	11.7	11.7	22.62	11.7	11.7	11.7	22.62
8.5	10.3	10.3	10.3	18.86	10.3	10.3	10.3	18.86
9.0	9.21	9.21	9.21	15.89	9.21	9.21	9.21	15.89
9.5	8.26	8.26	8.26	13.51	8.26	8.26	8.26	13.51
10.0	7.46	7.46	7.46	11.58	7.46	7.46	7.46	11.58
10.5	6.77	6.77	6.77	10.00	6.77	6.77	6.77	10.00
11.0	6.16	6.16	6.16	8.70	6.16	6.16	6.16	8.70
11.5	5.62	5.64	5.64	7.61	5.64	5.64	5.64	7.61
12.0	5.06	5.18	5.18	6.70	5.18	5.18	5.18	6.70
12.5	4.56	4.77	4.77	5.93	4.77	4.77	4.77	5.93
13.0	4.13	4.41	4.41	5.27	4.37	4.41	4.41	5.27
13.5	3.75	4.09	4.09	4.71	3.93	4.09	4.09	4.71
14.0	3.41	3.81	3.81	4.22	3.53	3.81	3.81	4.22
14.5	3.11	3.55	3.55	3.80	3.18	3.55	3.55	3.80
15.0	2.85	3.32	3.32	3.43	2.87	3.32	3.32	3.43
15.5	2.61	3.10	3.10	3.11	2.58	3.10	3.10	3.11
16.0	2.39	2.91	2.91	2.83	2.32	2.91	2.91	2.83
16.5	2.20	2.74	2.74	2.58	2.09	2.74	2.74	2.58
17.0	2.03	2.58	2.58	2.36	1.87	2.58	2.58	2.36
17.5	1.87	2.44	2.44	2.16	1.68	2.44	2.44	2.16
18.0	1.73	2.30	2.30	1.99	1.51	2.24	2.30	1.99

- 1B = One mid span brace
 2B = Two equally spaced braces within the span
 3B = Three equally spaced braces within the span
 w_s = Uniformly distributed serviceability load (kN/m)
 for deflection limit of Span/150
 $\phi_b w_u$ = Strength load resistance applied at the
 centroid (kN/m)

- 2-M12 Grade 4.6 bolts per connection
- 2-M12 Grade 8.8 bolts per connection
- 2-M16 Grade 4.6 bolts per connection
- 2-M16 Grade 8.8 bolts per connection

IMPORTANT

The adequacy of multispan system is very sensitive to actual applied loads. The stated loads in this table are assumed uniform over the full purlin system. Variations in actual project design loadings over the length of the purlin system must be checked specifically by the designer to verify system adequacy.

THREE SPAN LAPPED

LOAD TABLE – Uniformly Distributed Load

MSS 150/12								
SPAN (m)	INWARDS				OUTWARDS			
	$\phi_b w_u$ kN/m			w_s kN/m	$\phi_b w_u$ kN/m			w_s kN/m
	1B	2B	3B		1B	2B	3B	
3.0	9.01	9.00	9.00	10.28	9.01	9.00	9.00	10.28
3.5	6.57	6.57	6.57	6.83	6.57	6.57	6.57	6.83
4.0	5.01	5.01	5.01	4.42	5.01	5.01	5.01	4.42
4.5	3.94	3.94	3.94	3.08	3.94	3.94	3.94	3.08
5.0	3.15	3.15	3.15	2.24	3.15	3.15	3.15	2.24
5.5	2.55	2.55	2.55	1.67	2.55	2.55	2.55	1.67
6.0	2.10	2.10	2.10	1.29	2.07	2.10	2.10	1.29
6.5	1.79	1.79	1.79	1.01	1.70	1.79	1.79	1.01
7.0	1.54	1.54	1.54	0.81	1.41	1.54	1.54	0.81
7.5	1.34	1.34	1.34	0.66	1.16	1.34	1.34	0.66
8.0	1.18	1.18	1.18	0.54	0.96	1.17	1.18	0.54
8.5	1.04	1.04	1.04	0.45	0.79	1.01	1.04	0.45
9.0	0.93	0.93	0.93	0.38	0.65	0.88	0.93	0.38
9.5	0.84	0.84	0.84	0.32	0.54	0.76	0.84	0.32
10.0	0.75	0.75	0.75	0.28	0.44	0.66	0.75	0.28
10.5	0.67	0.68	0.68	0.24	0.37	0.57	0.66	0.24
11.0	0.61	0.62	0.62	0.21	0.31	0.50	0.59	0.21
11.5								
12.0								
12.5								
13.0								
13.5								
14.0								
14.5								
15.0								
15.5								
16.0								
16.5								
17.0								
17.5								
18.0								

MSS 150/15								
SPAN (m)	INWARDS				OUTWARDS			
	$\phi_b w_u$ kN/m			w_s kN/m	$\phi_b w_u$ kN/m			w_s kN/m
	1B	2B	3B		1B	2B	3B	
3.0	12.3	12.3	12.3	12.83	12.3	12.3	12.3	12.83
3.5	8.99	8.98	8.99	8.52	8.99	8.98	8.99	8.52
4.0	6.85	6.85	6.85	5.51	6.85	6.85	6.85	5.51
4.5	5.39	5.39	5.39	3.85	5.39	5.39	5.39	3.85
5.0	4.31	4.31	4.31	2.79	4.31	4.31	4.31	2.79
5.5	3.48	3.48	3.48	2.09	3.48	3.48	3.48	2.09
6.0	2.87	2.87	2.87	1.60	2.83	2.87	2.87	1.60
6.5	2.44	2.44	2.44	1.26	2.31	2.44	2.44	1.26
7.0	2.11	2.11	2.11	1.01	1.90	2.11	2.11	1.01
7.5	1.83	1.83	1.83	0.82	1.56	1.83	1.83	0.82
8.0	1.61	1.61	1.61	0.68	1.29	1.61	1.61	0.68
8.5	1.43	1.43	1.43	0.56	1.06	1.38	1.43	0.56
9.0	1.27	1.27	1.27	0.48	0.87	1.19	1.27	0.48
9.5	1.13	1.14	1.14	0.40	0.71	1.03	1.14	0.40
10.0	1.01	1.03	1.03	0.35	0.59	0.89	1.02	0.35
10.5	0.90	0.94	0.94	0.30	0.49	0.77	0.91	0.30
11.0	0.81	0.85	0.85	0.26	0.41	0.67	0.80	0.26
11.5								
12.0								
12.5								
13.0								
13.5								
14.0								
14.5								
15.0								
15.5								
16.0								
16.5								
17.0								
17.5								
18.0								

- 1B = One mid span brace
- 2B = Two equally spaced braces within the span
- 3B = Three equally spaced braces within the span
- w_s = Uniformly distributed serviceability load (kN/m) for deflection limit of Span/150
- $\phi_b w_u$ = Strength load resistance applied at the centroid (kN/m)

- 2-M12 Grade 4.6 bolts per connection
- 2-M12 Grade 8.8 bolts per connection
- 2-M16 Grade 4.6 bolts per connection
- 2-M16 Grade 8.8 bolts per connection

IMPORTANT

The adequacy of multispan system is very sensitive to actual applied loads. The stated loads in this table are assumed uniform over the full purlin system. Variations in actual project design loadings over the length of the purlin system must be checked specifically by the designer to verify system adequacy.

THREE SPAN LAPPED

LOAD TABLE – Uniformly Distributed Load

MSS 150/18								
SPAN (m)	INWARDS				OUTWARDS			
	$\phi_b w_u$ kN/m			W_s kN/m	$\phi_b w_u$ kN/m			W_s kN/m
	1B	2B	3B		1B	2B	3B	
3.0	14.7	14.7	14.7	15.31	14.7	14.7	14.7	15.31
3.5	10.7	10.7	10.7	10.17	10.7	10.7	10.7	10.17
4.0	8.19	8.18	8.18	6.58	8.19	8.18	8.18	6.58
4.5	6.44	6.44	6.44	4.59	6.44	6.44	6.44	4.59
5.0	5.15	5.15	5.15	3.33	5.15	5.15	5.15	3.33
5.5	4.16	4.16	4.16	2.49	4.16	4.16	4.16	2.49
6.0	3.42	3.42	3.42	1.91	3.33	3.42	3.42	1.91
6.5	2.92	2.92	2.92	1.51	2.73	2.92	2.92	1.51
7.0	2.52	2.52	2.52	1.21	2.25	2.52	2.52	1.21
7.5	2.19	2.19	2.19	0.98	1.86	2.19	2.19	0.98
8.0	1.90	1.93	1.93	0.81	1.54	1.89	1.93	0.81
8.5	1.67	1.71	1.71	0.67	1.27	1.63	1.71	0.67
9.0	1.47	1.52	1.52	0.57	1.05	1.41	1.52	0.57
9.5	1.31	1.37	1.37	0.48	0.86	1.22	1.37	0.48
10.0	1.17	1.23	1.23	0.41	0.71	1.06	1.21	0.41
10.5	1.05	1.12	1.12	0.36	0.59	0.92	1.07	0.36
11.0	0.94	1.02	1.02	0.31	0.50	0.80	0.95	0.31
11.5								
12.0								
12.5								
13.0								
13.5								
14.0								
14.5								
15.0								
15.5								
16.0								
16.5								
17.0								
17.5								
18.0								

MSS 150/23								
SPAN (m)	INWARDS				OUTWARDS			
	$\phi_b w_u$ kN/m			W_s kN/m	$\phi_b w_u$ kN/m			W_s kN/m
	1B	2B	3B		1B	2B	3B	
3.0	20.3	20.2	20.3	19.36	20.3	20.2	20.3	19.36
3.5	14.8	14.8	14.8	12.86	14.8	14.8	14.8	12.86
4.0	11.3	11.3	11.3	8.32	11.3	11.3	11.3	8.32
4.5	8.85	8.86	8.86	5.81	8.87	8.86	8.86	5.81
5.0	6.95	7.09	7.09	4.21	6.89	7.09	7.09	4.21
5.5	5.53	5.73	5.73	3.15	5.39	5.73	5.73	3.15
6.0	4.49	4.71	4.71	2.42	4.28	4.71	4.71	2.42
6.5	3.77	4.02	4.02	1.90	3.49	3.99	4.02	1.90
7.0	3.20	3.46	3.46	1.52	2.87	3.36	3.46	1.52
7.5	2.74	3.02	3.02	1.24	2.37	2.85	3.02	1.24
8.0	2.38	2.65	2.65	1.02	1.96	2.43	2.64	1.02
8.5	2.08	2.35	2.35	0.85	1.63	2.09	2.29	0.85
9.0	1.83	2.08	2.10	0.72	1.35	1.80	2.00	0.72
9.5	1.62	1.85	1.88	0.61	1.12	1.56	1.76	0.61
10.0	1.44	1.65	1.70	0.52	0.92	1.35	1.55	0.52
10.5	1.29	1.49	1.54	0.45	0.77	1.17	1.37	0.45
11.0	1.16	1.35	1.40	0.39	0.65	1.02	1.21	0.39
11.5								
12.0								
12.5								
13.0								
13.5								
14.0								
14.5								
15.0								
15.5								
16.0								
16.5								
17.0								
17.5								
18.0								

- 1B = One mid span brace
- 2B = Two equally spaced braces within the span
- 3B = Three equally spaced braces within the span
- w_s = Uniformly distributed serviceability load (kN/m) for deflection limit of Span/150
- $\phi_b w_u$ = Strength load resistance applied at the centroid (kN/m)

- 2-M12 Grade 4.6 bolts per connection
- 2-M12 Grade 8.8 bolts per connection
- 2-M16 Grade 4.6 bolts per connection
- 2-M16 Grade 8.8 bolts per connection

IMPORTANT

The adequacy of multispan system is very sensitive to actual applied loads. The stated loads in this table are assumed uniform over the full purlin system. Variations in actual project design loadings over the length of the purlin system must be checked specifically by the designer to verify system adequacy.

THREE SPAN LAPPED

LOAD TABLE – Uniformly Distributed Load

MSS 200/12								
SPAN (m)	INWARDS				OUTWARDS			
	$\phi_b w_u$ kN/m			w_s kN/m	$\phi_b w_u$ kN/m			w_s kN/m
	1B	2B	3B		1B	2B	3B	
3.0	12.0	12.0	12.0	22.13	12.0	12.0	12.0	22.13
3.5	9.05	9.05	9.06	14.70	9.05	9.05	9.06	14.70
4.0	7.08	7.08	7.07	9.51	7.08	7.08	7.07	9.51
4.5	5.58	5.58	5.58	6.64	5.58	5.58	5.58	6.64
5.0	4.47	4.47	4.47	4.82	4.47	4.47	4.47	4.82
5.5	3.62	3.62	3.62	3.60	3.62	3.62	3.62	3.60
6.0	2.97	2.97	2.97	2.77	2.97	2.97	2.97	2.77
6.5	2.53	2.53	2.53	2.18	2.46	2.53	2.53	2.18
7.0	2.19	2.19	2.19	1.74	2.06	2.19	2.19	1.74
7.5	1.90	1.90	1.90	1.42	1.74	1.90	1.90	1.42
8.0	1.67	1.67	1.67	1.17	1.47	1.67	1.67	1.17
8.5	1.48	1.48	1.48	0.97	1.25	1.46	1.48	0.97
9.0	1.31	1.32	1.32	0.82	1.06	1.27	1.32	0.82
9.5	1.16	1.19	1.19	0.70	0.90	1.12	1.19	0.70
10.0	1.04	1.07	1.07	0.60	0.77	0.98	1.07	0.60
10.5	0.94	0.97	0.97	0.52	0.65	0.87	0.96	0.52
11.0	0.85	0.88	0.88	0.45	0.56	0.77	0.86	0.45
11.5	0.77	0.81	0.81	0.39	0.48	0.68	0.77	0.39
12.0	0.70	0.74	0.74	0.35	0.41	0.60	0.69	0.35
12.5	0.64	0.69	0.69	0.31	0.35	0.53	0.63	0.31
13.0	0.58	0.63	0.63	0.27	0.31	0.47	0.57	0.27
13.5	0.54	0.59	0.59	0.24	0.27	0.42	0.51	0.24
14.0	0.49	0.54	0.55	0.22	0.23	0.37	0.46	0.22
14.5	0.45	0.50	0.51	0.20	0.20	0.33	0.42	0.20
15.0	0.42	0.46	0.48	0.18	0.18	0.30	0.38	0.18
15.5								
16.0								
16.5								
17.0								
17.5								
18.0								

MSS 200/15								
SPAN (m)	INWARDS				OUTWARDS			
	$\phi_b w_u$ kN/m			w_s kN/m	$\phi_b w_u$ kN/m			w_s kN/m
	1B	2B	3B		1B	2B	3B	
3.0	17.6	17.6	17.6	27.61	17.6	17.6	17.6	27.61
3.5	12.9	12.9	12.9	18.34	12.9	12.9	12.9	18.34
4.0	9.80	9.80	9.80	11.87	9.80	9.80	9.80	11.87
4.5	7.71	7.71	7.71	8.28	7.71	7.71	7.71	8.28
5.0	6.17	6.17	6.17	6.01	6.17	6.17	6.17	6.01
5.5	4.98	4.98	4.98	4.50	4.98	4.98	4.98	4.50
6.0	4.10	4.10	4.10	3.45	4.10	4.10	4.10	3.45
6.5	3.49	3.49	3.49	2.72	3.49	3.49	3.49	2.72
7.0	3.01	3.01	3.01	2.17	3.01	3.01	3.01	2.17
7.5	2.62	2.62	2.62	1.77	2.56	2.62	2.62	1.77
8.0	2.31	2.31	2.31	1.46	2.17	2.31	2.31	1.46
8.5	2.04	2.04	2.04	1.21	1.83	2.04	2.04	1.21
9.0	1.82	1.82	1.82	1.02	1.53	1.82	1.82	1.02
9.5	1.64	1.64	1.64	0.87	1.28	1.64	1.64	0.87
10.0	1.48	1.48	1.48	0.75	1.07	1.45	1.48	0.75
10.5	1.34	1.34	1.34	0.64	0.89	1.28	1.34	0.64
11.0	1.22	1.22	1.22	0.56	0.75	1.13	1.22	0.56
11.5	1.10	1.12	1.12	0.49	0.64	1.00	1.12	0.49
12.0	1.00	1.03	1.03	0.43	0.54	0.88	1.02	0.43
12.5	0.92	0.94	0.94	0.38	0.47	0.77	0.92	0.38
13.0	0.84	0.87	0.87	0.34	0.40	0.67	0.84	0.34
13.5	0.77	0.81	0.81	0.30	0.35	0.58	0.76	0.30
14.0	0.71	0.75	0.75	0.27	0.30	0.51	0.68	0.27
14.5	0.65	0.70	0.70	0.24	0.27	0.45	0.62	0.24
15.0	0.60	0.66	0.66	0.22	0.23	0.40	0.55	0.22
15.5								
16.0								
16.5								
17.0								
17.5								
18.0								

- 1B = One mid span brace
- 2B = Two equally spaced braces within the span
- 3B = Three equally spaced braces within the span
- w_s = Uniformly distributed serviceability load (kN/m) for deflection limit of Span/150
- $\phi_b w_u$ = Strength load resistance applied at the centroid (kN/m)

- 2-M12 Grade 4.6 bolts per connection
- 2-M12 Grade 8.8 bolts per connection
- 2-M16 Grade 4.6 bolts per connection
- 2-M16 Grade 8.8 bolts per connection

IMPORTANT

The adequacy of multispan system is very sensitive to actual applied loads. The stated loads in this table are assumed uniform over the full purlin system. Variations in actual project design loadings over the length of the purlin system must be checked specifically by the designer to verify system adequacy.

THREE SPAN LAPPED

LOAD TABLE – Uniformly Distributed Load

MSS 200/18								
SPAN (m)	INWARDS				OUTWARDS			
	$\phi_b w_u$ kN/m			W_s kN/m	$\phi_b w_u$ kN/m			W_s kN/m
	1B	2B	3B		1B	2B	3B	
3.0	21.3	21.3	21.3	33.09	21.3	21.3	21.3	33.09
3.5	15.5	15.5	15.5	21.98	15.5	15.5	15.5	21.98
4.0	11.8	11.8	11.8	14.22	11.8	11.8	11.8	14.22
4.5	9.31	9.31	9.31	9.93	9.31	9.31	9.31	9.93
5.0	7.45	7.45	7.45	7.20	7.45	7.45	7.45	7.20
5.5	6.02	6.02	6.02	5.39	6.02	6.02	6.02	5.39
6.0	4.95	4.95	4.95	4.14	4.95	4.95	4.95	4.14
6.5	4.22	4.22	4.22	3.25	4.22	4.22	4.22	3.25
7.0	3.64	3.64	3.64	2.61	3.64	3.64	3.64	2.61
7.5	3.17	3.17	3.17	2.12	3.11	3.17	3.17	2.12
8.0	2.78	2.78	2.78	1.75	2.61	2.78	2.78	1.75
8.5	2.47	2.47	2.47	1.46	2.21	2.47	2.47	1.46
9.0	2.20	2.20	2.20	1.23	1.86	2.20	2.20	1.23
9.5	1.97	1.97	1.97	1.04	1.57	1.97	1.97	1.04
10.0	1.78	1.78	1.78	0.89	1.33	1.77	1.78	0.89
10.5	1.61	1.62	1.62	0.77	1.11	1.55	1.62	0.77
11.0	1.45	1.47	1.47	0.67	0.93	1.37	1.47	0.67
11.5	1.31	1.35	1.35	0.59	0.78	1.21	1.35	0.59
12.0	1.19	1.24	1.24	0.52	0.66	1.06	1.24	0.52
12.5	1.08	1.14	1.14	0.46	0.57	0.94	1.12	0.46
13.0	0.99	1.05	1.05	0.41	0.49	0.83	1.01	0.41
13.5	0.90	0.98	0.98	0.36	0.42	0.73	0.91	0.36
14.0	0.83	0.91	0.91	0.33	0.37	0.64	0.82	0.33
14.5	0.76	0.85	0.85	0.29	0.32	0.56	0.75	0.29
15.0	0.70	0.79	0.79	0.26	0.28	0.49	0.67	0.26
15.5								
16.0								
16.5								
17.0								
17.5								
18.0								

MSS 200/23								
SPAN (m)	INWARDS				OUTWARDS			
	$\phi_b w_u$ kN/m			W_s kN/m	$\phi_b w_u$ kN/m			W_s kN/m
	1B	2B	3B		1B	2B	3B	
3.0	29.7	29.7	29.7	41.86	29.7	29.7	29.7	41.86
3.5	21.7	21.7	21.7	27.81	21.7	21.7	21.7	27.81
4.0	16.5	16.5	16.5	17.99	16.5	16.5	16.5	17.99
4.5	13.0	13.0	13.0	12.56	13.0	13.0	13.0	12.56
5.0	10.4	10.4	10.4	9.11	10.4	10.4	10.4	9.11
5.5	8.40	8.40	8.40	6.82	8.40	8.40	8.40	6.82
6.0	6.91	6.91	6.91	5.23	6.90	6.91	6.91	5.23
6.5	5.83	5.89	5.89	4.12	5.77	5.89	5.89	4.12
7.0	4.98	5.08	5.08	3.30	4.84	5.08	5.08	3.30
7.5	4.29	4.42	4.42	2.68	4.10	4.42	4.42	2.68
8.0	3.73	3.89	3.89	2.21	3.44	3.89	3.89	2.21
8.5	3.26	3.44	3.44	1.84	2.89	3.41	3.44	1.84
9.0	2.88	3.07	3.07	1.55	2.43	2.99	3.07	1.55
9.5	2.56	2.76	2.76	1.32	2.04	2.63	2.76	1.32
10.0	2.28	2.49	2.49	1.13	1.71	2.33	2.49	1.13
10.5	2.04	2.26	2.26	0.98	1.42	2.05	2.23	0.98
11.0	1.83	2.06	2.06	0.85	1.19	1.80	2.01	0.85
11.5	1.65	1.88	1.88	0.74	1.01	1.58	1.81	0.74
12.0	1.49	1.72	1.73	0.65	0.86	1.39	1.64	0.65
12.5	1.36	1.57	1.59	0.58	0.73	1.22	1.48	0.58
13.0	1.23	1.45	1.47	0.51	0.63	1.07	1.34	0.51
13.5	1.13	1.34	1.37	0.46	0.55	0.94	1.20	0.46
14.0	1.03	1.24	1.27	0.41	0.48	0.82	1.08	0.41
14.5	0.95	1.15	1.18	0.37	0.42	0.72	0.97	0.37
15.0	0.87	1.06	1.11	0.34	0.37	0.63	0.88	0.34
15.5								
16.0								
16.5								
17.0								
17.5								
18.0								

- 1B = One mid span brace
- 2B = Two equally spaced braces within the span
- 3B = Three equally spaced braces within the span
- w_s = Uniformly distributed serviceability load (kN/m) for deflection limit of Span/150
- $\phi_b w_u$ = Strength load resistance applied at the centroid (kN/m)

- 2-M12 Grade 4.6 bolts per connection
- 2-M12 Grade 8.8 bolts per connection
- 2-M16 Grade 4.6 bolts per connection
- 2-M16 Grade 8.8 bolts per connection

IMPORTANT

The adequacy of multispan system is very sensitive to actual applied loads. The stated loads in this table are assumed uniform over the full purlin system. Variations in actual project design loadings over the length of the purlin system must be checked specifically by the designer to verify system adequacy.

THREE SPAN LAPPED

LOAD TABLE – Uniformly Distributed Load

MSS 250/13								
SPAN (m)	INWARDS				OUTWARDS			
	$\phi_b w_u$ kN/m			w_s kN/m	$\phi_b w_u$ kN/m			w_s kN/m
	1B	2B	3B		1B	2B	3B	
3.0								
3.5								
4.0	9.48	9.48	9.48	19.12	9.48	9.48	9.48	19.12
4.5	7.63	7.63	7.63	13.35	7.63	7.63	7.63	13.35
5.0	6.34	6.34	6.33	9.68	6.34	6.34	6.33	9.68
5.5	5.31	5.31	5.31	7.25	5.31	5.31	5.31	7.25
6.0	4.48	4.48	4.48	5.56	4.48	4.48	4.48	5.56
6.5	3.89	3.89	3.89	4.38	3.85	3.89	3.89	4.38
7.0	3.34	3.39	3.39	3.50	3.25	3.39	3.39	3.50
7.5	2.88	2.98	2.98	2.85	2.76	2.98	2.98	2.85
8.0	2.51	2.62	2.62	2.35	2.36	2.60	2.62	2.35
8.5	2.20	2.32	2.32	1.96	2.03	2.27	2.32	1.96
9.0	1.95	2.07	2.07	1.65	1.76	2.00	2.07	1.65
9.5	1.73	1.86	1.86	1.40	1.52	1.76	1.86	1.40
10.0	1.55	1.68	1.68	1.20	1.32	1.56	1.66	1.20
10.5	1.40	1.52	1.52	1.04	1.15	1.39	1.49	1.04
11.0	1.26	1.38	1.39	0.90	0.99	1.24	1.34	0.90
11.5	1.14	1.26	1.27	0.79	0.86	1.11	1.21	0.79
12.0	1.04	1.15	1.17	0.70	0.75	1.00	1.10	0.70
12.5	0.95	1.05	1.07	0.62	0.66	0.90	1.00	0.62
13.0	0.87	0.97	0.99	0.55	0.58	0.81	0.91	0.55
13.5	0.80	0.89	0.92	0.49	0.51	0.73	0.83	0.49
14.0	0.74	0.83	0.86	0.44	0.46	0.65	0.76	0.44
14.5	0.68	0.77	0.80	0.39	0.41	0.59	0.69	0.39
15.0	0.63	0.71	0.74	0.36	0.36	0.53	0.63	0.36
15.5	0.59	0.66	0.69	0.32	0.32	0.48	0.58	0.32
16.0	0.54	0.61	0.65	0.29	0.29	0.43	0.53	0.29
16.5	0.51	0.57	0.61	0.27	0.25	0.39	0.49	0.27
17.0	0.47	0.54	0.57	0.24	0.23	0.35	0.45	0.24
17.5								
18.0								

MSS 250/15								
SPAN (m)	INWARDS				OUTWARDS			
	$\phi_b w_u$ kN/m			w_s kN/m	$\phi_b w_u$ kN/m			w_s kN/m
	1B	2B	3B		1B	2B	3B	
3.0								
3.5								
4.0	12.7	12.7	12.7	22.06	12.7	12.7	12.7	22.06
4.5	10.1	10.1	10.1	15.40	10.1	10.1	10.1	15.40
5.0	8.36	8.36	8.35	11.17	8.36	8.36	8.35	11.17
5.5	6.92	6.92	6.92	8.36	6.92	6.92	6.92	8.36
6.0	5.73	5.73	5.73	6.42	5.73	5.73	5.73	6.42
6.5	4.88	4.88	4.88	5.05	4.85	4.88	4.88	5.05
7.0	4.17	4.21	4.21	4.04	4.10	4.21	4.21	4.04
7.5	3.60	3.66	3.66	3.29	3.48	3.66	3.66	3.29
8.0	3.13	3.22	3.22	2.71	2.98	3.22	3.22	2.71
8.5	2.75	2.85	2.85	2.26	2.57	2.85	2.85	2.26
9.0	2.43	2.55	2.55	1.90	2.22	2.52	2.55	1.90
9.5	2.16	2.28	2.28	1.62	1.92	2.23	2.28	1.62
10.0	1.93	2.06	2.06	1.39	1.67	1.97	2.06	1.39
10.5	1.73	1.87	1.87	1.20	1.45	1.76	1.87	1.20
11.0	1.56	1.70	1.70	1.04	1.26	1.57	1.69	1.04
11.5	1.42	1.56	1.56	0.91	1.10	1.41	1.53	0.91
12.0	1.29	1.43	1.43	0.80	0.95	1.26	1.39	0.80
12.5	1.18	1.32	1.32	0.71	0.84	1.13	1.26	0.71
13.0	1.08	1.21	1.22	0.63	0.73	1.02	1.15	0.63
13.5	0.99	1.12	1.13	0.56	0.64	0.92	1.05	0.56
14.0	0.91	1.04	1.05	0.51	0.56	0.83	0.96	0.51
14.5	0.84	0.96	0.98	0.45	0.49	0.75	0.88	0.45
15.0	0.78	0.89	0.92	0.41	0.43	0.67	0.80	0.41
15.5	0.72	0.83	0.86	0.37	0.38	0.61	0.74	0.37
16.0	0.67	0.77	0.81	0.34	0.34	0.55	0.68	0.34
16.5	0.62	0.72	0.76	0.31	0.30	0.49	0.62	0.31
17.0	0.58	0.67	0.71	0.28	0.27	0.45	0.57	0.28
17.5								
18.0								

- 1B = One mid span brace
- 2B = Two equally spaced braces within the span
- 3B = Three equally spaced braces within the span
- w_s = Uniformly distributed serviceability load (kN/m) for deflection limit of Span/150
- $\phi_b w_u$ = Strength load resistance applied at the centroid (kN/m)

- 2-M12 Grade 4.6 bolts per connection
- 2-M12 Grade 8.8 bolts per connection
- 2-M16 Grade 4.6 bolts per connection
- 2-M16 Grade 8.8 bolts per connection

IMPORTANT

The adequacy of multispan system is very sensitive to actual applied loads. The stated loads in this table are assumed uniform over the full purlin system. Variations in actual project design loadings over the length of the purlin system must be checked specifically by the designer to verify system adequacy.

THREE SPAN LAPPED

LOAD TABLE – Uniformly Distributed Load

MSS 250/18								
SPAN (m)	INWARDS				OUTWARDS			
	$\phi_b w_u$ kN/m			w_s kN/m	$\phi_b w_u$ kN/m			w_s kN/m
	1B	2B	3B		1B	2B	3B	
3.0								
3.5								
4.0	16.6	16.6	16.6	26.44	16.6	16.6	16.6	26.44
4.5	13.1	13.1	13.1	18.46	13.1	13.1	13.1	18.46
5.0	10.5	10.5	10.5	13.39	10.5	10.5	10.5	13.39
5.5	8.45	8.45	8.45	10.02	8.45	8.45	8.45	10.02
6.0	6.95	6.95	6.95	7.69	6.95	6.95	6.95	7.69
6.5	5.92	5.92	5.92	6.05	5.92	5.92	5.92	6.05
7.0	5.11	5.11	5.11	4.84	5.11	5.11	5.11	4.84
7.5	4.45	4.45	4.45	3.94	4.45	4.45	4.45	3.94
8.0	3.91	3.91	3.91	3.25	3.88	3.91	3.91	3.25
8.5	3.46	3.46	3.46	2.71	3.36	3.46	3.46	2.71
9.0	3.09	3.09	3.09	2.28	2.91	3.09	3.09	2.28
9.5	2.75	2.77	2.77	1.94	2.54	2.77	2.77	1.94
10.0	2.46	2.50	2.50	1.66	2.21	2.50	2.50	1.66
10.5	2.21	2.27	2.27	1.44	1.91	2.27	2.27	1.44
11.0	2.00	2.07	2.07	1.25	1.66	2.04	2.07	1.25
11.5	1.81	1.89	1.89	1.09	1.43	1.84	1.89	1.09
12.0	1.65	1.74	1.74	0.96	1.23	1.66	1.74	0.96
12.5	1.51	1.60	1.60	0.85	1.06	1.49	1.60	0.85
13.0	1.38	1.48	1.48	0.76	0.92	1.35	1.48	0.76
13.5	1.27	1.37	1.37	0.68	0.80	1.22	1.36	0.68
14.0	1.17	1.28	1.28	0.61	0.70	1.10	1.25	0.61
14.5	1.08	1.19	1.19	0.55	0.61	0.98	1.15	0.55
15.0	1.00	1.11	1.11	0.49	0.54	0.88	1.05	0.49
15.5	0.93	1.04	1.04	0.45	0.47	0.79	0.97	0.45
16.0	0.86	0.98	0.98	0.41	0.42	0.71	0.89	0.41
16.5	0.80	0.92	0.92	0.37	0.37	0.63	0.83	0.37
17.0	0.74	0.87	0.87	0.34	0.33	0.57	0.76	0.34
17.5								
18.0								

MSS 250/23								
SPAN (m)	INWARDS				OUTWARDS			
	$\phi_b w_u$ kN/m			w_s kN/m	$\phi_b w_u$ kN/m			w_s kN/m
	1B	2B	3B		1B	2B	3B	
3.0								
3.5								
4.0	23.3	23.3	23.3	33.60	23.3	23.3	23.3	33.60
4.5	18.3	18.3	18.3	23.46	18.3	18.3	18.3	23.46
5.0	14.7	14.7	14.7	17.02	14.7	14.7	14.7	17.02
5.5	11.8	11.8	11.8	12.73	11.8	11.8	11.8	12.73
6.0	9.74	9.74	9.74	9.78	9.74	9.74	9.74	9.78
6.5	8.30	8.30	8.30	7.69	8.30	8.30	8.30	7.69
7.0	7.16	7.16	7.16	6.16	7.16	7.16	7.16	6.16
7.5	6.24	6.24	6.24	5.00	6.24	6.24	6.24	5.00
8.0	5.48	5.48	5.48	4.12	5.48	5.48	5.48	4.12
8.5	4.85	4.85	4.85	3.44	4.72	4.85	4.85	3.44
9.0	4.29	4.33	4.33	2.90	4.06	4.33	4.33	2.90
9.5	3.79	3.89	3.89	2.46	3.50	3.89	3.89	2.46
10.0	3.37	3.51	3.51	2.11	3.02	3.51	3.51	2.11
10.5	3.01	3.18	3.18	1.82	2.60	3.18	3.18	1.82
11.0	2.70	2.90	2.90	1.59	2.23	2.90	2.90	1.59
11.5	2.43	2.65	2.65	1.39	1.90	2.59	2.65	1.39
12.0	2.20	2.44	2.44	1.22	1.63	2.32	2.44	1.22
12.5	2.00	2.24	2.24	1.08	1.39	2.07	2.24	1.08
13.0	1.82	2.08	2.08	0.96	1.19	1.86	2.08	0.96
13.5	1.67	1.92	1.92	0.86	1.03	1.67	1.92	0.86
14.0	1.53	1.79	1.79	0.77	0.90	1.49	1.77	0.77
14.5	1.40	1.67	1.67	0.69	0.78	1.33	1.61	0.69
15.0	1.29	1.56	1.56	0.63	0.69	1.19	1.47	0.63
15.5	1.19	1.46	1.46	0.57	0.61	1.06	1.35	0.57
16.0	1.10	1.37	1.37	0.52	0.54	0.94	1.23	0.52
16.5	1.02	1.29	1.29	0.47	0.48	0.84	1.13	0.47
17.0	0.94	1.21	1.21	0.43	0.43	0.74	1.03	0.43
17.5								
18.0								

- 1B = One mid span brace
- 2B = Two equally spaced braces within the span
- 3B = Three equally spaced braces within the span
- w_s = Uniformly distributed serviceability load (kN/m) for deflection limit of Span/150
- $\phi_b w_u$ = Strength load resistance applied at the centroid (kN/m)

- 2-M12 Grade 4.6 bolts per connection
- 2-M12 Grade 8.8 bolts per connection
- 2-M16 Grade 4.6 bolts per connection
- 2-M16 Grade 8.8 bolts per connection

IMPORTANT

The adequacy of multispan system is very sensitive to actual applied loads. The stated loads in this table are assumed uniform over the full purlin system. Variations in actual project design loadings over the length of the purlin system must be checked specifically by the designer to verify system adequacy.

THREE SPAN LAPPED

LOAD TABLE – Uniformly Distributed Load

MSS 275/15								
SPAN (m)	INWARDS				OUTWARDS			
	$\phi_b w_u$ kN/m			w_s kN/m	$\phi_b w_u$ kN/m			w_s kN/m
	1B	2B	3B		1B	2B	3B	
3.0								
3.5								
4.0								
4.5	9.65	9.65	9.65	19.92	9.65	9.65	9.65	19.92
5.0	8.12	8.12	8.11	14.45	8.12	8.12	8.11	14.45
5.5	6.88	6.88	6.88	10.81	6.88	6.88	6.88	10.81
6.0	5.87	5.88	5.87	8.30	5.87	5.88	5.87	8.30
6.5	5.16	5.16	5.16	6.53	5.16	5.16	5.16	6.53
7.0	4.56	4.56	4.56	5.23	4.56	4.56	4.56	5.23
7.5	4.01	4.06	4.06	4.25	3.94	4.06	4.06	4.25
8.0	3.49	3.60	3.60	3.50	3.38	3.60	3.60	3.50
8.5	3.06	3.19	3.19	2.92	2.91	3.19	3.19	2.92
9.0	2.70	2.85	2.85	2.46	2.53	2.84	2.85	2.46
9.5	2.40	2.56	2.56	2.09	2.20	2.51	2.56	2.09
10.0	2.15	2.31	2.31	1.79	1.91	2.23	2.31	1.79
10.5	1.93	2.09	2.09	1.55	1.67	1.99	2.09	1.55
11.0	1.74	1.91	1.91	1.35	1.46	1.78	1.91	1.35
11.5	1.58	1.74	1.74	1.18	1.27	1.60	1.73	1.18
12.0	1.44	1.60	1.60	1.04	1.11	1.44	1.56	1.04
12.5	1.31	1.47	1.48	0.92	0.97	1.29	1.42	0.92
13.0	1.20	1.35	1.37	0.82	0.86	1.17	1.30	0.82
13.5	1.10	1.25	1.27	0.73	0.76	1.05	1.19	0.73
14.0	1.02	1.16	1.18	0.65	0.67	0.95	1.09	0.65
14.5	0.94	1.07	1.10	0.59	0.60	0.86	0.99	0.59
15.0	0.87	1.00	1.03	0.53	0.53	0.78	0.91	0.53
15.5	0.81	0.93	0.96	0.48	0.47	0.70	0.84	0.48
16.0	0.75	0.86	0.90	0.44	0.42	0.64	0.77	0.44
16.5	0.70	0.81	0.85	0.40	0.37	0.57	0.71	0.40
17.0	0.65	0.75	0.79	0.37	0.34	0.52	0.66	0.37
17.5								
18.0								

MSS 275/18								
SPAN (m)	INWARDS				OUTWARDS			
	$\phi_b w_u$ kN/m			w_s kN/m	$\phi_b w_u$ kN/m			w_s kN/m
	1B	2B	3B		1B	2B	3B	
3.0								
3.5								
4.0								
4.5	13.7	13.7	13.7	23.89	13.7	13.7	13.7	23.89
5.0	11.3	11.3	11.3	17.33	11.3	11.3	11.3	17.33
5.5	9.47	9.47	9.47	12.96	9.47	9.47	9.47	12.96
6.0	7.79	7.79	7.79	9.95	7.79	7.79	7.79	9.95
6.5	6.64	6.64	6.64	7.83	6.64	6.64	6.64	7.83
7.0	5.73	5.73	5.73	6.27	5.73	5.73	5.73	6.27
7.5	4.99	4.99	4.99	5.10	4.99	4.99	4.99	5.10
8.0	4.38	4.38	4.38	4.20	4.37	4.38	4.38	4.20
8.5	3.88	3.88	3.88	3.50	3.79	3.88	3.88	3.50
9.0	3.44	3.46	3.46	2.95	3.30	3.46	3.46	2.95
9.5	3.06	3.11	3.11	2.51	2.88	3.11	3.11	2.51
10.0	2.73	2.81	2.81	2.15	2.53	2.81	2.81	2.15
10.5	2.46	2.55	2.55	1.86	2.22	2.55	2.55	1.86
11.0	2.22	2.32	2.32	1.62	1.95	2.31	2.32	1.62
11.5	2.01	2.12	2.12	1.41	1.72	2.07	2.12	1.41
12.0	1.83	1.95	1.95	1.24	1.51	1.87	1.95	1.24
12.5	1.67	1.80	1.80	1.10	1.30	1.69	1.80	1.10
13.0	1.53	1.66	1.66	0.98	1.13	1.53	1.66	0.98
13.5	1.41	1.54	1.54	0.87	0.98	1.39	1.54	0.87
14.0	1.30	1.43	1.43	0.78	0.86	1.26	1.41	0.78
14.5	1.20	1.33	1.33	0.71	0.76	1.15	1.30	0.71
15.0	1.11	1.25	1.25	0.64	0.67	1.05	1.19	0.64
15.5	1.03	1.17	1.17	0.58	0.59	0.95	1.10	0.58
16.0	0.96	1.10	1.10	0.52	0.52	0.87	1.02	0.52
16.5	0.89	1.03	1.03	0.48	0.46	0.78	0.94	0.48
17.0	0.83	0.97	0.97	0.44	0.41	0.70	0.87	0.44
17.5								
18.0								

- 1B = One mid span brace
- 2B = Two equally spaced braces within the span
- 3B = Three equally spaced braces within the span
- w_s = Uniformly distributed serviceability load (kN/m) for deflection limit of Span/150
- $\phi_b w_u$ = Strength load resistance applied at the centroid (kN/m)

- 2-M12 Grade 4.6 bolts per connection
- 2-M12 Grade 8.8 bolts per connection
- 2-M16 Grade 4.6 bolts per connection
- 2-M16 Grade 8.8 bolts per connection

IMPORTANT

The adequacy of multispan system is very sensitive to actual applied loads. The stated loads in this table are assumed uniform over the full purlin system. Variations in actual project design loadings over the length of the purlin system must be checked specifically by the designer to verify system adequacy.

THREE SPAN LAPPED

LOAD TABLE – Uniformly Distributed Load

MSS 300/15								
SPAN (m)	INWARDS				OUTWARDS			
	$\phi_b w_u$ kN/m			w_s kN/m	$\phi_b w_u$ kN/m			w_s kN/m
	1B	2B	3B		1B	2B	3B	
3.0								
3.5								
4.0								
4.5								
5.0	8.05	8.05	8.04	19.01	8.05	8.05	8.04	19.01
5.5	6.92	6.92	6.92	14.22	6.92	6.92	6.92	14.22
6.0	5.98	5.99	5.98	10.92	5.98	5.99	5.98	10.92
6.5	5.31	5.30	5.30	8.59	5.31	5.30	5.30	8.59
7.0	4.73	4.73	4.73	6.88	4.73	4.73	4.73	6.88
7.5	4.24	4.24	4.24	5.59	4.24	4.24	4.24	5.59
8.0	3.82	3.82	3.82	4.61	3.82	3.82	3.82	4.61
8.5	3.46	3.46	3.46	3.84	3.46	3.46	3.46	3.84
9.0	3.15	3.15	3.15	3.24	3.06	3.15	3.15	3.24
9.5	2.79	2.87	2.87	2.75	2.68	2.87	2.87	2.75
10.0	2.50	2.62	2.62	2.36	2.36	2.62	2.62	2.36
10.5	2.24	2.40	2.40	2.04	2.08	2.37	2.40	2.04
11.0	2.02	2.20	2.20	1.77	1.83	2.13	2.20	1.77
11.5	1.83	2.02	2.02	1.55	1.62	1.92	2.02	1.55
12.0	1.67	1.85	1.85	1.36	1.43	1.74	1.85	1.36
12.5	1.52	1.70	1.71	1.21	1.27	1.57	1.69	1.21
13.0	1.40	1.57	1.58	1.07	1.12	1.43	1.55	1.07
13.5	1.28	1.45	1.46	0.96	0.99	1.30	1.42	0.96
14.0	1.18	1.34	1.36	0.86	0.88	1.18	1.30	0.86
14.5	1.09	1.24	1.27	0.77	0.78	1.08	1.20	0.77
15.0	1.01	1.16	1.18	0.70	0.70	0.98	1.11	0.70
15.5	0.94	1.08	1.11	0.63	0.62	0.90	1.02	0.63
16.0	0.87	1.01	1.04	0.58	0.56	0.82	0.95	0.58
16.5	0.81	0.94	0.98	0.53	0.51	0.75	0.87	0.53
17.0	0.76	0.88	0.92	0.48	0.46	0.68	0.81	0.48
17.5	0.71	0.83	0.86	0.44	0.42	0.62	0.75	0.44
18.0	0.66	0.78	0.81	0.40	0.38	0.57	0.70	0.40

MSS 300/18								
SPAN (m)	INWARDS				OUTWARDS			
	$\phi_b w_u$ kN/m			w_s kN/m	$\phi_b w_u$ kN/m			w_s kN/m
	1B	2B	3B		1B	2B	3B	
3.0								
3.5								
4.0								
4.5								
5.0	11.6	11.6	11.6	22.80	11.6	11.6	11.6	22.80
5.5	9.85	9.85	9.85	17.06	9.85	9.85	9.85	17.06
6.0	8.42	8.43	8.42	13.10	8.42	8.43	8.42	13.10
6.5	7.41	7.41	7.41	10.30	7.41	7.41	7.41	10.30
7.0	6.56	6.56	6.56	8.25	6.56	6.56	6.56	8.25
7.5	5.78	5.78	5.78	6.71	5.78	5.78	5.78	6.71
8.0	5.08	5.08	5.08	5.52	5.08	5.08	5.08	5.52
8.5	4.50	4.50	4.50	4.61	4.50	4.50	4.50	4.61
9.0	3.99	4.01	4.01	3.88	3.95	4.01	4.01	3.88
9.5	3.55	3.60	3.60	3.30	3.47	3.60	3.60	3.30
10.0	3.17	3.25	3.25	2.83	3.06	3.25	3.25	2.83
10.5	2.85	2.95	2.95	2.44	2.71	2.95	2.95	2.44
11.0	2.57	2.69	2.69	2.13	2.41	2.69	2.69	2.13
11.5	2.33	2.46	2.46	1.86	2.14	2.46	2.46	1.86
12.0	2.12	2.26	2.26	1.64	1.90	2.24	2.26	1.64
12.5	1.93	2.08	2.08	1.45	1.69	2.03	2.08	1.45
13.0	1.77	1.92	1.92	1.29	1.50	1.85	1.92	1.29
13.5	1.63	1.78	1.78	1.15	1.34	1.69	1.78	1.15
14.0	1.50	1.66	1.66	1.03	1.19	1.54	1.66	1.03
14.5	1.39	1.55	1.55	0.93	1.06	1.41	1.55	0.93
15.0	1.28	1.44	1.44	0.84	0.93	1.29	1.43	0.84
15.5	1.19	1.35	1.35	0.76	0.83	1.18	1.32	0.76
16.0	1.11	1.27	1.27	0.69	0.74	1.08	1.22	0.69
16.5	1.03	1.19	1.19	0.63	0.66	0.99	1.14	0.63
17.0	0.96	1.12	1.13	0.58	0.59	0.91	1.06	0.58
17.5	0.90	1.05	1.06	0.53	0.53	0.84	0.98	0.53
18.0	0.84	0.99	1.00	0.49	0.48	0.77	0.91	0.49

- 1B = One mid span brace
- 2B = Two equally spaced braces within the span
- 3B = Three equally spaced braces within the span
- w_s = Uniformly distributed serviceability load (kN/m) for deflection limit of Span/150
- $\phi_b w_u$ = Strength load resistance applied at the centroid (kN/m)

- 2-M12 Grade 4.6 bolts per connection
- 2-M12 Grade 8.8 bolts per connection
- 2-M16 Grade 4.6 bolts per connection
- 2-M16 Grade 8.8 bolts per connection

IMPORTANT

The adequacy of multispan system is very sensitive to actual applied loads. The stated loads in this table are assumed uniform over the full purlin system. Variations in actual project design loadings over the length of the purlin system must be checked specifically by the designer to verify system adequacy.

THREE SPAN LAPPED

LOAD TABLE – Uniformly Distributed Load

MSS 300/23								
SPAN (m)	INWARDS				OUTWARDS			
	$\phi_b w_u$ kN/m			w_s kN/m	$\phi_b w_u$ kN/m			w_s kN/m
	1B	2B	3B		1B	2B	3B	
3.0								
3.5								
4.0								
4.5								
5.0	19.2	19.1	19.1	29.00	19.2	19.1	19.1	29.00
5.5	15.5	15.5	15.5	21.70	15.5	15.5	15.5	21.70
6.0	12.7	12.7	12.7	16.66	12.7	12.7	12.7	16.66
6.5	10.9	10.9	10.9	13.10	10.9	10.9	10.9	13.10
7.0	9.36	9.36	9.36	10.49	9.36	9.36	9.36	10.49
7.5	8.15	8.15	8.15	8.53	8.15	8.15	8.15	8.53
8.0	7.17	7.17	7.17	7.03	7.17	7.17	7.17	7.03
8.5	6.35	6.35	6.35	5.86	6.35	6.35	6.35	5.86
9.0	5.66	5.66	5.66	4.94	5.66	5.66	5.66	4.94
9.5	5.08	5.08	5.08	4.20	5.08	5.08	5.08	4.20
10.0	4.59	4.59	4.59	3.60	4.58	4.59	4.59	3.60
10.5	4.16	4.16	4.16	3.11	4.02	4.16	4.16	3.11
11.0	3.73	3.79	3.79	2.70	3.54	3.79	3.79	2.70
11.5	3.36	3.47	3.47	2.37	3.11	3.47	3.47	2.37
12.0	3.03	3.18	3.18	2.08	2.74	3.18	3.18	2.08
12.5	2.75	2.94	2.94	1.84	2.41	2.94	2.94	1.84
13.0	2.50	2.71	2.71	1.64	2.12	2.71	2.71	1.64
13.5	2.29	2.52	2.52	1.46	1.86	2.52	2.52	1.46
14.0	2.09	2.34	2.34	1.31	1.63	2.30	2.34	1.31
14.5	1.92	2.18	2.18	1.18	1.43	2.09	2.18	1.18
15.0	1.77	2.04	2.04	1.07	1.26	1.90	2.04	1.07
15.5	1.63	1.91	1.91	0.97	1.11	1.73	1.91	0.97
16.0	1.51	1.79	1.79	0.88	0.98	1.57	1.79	0.88
16.5	1.40	1.68	1.68	0.80	0.87	1.43	1.68	0.80
17.0	1.30	1.59	1.59	0.73	0.77	1.30	1.58	0.73
17.5	1.21	1.50	1.50	0.67	0.69	1.18	1.46	0.67
18.0	1.12	1.42	1.42	0.62	0.62	1.07	1.35	0.62

MSS 300/24								
SPAN (m)	INWARDS				OUTWARDS			
	$\phi_b w_u$ kN/m			w_s kN/m	$\phi_b w_u$ kN/m			w_s kN/m
	1B	2B	3B		1B	2B	3B	
3.0								
3.5								
4.0								
4.5								
5.0	21.0	21.0	21.0	30.86	21.0	21.0	21.0	30.86
5.5	16.9	16.9	16.9	23.09	16.9	16.9	16.9	23.09
6.0	13.9	13.9	13.9	17.73	13.9	13.9	13.9	17.73
6.5	11.9	11.9	11.9	13.95	11.9	11.9	11.9	13.95
7.0	10.2	10.2	10.2	11.17	10.2	10.2	10.2	11.17
7.5	8.92	8.92	8.92	9.08	8.92	8.92	8.92	9.08
8.0	7.84	7.84	7.84	7.48	7.84	7.84	7.84	7.48
8.5	6.94	6.94	6.94	6.24	6.94	6.94	6.94	6.24
9.0	6.19	6.19	6.19	5.25	6.19	6.19	6.19	5.25
9.5	5.56	5.56	5.56	4.47	5.56	5.56	5.56	4.47
10.0	4.99	5.02	5.02	3.83	4.94	5.02	5.02	3.83
10.5	4.45	4.55	4.55	3.31	4.34	4.55	4.55	3.31
11.0	3.99	4.15	4.15	2.88	3.82	4.15	4.15	2.88
11.5	3.59	3.79	3.79	2.52	3.36	3.79	3.79	2.52
12.0	3.24	3.48	3.48	2.22	2.96	3.48	3.48	2.22
12.5	2.94	3.21	3.21	1.96	2.60	3.21	3.21	1.96
13.0	2.67	2.97	2.97	1.74	2.29	2.97	2.97	1.74
13.5	2.44	2.75	2.75	1.56	2.01	2.73	2.75	1.56
14.0	2.23	2.56	2.56	1.40	1.75	2.48	2.56	1.40
14.5	2.04	2.39	2.39	1.26	1.53	2.25	2.39	1.26
15.0	1.88	2.23	2.23	1.13	1.34	2.05	2.23	1.13
15.5	1.73	2.09	2.09	1.03	1.18	1.87	2.09	1.03
16.0	1.60	1.96	1.96	0.94	1.04	1.70	1.96	0.94
16.5	1.48	1.84	1.84	0.85	0.93	1.55	1.84	0.85
17.0	1.37	1.74	1.74	0.78	0.83	1.41	1.70	0.78
17.5	1.28	1.64	1.64	0.71	0.74	1.28	1.58	0.71
18.0	1.19	1.55	1.55	0.66	0.66	1.16	1.46	0.66

- 1B = One mid span brace
- 2B = Two equally spaced braces within the span
- 3B = Three equally spaced braces within the span
- w_s = Uniformly distributed serviceability load (kN/m) for deflection limit of Span/150
- $\phi_b w_u$ = Strength load resistance applied at the centroid (kN/m)

- 2-M12 Grade 4.6 bolts per connection
- 2-M12 Grade 8.8 bolts per connection
- 2-M16 Grade 4.6 bolts per connection
- 2-M16 Grade 8.8 bolts per connection

IMPORTANT

The adequacy of multispan system is very sensitive to actual applied loads. The stated loads in this table are assumed uniform over the full purlin system. Variations in actual project design loadings over the length of the purlin system must be checked specifically by the designer to verify system adequacy.

THREE SPAN LAPPED

LOAD TABLE – Uniformly Distributed Load

MSS 300/30								
SPAN (m)	INWARDS				OUTWARDS			
	$\phi_b w_u$ kN/m			w_s kN/m	$\phi_b w_u$ kN/m			w_s kN/m
	1B	2B	3B		1B	2B	3B	
3.0								
3.5								
4.0								
4.5								
5.0	21.5	21.5	21.5	37.51	21.5	21.5	21.5	37.51
5.5	19.5	19.5	19.5	28.07	19.5	19.5	19.5	28.07
6.0	17.9	17.9	17.9	21.55	17.9	17.9	17.9	21.55
6.5	15.6	15.6	15.6	16.95	15.6	15.6	15.6	16.95
7.0	13.5	13.5	13.5	13.57	13.5	13.5	13.5	13.57
7.5	11.7	11.7	11.7	11.03	11.7	11.7	11.7	11.03
8.0	10.3	10.3	10.3	9.09	10.3	10.3	10.3	9.09
8.5	9.13	9.13	9.13	7.58	9.13	9.13	9.13	7.58
9.0	8.00	8.14	8.14	6.38	8.14	8.14	8.14	6.38
9.5	7.01	7.31	7.31	5.43	7.20	7.31	7.31	5.43
10.0	6.19	6.59	6.59	4.65	6.28	6.59	6.59	4.65
10.5	5.48	5.98	5.98	4.02	5.48	5.98	5.98	4.02
11.0	4.88	5.45	5.45	3.50	4.80	5.45	5.45	3.50
11.5	4.37	4.99	4.99	3.06	4.21	4.99	4.99	3.06
12.0	3.92	4.58	4.58	2.69	3.68	4.58	4.58	2.69
12.5	3.53	4.22	4.22	2.38	3.23	4.22	4.22	2.38
13.0	3.20	3.90	3.90	2.12	2.82	3.83	3.90	2.12
13.5	2.90	3.62	3.62	1.89	2.46	3.47	3.62	1.89
14.0	2.64	3.36	3.36	1.70	2.14	3.14	3.36	1.70
14.5	2.41	3.14	3.14	1.53	1.87	2.84	3.14	1.53
15.0	2.20	2.93	2.93	1.38	1.64	2.58	2.93	1.38
15.5	2.02	2.73	2.75	1.25	1.45	2.34	2.75	1.25
16.0	1.85	2.54	2.58	1.14	1.28	2.12	2.54	1.14
16.5	1.71	2.36	2.42	1.04	1.14	1.92	2.34	1.04
17.0	1.57	2.20	2.28	0.95	1.02	1.74	2.16	0.95
17.5	1.45	2.05	2.15	0.87	0.91	1.58	1.99	0.87
18.0	1.35	1.92	2.04	0.80	0.82	1.43	1.84	0.80

MSS 325/15								
SPAN (m)	INWARDS				OUTWARDS			
	$\phi_b w_u$ kN/m			w_s kN/m	$\phi_b w_u$ kN/m			w_s kN/m
	1B	2B	3B		1B	2B	3B	
3.0								
3.5								
4.0								
4.5								
5.0	8.17	8.17	8.15	22.94	8.17	8.17	8.15	22.94
5.5	7.06	7.06	7.06	17.17	7.06	7.06	7.06	17.17
6.0	6.14	6.14	6.14	13.18	6.14	6.14	6.14	13.18
6.5	5.47	5.47	5.47	10.37	5.47	5.47	5.47	10.37
7.0	4.90	4.90	4.90	8.30	4.90	4.90	4.90	8.30
7.5	4.41	4.41	4.41	6.75	4.41	4.41	4.41	6.75
8.0	3.99	3.99	3.98	5.56	3.99	3.99	3.98	5.56
8.5	3.62	3.62	3.62	4.64	3.62	3.62	3.62	4.64
9.0	3.30	3.30	3.30	3.91	3.30	3.30	3.30	3.91
9.5	3.02	3.02	3.02	3.32	2.91	3.02	3.02	3.32
10.0	2.71	2.77	2.77	2.85	2.56	2.77	2.77	2.85
10.5	2.43	2.55	2.55	2.46	2.25	2.55	2.55	2.46
11.0	2.19	2.35	2.35	2.14	1.99	2.32	2.35	2.14
11.5	1.99	2.17	2.17	1.87	1.76	2.09	2.17	1.87
12.0	1.81	2.01	2.01	1.65	1.55	1.89	2.01	1.65
12.5	1.65	1.85	1.85	1.46	1.37	1.71	1.84	1.46
13.0	1.51	1.71	1.71	1.30	1.21	1.55	1.69	1.30
13.5	1.39	1.58	1.59	1.16	1.07	1.41	1.55	1.16
14.0	1.28	1.46	1.48	1.04	0.94	1.28	1.42	1.04
14.5	1.18	1.35	1.38	0.93	0.84	1.17	1.31	0.93
15.0	1.09	1.26	1.29	0.84	0.75	1.07	1.20	0.84
15.5	1.01	1.17	1.20	0.76	0.67	0.97	1.11	0.76
16.0	0.94	1.09	1.13	0.70	0.60	0.89	1.03	0.70
16.5	0.88	1.02	1.06	0.63	0.55	0.81	0.95	0.63
17.0	0.82	0.96	1.00	0.58	0.49	0.74	0.88	0.58
17.5	0.76	0.90	0.94	0.53	0.45	0.67	0.82	0.53
18.0	0.71	0.85	0.89	0.49	0.41	0.61	0.76	0.49

- 1B = One mid span brace
- 2B = Two equally spaced braces within the span
- 3B = Three equally spaced braces within the span
- w_s = Uniformly distributed serviceability load (kN/m) for deflection limit of Span/150
- $\phi_b w_u$ = Strength load resistance applied at the centroid (kN/m)

- 2-M12 Grade 4.6 bolts per connection
- 2-M12 Grade 8.8 bolts per connection
- 2-M16 Grade 4.6 bolts per connection
- 2-M16 Grade 8.8 bolts per connection

IMPORTANT

The adequacy of multispan system is very sensitive to actual applied loads. The stated loads in this table are assumed uniform over the full purlin system. Variations in actual project design loadings over the length of the purlin system must be checked specifically by the designer to verify system adequacy.

THREE SPAN LAPPED

LOAD TABLE – Uniformly Distributed Load

MSS 325/18								
SPAN (m)	INWARDS				OUTWARDS			
	$\phi_b w_u$ kN/m			w_s kN/m	$\phi_b w_u$ kN/m			w_s kN/m
	1B	2B	3B		1B	2B	3B	
3.0								
3.5								
4.0								
4.5								
5.0	11.9	11.9	11.8	27.53	11.9	11.9	11.8	27.53
5.5	10.1	10.1	10.1	20.60	10.1	10.1	10.1	20.60
6.0	8.72	8.73	8.72	15.82	8.72	8.73	8.72	15.82
6.5	7.71	7.71	7.71	12.44	7.71	7.71	7.71	12.44
7.0	6.85	6.85	6.85	9.96	6.85	6.85	6.85	9.96
7.5	6.13	6.13	6.13	8.10	6.13	6.13	6.13	8.10
8.0	5.51	5.51	5.50	6.67	5.51	5.51	5.50	6.67
8.5	4.89	4.89	4.89	5.56	4.89	4.89	4.89	5.56
9.0	4.33	4.36	4.36	4.69	4.29	4.36	4.36	4.69
9.5	3.84	3.91	3.91	3.98	3.77	3.91	3.91	3.98
10.0	3.43	3.53	3.53	3.42	3.32	3.53	3.53	3.42
10.5	3.08	3.20	3.20	2.95	2.94	3.20	3.20	2.95
11.0	2.78	2.92	2.92	2.57	2.60	2.92	2.92	2.57
11.5	2.52	2.67	2.67	2.25	2.31	2.67	2.67	2.25
12.0	2.29	2.45	2.45	1.98	2.05	2.43	2.45	1.98
12.5	2.09	2.26	2.26	1.75	1.82	2.20	2.26	1.75
13.0	1.91	2.09	2.09	1.56	1.62	2.01	2.09	1.56
13.5	1.76	1.94	1.94	1.39	1.44	1.83	1.94	1.39
14.0	1.62	1.80	1.80	1.25	1.28	1.67	1.80	1.25
14.5	1.49	1.68	1.68	1.12	1.14	1.53	1.68	1.12
15.0	1.38	1.57	1.57	1.01	1.02	1.40	1.55	1.01
15.5	1.28	1.47	1.47	0.92	0.91	1.28	1.43	0.92
16.0	1.19	1.38	1.38	0.83	0.81	1.17	1.33	0.83
16.5	1.11	1.29	1.30	0.76	0.72	1.07	1.23	0.76
17.0	1.03	1.21	1.22	0.70	0.65	0.98	1.14	0.70
17.5	0.97	1.14	1.15	0.64	0.58	0.90	1.06	0.64
18.0	0.90	1.07	1.09	0.59	0.52	0.82	0.99	0.59

MSS 350/18								
SPAN (m)	INWARDS				OUTWARDS			
	$\phi_b w_u$ kN/m			w_s kN/m	$\phi_b w_u$ kN/m			w_s kN/m
	1B	2B	3B		1B	2B	3B	
3.0								
3.5								
4.0								
4.5								
5.0								
5.5								
6.0	8.26	8.27	8.26	19.15	8.26	8.27	8.26	19.15
6.5	7.38	7.37	7.37	15.06	7.38	7.37	7.37	15.06
7.0	6.62	6.62	6.62	12.06	6.62	6.62	6.62	12.06
7.5	5.97	5.96	5.97	9.80	5.97	5.96	5.97	9.80
8.0	5.41	5.41	5.40	8.08	5.41	5.41	5.40	8.08
8.5	4.92	4.91	4.91	6.73	4.92	4.91	4.91	6.73
9.0	4.49	4.49	4.49	5.67	4.49	4.49	4.49	5.67
9.5	4.11	4.11	4.11	4.82	4.11	4.11	4.11	4.82
10.0	3.78	3.78	3.78	4.14	3.71	3.78	3.78	4.14
10.5	3.42	3.49	3.48	3.57	3.28	3.49	3.48	3.57
11.0	3.08	3.22	3.22	3.11	2.91	3.22	3.22	3.11
11.5	2.78	2.98	2.98	2.72	2.58	2.98	2.98	2.72
12.0	2.53	2.74	2.74	2.39	2.30	2.71	2.74	2.39
12.5	2.31	2.53	2.53	2.12	2.04	2.47	2.53	2.12
13.0	2.11	2.34	2.34	1.88	1.82	2.25	2.34	1.88
13.5	1.93	2.17	2.17	1.68	1.62	2.05	2.17	1.68
14.0	1.78	2.01	2.01	1.51	1.44	1.87	2.01	1.51
14.5	1.64	1.88	1.88	1.36	1.28	1.71	1.87	1.36
15.0	1.52	1.75	1.76	1.23	1.14	1.56	1.73	1.23
15.5	1.41	1.63	1.64	1.11	1.03	1.43	1.61	1.11
16.0	1.31	1.53	1.54	1.01	0.92	1.31	1.49	1.01
16.5	1.22	1.43	1.45	0.92	0.83	1.20	1.38	0.92
17.0	1.13	1.34	1.37	0.84	0.76	1.10	1.28	0.84
17.5	1.06	1.26	1.29	0.77	0.68	1.01	1.19	0.77
18.0	0.99	1.19	1.22	0.71	0.61	0.93	1.11	0.71

- 1B = One mid span brace
- 2B = Two equally spaced braces within the span
- 3B = Three equally spaced braces within the span
- w_s = Uniformly distributed serviceability load (kN/m) for deflection limit of Span/150
- $\phi_b w_u$ = Strength load resistance applied at the centroid (kN/m)

- 2-M12 Grade 4.6 bolts per connection
- 2-M12 Grade 8.8 bolts per connection
- 2-M16 Grade 4.6 bolts per connection
- 2-M16 Grade 8.8 bolts per connection

IMPORTANT

The adequacy of multispan system is very sensitive to actual applied loads. The stated loads in this table are assumed uniform over the full purlin system. Variations in actual project design loadings over the length of the purlin system must be checked specifically by the designer to verify system adequacy.

THREE SPAN LAPPED

LOAD TABLE – Uniformly Distributed Load

MSS 350/23								
SPAN (m)	INWARDS				OUTWARDS			
	$\phi_b w_u$ kN/m			w_s kN/m	$\phi_b w_u$ kN/m			w_s kN/m
	1B	2B	3B		1B	2B	3B	
3.0								
3.5								
4.0								
4.5								
5.0								
5.5								
6.0	14.0	14.0	14.0	24.39	14.0	14.0	14.0	24.39
6.5	12.4	12.4	12.4	19.18	12.4	12.4	12.4	19.18
7.0	11.0	11.0	11.0	15.36	11.0	11.0	11.0	15.36
7.5	9.90	9.89	9.90	12.49	9.90	9.89	9.90	12.49
8.0	8.72	8.72	8.72	10.29	8.72	8.72	8.72	10.29
8.5	7.72	7.72	7.72	8.58	7.72	7.72	7.72	8.58
9.0	6.89	6.89	6.89	7.23	6.89	6.89	6.89	7.23
9.5	6.18	6.18	6.18	6.14	6.18	6.18	6.18	6.14
10.0	5.54	5.58	5.58	5.27	5.52	5.58	5.58	5.27
10.5	4.96	5.06	5.06	4.55	4.89	5.06	5.06	4.55
11.0	4.46	4.61	4.61	3.96	4.34	4.61	4.61	3.96
11.5	4.02	4.22	4.22	3.46	3.86	4.22	4.22	3.46
12.0	3.65	3.87	3.87	3.05	3.44	3.87	3.87	3.05
12.5	3.32	3.57	3.57	2.70	3.06	3.57	3.57	2.70
13.0	3.03	3.30	3.30	2.40	2.71	3.30	3.30	2.40
13.5	2.77	3.06	3.06	2.14	2.38	3.05	3.06	2.14
14.0	2.54	2.85	2.85	1.92	2.09	2.78	2.85	1.92
14.5	2.34	2.65	2.65	1.73	1.83	2.54	2.65	1.73
15.0	2.16	2.48	2.48	1.56	1.62	2.33	2.48	1.56
15.5	2.00	2.32	2.32	1.41	1.42	2.14	2.32	1.41
16.0	1.85	2.18	2.18	1.29	1.26	1.96	2.18	1.29
16.5	1.72	2.05	2.05	1.17	1.11	1.80	2.05	1.17
17.0	1.59	1.93	1.93	1.07	0.99	1.65	1.91	1.07
17.5	1.48	1.82	1.82	0.98	0.89	1.51	1.77	0.98
18.0	1.37	1.72	1.72	0.90	0.79	1.38	1.65	0.90

MSS 350/24								
SPAN (m)	INWARDS				OUTWARDS			
	$\phi_b w_u$ kN/m			w_s kN/m	$\phi_b w_u$ kN/m			w_s kN/m
	1B	2B	3B		1B	2B	3B	
3.0								
3.5								
4.0								
4.5								
5.0								
5.5								
6.0	15.9	15.9	15.9	25.94	15.9	15.9	15.9	25.94
6.5	14.1	14.1	14.1	20.40	14.1	14.1	14.1	20.40
7.0	12.4	12.4	12.4	16.33	12.4	12.4	12.4	16.33
7.5	10.8	10.8	10.8	13.28	10.8	10.8	10.8	13.28
8.0	9.52	9.52	9.52	10.94	9.52	9.52	9.52	10.94
8.5	8.43	8.43	8.43	9.12	8.43	8.43	8.43	9.12
9.0	7.52	7.52	7.52	7.69	7.52	7.52	7.52	7.69
9.5	6.75	6.75	6.75	6.53	6.75	6.75	6.75	6.53
10.0	6.09	6.09	6.09	5.60	6.09	6.09	6.09	5.60
10.5	5.47	5.53	5.53	4.84	5.43	5.53	5.53	4.84
11.0	4.92	5.04	5.04	4.21	4.82	5.04	5.04	4.21
11.5	4.44	4.61	4.61	3.68	4.28	4.61	4.61	3.68
12.0	4.02	4.23	4.23	3.24	3.77	4.23	4.23	3.24
12.5	3.65	3.90	3.90	2.87	3.32	3.90	3.90	2.87
13.0	3.31	3.61	3.61	2.55	2.92	3.61	3.61	2.55
13.5	3.02	3.34	3.34	2.28	2.57	3.34	3.34	2.28
14.0	2.76	3.11	3.11	2.04	2.25	3.09	3.11	2.04
14.5	2.52	2.90	2.90	1.84	1.96	2.83	2.90	1.84
15.0	2.32	2.71	2.71	1.66	1.72	2.59	2.71	1.66
15.5	2.13	2.54	2.54	1.50	1.51	2.37	2.54	1.50
16.0	1.97	2.38	2.38	1.37	1.34	2.16	2.38	1.37
16.5	1.82	2.24	2.24	1.25	1.19	1.97	2.24	1.25
17.0	1.68	2.11	2.11	1.14	1.06	1.80	2.11	1.14
17.5	1.56	1.99	1.99	1.05	0.94	1.63	1.97	1.05
18.0	1.45	1.88	1.88	0.96	0.85	1.49	1.83	0.96

- 1B = One mid span brace
- 2B = Two equally spaced braces within the span
- 3B = Three equally spaced braces within the span
- w_s = Uniformly distributed serviceability load (kN/m) for deflection limit of Span/150
- $\phi_b w_u$ = Strength load resistance applied at the centroid (kN/m)

- 2-M12 Grade 4.6 bolts per connection
- 2-M12 Grade 8.8 bolts per connection
- 2-M16 Grade 4.6 bolts per connection
- 2-M16 Grade 8.8 bolts per connection

IMPORTANT

The adequacy of multispan system is very sensitive to actual applied loads. The stated loads in this table are assumed uniform over the full purlin system. Variations in actual project design loadings over the length of the purlin system must be checked specifically by the designer to verify system adequacy.

THREE SPAN LAPPED

LOAD TABLE – Uniformly Distributed Load

MSS 350/30								
SPAN (m)	INWARDS				OUTWARDS			
	$\phi_b w_u$ kN/m			w_s kN/m	$\phi_b w_u$ kN/m			w_s kN/m
	1B	2B	3B		1B	2B	3B	
3.0								
3.5								
4.0								
4.5								
5.0								
5.5								
6.0	17.9	17.9	17.9	31.58	17.9	17.9	17.9	31.58
6.5	16.5	16.5	16.5	24.84	16.5	16.5	16.5	24.84
7.0	15.3	15.3	15.3	19.89	15.3	15.3	15.3	19.89
7.5	14.3	14.3	14.3	16.17	14.3	14.3	14.3	16.17
8.0	12.6	12.6	12.6	13.32	12.6	12.6	12.6	13.32
8.5	11.1	11.1	11.1	11.11	11.1	11.1	11.1	11.11
9.0	9.93	9.93	9.93	9.36	9.93	9.93	9.93	9.36
9.5	8.76	8.91	8.91	7.96	8.91	8.91	8.91	7.96
10.0	7.72	8.04	8.04	6.82	7.95	8.04	8.04	6.82
10.5	6.83	7.30	7.30	5.89	6.95	7.30	7.30	5.89
11.0	6.07	6.65	6.65	5.12	6.09	6.65	6.65	5.12
11.5	5.42	6.08	6.08	4.48	5.35	6.08	6.08	4.48
12.0	4.86	5.59	5.59	3.95	4.69	5.59	5.59	3.95
12.5	4.37	5.15	5.15	3.49	4.11	5.15	5.15	3.49
13.0	3.94	4.76	4.76	3.10	3.60	4.76	4.76	3.10
13.5	3.57	4.41	4.41	2.77	3.15	4.39	4.41	2.77
14.0	3.24	4.10	4.10	2.49	2.75	3.98	4.10	2.49
14.5	2.95	3.83	3.83	2.24	2.40	3.61	3.83	2.24
15.0	2.69	3.57	3.57	2.02	2.10	3.28	3.57	2.02
15.5	2.46	3.35	3.35	1.83	1.85	2.97	3.35	1.83
16.0	2.25	3.14	3.14	1.67	1.64	2.70	3.14	1.67
16.5	2.07	2.94	2.95	1.52	1.45	2.45	2.95	1.52
17.0	1.90	2.74	2.78	1.39	1.29	2.23	2.74	1.39
17.5	1.76	2.55	2.63	1.27	1.16	2.02	2.53	1.27
18.0	1.62	2.39	2.48	1.17	1.04	1.83	2.34	1.17

MSS 400/20								
SPAN (m)	INWARDS				OUTWARDS			
	$\phi_b w_u$ kN/m			w_s kN/m	$\phi_b w_u$ kN/m			w_s kN/m
	1B	2B	3B		1B	2B	3B	
3.0								
3.5								
4.0								
4.5								
5.0								
5.5								
6.0	9.26	9.27	9.25	29.63	9.26	9.27	9.25	29.63
6.5	8.36	8.36	8.36	23.30	8.36	8.36	8.36	23.30
7.0	7.58	7.58	7.58	18.66	7.58	7.58	7.58	18.66
7.5	6.91	6.90	6.91	15.17	6.91	6.90	6.91	15.17
8.0	6.31	6.32	6.31	12.50	6.31	6.32	6.31	12.50
8.5	5.80	5.79	5.79	10.42	5.80	5.79	5.79	10.42
9.0	5.34	5.34	5.34	8.78	5.34	5.34	5.34	8.78
9.5	4.93	4.93	4.93	7.46	4.93	4.93	4.93	7.46
10.0	4.57	4.57	4.57	6.40	4.57	4.57	4.57	6.40
10.5	4.24	4.24	4.24	5.53	4.24	4.24	4.24	5.53
11.0	3.95	3.94	3.94	4.81	3.95	3.94	3.94	4.81
11.5	3.68	3.68	3.68	4.21	3.59	3.68	3.68	4.21
12.0	3.40	3.44	3.44	3.70	3.19	3.44	3.44	3.70
12.5	3.10	3.22	3.22	3.28	2.84	3.22	3.22	3.28
13.0	2.84	3.02	3.02	2.91	2.53	3.02	3.02	2.91
13.5	2.60	2.84	2.84	2.60	2.25	2.80	2.84	2.60
14.0	2.39	2.67	2.67	2.33	2.00	2.56	2.67	2.33
14.5	2.20	2.52	2.52	2.10	1.78	2.35	2.52	2.10
15.0	2.03	2.36	2.37	1.90	1.59	2.16	2.36	1.90
15.5	1.88	2.20	2.22	1.72	1.42	1.99	2.18	1.72
16.0	1.74	2.06	2.09	1.56	1.28	1.82	2.03	1.56
16.5	1.62	1.92	1.96	1.42	1.16	1.67	1.88	1.42
17.0	1.50	1.80	1.85	1.30	1.05	1.53	1.75	1.30
17.5	1.40	1.69	1.74	1.19	0.94	1.41	1.63	1.19
18.0	1.31	1.59	1.65	1.10	0.85	1.29	1.52	1.10

- 1B = One mid span brace
- 2B = Two equally spaced braces within the span
- 3B = Three equally spaced braces within the span
- w_s = Uniformly distributed serviceability load (kN/m) for deflection limit of Span/150
- $\phi_b w_u$ = Strength load resistance applied at the centroid (kN/m)

- 2-M12 Grade 4.6 bolts per connection
- 2-M12 Grade 8.8 bolts per connection
- 2-M16 Grade 4.6 bolts per connection
- 2-M16 Grade 8.8 bolts per connection

IMPORTANT

The adequacy of multispan system is very sensitive to actual applied loads. The stated loads in this table are assumed uniform over the full purlin system. Variations in actual project design loadings over the length of the purlin system must be checked specifically by the designer to verify system adequacy.

THREE SPAN LAPPED

LOAD TABLE – Uniformly Distributed Load

MSS 400/23								
SPAN (m)	INWARDS				OUTWARDS			
	$\phi_b w_u$ kN/m			w_s kN/m	$\phi_b w_u$ kN/m			w_s kN/m
	1B	2B	3B		1B	2B	3B	
3.0								
3.5								
4.0								
4.5								
5.0								
5.5								
6.0	12.8	12.8	12.8	34.01	12.8	12.8	12.8	34.01
6.5	11.5	11.5	11.5	26.75	11.5	11.5	11.5	26.75
7.0	10.4	10.4	10.4	21.42	10.4	10.4	10.4	21.42
7.5	9.44	9.43	9.44	17.41	9.44	9.43	9.44	17.41
8.0	8.60	8.61	8.60	14.35	8.60	8.61	8.60	14.35
8.5	7.88	7.87	7.87	11.96	7.88	7.87	7.87	11.96
9.0	7.23	7.23	7.23	10.08	7.23	7.23	7.23	10.08
9.5	6.66	6.66	6.66	8.57	6.66	6.66	6.66	8.57
10.0	6.15	6.15	6.15	7.35	6.15	6.15	6.15	7.35
10.5	5.70	5.70	5.69	6.35	5.69	5.70	5.69	6.35
11.0	5.14	5.29	5.29	5.52	5.05	5.29	5.29	5.52
11.5	4.63	4.92	4.92	4.83	4.49	4.92	4.92	4.83
12.0	4.19	4.52	4.52	4.25	3.99	4.52	4.52	4.25
12.5	3.81	4.17	4.17	3.76	3.56	4.17	4.17	3.76
13.0	3.47	3.85	3.85	3.34	3.17	3.85	3.85	3.34
13.5	3.17	3.57	3.57	2.99	2.82	3.55	3.57	2.99
14.0	2.91	3.32	3.32	2.68	2.51	3.24	3.32	2.68
14.5	2.67	3.10	3.10	2.41	2.24	2.96	3.10	2.41
15.0	2.46	2.89	2.89	2.18	1.98	2.71	2.89	2.18
15.5	2.28	2.71	2.71	1.97	1.75	2.49	2.71	1.97
16.0	2.11	2.54	2.54	1.79	1.54	2.28	2.54	1.79
16.5	1.95	2.39	2.39	1.64	1.37	2.09	2.39	1.64
17.0	1.82	2.25	2.25	1.50	1.22	1.92	2.22	1.50
17.5	1.69	2.12	2.13	1.37	1.09	1.77	2.06	1.37
18.0	1.58	1.99	2.01	1.26	0.97	1.62	1.92	1.26

MSS 400/24								
SPAN (m)	INWARDS				OUTWARDS			
	$\phi_b w_u$ kN/m			w_s kN/m	$\phi_b w_u$ kN/m			w_s kN/m
	1B	2B	3B		1B	2B	3B	
3.0								
3.5								
4.0								
4.5								
5.0								
5.5								
6.0	14.8	14.8	14.8	36.17	14.8	14.8	14.8	36.17
6.5	13.3	13.3	13.3	28.45	13.3	13.3	13.3	28.45
7.0	12.0	12.0	12.0	22.78	12.0	12.0	12.0	22.78
7.5	10.9	10.9	10.9	18.52	10.9	10.9	10.9	18.52
8.0	9.89	9.89	9.88	15.26	9.89	9.89	9.88	15.26
8.5	9.04	9.03	9.03	12.72	9.04	9.03	9.03	12.72
9.0	8.29	8.29	8.29	10.72	8.29	8.29	8.29	10.72
9.5	7.62	7.62	7.62	9.11	7.62	7.62	7.62	9.11
10.0	7.03	7.03	7.03	7.81	7.03	7.03	7.03	7.81
10.5	6.30	6.45	6.45	6.75	6.31	6.45	6.45	6.75
11.0	5.65	5.88	5.88	5.87	5.59	5.88	5.88	5.87
11.5	5.09	5.38	5.38	5.14	4.97	5.38	5.38	5.14
12.0	4.60	4.94	4.94	4.52	4.43	4.94	4.94	4.52
12.5	4.18	4.55	4.55	4.00	3.94	4.55	4.55	4.00
13.0	3.81	4.21	4.21	3.56	3.51	4.21	4.21	3.56
13.5	3.48	3.90	3.90	3.18	3.13	3.90	3.90	3.18
14.0	3.19	3.63	3.63	2.85	2.77	3.59	3.63	2.85
14.5	2.93	3.38	3.38	2.56	2.41	3.28	3.38	2.56
15.0	2.69	3.16	3.16	2.32	2.11	3.01	3.16	2.32
15.5	2.49	2.96	2.96	2.10	1.86	2.76	2.96	2.10
16.0	2.30	2.78	2.78	1.91	1.64	2.53	2.78	1.91
16.5	2.13	2.61	2.61	1.74	1.45	2.32	2.61	1.74
17.0	1.98	2.46	2.46	1.59	1.29	2.13	2.46	1.59
17.5	1.85	2.32	2.32	1.46	1.16	1.96	2.29	1.46
18.0	1.71	2.19	2.20	1.34	1.04	1.80	2.13	1.34

- 1B = One mid span brace
- 2B = Two equally spaced braces within the span
- 3B = Three equally spaced braces within the span
- w_s = Uniformly distributed serviceability load (kN/m) for deflection limit of Span/150
- $\phi_b w_u$ = Strength load resistance applied at the centroid (kN/m)

- 2-M12 Grade 4.6 bolts per connection
- 2-M12 Grade 8.8 bolts per connection
- 2-M16 Grade 4.6 bolts per connection
- 2-M16 Grade 8.8 bolts per connection

IMPORTANT

The adequacy of multispan system is very sensitive to actual applied loads. The stated loads in this table are assumed uniform over the full purlin system. Variations in actual project design loadings over the length of the purlin system must be checked specifically by the designer to verify system adequacy.

THREE SPAN LAPPED

LOAD TABLE – Uniformly Distributed Load

MSS 400/30								
SPAN (m)	INWARDS				OUTWARDS			
	$\phi_b w_u$ kN/m			w_s kN/m	$\phi_b w_u$ kN/m			w_s kN/m
	1B	2B	3B		1B	2B	3B	
3.0								
3.5								
4.0								
4.5								
5.0								
5.5								
6.0	17.9	17.9	17.9	44.08	17.9	17.9	17.9	44.08
6.5	16.5	16.5	16.5	34.67	16.5	16.5	16.5	34.67
7.0	15.3	15.3	15.3	27.76	15.3	15.3	15.3	27.76
7.5	14.3	14.3	14.3	22.57	14.3	14.3	14.3	22.57
8.0	13.4	13.4	13.4	18.60	13.4	13.4	13.4	18.60
8.5	12.6	12.6	12.6	15.50	12.6	12.6	12.6	15.50
9.0	11.6	11.6	11.6	13.06	11.6	11.6	11.6	13.06
9.5	10.4	10.4	10.4	11.11	10.4	10.4	10.4	11.11
10.0	9.34	9.42	9.42	9.52	9.42	9.42	9.42	9.52
10.5	8.25	8.55	8.55	8.23	8.51	8.55	8.55	8.23
11.0	7.33	7.79	7.79	7.15	7.46	7.79	7.79	7.15
11.5	6.53	7.12	7.12	6.26	6.55	7.12	7.12	6.26
12.0	5.84	6.54	6.54	5.51	5.75	6.54	6.54	5.51
12.5	5.24	6.03	6.03	4.88	5.04	6.03	6.03	4.88
13.0	4.72	5.58	5.58	4.33	4.42	5.58	5.58	4.33
13.5	4.26	5.17	5.17	3.87	3.86	5.17	5.17	3.87
14.0	3.86	4.81	4.81	3.47	3.37	4.81	4.81	3.47
14.5	3.51	4.48	4.48	3.12	2.94	4.48	4.48	3.12
15.0	3.19	4.19	4.19	2.82	2.57	4.01	4.19	2.82
15.5	2.91	3.92	3.92	2.56	2.26	3.65	3.92	2.56
16.0	2.66	3.68	3.68	2.32	2.00	3.31	3.68	2.32
16.5	2.44	3.46	3.46	2.12	1.78	3.01	3.46	2.12
17.0	2.24	3.26	3.26	1.94	1.58	2.73	3.26	1.94
17.5	2.06	3.08	3.08	1.78	1.41	2.48	3.08	1.78
18.0	1.90	2.88	2.91	1.63	1.27	2.24	2.86	1.63

- 1B = One mid span brace
 2B = Two equally spaced braces within the span
 3B = Three equally spaced braces within the span
 w_s = Uniformly distributed serviceability load (kN/m)
 for deflection limit of Span/150
 $\phi_b w_u$ = Strength load resistance applied at the
 centroid (kN/m)

- 2-M12 Grade 4.6 bolts per connection
- 2-M12 Grade 8.8 bolts per connection
- 2-M16 Grade 4.6 bolts per connection
- 2-M16 Grade 8.8 bolts per connection

IMPORTANT

The adequacy of multispan system is very sensitive to actual applied loads. The stated loads in this table are assumed uniform over the full purlin system. Variations in actual project design loadings over the length of the purlin system must be checked specifically by the designer to verify system adequacy.

LAPPED MULTISPAN (END SPAN)

LOAD TABLE – Uniformly Distributed Load

MSS 150/12								
SPAN (m)	INWARDS			Ws kN/m	OUTWARDS			Ws kN/m
	$\phi_b w_u$ kN/m				$\phi_b w_u$ kN/m			
	1B	2B	3B		1B	2B	3B	
3.0	8.38	8.38	8.38	Generally not limiting design - verify by calculation	8.38	8.38	8.38	Generally not limiting design - verify by calculation
3.5	5.71	5.71	5.71		5.71	5.71	5.71	
4.0	4.17	4.17	4.17		4.17	4.17	4.17	
4.5	3.15	3.15	3.15		3.15	3.15	3.15	
5.0	2.49	2.49	2.49		2.49	2.49	2.49	
5.5	2.02	2.02	2.02		2.02	2.02	2.02	
6.0	1.66	1.66	1.66		1.66	1.66	1.66	
6.5	1.41	1.41	1.41		1.41	1.41	1.41	
7.0	1.22	1.22	1.22		1.22	1.22	1.22	
7.5	1.06	1.06	1.06		1.04	1.06	1.06	
8.0	0.93	0.93	0.93		0.89	0.93	0.93	
8.5	0.83	0.83	0.83		0.77	0.83	0.83	
9.0	0.74	0.74	0.74		0.65	0.74	0.74	
9.5	0.66	0.66	0.66		0.54	0.66	0.66	
10.0	0.60	0.60	0.60		0.44	0.59	0.60	
10.5	0.54	0.54	0.54		0.37	0.52	0.54	
11.0	0.48	0.49	0.49		0.31	0.47	0.49	
11.5								
12.0								
12.5								
13.0								
13.5								
14.0								
14.5								
15.0								
15.5								
16.0								
16.5								
17.0								
17.5								
18.0								

MSS 150/15								
SPAN (m)	INWARDS			Ws kN/m	OUTWARDS			Ws kN/m
	$\phi_b w_u$ kN/m				$\phi_b w_u$ kN/m			
	1B	2B	3B		1B	2B	3B	
3.0	11.5	11.5	11.5	Generally not limiting design - verify by calculation	11.5	11.5	11.5	Generally not limiting design - verify by calculation
3.5	7.81	7.81	7.81		7.81	7.81	7.81	
4.0	5.70	5.70	5.70		5.70	5.70	5.70	
4.5	4.30	4.30	4.30		4.30	4.30	4.30	
5.0	3.41	3.41	3.41		3.41	3.41	3.41	
5.5	2.76	2.76	2.76		2.76	2.76	2.76	
6.0	2.27	2.27	2.27		2.27	2.27	2.27	
6.5	1.93	1.93	1.93		1.93	1.93	1.93	
7.0	1.67	1.67	1.67		1.67	1.67	1.67	
7.5	1.45	1.45	1.45		1.43	1.45	1.45	
8.0	1.28	1.28	1.28		1.22	1.28	1.28	
8.5	1.13	1.13	1.13		1.04	1.13	1.13	
9.0	1.01	1.01	1.01		0.87	1.01	1.01	
9.5	0.90	0.90	0.90		0.71	0.90	0.90	
10.0	0.81	0.82	0.82		0.59	0.81	0.82	
10.5	0.72	0.74	0.74		0.49	0.71	0.74	
11.0	0.65	0.67	0.67		0.41	0.63	0.67	
11.5								
12.0								
12.5								
13.0								
13.5								
14.0								
14.5								
15.0								
15.5								
16.0								
16.5								
17.0								
17.5								
18.0								

- 1B = One mid span brace
- 2B = Two equally spaced braces within the span
- 3B = Three equally spaced braces within the span
- w_s = Uniformly distributed serviceability load (kN/m) for deflection limit of Span/150
- $\phi_b w_u$ = Strength load resistance applied at the centroid (kN/m)

- 2-M12 Grade 4.6 bolts per connection
- 2-M12 Grade 8.8 bolts per connection
- 2-M16 Grade 4.6 bolts per connection
- 2-M16 Grade 8.8 bolts per connection

IMPORTANT

The adequacy of multispans system is very sensitive to actual applied loads. The stated loads in this table are assumed uniform over the full purlin system. Variations in actual project design loadings over the length of the purlin system must be checked specifically by the designer to verify system adequacy.

LAPPED MULTISPAN (END SPAN)

LOAD TABLE – Uniformly Distributed Load

MSS 150/18								
SPAN (m)	INWARDS			Ws kN/m	OUTWARDS			Ws kN/m
	$\phi_b w_u$ kN/m				$\phi_b w_u$ kN/m			
	1B	2B	3B		1B	2B	3B	
3.0	13.7	13.7	13.7	Generally not limiting design - verify by calculation	13.7	13.7	13.7	Generally not limiting design - verify by calculation
3.5	9.33	9.33	9.33		9.33	9.33	9.33	
4.0	6.81	6.81	6.81		6.81	6.81	6.81	
4.5	5.14	5.14	5.14		5.14	5.14	5.14	
5.0	4.07	4.07	4.07		4.07	4.07	4.07	
5.5	3.29	3.29	3.29		3.29	3.29	3.29	
6.0	2.71	2.71	2.71		2.71	2.71	2.71	
6.5	2.31	2.31	2.31		2.31	2.31	2.31	
7.0	1.99	1.99	1.99		1.99	1.99	1.99	
7.5	1.73	1.73	1.73		1.68	1.73	1.73	
8.0	1.52	1.52	1.52		1.44	1.52	1.52	
8.5	1.35	1.35	1.35		1.23	1.35	1.35	
9.0	1.19	1.20	1.20		1.05	1.20	1.20	
9.5	1.05	1.08	1.08		0.86	1.08	1.08	
10.0	0.94	0.98	0.98		0.71	0.95	0.98	
10.5	0.84	0.88	0.88		0.59	0.84	0.88	
11.0	0.75	0.81	0.81		0.50	0.75	0.81	
11.5								
12.0								
12.5								
13.0								
13.5								
14.0								
14.5								
15.0								
15.5								
16.0								
16.5								
17.0								
17.5								
18.0								

MSS 150/23								
SPAN (m)	INWARDS			Ws kN/m	OUTWARDS			Ws kN/m
	$\phi_b w_u$ kN/m				$\phi_b w_u$ kN/m			
	1B	2B	3B		1B	2B	3B	
3.0	18.9	18.9	18.9	Generally not limiting design - verify by calculation	18.9	18.9	18.9	Generally not limiting design - verify by calculation
3.5	12.8	12.8	12.8		12.8	12.8	12.8	
4.0	9.38	9.38	9.38		9.38	9.38	9.38	
4.5	7.08	7.08	7.08		7.08	7.08	7.08	
5.0	5.61	5.61	5.61		5.61	5.61	5.61	
5.5	4.52	4.54	4.54		4.54	4.54	4.54	
6.0	3.67	3.73	3.73		3.68	3.73	3.73	
6.5	3.08	3.18	3.18		3.05	3.18	3.18	
7.0	2.62	2.74	2.74		2.56	2.74	2.74	
7.5	2.25	2.39	2.39		2.16	2.39	2.39	
8.0	1.95	2.10	2.10		1.84	2.08	2.10	
8.5	1.70	1.86	1.86		1.57	1.81	1.86	
9.0	1.50	1.66	1.66		1.35	1.58	1.66	
9.5	1.33	1.49	1.49		1.12	1.39	1.49	
10.0	1.18	1.34	1.34		0.92	1.22	1.33	
10.5	1.05	1.20	1.22		0.77	1.08	1.19	
11.0	0.94	1.08	1.11		0.65	0.96	1.06	
11.5								
12.0								
12.5								
13.0								
13.5								
14.0								
14.5								
15.0								
15.5								
16.0								
16.5								
17.0								
17.5								
18.0								

- 1B = One mid span brace
- 2B = Two equally spaced braces within the span
- 3B = Three equally spaced braces within the span
- w_s = Uniformly distributed serviceability load (kN/m) for deflection limit of Span/150
- $\phi_b w_u$ = Strength load resistance applied at the centroid (kN/m)

- 2-M12 Grade 4.6 bolts per connection
- 2-M12 Grade 8.8 bolts per connection
- 2-M16 Grade 4.6 bolts per connection
- 2-M16 Grade 8.8 bolts per connection

IMPORTANT

The adequacy of multispans system is very sensitive to actual applied loads. The stated loads in this table are assumed uniform over the full purlin system. Variations in actual project design loadings over the length of the purlin system must be checked specifically by the designer to verify system adequacy.

LAPPED MULTISPAN (END SPAN)

LOAD TABLE – Uniformly Distributed Load

MSS 200/12								
SPAN (m)	INWARDS			Ws kN/m	OUTWARDS			Ws kN/m
	$\phi_b w_u$ kN/m				$\phi_b w_u$ kN/m			
	1B	2B	3B		1B	2B	3B	
3.0	9.67	9.67	9.67	Generally not limiting design - verify by calculation	9.67	9.67	9.67	Generally not limiting design - verify by calculation
3.5	7.20	7.20	7.20		7.20	7.20	7.20	
4.0	5.56	5.56	5.56		5.56	5.56	5.56	
4.5	4.38	4.38	4.38		4.38	4.38	4.38	
5.0	3.54	3.54	3.54		3.54	3.54	3.54	
5.5	2.86	2.86	2.86		2.86	2.86	2.86	
6.0	2.35	2.35	2.35		2.35	2.35	2.35	
6.5	2.01	2.01	2.01		2.01	2.01	2.01	
7.0	1.73	1.73	1.73		1.73	1.73	1.73	
7.5	1.51	1.51	1.51		1.50	1.51	1.51	
8.0	1.32	1.32	1.32		1.29	1.32	1.32	
8.5	1.17	1.17	1.17		1.12	1.17	1.17	
9.0	1.05	1.05	1.05		0.97	1.05	1.05	
9.5	0.93	0.94	0.94		0.85	0.94	0.94	
10.0	0.83	0.85	0.85		0.74	0.84	0.85	
10.5	0.75	0.77	0.77		0.65	0.75	0.77	
11.0	0.68	0.70	0.70		0.56	0.67	0.70	
11.5	0.61	0.64	0.64		0.48	0.61	0.64	
12.0	0.56	0.59	0.59	0.41	0.55	0.59		
12.5	0.51	0.54	0.54	0.35	0.49	0.54		
13.0	0.46	0.50	0.50	0.31	0.45	0.49		
13.5	0.42	0.46	0.47	0.27	0.40	0.45		
14.0	0.39	0.43	0.43	0.23	0.36	0.41		
14.5	0.36	0.39	0.40	0.20	0.33	0.38		
15.0	0.33	0.36	0.38	0.18	0.30	0.35		
15.5								
16.0								
16.5								
17.0								
17.5								
18.0								

MSS 200/15								
SPAN (m)	INWARDS			Ws kN/m	OUTWARDS			Ws kN/m
	$\phi_b w_u$ kN/m				$\phi_b w_u$ kN/m			
	1B	2B	3B		1B	2B	3B	
3.0	15.1	15.1	15.1	Generally not limiting design - verify by calculation	15.1	15.1	15.1	Generally not limiting design - verify by calculation
3.5	11.1	11.1	11.1		11.1	11.1	11.1	
4.0	8.16	8.16	8.16		8.16	8.16	8.16	
4.5	6.16	6.16	6.16		6.16	6.16	6.16	
5.0	4.88	4.88	4.88		4.88	4.88	4.88	
5.5	3.95	3.95	3.95		3.95	3.95	3.95	
6.0	3.25	3.25	3.25		3.25	3.25	3.25	
6.5	2.77	2.77	2.77		2.77	2.77	2.77	
7.0	2.38	2.38	2.38		2.38	2.38	2.38	
7.5	2.08	2.08	2.08		2.08	2.08	2.08	
8.0	1.83	1.83	1.83		1.83	1.83	1.83	
8.5	1.62	1.62	1.62		1.62	1.62	1.62	
9.0	1.44	1.44	1.44		1.43	1.44	1.44	
9.5	1.30	1.30	1.30		1.25	1.30	1.30	
10.0	1.17	1.17	1.17		1.07	1.17	1.17	
10.5	1.06	1.06	1.06		0.89	1.06	1.06	
11.0	0.97	0.97	0.97		0.75	0.97	0.97	
11.5	0.88	0.88	0.88		0.64	0.88	0.88	
12.0	0.80	0.81	0.81	0.54	0.80	0.81		
12.5	0.73	0.75	0.75	0.47	0.73	0.75		
13.0	0.67	0.69	0.69	0.40	0.66	0.69		
13.5	0.61	0.64	0.64	0.35	0.58	0.64		
14.0	0.56	0.60	0.60	0.30	0.51	0.60		
14.5	0.52	0.56	0.56	0.27	0.45	0.56		
15.0	0.48	0.52	0.52	0.23	0.40	0.51		
15.5								
16.0								
16.5								
17.0								
17.5								
18.0								

- 1B = One mid span brace
- 2B = Two equally spaced braces within the span
- 3B = Three equally spaced braces within the span
- w_s = Uniformly distributed serviceability load (kN/m) for deflection limit of Span/150
- $\phi_b w_u$ = Strength load resistance applied at the centroid (kN/m)

- 2-M12 Grade 4.6 bolts per connection
- 2-M12 Grade 8.8 bolts per connection
- 2-M16 Grade 4.6 bolts per connection
- 2-M16 Grade 8.8 bolts per connection

IMPORTANT

The adequacy of multispan system is very sensitive to actual applied loads. The stated loads in this table are assumed uniform over the full purlin system. Variations in actual project design loadings over the length of the purlin system must be checked specifically by the designer to verify system adequacy.

LAPPED MULTISPAN (END SPAN)

LOAD TABLE – Uniformly Distributed Load

MSS 200/18								
SPAN (m)	INWARDS			Ws kN/m	OUTWARDS			Ws kN/m
	$\phi_b w_u$ kN/m				$\phi_b w_u$ kN/m			
	1B	2B	3B		1B	2B	3B	
3.0	19.8	19.8	19.8	Generally not limiting design - verify by calculation	19.8	19.8	19.8	Generally not limiting design - verify by calculation
3.5	13.5	13.5	13.5		13.5	13.5	13.5	
4.0	9.85	9.85	9.85		9.85	9.85	9.85	
4.5	7.43	7.43	7.43		7.43	7.43	7.43	
5.0	5.89	5.89	5.89		5.89	5.89	5.89	
5.5	4.76	4.76	4.76		4.76	4.76	4.76	
6.0	3.92	3.92	3.92		3.92	3.92	3.92	
6.5	3.34	3.34	3.34		3.34	3.34	3.34	
7.0	2.88	2.88	2.88		2.88	2.88	2.88	
7.5	2.51	2.51	2.51		2.51	2.51	2.51	
8.0	2.20	2.20	2.20		2.20	2.20	2.20	
8.5	1.95	1.95	1.95		1.95	1.95	1.95	
9.0	1.74	1.74	1.74		1.74	1.74	1.74	
9.5	1.56	1.56	1.56		1.51	1.56	1.56	
10.0	1.41	1.41	1.41		1.32	1.41	1.41	
10.5	1.28	1.28	1.28		1.11	1.28	1.28	
11.0	1.17	1.17	1.17		0.93	1.17	1.17	
11.5	1.06	1.07	1.07		0.78	1.07	1.07	
12.0	0.96	0.98	0.98	0.66	0.98	0.98		
12.5	0.87	0.90	0.90	0.57	0.88	0.90		
13.0	0.79	0.83	0.83	0.49	0.80	0.83		
13.5	0.73	0.77	0.77	0.42	0.72	0.77		
14.0	0.66	0.72	0.72	0.37	0.64	0.72		
14.5	0.61	0.67	0.67	0.32	0.56	0.67		
15.0	0.56	0.63	0.63	0.28	0.49	0.63		
15.5								
16.0								
16.5								
17.0								
17.5								
18.0								

MSS 200/23								
SPAN (m)	INWARDS			Ws kN/m	OUTWARDS			Ws kN/m
	$\phi_b w_u$ kN/m				$\phi_b w_u$ kN/m			
	1B	2B	3B		1B	2B	3B	
3.0	27.1	27.1	27.0	Generally not limiting design - verify by calculation	27.1	27.1	27.0	Generally not limiting design - verify by calculation
3.5	18.8	18.8	18.8		18.8	18.8	18.8	
4.0	13.8	13.8	13.8		13.8	13.8	13.8	
4.5	10.4	10.4	10.4		10.4	10.4	10.4	
5.0	8.22	8.22	8.22		8.22	8.22	8.22	
5.5	6.65	6.65	6.65		6.65	6.65	6.65	
6.0	5.47	5.47	5.47		5.47	5.47	5.47	
6.5	4.66	4.66	4.66		4.66	4.66	4.66	
7.0	4.02	4.02	4.02		4.02	4.02	4.02	
7.5	3.48	3.50	3.50		3.48	3.50	3.50	
8.0	3.03	3.08	3.08		3.02	3.08	3.08	
8.5	2.66	2.73	2.73		2.62	2.73	2.73	
9.0	2.35	2.43	2.43		2.29	2.43	2.43	
9.5	2.09	2.18	2.18		2.00	2.18	2.18	
10.0	1.87	1.97	1.97		1.71	1.97	1.97	
10.5	1.68	1.79	1.79		1.42	1.76	1.79	
11.0	1.51	1.63	1.63		1.19	1.59	1.63	
11.5	1.36	1.49	1.49		1.01	1.43	1.49	
12.0	1.23	1.37	1.37	0.86	1.29	1.37		
12.5	1.12	1.26	1.26	0.73	1.17	1.26		
13.0	1.02	1.16	1.17	0.63	1.05	1.15		
13.5	0.92	1.07	1.08	0.55	0.94	1.06		
14.0	0.84	0.99	1.01	0.48	0.82	0.97		
14.5	0.77	0.91	0.94	0.42	0.72	0.89		
15.0	0.71	0.84	0.88	0.37	0.63	0.82		
15.5								
16.0								
16.5								
17.0								
17.5								
18.0								

- 1B = One mid span brace
- 2B = Two equally spaced braces within the span
- 3B = Three equally spaced braces within the span
- w_s = Uniformly distributed serviceability load (kN/m) for deflection limit of Span/150
- $\phi_b w_u$ = Strength load resistance applied at the centroid (kN/m)

- 2-M12 Grade 4.6 bolts per connection
- 2-M12 Grade 8.8 bolts per connection
- 2-M16 Grade 4.6 bolts per connection
- 2-M16 Grade 8.8 bolts per connection

IMPORTANT

The adequacy of multispans system is very sensitive to actual applied loads. The stated loads in this table are assumed uniform over the full purlin system. Variations in actual project design loadings over the length of the purlin system must be checked specifically by the designer to verify system adequacy.

LAPPED MULTISPAN (END SPAN)

LOAD TABLE – Uniformly Distributed Load

MSS 250/13								
SPAN (m)	INWARDS			Ws kN/m	OUTWARDS			Ws kN/m
	$\phi_b w_u$ kN/m				$\phi_b w_u$ kN/m			
	1B	2B	3B		1B	2B	3B	
3.0								
3.5								
4.0	7.70	7.70	7.69		7.70	7.70	7.69	
4.5	6.14	6.14	6.14		6.14	6.14	6.14	
5.0	5.05	5.05	5.05		5.05	5.05	5.05	
5.5	4.20	4.20	4.20		4.20	4.20	4.20	
6.0	3.54	3.54	3.54		3.54	3.54	3.54	
6.5	3.06	3.06	3.06		3.06	3.06	3.06	
7.0	2.68	2.68	2.68		2.68	2.68	2.68	
7.5	2.33	2.36	2.36		2.32	2.36	2.36	
8.0	2.03	2.07	2.07		2.01	2.07	2.07	
8.5	1.78	1.84	1.84		1.75	1.84	1.84	
9.0	1.57	1.64	1.64		1.53	1.64	1.64	
9.5	1.40	1.47	1.47		1.35	1.47	1.47	
10.0	1.25	1.33	1.33		1.19	1.31	1.33	
10.5	1.13	1.20	1.20		1.06	1.18	1.20	
11.0	1.02	1.10	1.10		0.94	1.06	1.10	
11.5	0.92	1.00	1.00		0.83	0.95	1.00	
12.0	0.84	0.92	0.92		0.74	0.86	0.92	
12.5	0.77	0.84	0.85		0.66	0.78	0.84	
13.0	0.70	0.77	0.79		0.58	0.71	0.77	
13.5	0.64	0.71	0.73		0.51	0.65	0.70	
14.0	0.59	0.66	0.68		0.46	0.59	0.65	
14.5	0.55	0.61	0.63		0.41	0.54	0.60	
15.0	0.50	0.56	0.59		0.36	0.50	0.55	
15.5	0.47	0.52	0.55		0.32	0.46	0.51	
16.0	0.43	0.49	0.51		0.29	0.42	0.47	
16.5	0.40	0.45	0.48		0.25	0.38	0.44	
17.0	0.37	0.42	0.45		0.23	0.35	0.41	
17.5								
18.0								

Generally not limiting design - verify by calculation

Generally not limiting design - verify by calculation

MSS 250/15								
SPAN (m)	INWARDS			Ws kN/m	OUTWARDS			Ws kN/m
	$\phi_b w_u$ kN/m				$\phi_b w_u$ kN/m			
	1B	2B	3B		1B	2B	3B	
3.0								
3.5								
4.0	10.2	10.2	10.2		10.2	10.2	10.2	
4.5	8.03	8.03	8.03		8.03	8.03	8.03	
5.0	6.57	6.57	6.57		6.57	6.57	6.57	
5.5	5.45	5.45	5.45		5.45	5.45	5.45	
6.0	4.53	4.53	4.53		4.53	4.53	4.53	
6.5	3.86	3.86	3.86		3.86	3.86	3.86	
7.0	3.33	3.33	3.33		3.33	3.33	3.33	
7.5	2.90	2.90	2.90		2.90	2.90	2.90	
8.0	2.54	2.55	2.55		2.53	2.55	2.55	
8.5	2.23	2.26	2.26		2.21	2.26	2.26	
9.0	1.97	2.01	2.01		1.93	2.01	2.01	
9.5	1.75	1.81	1.81		1.70	1.81	1.81	
10.0	1.56	1.63	1.63		1.50	1.63	1.63	
10.5	1.41	1.48	1.48		1.33	1.48	1.48	
11.0	1.27	1.35	1.35		1.18	1.33	1.35	
11.5	1.15	1.23	1.23		1.06	1.21	1.23	
12.0	1.05	1.13	1.13		0.94	1.09	1.13	
12.5	0.95	1.04	1.04		0.84	0.99	1.04	
13.0	0.87	0.97	0.97		0.73	0.90	0.97	
13.5	0.80	0.89	0.90		0.64	0.82	0.89	
14.0	0.74	0.82	0.83		0.56	0.75	0.82	
14.5	0.68	0.76	0.78		0.49	0.69	0.75	
15.0	0.63	0.71	0.73		0.43	0.63	0.70	
15.5	0.58	0.66	0.68		0.38	0.58	0.64	
16.0	0.54	0.61	0.64		0.34	0.53	0.60	
16.5	0.50	0.57	0.60		0.30	0.49	0.55	
17.0	0.46	0.53	0.56		0.27	0.45	0.52	
17.5								
18.0								

Generally not limiting design - verify by calculation

Generally not limiting design - verify by calculation

- 1B = One mid span brace
- 2B = Two equally spaced braces within the span
- 3B = Three equally spaced braces within the span
- w_s = Uniformly distributed serviceability load (kN/m) for deflection limit of Span/150
- $\phi_b w_u$ = Strength load resistance applied at the centroid (kN/m)

- 2-M12 Grade 4.6 bolts per connection
- 2-M12 Grade 8.8 bolts per connection
- 2-M16 Grade 4.6 bolts per connection
- 2-M16 Grade 8.8 bolts per connection

IMPORTANT

The adequacy of multispan system is very sensitive to actual applied loads. The stated loads in this table are assumed uniform over the full purlin system. Variations in actual project design loadings over the length of the purlin system must be checked specifically by the designer to verify system adequacy.

LAPPED MULTISPAN (END SPAN)

LOAD TABLE – Uniformly Distributed Load

MSS 250/18								
SPAN (m)	INWARDS			Ws kN/m	OUTWARDS			Ws kN/m
	$\phi_b w_u$ kN/m				$\phi_b w_u$ kN/m			
	1B	2B	3B		1B	2B	3B	
3.0								
3.5								
4.0	13.7	13.7	13.7		13.7	13.7	13.7	
4.5	10.4	10.4	10.4		10.4	10.4	10.4	
5.0	8.27	8.27	8.27		8.27	8.27	8.27	
5.5	6.69	6.69	6.69		6.69	6.69	6.69	
6.0	5.50	5.50	5.50		5.50	5.50	5.50	
6.5	4.69	4.69	4.69		4.69	4.69	4.69	
7.0	4.04	4.04	4.04		4.04	4.04	4.04	
7.5	3.52	3.52	3.52		3.52	3.52	3.52	
8.0	3.09	3.09	3.09		3.09	3.09	3.09	
8.5	2.74	2.74	2.74		2.74	2.74	2.74	
9.0	2.45	2.45	2.45		2.45	2.45	2.45	
9.5	2.19	2.19	2.19		2.19	2.19	2.19	
10.0	1.98	1.98	1.98		1.98	1.98	1.98	
10.5	1.80	1.80	1.80		1.74	1.80	1.80	
11.0	1.62	1.64	1.64		1.55	1.64	1.64	
11.5	1.47	1.50	1.50		1.39	1.50	1.50	
12.0	1.34	1.38	1.38		1.23	1.38	1.38	
12.5	1.22	1.27	1.27		1.06	1.27	1.27	
13.0	1.12	1.17	1.17		0.92	1.17	1.17	
13.5	1.03	1.09	1.09		0.80	1.07	1.09	
14.0	0.95	1.01	1.01		0.70	0.98	1.01	
14.5	0.88	0.94	0.94		0.61	0.90	0.94	
15.0	0.81	0.88	0.88		0.54	0.83	0.88	
15.5	0.75	0.82	0.82		0.47	0.76	0.82	
16.0	0.70	0.77	0.77		0.42	0.70	0.77	
16.5	0.65	0.73	0.73		0.37	0.63	0.72	
17.0	0.60	0.69	0.69		0.33	0.57	0.67	
17.5								
18.0								

Generally not limiting design - verify by calculation

Generally not limiting design - verify by calculation

MSS 250/23								
SPAN (m)	INWARDS			Ws kN/m	OUTWARDS			Ws kN/m
	$\phi_b w_u$ kN/m				$\phi_b w_u$ kN/m			
	1B	2B	3B		1B	2B	3B	
3.0								
3.5								
4.0	19.4	19.4	19.4		19.4	19.4	19.4	
4.5	14.6	14.6	14.6		14.6	14.6	14.6	
5.0	11.6	11.6	11.6		11.6	11.6	11.6	
5.5	9.37	9.37	9.37		9.37	9.37	9.37	
6.0	7.71	7.71	7.71		7.71	7.71	7.71	
6.5	6.57	6.57	6.57		6.57	6.57	6.57	
7.0	5.67	5.67	5.67		5.67	5.67	5.67	
7.5	4.94	4.94	4.94		4.94	4.94	4.94	
8.0	4.34	4.34	4.34		4.34	4.34	4.34	
8.5	3.84	3.84	3.84		3.84	3.84	3.84	
9.0	3.43	3.43	3.43		3.43	3.43	3.43	
9.5	3.08	3.08	3.08		3.08	3.08	3.08	
10.0	2.78	2.78	2.78		2.77	2.78	2.78	
10.5	2.50	2.52	2.52		2.45	2.52	2.52	
11.0	2.25	2.29	2.29		2.17	2.29	2.29	
11.5	2.03	2.10	2.10		1.90	2.10	2.10	
12.0	1.84	1.93	1.93		1.63	1.93	1.93	
12.5	1.67	1.78	1.78		1.39	1.78	1.78	
13.0	1.52	1.64	1.64		1.19	1.64	1.64	
13.5	1.39	1.52	1.52		1.03	1.52	1.52	
14.0	1.27	1.42	1.42		0.90	1.39	1.42	
14.5	1.17	1.32	1.32		0.78	1.27	1.32	
15.0	1.07	1.23	1.23		0.69	1.16	1.23	
15.5	0.99	1.16	1.16		0.61	1.06	1.16	
16.0	0.91	1.08	1.08		0.54	0.94	1.08	
16.5	0.84	1.02	1.02		0.48	0.84	1.02	
17.0	0.78	0.96	0.96		0.43	0.74	0.95	
17.5								
18.0								

Generally not limiting design - verify by calculation

Generally not limiting design - verify by calculation

- 1B = One mid span brace
- 2B = Two equally spaced braces within the span
- 3B = Three equally spaced braces within the span
- w_s = Uniformly distributed serviceability load (kN/m) for deflection limit of Span/150
- $\phi_b w_u$ = Strength load resistance applied at the centroid (kN/m)

- 2-M12 Grade 4.6 bolts per connection
- 2-M12 Grade 8.8 bolts per connection
- 2-M16 Grade 4.6 bolts per connection
- 2-M16 Grade 8.8 bolts per connection

IMPORTANT

The adequacy of multispan system is very sensitive to actual applied loads. The stated loads in this table are assumed uniform over the full purlin system. Variations in actual project design loadings over the length of the purlin system must be checked specifically by the designer to verify system adequacy.

LAPPED MULTISPAN (END SPAN)

LOAD TABLE – Uniformly Distributed Load

MSS 275/15								
SPAN (m)	INWARDS			Ws kN/m	OUTWARDS			Ws kN/m
	$\phi_b w_u$ kN/m				$\phi_b w_u$ kN/m			
	1B	2B	3B		1B	2B	3B	
3.0								
3.5								
4.0								
4.5	7.99	7.99	7.99		7.99	7.99	7.99	
5.0	6.64	6.64	6.64		6.64	6.64	6.64	
5.5	5.58	5.58	5.58		5.58	5.58	5.58	
6.0	4.74	4.74	4.74		4.74	4.74	4.74	
6.5	4.13	4.13	4.13		4.13	4.13	4.13	
7.0	3.62	3.62	3.62		3.62	3.62	3.62	
7.5	3.20	3.20	3.20		3.20	3.20	3.20	
8.0	2.83	2.85	2.85		2.85	2.85	2.85	
8.5	2.49	2.53	2.53		2.49	2.53	2.53	
9.0	2.20	2.25	2.25		2.18	2.25	2.25	
9.5	1.95	2.02	2.02		1.92	2.02	2.02	
10.0	1.75	1.83	1.83		1.70	1.83	1.83	
10.5	1.57	1.66	1.66		1.51	1.66	1.66	
11.0	1.42	1.51	1.51		1.35	1.50	1.51	
11.5	1.28	1.38	1.38		1.20	1.36	1.38	
12.0	1.17	1.27	1.27		1.08	1.23	1.27	
12.5	1.07	1.17	1.17		0.96	1.12	1.17	
13.0	0.97	1.08	1.08		0.86	1.02	1.08	
13.5	0.89	1.00	1.00		0.76	0.93	1.00	
14.0	0.82	0.92	0.93		0.67	0.85	0.92	
14.5	0.76	0.86	0.87		0.60	0.78	0.85	
15.0	0.70	0.79	0.81		0.53	0.72	0.79	
15.5	0.65	0.74	0.76		0.47	0.66	0.73	
16.0	0.60	0.69	0.71		0.42	0.61	0.68	
16.5	0.56	0.64	0.67		0.37	0.56	0.63	
17.0	0.52	0.60	0.63		0.34	0.51	0.58	
17.5								
18.0								

Generally not limiting design - verify by calculation

Generally not limiting design - verify by calculation

MSS 275/18								
SPAN (m)	INWARDS			Ws kN/m	OUTWARDS			Ws kN/m
	$\phi_b w_u$ kN/m				$\phi_b w_u$ kN/m			
	1B	2B	3B		1B	2B	3B	
3.0								
3.5								
4.0								
4.5	11.0	11.0	11.0		11.0	11.0	11.0	
5.0	9.02	9.02	9.02		9.02	9.02	9.02	
5.5	7.50	7.50	7.50		7.50	7.50	7.50	
6.0	6.17	6.17	6.17		6.17	6.17	6.17	
6.5	5.26	5.26	5.26		5.26	5.26	5.26	
7.0	4.53	4.53	4.53		4.53	4.53	4.53	
7.5	3.95	3.95	3.95		3.95	3.95	3.95	
8.0	3.47	3.47	3.47		3.47	3.47	3.47	
8.5	3.07	3.07	3.07		3.07	3.07	3.07	
9.0	2.74	2.74	2.74		2.74	2.74	2.74	
9.5	2.46	2.46	2.46		2.46	2.46	2.46	
10.0	2.22	2.22	2.22		2.20	2.22	2.22	
10.5	2.00	2.01	2.01		1.96	2.01	2.01	
11.0	1.81	1.84	1.84		1.76	1.84	1.84	
11.5	1.64	1.68	1.68		1.57	1.68	1.68	
12.0	1.49	1.54	1.54		1.41	1.54	1.54	
12.5	1.36	1.42	1.42		1.27	1.42	1.42	
13.0	1.25	1.31	1.31		1.13	1.31	1.31	
13.5	1.15	1.22	1.22		0.98	1.21	1.22	
14.0	1.06	1.13	1.13		0.86	1.11	1.13	
14.5	0.97	1.06	1.06		0.76	1.02	1.06	
15.0	0.90	0.99	0.99		0.67	0.94	0.99	
15.5	0.84	0.92	0.92		0.59	0.86	0.92	
16.0	0.78	0.87	0.87		0.52	0.80	0.87	
16.5	0.72	0.82	0.82		0.46	0.74	0.81	
17.0	0.67	0.77	0.77		0.41	0.68	0.76	
17.5								
18.0								

Generally not limiting design - verify by calculation

Generally not limiting design - verify by calculation

- 1B = One mid span brace
- 2B = Two equally spaced braces within the span
- 3B = Three equally spaced braces within the span
- w_s = Uniformly distributed serviceability load (kN/m) for deflection limit of Span/150
- $\phi_b w_u$ = Strength load resistance applied at the centroid (kN/m)

- 2-M12 Grade 4.6 bolts per connection
- 2-M12 Grade 8.8 bolts per connection
- 2-M16 Grade 4.6 bolts per connection
- 2-M16 Grade 8.8 bolts per connection

IMPORTANT

The adequacy of multispan system is very sensitive to actual applied loads. The stated loads in this table are assumed uniform over the full purlin system. Variations in actual project design loadings over the length of the purlin system must be checked specifically by the designer to verify system adequacy.

LAPPED MULTISPAN (END SPAN)

LOAD TABLE – Uniformly Distributed Load

MSS 300/15								
SPAN (m)	INWARDS			Ws kN/m	OUTWARDS			Ws kN/m
	$\phi_b w_u$ kN/m				$\phi_b w_u$ kN/m			
	1B	2B	3B		1B	2B	3B	
3.0								
3.5								
4.0								
4.5								
5.0	6.80	6.80	6.80		6.80	6.80	6.80	
5.5	5.79	5.79	5.79		5.79	5.79	5.79	
6.0	4.96	4.96	4.96		4.96	4.96	4.96	
6.5	4.36	4.36	4.36		4.36	4.36	4.36	
7.0	3.85	3.85	3.85		3.85	3.85	3.85	
7.5	3.43	3.43	3.43		3.43	3.43	3.43	
8.0	3.07	3.07	3.07		3.07	3.07	3.07	
8.5	2.76	2.76	2.76		2.76	2.76	2.76	
9.0	2.49	2.49	2.49		2.49	2.49	2.49	
9.5	2.26	2.26	2.26		2.26	2.26	2.26	
10.0	2.04	2.06	2.06		2.04	2.06	2.06	
10.5	1.83	1.89	1.89		1.82	1.89	1.89	
11.0	1.65	1.73	1.73		1.63	1.73	1.73	
11.5	1.50	1.60	1.60		1.46	1.60	1.60	
12.0	1.36	1.47	1.47		1.31	1.46	1.47	
12.5	1.24	1.35	1.35		1.19	1.33	1.35	
13.0	1.14	1.25	1.25		1.07	1.22	1.25	
13.5	1.05	1.16	1.16		0.97	1.12	1.16	
14.0	0.96	1.08	1.08		0.88	1.03	1.08	
14.5	0.89	1.00	1.00		0.78	0.94	1.00	
15.0	0.82	0.93	0.94		0.70	0.87	0.93	
15.5	0.76	0.87	0.88		0.62	0.80	0.87	
16.0	0.71	0.81	0.82		0.56	0.74	0.81	
16.5	0.66	0.76	0.77		0.51	0.69	0.75	
17.0	0.61	0.71	0.73		0.46	0.64	0.70	
17.5	0.57	0.66	0.69		0.42	0.59	0.66	
18.0	0.54	0.62	0.65		0.38	0.55	0.61	

Generally not limiting design - verify by calculation

Generally not limiting design - verify by calculation

MSS 300/18								
SPAN (m)	INWARDS			Ws kN/m	OUTWARDS			Ws kN/m
	$\phi_b w_u$ kN/m				$\phi_b w_u$ kN/m			
	1B	2B	3B		1B	2B	3B	
3.0								
3.5								
4.0								
4.5								
5.0	9.53	9.53	9.53		9.53	9.53	9.53	
5.5	8.03	8.03	8.03		8.03	8.03	8.03	
6.0	6.82	6.82	6.82		6.82	6.82	6.82	
6.5	5.95	5.94	5.94		5.95	5.94	5.94	
7.0	5.22	5.22	5.22		5.22	5.22	5.22	
7.5	4.57	4.57	4.57		4.57	4.57	4.57	
8.0	4.02	4.02	4.02		4.02	4.02	4.02	
8.5	3.56	3.56	3.56		3.56	3.56	3.56	
9.0	3.18	3.18	3.18		3.18	3.18	3.18	
9.5	2.85	2.85	2.85		2.85	2.85	2.85	
10.0	2.57	2.57	2.57		2.57	2.57	2.57	
10.5	2.32	2.33	2.33		2.33	2.33	2.33	
11.0	2.10	2.13	2.13		2.10	2.13	2.13	
11.5	1.90	1.95	1.95		1.89	1.95	1.95	
12.0	1.73	1.79	1.79		1.70	1.79	1.79	
12.5	1.58	1.65	1.65		1.54	1.65	1.65	
13.0	1.45	1.52	1.52		1.40	1.52	1.52	
13.5	1.33	1.41	1.41		1.27	1.41	1.41	
14.0	1.23	1.31	1.31		1.15	1.31	1.31	
14.5	1.13	1.22	1.22		1.05	1.22	1.22	
15.0	1.05	1.14	1.14		0.93	1.12	1.14	
15.5	0.97	1.07	1.07		0.83	1.04	1.07	
16.0	0.91	1.01	1.01		0.74	0.96	1.01	
16.5	0.84	0.95	0.95		0.66	0.89	0.95	
17.0	0.79	0.89	0.89		0.59	0.83	0.89	
17.5	0.73	0.84	0.84		0.53	0.77	0.84	
18.0	0.69	0.79	0.79		0.48	0.72	0.79	

Generally not limiting design - verify by calculation

Generally not limiting design - verify by calculation

- 1B = One mid span brace
- 2B = Two equally spaced braces within the span
- 3B = Three equally spaced braces within the span
- w_s = Uniformly distributed serviceability load (kN/m) for deflection limit of Span/150
- $\phi_b w_u$ = Strength load resistance applied at the centroid (kN/m)

- 2-M12 Grade 4.6 bolts per connection
- 2-M12 Grade 8.8 bolts per connection
- 2-M16 Grade 4.6 bolts per connection
- 2-M16 Grade 8.8 bolts per connection

IMPORTANT

The adequacy of multispan system is very sensitive to actual applied loads. The stated loads in this table are assumed uniform over the full purlin system. Variations in actual project design loadings over the length of the purlin system must be checked specifically by the designer to verify system adequacy.

LAPPED MULTISPAN (END SPAN)

LOAD TABLE – Uniformly Distributed Load

MSS 300/23						
SPAN (m)	INWARDS			OUTWARDS		
	$\phi_b w_u$ kN/m			$\phi_b w_u$ kN/m		
	1B	2B	3B	1B	2B	3B
3.0						
3.5						
4.0						
4.5						
5.0	15.2	15.2	15.2	15.2	15.2	15.2
5.5	12.3	12.3	12.3	12.3	12.3	12.3
6.0	10.1	10.1	10.1	10.1	10.1	10.1
6.5	8.59	8.59	8.59	8.59	8.59	8.59
7.0	7.41	7.41	7.41	7.41	7.41	7.41
7.5	6.45	6.45	6.45	6.45	6.45	6.45
8.0	5.67	5.67	5.67	5.67	5.67	5.67
8.5	5.02	5.02	5.02	5.02	5.02	5.02
9.0	4.48	4.48	4.48	4.48	4.48	4.48
9.5	4.02	4.02	4.02	4.02	4.02	4.02
10.0	3.63	3.63	3.63	3.63	3.63	3.63
10.5	3.29	3.29	3.29	3.29	3.29	3.29
11.0	3.00	3.00	3.00	3.00	3.00	3.00
11.5	2.75	2.75	2.75	2.75	2.75	2.75
12.0	2.52	2.52	2.52	2.52	2.52	2.52
12.5	2.31	2.32	2.32	2.30	2.32	2.32
13.0	2.11	2.15	2.15	2.07	2.15	2.15
13.5	1.93	1.99	1.99	1.86	1.99	1.99
14.0	1.77	1.85	1.85	1.63	1.85	1.85
14.5	1.62	1.73	1.73	1.43	1.73	1.73
15.0	1.50	1.61	1.61	1.26	1.61	1.61
15.5	1.38	1.51	1.51	1.11	1.51	1.51
16.0	1.28	1.42	1.42	0.98	1.42	1.42
16.5	1.18	1.33	1.33	0.87	1.33	1.33
17.0	1.10	1.26	1.26	0.77	1.24	1.26
17.5	1.02	1.19	1.19	0.69	1.14	1.19
18.0	0.95	1.12	1.12	0.62	1.06	1.12

Generally not limiting design - verify by calculation

Generally not limiting design - verify by calculation

MSS 300/24						
SPAN (m)	INWARDS			OUTWARDS		
	$\phi_b w_u$ kN/m			$\phi_b w_u$ kN/m		
	1B	2B	3B	1B	2B	3B
3.0						
3.5						
4.0						
4.5						
5.0	16.6	16.6	16.6	16.6	16.6	16.6
5.5	13.4	13.4	13.4	13.4	13.4	13.4
6.0	11.0	11.0	11.0	11.0	11.0	11.0
6.5	9.40	9.40	9.40	9.40	9.40	9.40
7.0	8.11	8.11	8.11	8.11	8.11	8.11
7.5	7.06	7.06	7.06	7.06	7.06	7.06
8.0	6.21	6.21	6.21	6.21	6.21	6.21
8.5	5.50	5.50	5.50	5.50	5.50	5.50
9.0	4.90	4.90	4.90	4.90	4.90	4.90
9.5	4.40	4.40	4.40	4.40	4.40	4.40
10.0	3.97	3.97	3.97	3.97	3.97	3.97
10.5	3.60	3.60	3.60	3.60	3.60	3.60
11.0	3.28	3.28	3.28	3.28	3.28	3.28
11.5	3.00	3.00	3.00	3.00	3.00	3.00
12.0	2.72	2.76	2.76	2.76	2.76	2.76
12.5	2.47	2.54	2.54	2.48	2.54	2.54
13.0	2.25	2.35	2.35	2.23	2.35	2.35
13.5	2.06	2.18	2.18	2.01	2.18	2.18
14.0	1.89	2.03	2.03	1.75	2.03	2.03
14.5	1.74	1.89	1.89	1.53	1.89	1.89
15.0	1.60	1.77	1.77	1.34	1.77	1.77
15.5	1.48	1.65	1.65	1.18	1.65	1.65
16.0	1.36	1.55	1.55	1.04	1.55	1.55
16.5	1.26	1.46	1.46	0.93	1.44	1.46
17.0	1.17	1.37	1.37	0.83	1.33	1.37
17.5	1.09	1.30	1.30	0.74	1.24	1.30
18.0	1.01	1.23	1.23	0.66	1.14	1.23

Generally not limiting design - verify by calculation

Generally not limiting design - verify by calculation

- 1B = One mid span brace
- 2B = Two equally spaced braces within the span
- 3B = Three equally spaced braces within the span
- w_s = Uniformly distributed serviceability load (kN/m) for deflection limit of Span/150
- $\phi_b w_u$ = Strength load resistance applied at the centroid (kN/m)

- 2-M12 Grade 4.6 bolts per connection
- 2-M12 Grade 8.8 bolts per connection
- 2-M16 Grade 4.6 bolts per connection
- 2-M16 Grade 8.8 bolts per connection

IMPORTANT

The adequacy of multispan system is very sensitive to actual applied loads. The stated loads in this table are assumed uniform over the full purlin system. Variations in actual project design loadings over the length of the purlin system must be checked specifically by the designer to verify system adequacy.

LAPPED MULTISPAN (END SPAN)

LOAD TABLE – Uniformly Distributed Load

MSS 300/30								
SPAN (m)	INWARDS			Ws kN/m	OUTWARDS			Ws kN/m
	$\phi_b w_u$ kN/m				$\phi_b w_u$ kN/m			
	1B	2B	3B		1B	2B	3B	
3.0								
3.5								
4.0								
4.5								
5.0	18.7	18.7	18.7		18.7	18.7	18.7	
5.5	17.0	17.0	17.0		17.0	17.0	17.0	
6.0	14.5	14.5	14.5		14.5	14.5	14.5	
6.5	12.4	12.4	12.4		12.4	12.4	12.4	
7.0	10.7	10.7	10.7		10.7	10.7	10.7	
7.5	9.28	9.28	9.28		9.28	9.28	9.28	
8.0	8.16	8.16	8.16		8.16	8.16	8.16	
8.5	7.23	7.23	7.23		7.23	7.23	7.23	
9.0	6.44	6.44	6.44		6.44	6.44	6.44	
9.5	5.78	5.78	5.78		5.78	5.78	5.78	
10.0	5.22	5.22	5.22		5.22	5.22	5.22	
10.5	4.65	4.74	4.74		4.74	4.74	4.74	
11.0	4.16	4.31	4.31		4.31	4.31	4.31	
11.5	3.74	3.95	3.95		3.92	3.95	3.95	
12.0	3.37	3.63	3.63		3.51	3.63	3.63	
12.5	3.05	3.34	3.34		3.15	3.34	3.34	
13.0	2.77	3.09	3.09		2.82	3.09	3.09	
13.5	2.52	2.86	2.86		2.46	2.86	2.86	
14.0	2.30	2.66	2.66		2.14	2.66	2.66	
14.5	2.11	2.48	2.48		1.87	2.48	2.48	
15.0	1.93	2.32	2.32		1.64	2.32	2.32	
15.5	1.78	2.17	2.17		1.45	2.17	2.17	
16.0	1.64	2.04	2.04		1.28	2.00	2.04	
16.5	1.51	1.92	1.92		1.14	1.84	1.92	
17.0	1.40	1.81	1.81		1.02	1.70	1.81	
17.5	1.29	1.70	1.70		0.91	1.56	1.70	
18.0	1.20	1.61	1.61		0.82	1.43	1.61	

Generally not limiting design - verify by calculation

Generally not limiting design - verify by calculation

MSS 325/15								
SPAN (m)	INWARDS			Ws kN/m	OUTWARDS			Ws kN/m
	$\phi_b w_u$ kN/m				$\phi_b w_u$ kN/m			
	1B	2B	3B		1B	2B	3B	
3.0								
3.5								
4.0								
4.5								
5.0	6.99	6.99	6.99		6.99	6.99	6.99	
5.5	5.99	5.99	5.99		5.99	5.99	5.99	
6.0	5.17	5.17	5.16		5.17	5.17	5.16	
6.5	4.55	4.55	4.55		4.55	4.55	4.55	
7.0	4.04	4.04	4.04		4.04	4.04	4.04	
7.5	3.61	3.61	3.61		3.61	3.61	3.61	
8.0	3.24	3.24	3.24		3.24	3.24	3.24	
8.5	2.92	2.92	2.92		2.92	2.92	2.92	
9.0	2.64	2.64	2.64		2.64	2.64	2.64	
9.5	2.41	2.41	2.41		2.41	2.41	2.41	
10.0	2.20	2.20	2.20		2.20	2.20	2.20	
10.5	1.99	2.01	2.01		1.98	2.01	2.01	
11.0	1.79	1.85	1.85		1.77	1.85	1.85	
11.5	1.63	1.71	1.71		1.59	1.71	1.71	
12.0	1.48	1.58	1.58		1.43	1.58	1.58	
12.5	1.35	1.47	1.47		1.29	1.45	1.47	
13.0	1.24	1.36	1.36		1.16	1.33	1.36	
13.5	1.14	1.26	1.26		1.05	1.22	1.26	
14.0	1.05	1.17	1.17		0.94	1.12	1.17	
14.5	0.96	1.09	1.09		0.84	1.03	1.09	
15.0	0.89	1.01	1.02		0.75	0.95	1.02	
15.5	0.83	0.94	0.95		0.67	0.87	0.94	
16.0	0.77	0.88	0.89		0.60	0.81	0.88	
16.5	0.71	0.82	0.84		0.55	0.75	0.82	
17.0	0.66	0.77	0.79		0.49	0.69	0.76	
17.5	0.62	0.72	0.75		0.45	0.64	0.71	
18.0	0.58	0.67	0.71		0.41	0.59	0.67	

Generally not limiting design - verify by calculation

Generally not limiting design - verify by calculation

- 1B = One mid span brace
- 2B = Two equally spaced braces within the span
- 3B = Three equally spaced braces within the span
- w_s = Uniformly distributed serviceability load (kN/m) for deflection limit of Span/150
- $\phi_b w_u$ = Strength load resistance applied at the centroid (kN/m)

- 2-M12 Grade 4.6 bolts per connection
- 2-M12 Grade 8.8 bolts per connection
- 2-M16 Grade 4.6 bolts per connection
- 2-M16 Grade 8.8 bolts per connection

IMPORTANT

The adequacy of multispan system is very sensitive to actual applied loads. The stated loads in this table are assumed uniform over the full purlin system. Variations in actual project design loadings over the length of the purlin system must be checked specifically by the designer to verify system adequacy.

LAPPED MULTISPAN (END SPAN)

LOAD TABLE – Uniformly Distributed Load

MSS 325/18								
SPAN (m)	INWARDS			Ws kN/m	OUTWARDS			Ws kN/m
	$\phi_b w_u$ kN/m				$\phi_b w_u$ kN/m			
	1B	2B	3B		1B	2B	3B	
3.0								
3.5								
4.0								
4.5								
5.0	9.90	9.90	9.89		9.90	9.90	9.89	
5.5	8.38	8.38	8.38		8.38	8.38	8.38	
6.0	7.16	7.16	7.16		7.16	7.16	7.16	
6.5	6.26	6.26	6.26		6.26	6.26	6.26	
7.0	5.52	5.52	5.52		5.52	5.52	5.52	
7.5	4.90	4.90	4.90		4.90	4.90	4.90	
8.0	4.37	4.37	4.37		4.37	4.37	4.37	
8.5	3.87	3.87	3.87		3.87	3.87	3.87	
9.0	3.45	3.45	3.45		3.45	3.45	3.45	
9.5	3.10	3.10	3.10		3.10	3.10	3.10	
10.0	2.80	2.80	2.80		2.80	2.80	2.80	
10.5	2.52	2.54	2.54		2.54	2.54	2.54	
11.0	2.27	2.31	2.31		2.27	2.31	2.31	
11.5	2.06	2.11	2.11		2.05	2.11	2.11	
12.0	1.87	1.94	1.94		1.85	1.94	1.94	
12.5	1.71	1.79	1.79		1.67	1.79	1.79	
13.0	1.57	1.65	1.65		1.51	1.65	1.65	
13.5	1.44	1.53	1.53		1.37	1.53	1.53	
14.0	1.33	1.43	1.43		1.25	1.43	1.43	
14.5	1.23	1.33	1.33		1.13	1.32	1.33	
15.0	1.13	1.24	1.24		1.02	1.22	1.24	
15.5	1.05	1.16	1.16		0.91	1.13	1.16	
16.0	0.98	1.09	1.09		0.81	1.04	1.09	
16.5	0.91	1.03	1.03		0.72	0.97	1.03	
17.0	0.85	0.97	0.97		0.65	0.90	0.97	
17.5	0.79	0.91	0.91		0.58	0.83	0.91	
18.0	0.74	0.86	0.86		0.52	0.78	0.86	

Generally not limiting design - verify by calculation

Generally not limiting design - verify by calculation

MSS 350/18								
SPAN (m)	INWARDS			Ws kN/m	OUTWARDS			Ws kN/m
	$\phi_b w_u$ kN/m				$\phi_b w_u$ kN/m			
	1B	2B	3B		1B	2B	3B	
3.0								
3.5								
4.0								
4.5								
5.0								
5.5								
6.0	7.00	7.00	7.00		7.00	7.00	7.00	
6.5	6.18	6.18	6.18		6.18	6.18	6.18	
7.0	5.49	5.49	5.49		5.49	5.49	5.49	
7.5	4.91	4.91	4.91		4.91	4.91	4.91	
8.0	4.42	4.42	4.42		4.42	4.42	4.42	
8.5	3.99	3.99	3.99		3.99	3.99	3.99	
9.0	3.62	3.62	3.62		3.62	3.62	3.62	
9.5	3.29	3.30	3.30		3.29	3.30	3.30	
10.0	3.01	3.01	3.01		3.01	3.01	3.01	
10.5	2.76	2.76	2.76		2.76	2.76	2.76	
11.0	2.53	2.54	2.54		2.54	2.54	2.54	
11.5	2.29	2.35	2.35		2.29	2.35	2.35	
12.0	2.08	2.17	2.17		2.06	2.17	2.17	
12.5	1.90	2.00	2.00		1.87	2.00	2.00	
13.0	1.74	1.85	1.85		1.69	1.85	1.85	
13.5	1.60	1.72	1.72		1.53	1.72	1.72	
14.0	1.47	1.59	1.59		1.39	1.59	1.59	
14.5	1.35	1.49	1.49		1.27	1.47	1.49	
15.0	1.25	1.39	1.39		1.14	1.36	1.39	
15.5	1.16	1.30	1.30		1.03	1.26	1.30	
16.0	1.08	1.22	1.22		0.92	1.17	1.22	
16.5	1.00	1.15	1.15		0.83	1.08	1.15	
17.0	0.93	1.08	1.08		0.76	1.00	1.08	
17.5	0.87	1.02	1.02		0.68	0.93	1.02	
18.0	0.81	0.96	0.96		0.61	0.87	0.95	

Generally not limiting design - verify by calculation

Generally not limiting design - verify by calculation

- 1B = One mid span brace
- 2B = Two equally spaced braces within the span
- 3B = Three equally spaced braces within the span
- w_s = Uniformly distributed serviceability load (kN/m) for deflection limit of Span/150
- $\phi_b w_u$ = Strength load resistance applied at the centroid (kN/m)

- 2-M12 Grade 4.6 bolts per connection
- 2-M12 Grade 8.8 bolts per connection
- 2-M16 Grade 4.6 bolts per connection
- 2-M16 Grade 8.8 bolts per connection

IMPORTANT

The adequacy of multispan system is very sensitive to actual applied loads. The stated loads in this table are assumed uniform over the full purlin system. Variations in actual project design loadings over the length of the purlin system must be checked specifically by the designer to verify system adequacy.

LAPPED MULTISPAN (END SPAN)

LOAD TABLE – Uniformly Distributed Load

MSS 350/23								
SPAN (m)	INWARDS			Ws kN/m	OUTWARDS			Ws kN/m
	$\phi_b w_u$ kN/m				$\phi_b w_u$ kN/m			
	1B	2B	3B		1B	2B	3B	
3.0								
3.5								
4.0								
4.5								
5.0								
5.5								
6.0	11.6	11.6	11.6		11.6	11.6	11.6	
6.5	10.2	10.2	10.2		10.2	10.2	10.2	
7.0	8.97	8.97	8.97		8.97	8.97	8.97	
7.5	7.85	7.85	7.85		7.85	7.85	7.85	
8.0	6.90	6.90	6.90		6.90	6.90	6.90	
8.5	6.11	6.11	6.11		6.11	6.11	6.11	
9.0	5.45	5.45	5.45		5.45	5.45	5.45	
9.5	4.89	4.89	4.89		4.89	4.89	4.89	
10.0	4.42	4.42	4.42		4.42	4.42	4.42	
10.5	4.01	4.01	4.01		4.01	4.01	4.01	
11.0	3.65	3.65	3.65		3.65	3.65	3.65	
11.5	3.33	3.34	3.34		3.34	3.34	3.34	
12.0	3.02	3.07	3.07		3.07	3.07	3.07	
12.5	2.76	2.83	2.83		2.78	2.83	2.83	
13.0	2.52	2.61	2.61		2.52	2.61	2.61	
13.5	2.31	2.42	2.42		2.28	2.42	2.42	
14.0	2.12	2.25	2.25		2.08	2.25	2.25	
14.5	1.96	2.10	2.10		1.83	2.10	2.10	
15.0	1.81	1.96	1.96		1.62	1.96	1.96	
15.5	1.67	1.84	1.84		1.42	1.84	1.84	
16.0	1.55	1.73	1.73		1.26	1.73	1.73	
16.5	1.44	1.62	1.62		1.11	1.61	1.62	
17.0	1.34	1.53	1.53		0.99	1.50	1.53	
17.5	1.25	1.44	1.44		0.89	1.39	1.44	
18.0	1.17	1.36	1.36		0.79	1.29	1.36	

Generally not limiting design - verify by calculation

Generally not limiting design - verify by calculation

MSS 350/24								
SPAN (m)	INWARDS			Ws kN/m	OUTWARDS			Ws kN/m
	$\phi_b w_u$ kN/m				$\phi_b w_u$ kN/m			
	1B	2B	3B		1B	2B	3B	
3.0								
3.5								
4.0								
4.5								
5.0								
5.5								
6.0	13.1	13.1	13.1		13.1	13.1	13.1	
6.5	11.4	11.4	11.4		11.4	11.4	11.4	
7.0	9.84	9.84	9.84		9.84	9.84	9.84	
7.5	8.57	8.57	8.57		8.57	8.57	8.57	
8.0	7.54	7.54	7.54		7.54	7.54	7.54	
8.5	6.68	6.68	6.68		6.68	6.68	6.68	
9.0	5.95	5.95	5.95		5.95	5.95	5.95	
9.5	5.34	5.34	5.34		5.34	5.34	5.34	
10.0	4.82	4.82	4.82		4.82	4.82	4.82	
10.5	4.37	4.37	4.37		4.37	4.37	4.37	
11.0	3.99	3.99	3.99		3.99	3.99	3.99	
11.5	3.65	3.65	3.65		3.65	3.65	3.65	
12.0	3.34	3.35	3.35		3.35	3.35	3.35	
12.5	3.04	3.09	3.09		3.08	3.09	3.09	
13.0	2.78	2.85	2.85		2.79	2.85	2.85	
13.5	2.55	2.65	2.65		2.54	2.65	2.65	
14.0	2.34	2.46	2.46		2.25	2.46	2.46	
14.5	2.16	2.29	2.29		1.96	2.29	2.29	
15.0	1.98	2.14	2.14		1.72	2.14	2.14	
15.5	1.83	2.01	2.01		1.51	2.01	2.01	
16.0	1.69	1.88	1.88		1.34	1.88	1.88	
16.5	1.56	1.77	1.77		1.19	1.77	1.77	
17.0	1.45	1.67	1.67		1.06	1.66	1.67	
17.5	1.34	1.58	1.58		0.94	1.55	1.58	
18.0	1.25	1.49	1.49		0.85	1.44	1.49	

Generally not limiting design - verify by calculation

Generally not limiting design - verify by calculation

- 1B = One mid span brace
- 2B = Two equally spaced braces within the span
- 3B = Three equally spaced braces within the span
- w_s = Uniformly distributed serviceability load (kN/m) for deflection limit of Span/150
- $\phi_b w_u$ = Strength load resistance applied at the centroid (kN/m)

- 2-M12 Grade 4.6 bolts per connection
- 2-M12 Grade 8.8 bolts per connection
- 2-M16 Grade 4.6 bolts per connection
- 2-M16 Grade 8.8 bolts per connection

IMPORTANT

The adequacy of multispan system is very sensitive to actual applied loads. The stated loads in this table are assumed uniform over the full purlin system. Variations in actual project design loadings over the length of the purlin system must be checked specifically by the designer to verify system adequacy.

LAPPED MULTISPAN (END SPAN)

LOAD TABLE – Uniformly Distributed Load

MSS 350/30								
SPAN (m)	INWARDS			Ws kN/m	OUTWARDS			Ws kN/m
	$\phi_b w_u$ kN/m				$\phi_b w_u$ kN/m			
	1B	2B	3B		1B	2B	3B	
3.0								
3.5								
4.0								
4.5								
5.0								
5.5								
6.0	15.6	15.6	15.6		15.6	15.6	15.6	
6.5	14.4	14.4	14.4		14.4	14.4	14.4	
7.0	13.0	13.0	13.0		13.0	13.0	13.0	
7.5	11.3	11.3	11.3		11.3	11.3	11.3	
8.0	9.95	9.95	9.95		9.95	9.95	9.95	
8.5	8.81	8.81	8.81		8.81	8.81	8.81	
9.0	7.86	7.86	7.86		7.86	7.86	7.86	
9.5	7.05	7.05	7.05		7.05	7.05	7.05	
10.0	6.37	6.37	6.37		6.37	6.37	6.37	
10.5	5.77	5.77	5.77		5.77	5.77	5.77	
11.0	5.19	5.26	5.26		5.26	5.26	5.26	
11.5	4.65	4.81	4.81		4.81	4.81	4.81	
12.0	4.19	4.42	4.42		4.42	4.42	4.42	
12.5	3.79	4.07	4.07		3.98	4.07	4.07	
13.0	3.43	3.77	3.77		3.57	3.77	3.77	
13.5	3.12	3.49	3.49		3.15	3.49	3.49	
14.0	2.84	3.25	3.25		2.75	3.25	3.25	
14.5	2.60	3.03	3.03		2.40	3.03	3.03	
15.0	2.38	2.83	2.83		2.10	2.83	2.83	
15.5	2.19	2.65	2.65		1.85	2.65	2.65	
16.0	2.01	2.49	2.49		1.64	2.49	2.49	
16.5	1.85	2.34	2.34		1.45	2.33	2.34	
17.0	1.71	2.20	2.20		1.29	2.15	2.20	
17.5	1.58	2.08	2.08		1.16	1.98	2.08	
18.0	1.46	1.97	1.97		1.04	1.83	1.97	

Generally not limiting design - verify by calculation

Generally not limiting design - verify by calculation

MSS 400/20								
SPAN (m)	INWARDS			Ws kN/m	OUTWARDS			Ws kN/m
	$\phi_b w_u$ kN/m				$\phi_b w_u$ kN/m			
	1B	2B	3B		1B	2B	3B	
3.0								
3.5								
4.0								
4.5								
5.0								
5.5								
6.0	8.13	8.13	8.13		8.13	8.13	8.13	
6.5	7.27	7.27	7.27		7.27	7.27	7.27	
7.0	6.53	6.53	6.53		6.53	6.53	6.53	
7.5	5.90	5.90	5.90		5.90	5.90	5.90	
8.0	5.35	5.35	5.35		5.35	5.35	5.35	
8.5	4.88	4.88	4.88		4.88	4.88	4.88	
9.0	4.46	4.46	4.46		4.46	4.46	4.46	
9.5	4.09	4.09	4.09		4.09	4.09	4.09	
10.0	3.77	3.77	3.77		3.77	3.77	3.77	
10.5	3.48	3.48	3.47		3.48	3.48	3.47	
11.0	3.22	3.22	3.22		3.22	3.22	3.22	
11.5	2.98	2.99	2.99		2.98	2.99	2.99	
12.0	2.78	2.78	2.78		2.78	2.78	2.78	
12.5	2.55	2.59	2.59		2.55	2.59	2.59	
13.0	2.34	2.42	2.42		2.32	2.42	2.42	
13.5	2.15	2.26	2.26		2.12	2.26	2.26	
14.0	1.98	2.12	2.12		1.93	2.12	2.12	
14.5	1.83	1.99	2.00		1.76	1.99	2.00	
15.0	1.69	1.88	1.88		1.59	1.86	1.88	
15.5	1.57	1.76	1.76		1.42	1.72	1.76	
16.0	1.45	1.65	1.65		1.28	1.59	1.65	
16.5	1.35	1.55	1.55		1.16	1.48	1.55	
17.0	1.25	1.46	1.46		1.05	1.38	1.46	
17.5	1.17	1.38	1.38		0.94	1.28	1.38	
18.0	1.09	1.29	1.31		0.85	1.20	1.30	

Generally not limiting design - verify by calculation

Generally not limiting design - verify by calculation

- 1B = One mid span brace
- 2B = Two equally spaced braces within the span
- 3B = Three equally spaced braces within the span
- w_s = Uniformly distributed serviceability load (kN/m) for deflection limit of Span/150
- $\phi_b w_u$ = Strength load resistance applied at the centroid (kN/m)

- 2-M12 Grade 4.6 bolts per connection
- 2-M12 Grade 8.8 bolts per connection
- 2-M16 Grade 4.6 bolts per connection
- 2-M16 Grade 8.8 bolts per connection

IMPORTANT

The adequacy of multispan system is very sensitive to actual applied loads. The stated loads in this table are assumed uniform over the full purlin system. Variations in actual project design loadings over the length of the purlin system must be checked specifically by the designer to verify system adequacy.

LAPPED MULTISPAN (END SPAN)

LOAD TABLE – Uniformly Distributed Load

MSS 400/23								
SPAN (m)	INWARDS			Ws kN/m	OUTWARDS			Ws kN/m
	$\phi_b w_u$ kN/m				$\phi_b w_u$ kN/m			
	1B	2B	3B		1B	2B	3B	
3.0								
3.5								
4.0								
4.5								
5.0								
5.5								
6.0	11.1	11.1	11.1		11.1	11.1	11.1	
6.5	9.88	9.88	9.88		9.88	9.88	9.88	
7.0	8.85	8.85	8.85		8.85	8.85	8.85	
7.5	7.97	7.96	7.97		7.97	7.96	7.97	
8.0	7.20	7.20	7.20		7.20	7.20	7.20	
8.5	6.54	6.54	6.54		6.54	6.54	6.54	
9.0	5.96	5.96	5.96		5.96	5.96	5.96	
9.5	5.46	5.46	5.46		5.46	5.46	5.46	
10.0	5.01	5.01	5.01		5.01	5.01	5.01	
10.5	4.61	4.61	4.61		4.61	4.61	4.61	
11.0	4.26	4.26	4.26		4.26	4.26	4.26	
11.5	3.85	3.90	3.90		3.90	3.90	3.90	
12.0	3.49	3.58	3.58		3.57	3.58	3.58	
12.5	3.18	3.30	3.30		3.23	3.30	3.30	
13.0	2.90	3.05	3.05		2.93	3.05	3.05	
13.5	2.66	2.83	2.83		2.66	2.83	2.83	
14.0	2.44	2.63	2.63		2.41	2.63	2.63	
14.5	2.25	2.45	2.45		2.20	2.45	2.45	
15.0	2.07	2.29	2.29		1.98	2.29	2.29	
15.5	1.92	2.15	2.15		1.75	2.15	2.15	
16.0	1.78	2.01	2.01		1.54	2.01	2.01	
16.5	1.65	1.89	1.89		1.37	1.88	1.89	
17.0	1.53	1.78	1.78		1.22	1.74	1.78	
17.5	1.43	1.68	1.68		1.09	1.62	1.68	
18.0	1.33	1.59	1.59		0.97	1.51	1.59	

MSS 400/24								
SPAN (m)	INWARDS			Ws kN/m	OUTWARDS			Ws kN/m
	$\phi_b w_u$ kN/m				$\phi_b w_u$ kN/m			
	1B	2B	3B		1B	2B	3B	
3.0								
3.5								
4.0								
4.5								
5.0								
5.5								
6.0	12.8	12.8	12.8		12.8	12.8	12.8	
6.5	11.3	11.3	11.3		11.3	11.3	11.3	
7.0	10.1	10.1	10.1		10.1	10.1	10.1	
7.5	9.11	9.11	9.11		9.11	9.11	9.11	
8.0	8.23	8.23	8.23		8.23	8.23	8.23	
8.5	7.46	7.46	7.46		7.46	7.46	7.46	
9.0	6.80	6.80	6.80		6.80	6.80	6.80	
9.5	6.21	6.21	6.21		6.21	6.21	6.21	
10.0	5.63	5.63	5.63		5.63	5.63	5.63	
10.5	5.11	5.11	5.11		5.11	5.11	5.11	
11.0	4.65	4.65	4.65		4.65	4.65	4.65	
11.5	4.24	4.26	4.26		4.26	4.26	4.26	
12.0	3.84	3.91	3.91		3.91	3.91	3.91	
12.5	3.50	3.60	3.60		3.58	3.60	3.60	
13.0	3.19	3.33	3.33		3.24	3.33	3.33	
13.5	2.92	3.09	3.09		2.94	3.09	3.09	
14.0	2.68	2.87	2.87		2.67	2.87	2.87	
14.5	2.47	2.68	2.68		2.41	2.68	2.68	
15.0	2.28	2.50	2.50		2.11	2.50	2.50	
15.5	2.10	2.34	2.34		1.86	2.34	2.34	
16.0	1.95	2.20	2.20		1.64	2.20	2.20	
16.5	1.81	2.07	2.07		1.45	2.07	2.07	
17.0	1.68	1.95	1.95		1.29	1.93	1.95	
17.5	1.56	1.84	1.84		1.16	1.79	1.84	
18.0	1.46	1.74	1.74		1.04	1.67	1.74	

- 1B = One mid span brace
- 2B = Two equally spaced braces within the span
- 3B = Three equally spaced braces within the span
- w_s = Uniformly distributed serviceability load (kN/m) for deflection limit of Span/150
- $\phi_b w_u$ = Strength load resistance applied at the centroid (kN/m)

- 2-M12 Grade 4.6 bolts per connection
- 2-M12 Grade 8.8 bolts per connection
- 2-M16 Grade 4.6 bolts per connection
- 2-M16 Grade 8.8 bolts per connection

IMPORTANT

The adequacy of multispan system is very sensitive to actual applied loads. The stated loads in this table are assumed uniform over the full purlin system. Variations in actual project design loadings over the length of the purlin system must be checked specifically by the designer to verify system adequacy.

LAPPED MULTISPAN (END SPAN)

LOAD TABLE – Uniformly Distributed Load

MSS 400/30										
SPAN (m)	INWARDS				W _s kN/m	OUTWARDS				W _s kN/m
	Φ _b W _u kN/m			W _s kN/m		Φ _b W _u kN/m			W _s kN/m	
	1B	2B	3B			1B	2B	3B		
3.0										
3.5										
4.0										
4.5										
5.0										
5.5										
6.0	15.6	15.6	15.6			15.6	15.6	15.6		
6.5	14.4	14.4	14.4			14.4	14.4	14.4		
7.0	13.4	13.4	13.4			13.4	13.4	13.4		
7.5	12.5	12.5	12.5			12.5	12.5	12.5		
8.0	11.7	11.7	11.7			11.7	11.7	11.7		
8.5	10.3	10.3	10.3			10.3	10.3	10.3		
9.0	9.21	9.21	9.21			9.21	9.21	9.21		
9.5	8.26	8.26	8.26			8.26	8.26	8.26		
10.0	7.46	7.46	7.46			7.46	7.46	7.46		
10.5	6.77	6.77	6.77			6.77	6.77	6.77		
11.0	6.16	6.16	6.16			6.16	6.16	6.16		
11.5	5.62	5.64	5.64			5.64	5.64	5.64		
12.0	5.06	5.18	5.18			5.18	5.18	5.18		
12.5	4.56	4.77	4.77			4.77	4.77	4.77		
13.0	4.13	4.41	4.41			4.41	4.41	4.41		
13.5	3.75	4.09	4.09			4.09	4.09	4.09		
14.0	3.41	3.81	3.81			3.81	3.81	3.81		
14.5	3.11	3.55	3.55			3.55	3.55	3.55		
15.0	2.85	3.32	3.32			3.32	3.32	3.32		
15.5	2.61	3.10	3.10			3.10	3.10	3.10		
16.0	2.39	2.91	2.91			2.91	2.91	2.91		
16.5	2.20	2.74	2.74			2.74	2.74	2.74		
17.0	2.03	2.58	2.58			2.58	2.58	2.58		
17.5	1.87	2.44	2.44			2.44	2.44	2.44		
18.0	1.73	2.30	2.30			2.30	2.30	2.30		

Generally not limiting design - verify by calculation

Generally not limiting design - verify by calculation

- 1B = One mid span brace
- 2B = Two equally spaced braces within the span
- 3B = Three equally spaced braces within the span
- w_s = Uniformly distributed serviceability load (kN/m) for deflection limit of Span/150
- Φ_bW_u = Strength load resistance applied at the centroid (kN/m)

- 2-M12 Grade 4.6 bolts per connection
- 2-M12 Grade 8.8 bolts per connection
- 2-M16 Grade 4.6 bolts per connection
- 2-M16 Grade 8.8 bolts per connection

IMPORTANT

The adequacy of multispan system is very sensitive to actual applied loads. The stated loads in this table are assumed uniform over the full purlin system. Variations in actual project design loadings over the length of the purlin system must be checked specifically by the designer to verify system adequacy.

LAPPED MULTISPAN (INTERNAL SPANS)

LOAD TABLE – Uniformly Distributed Load

MSS 150/12								
SPAN (m)	INWARDS			Ws kN/m	OUTWARDS			Ws kN/m
	$\phi_b w_u$ kN/m				$\phi_b w_u$ kN/m			
	1B	2B	3B		1B	2B	3B	
3.0	13.1	13.1	13.1	Generally not limiting design - verify by calculation	13.1	13.1	13.1	Generally not limiting design - verify by calculation
3.5	8.88	8.88	8.88		8.88	8.88	8.88	
4.0	6.46	6.46	6.46		6.46	6.46	6.46	
4.5	4.86	4.86	4.86		4.86	4.86	4.86	
5.0	3.84	3.84	3.84		3.84	3.84	3.84	
5.5	3.10	3.10	3.10		3.10	3.10	3.10	
6.0	2.55	2.55	2.55		2.55	2.55	2.55	
6.5	2.17	2.17	2.17		2.17	2.17	2.17	
7.0	1.87	1.87	1.87		1.87	1.87	1.87	
7.5	1.63	1.63	1.63		1.63	1.63	1.63	
8.0	1.43	1.43	1.43		1.40	1.43	1.43	
8.5	1.27	1.27	1.27		1.20	1.27	1.27	
9.0	1.13	1.13	1.13		1.08	1.13	1.13	
9.5	1.02	1.02	1.02		0.96	1.02	1.02	
10.0	0.92	0.92	0.92		0.86	0.90	0.92	
10.5	0.84	0.83	0.83		0.76	0.80	0.83	
11.0	0.76	0.76	0.76		0.68	0.72	0.76	
11.5								
12.0								
12.5								
13.0								
13.5								
14.0								
14.5								
15.0								
15.5								
16.0								
16.5								
17.0								
17.5								
18.0								

MSS 150/15								
SPAN (m)	INWARDS			Ws kN/m	OUTWARDS			Ws kN/m
	$\phi_b w_u$ kN/m				$\phi_b w_u$ kN/m			
	1B	2B	3B		1B	2B	3B	
3.0	17.9	17.9	17.9	Generally not limiting design - verify by calculation	17.9	17.9	17.9	Generally not limiting design - verify by calculation
3.5	12.1	12.1	12.1		12.1	12.1	12.1	
4.0	8.83	8.83	8.83		8.83	8.83	8.83	
4.5	6.64	6.64	6.64		6.64	6.64	6.64	
5.0	5.25	5.25	5.25		5.25	5.25	5.25	
5.5	4.24	4.24	4.24		4.24	4.24	4.24	
6.0	3.48	3.48	3.48		3.48	3.48	3.48	
6.5	2.97	2.97	2.97		2.97	2.97	2.97	
7.0	2.56	2.56	2.56		2.56	2.56	2.56	
7.5	2.23	2.23	2.23		2.23	2.23	2.23	
8.0	1.96	1.96	1.96		1.92	1.96	1.96	
8.5	1.74	1.74	1.74		1.63	1.74	1.74	
9.0	1.55	1.55	1.55		1.47	1.55	1.55	
9.5	1.39	1.39	1.39		1.31	1.39	1.39	
10.0	1.27	1.25	1.25		1.17	1.24	1.25	
10.5	1.14	1.14	1.14		1.03	1.10	1.14	
11.0	1.02	1.04	1.04		0.90	0.97	1.04	
11.5								
12.0								
12.5								
13.0								
13.5								
14.0								
14.5								
15.0								
15.5								
16.0								
16.5								
17.0								
17.5								
18.0								

- 1B = One mid span brace
- 2B = Two equally spaced braces within the span
- 3B = Three equally spaced braces within the span
- w_s = Uniformly distributed serviceability load (kN/m) for deflection limit of Span/150
- $\phi_b w_u$ = Strength load resistance applied at the centroid (kN/m)

- 2-M12 Grade 4.6 bolts per connection
- 2-M12 Grade 8.8 bolts per connection
- 2-M16 Grade 4.6 bolts per connection
- 2-M16 Grade 8.8 bolts per connection

IMPORTANT

The adequacy of multispans system is very sensitive to actual applied loads. The stated loads in this table are assumed uniform over the full purlin system. Variations in actual project design loadings over the length of the purlin system must be checked specifically by the designer to verify system adequacy.

LAPPED MULTISPAN (INTERNAL SPANS)

LOAD TABLE – Uniformly Distributed Load

MSS 150/18								
SPAN (m)	INWARDS			Ws kN/m	OUTWARDS			Ws kN/m
	$\phi_b w_u$ kN/m				$\phi_b w_u$ kN/m			
	1B	2B	3B		1B	2B	3B	
3.0	21.4	21.4	21.4	Generally not limiting design - verify by calculation	21.4	21.4	21.4	Generally not limiting design - verify by calculation
3.5	14.5	14.5	14.5		14.5	14.5	14.5	
4.0	10.6	10.6	10.6		10.6	10.6	10.6	
4.5	7.94	7.94	7.94		7.94	7.94	7.94	
5.0	6.28	6.28	6.28		6.28	6.28	6.28	
5.5	5.07	5.07	5.07		5.07	5.07	5.07	
6.0	4.16	4.16	4.16		4.16	4.16	4.16	
6.5	3.54	3.54	3.54		3.54	3.54	3.54	
7.0	3.06	3.06	3.06		3.06	3.06	3.06	
7.5	2.66	2.66	2.66		2.64	2.66	2.66	
8.0	2.34	2.34	2.34		2.27	2.34	2.34	
8.5	2.08	2.07	2.07		1.95	2.07	2.07	
9.0	1.85	1.85	1.85		1.70	1.85	1.85	
9.5	1.64	1.66	1.66		1.54	1.66	1.66	
10.0	1.47	1.50	1.50		1.38	1.46	1.50	
10.5	1.32	1.36	1.36		1.22	1.30	1.36	
11.0	1.19	1.24	1.24		1.07	1.15	1.24	
11.5								
12.0								
12.5								
13.0								
13.5								
14.0								
14.5								
15.0								
15.5								
16.0								
16.5								
17.0								
17.5								
18.0								

MSS 150/23								
SPAN (m)	INWARDS			Ws kN/m	OUTWARDS			Ws kN/m
	$\phi_b w_u$ kN/m				$\phi_b w_u$ kN/m			
	1B	2B	3B		1B	2B	3B	
3.0	29.5	29.5	29.5	Generally not limiting design - verify by calculation	29.5	29.5	29.5	Generally not limiting design - verify by calculation
3.5	20.0	20.0	20.0		20.0	20.0	20.0	
4.0	14.5	14.5	14.5		14.5	14.5	14.5	
4.5	10.9	10.9	10.9		10.9	10.9	10.9	
5.0	8.64	8.64	8.64		8.64	8.64	8.64	
5.5	6.99	6.98	6.98		6.98	6.98	6.98	
6.0	5.67	5.73	5.73		5.74	5.73	5.73	
6.5	4.77	4.88	4.88		4.78	4.88	4.88	
7.0	4.06	4.21	4.21		4.02	4.21	4.21	
7.5	3.49	3.67	3.67		3.41	3.67	3.67	
8.0	3.03	3.22	3.22		2.92	3.20	3.22	
8.5	2.65	2.85	2.85		2.49	2.78	2.85	
9.0	2.33	2.55	2.55		2.10	2.43	2.55	
9.5	2.07	2.28	2.28		1.97	2.13	2.28	
10.0	1.85	2.07	2.06		1.77	1.88	2.04	
10.5	1.66	1.86	1.87		1.57	1.67	1.82	
11.0	1.49	1.68	1.70		1.38	1.48	1.63	
11.5								
12.0								
12.5								
13.0								
13.5								
14.0								
14.5								
15.0								
15.5								
16.0								
16.5								
17.0								
17.5								
18.0								

- 1B = One mid span brace
- 2B = Two equally spaced braces within the span
- 3B = Three equally spaced braces within the span
- w_s = Uniformly distributed serviceability load (kN/m) for deflection limit of Span/150
- $\phi_b w_u$ = Strength load resistance applied at the centroid (kN/m)

- 2-M12 Grade 4.6 bolts per connection
- 2-M12 Grade 8.8 bolts per connection
- 2-M16 Grade 4.6 bolts per connection
- 2-M16 Grade 8.8 bolts per connection

IMPORTANT

The adequacy of multispan system is very sensitive to actual applied loads. The stated loads in this table are assumed uniform over the full purlin system. Variations in actual project design loadings over the length of the purlin system must be checked specifically by the designer to verify system adequacy.

LAPPED MULTISPAN (INTERNAL SPANS)

LOAD TABLE – Uniformly Distributed Load

MSS 200/12								
SPAN (m)	INWARDS			Ws kN/m	OUTWARDS			Ws kN/m
	$\phi_b w_u$ kN/m				$\phi_b w_u$ kN/m			
	1B	2B	3B		1B	2B	3B	
3.0	14.7	14.7	14.7	Generally not limiting design - verify by calculation	14.7	14.7	14.7	Generally not limiting design - verify by calculation
3.5	11.0	11.1	11.1		11.1	11.1	11.1	
4.0	8.60	8.61	8.58		8.62	8.62	8.60	
4.5	6.74	6.74	6.74		6.75	6.75	6.75	
5.0	5.45	5.45	5.45		5.45	5.45	5.45	
5.5	4.40	4.40	4.40		4.40	4.40	4.40	
6.0	3.61	3.61	3.61		3.61	3.61	3.61	
6.5	3.08	3.08	3.08		3.08	3.08	3.08	
7.0	2.65	2.65	2.65		2.65	2.65	2.65	
7.5	2.31	2.31	2.31		2.32	2.31	2.31	
8.0	2.03	2.03	2.03		2.01	2.03	2.03	
8.5	1.80	1.80	1.80		1.74	1.80	1.80	
9.0	1.61	1.61	1.61		1.52	1.61	1.61	
9.5	1.45	1.44	1.44		1.33	1.44	1.44	
10.0	1.30	1.30	1.30		1.17	1.30	1.30	
10.5	1.17	1.18	1.18		0.99	1.16	1.18	
11.0	1.06	1.07	1.07		0.93	1.04	1.08	
11.5	0.96	0.98	0.98		0.86	0.93	0.98	
12.0	0.87	0.90	0.90	0.79	0.84	0.90		
12.5	0.80	0.83	0.83	0.72	0.76	0.83		
13.0	0.73	0.77	0.77	0.65	0.68	0.75		
13.5	0.67	0.72	0.71	0.58	0.62	0.69		
14.0	0.62	0.67	0.66	0.52	0.55	0.63		
14.5	0.57	0.62	0.62	0.47	0.45	0.58		
15.0	0.53	0.57	0.58	0.42	0.36	0.53		
15.5								
16.0								
16.5								
17.0								
17.5								
18.0								

MSS 200/15								
SPAN (m)	INWARDS			Ws kN/m	OUTWARDS			Ws kN/m
	$\phi_b w_u$ kN/m				$\phi_b w_u$ kN/m			
	1B	2B	3B		1B	2B	3B	
3.0	23.5	23.5	23.5	Generally not limiting design - verify by calculation	23.6	23.6	23.6	Generally not limiting design - verify by calculation
3.5	17.2	17.2	17.2		17.3	17.3	17.3	
4.0	12.6	12.6	12.6		12.6	12.6	12.6	
4.5	9.50	9.50	9.50		9.50	9.50	9.50	
5.0	7.52	7.52	7.52		7.52	7.52	7.52	
5.5	6.07	6.07	6.07		6.07	6.07	6.07	
6.0	4.98	4.98	4.98		4.98	4.98	4.98	
6.5	4.25	4.25	4.25		4.25	4.25	4.25	
7.0	3.66	3.66	3.66		3.66	3.66	3.66	
7.5	3.19	3.19	3.19		3.19	3.19	3.19	
8.0	2.80	2.80	2.80		2.80	2.80	2.80	
8.5	2.48	2.48	2.48		2.48	2.48	2.48	
9.0	2.21	2.21	2.21		2.23	2.21	2.21	
9.5	1.99	1.99	1.99		1.96	1.99	1.99	
10.0	1.79	1.79	1.79		1.79	1.79	1.79	
10.5	1.63	1.63	1.63		1.61	1.63	1.63	
11.0	1.48	1.48	1.48		1.45	1.48	1.48	
11.5	1.36	1.36	1.36		1.30	1.36	1.36	
12.0	1.26	1.24	1.24	1.16	1.24	1.24		
12.5	1.15	1.15	1.15	1.04	1.12	1.15		
13.0	1.06	1.06	1.06	0.93	1.01	1.06		
13.5	0.97	0.98	0.98	0.83	0.95	0.98		
14.0	0.89	0.91	0.91	0.74	0.89	0.92		
14.5	0.82	0.85	0.85	0.66	0.82	0.85		
15.0	0.76	0.80	0.80	0.59	0.76	0.79		
15.5								
16.0								
16.5								
17.0								
17.5								
18.0								

- 1B = One mid span brace
- 2B = Two equally spaced braces within the span
- 3B = Three equally spaced braces within the span
- w_s = Uniformly distributed serviceability load (kN/m) for deflection limit of Span/150
- $\phi_b w_u$ = Strength load resistance applied at the centroid (kN/m)

- 2-M12 Grade 4.6 bolts per connection
- 2-M12 Grade 8.8 bolts per connection
- 2-M16 Grade 4.6 bolts per connection
- 2-M16 Grade 8.8 bolts per connection

IMPORTANT

The adequacy of multispan system is very sensitive to actual applied loads. The stated loads in this table are assumed uniform over the full purlin system. Variations in actual project design loadings over the length of the purlin system must be checked specifically by the designer to verify system adequacy.

LAPPED MULTISPAN (INTERNAL SPANS)

LOAD TABLE – Uniformly Distributed Load

MSS 200/18								
SPAN (m)	INWARDS			Ws kN/m	OUTWARDS			Ws kN/m
	$\phi_b w_u$ kN/m				$\phi_b w_u$ kN/m			
	1B	2B	3B		1B	2B	3B	
3.0	30.9	30.9	30.9	Generally not limiting design - verify by calculation	31.0	31.0	31.0	Generally not limiting design - verify by calculation
3.5	20.9	20.9	20.9		21.0	21.0	21.0	
4.0	15.3	15.3	15.3		15.3	15.3	15.3	
4.5	11.5	11.5	11.5		11.5	11.5	11.5	
5.0	9.07	9.07	9.07		9.07	9.07	9.07	
5.5	7.33	7.33	7.33		7.33	7.33	7.33	
6.0	6.02	6.02	6.02		6.01	6.01	6.01	
6.5	5.12	5.12	5.12		5.12	5.12	5.12	
7.0	4.41	4.41	4.41		4.41	4.41	4.41	
7.5	3.85	3.85	3.85		3.85	3.85	3.85	
8.0	3.38	3.38	3.38		3.38	3.38	3.38	
8.5	3.00	3.00	3.00		3.00	3.00	3.00	
9.0	2.67	2.67	2.67		2.67	2.67	2.67	
9.5	2.40	2.40	2.40		2.40	2.40	2.40	
10.0	2.16	2.16	2.16		2.07	2.16	2.16	
10.5	1.96	1.96	1.96		1.94	1.96	1.96	
11.0	1.79	1.79	1.79		1.76	1.79	1.79	
11.5	1.65	1.64	1.64		1.59	1.64	1.64	
12.0	1.51	1.50	1.50	1.41	1.50	1.50		
12.5	1.38	1.39	1.39	1.25	1.36	1.39		
13.0	1.26	1.28	1.28	1.12	1.22	1.28		
13.5	1.15	1.19	1.19	1.00	1.08	1.19		
14.0	1.06	1.11	1.11	0.89	1.01	1.11		
14.5	0.97	1.03	1.03	0.80	0.98	1.03		
15.0	0.90	0.96	0.96	0.72	0.92	0.96		
15.5								
16.0								
16.5								
17.0								
17.5								
18.0								

MSS 200/23								
SPAN (m)	INWARDS			Ws kN/m	OUTWARDS			Ws kN/m
	$\phi_b w_u$ kN/m				$\phi_b w_u$ kN/m			
	1B	2B	3B		1B	2B	3B	
3.0	39.6	39.6	39.6	Generally not limiting design - verify by calculation	39.9	39.9	39.9	Generally not limiting design - verify by calculation
3.5	29.3	29.3	29.3		29.3	29.3	29.3	
4.0	21.3	21.3	21.3		21.3	21.3	21.3	
4.5	16.0	16.0	16.0		16.0	16.0	16.0	
5.0	12.7	12.7	12.7		12.7	12.7	12.7	
5.5	10.2	10.2	10.2		10.2	10.2	10.2	
6.0	8.40	8.40	8.40		8.40	8.40	8.40	
6.5	7.16	7.16	7.16		7.16	7.16	7.16	
7.0	6.17	6.17	6.17		6.17	6.17	6.17	
7.5	5.36	5.37	5.37		5.39	5.37	5.37	
8.0	4.67	4.72	4.72		4.68	4.72	4.72	
8.5	4.11	4.18	4.18		4.09	4.18	4.18	
9.0	3.63	3.73	3.73		3.58	3.73	3.73	
9.5	3.23	3.35	3.35		3.16	3.35	3.35	
10.0	2.89	3.02	3.02		2.89	3.02	3.02	
10.5	2.60	2.74	2.74		2.58	2.71	2.74	
11.0	2.35	2.50	2.50		2.32	2.44	2.50	
11.5	2.14	2.29	2.29		2.08	2.20	2.29	
12.0	1.94	2.10	2.10	1.85	1.99	2.10		
12.5	1.76	1.93	1.93	1.65	1.80	1.93		
13.0	1.61	1.79	1.79	1.47	1.57	1.77		
13.5	1.47	1.65	1.66	1.31	1.44	1.62		
14.0	1.35	1.53	1.54	1.17	1.43	1.49		
14.5	1.24	1.42	1.44	1.04	1.33	1.37		
15.0	1.14	1.32	1.34	0.94	1.23	1.26		
15.5								
16.0								
16.5								
17.0								
17.5								
18.0								

- 1B = One mid span brace
- 2B = Two equally spaced braces within the span
- 3B = Three equally spaced braces within the span
- w_s = Uniformly distributed serviceability load (kN/m) for deflection limit of Span/150
- $\phi_b w_u$ = Strength load resistance applied at the centroid (kN/m)

- 2-M12 Grade 4.6 bolts per connection
- 2-M12 Grade 8.8 bolts per connection
- 2-M16 Grade 4.6 bolts per connection
- 2-M16 Grade 8.8 bolts per connection

IMPORTANT

The adequacy of multispan system is very sensitive to actual applied loads. The stated loads in this table are assumed uniform over the full purlin system. Variations in actual project design loadings over the length of the purlin system must be checked specifically by the designer to verify system adequacy.

LAPPED MULTISPAN (INTERNAL SPANS)

LOAD TABLE – Uniformly Distributed Load

MSS 250/13								
SPAN (m)	INWARDS			Ws kN/m	OUTWARDS			Ws kN/m
	$\phi_b w_u$ kN/m				$\phi_b w_u$ kN/m			
	1B	2B	3B		1B	2B	3B	
3.0								
3.5								
4.0	11.4	11.4	11.4		11.4	11.4	11.4	
4.5	9.17	9.15	9.14		9.17	9.15	9.15	
5.0	7.66	7.66	7.67		7.68	7.68	7.68	
5.5	6.43	6.43	6.41		6.45	6.44	6.43	
6.0	5.41	5.41	5.41		5.43	5.43	5.43	
6.5	4.70	4.69	4.69		4.70	4.70	4.70	
7.0	4.10	4.09	4.09		4.10	4.10	4.10	
7.5	3.58	3.60	3.61		3.60	3.61	3.61	
8.0	3.12	3.18	3.19		3.12	3.18	3.18	
8.5	2.75	2.82	2.82		2.73	2.82	2.82	
9.0	2.43	2.51	2.51		2.39	2.51	2.51	
9.5	2.17	2.26	2.26		2.11	2.26	2.26	
10.0	1.94	2.04	2.04		1.87	2.01	2.04	
10.5	1.75	1.85	1.85		1.66	1.81	1.85	
11.0	1.58	1.69	1.69		1.49	1.63	1.68	
11.5	1.44	1.54	1.54		1.33	1.47	1.54	
12.0	1.31	1.42	1.42		1.20	1.33	1.41	
12.5	1.20	1.30	1.31		1.10	1.21	1.29	
13.0	1.10	1.20	1.21		1.00	1.10	1.18	
13.5	1.01	1.10	1.12		0.92	1.00	1.08	
14.0	0.93	1.02	1.04		0.84	0.92	1.00	
14.5	0.86	0.94	0.97		0.77	0.84	0.92	
15.0	0.80	0.88	0.91		0.71	0.77	0.85	
15.5	0.74	0.82	0.85		0.66	0.70	0.78	
16.0	0.69	0.76	0.80		0.60	0.65	0.73	
16.5	0.64	0.71	0.74		0.55	0.58	0.67	
17.0	0.60	0.66	0.70		0.50	0.48	0.63	
17.5								
18.0								

Generally not limiting design - verify by calculation

Generally not limiting design - verify by calculation

MSS 250/15								
SPAN (m)	INWARDS			Ws kN/m	OUTWARDS			Ws kN/m
	$\phi_b w_u$ kN/m				$\phi_b w_u$ kN/m			
	1B	2B	3B		1B	2B	3B	
3.0								
3.5								
4.0	15.4	15.5	15.5		15.5	15.5	15.5	
4.5	12.3	12.3	12.3		12.3	12.3	12.3	
5.0	10.1	10.1	10.1		10.1	10.1	10.1	
5.5	8.35	8.35	8.35		8.38	8.38	8.37	
6.0	6.96	6.96	6.96		6.96	6.96	6.96	
6.5	5.93	5.93	5.93		5.93	5.93	5.93	
7.0	5.12	5.12	5.12		5.11	5.11	5.11	
7.5	4.45	4.45	4.45		4.45	4.45	4.45	
8.0	3.92	3.91	3.91		3.94	3.91	3.91	
8.5	3.44	3.47	3.47		3.44	3.47	3.47	
9.0	3.04	3.09	3.09		3.02	3.09	3.09	
9.5	2.70	2.77	2.77		2.66	2.78	2.77	
10.0	2.42	2.50	2.50		2.36	2.50	2.50	
10.5	2.18	2.27	2.27		2.10	2.27	2.27	
11.0	1.97	2.07	2.07		1.88	2.05	2.07	
11.5	1.79	1.89	1.89		1.68	1.85	1.89	
12.0	1.63	1.74	1.74		1.52	1.68	1.74	
12.5	1.49	1.60	1.60		1.37	1.53	1.60	
13.0	1.37	1.48	1.48		1.27	1.39	1.48	
13.5	1.25	1.38	1.38		1.17	1.27	1.37	
14.0	1.16	1.28	1.28		1.08	1.16	1.26	
14.5	1.07	1.19	1.19		0.99	1.06	1.16	
15.0	0.99	1.10	1.11		0.91	0.97	1.07	
15.5	0.92	1.02	1.04		0.83	0.89	0.99	
16.0	0.85	0.95	0.98		0.75	0.82	0.92	
16.5	0.80	0.89	0.92		0.69	0.74	0.85	
17.0	0.74	0.83	0.87		0.63	0.62	0.79	
17.5								
18.0								

Generally not limiting design - verify by calculation

Generally not limiting design - verify by calculation

- 1B = One mid span brace
- 2B = Two equally spaced braces within the span
- 3B = Three equally spaced braces within the span
- w_s = Uniformly distributed serviceability load (kN/m) for deflection limit of Span/150
- $\phi_b w_u$ = Strength load resistance applied at the centroid (kN/m)

- 2-M12 Grade 4.6 bolts per connection
- 2-M12 Grade 8.8 bolts per connection
- 2-M16 Grade 4.6 bolts per connection
- 2-M16 Grade 8.8 bolts per connection

IMPORTANT

The adequacy of multispan system is very sensitive to actual applied loads. The stated loads in this table are assumed uniform over the full purlin system. Variations in actual project design loadings over the length of the purlin system must be checked specifically by the designer to verify system adequacy.

LAPPED MULTISPAN (INTERNAL SPANS)

LOAD TABLE – Uniformly Distributed Load

MSS 250/18						
SPAN (m)	INWARDS			OUTWARDS		
	$\phi_b w_u$ kN/m			$\phi_b w_u$ kN/m		
	1B	2B	3B	1B	2B	3B
3.0						
3.5						
4.0	21.2	21.2	21.2	21.3	21.3	21.2
4.5	16.1	16.1	16.1	16.1	16.1	16.1
5.0	12.7	12.7	12.7	12.7	12.7	12.7
5.5	10.3	10.3	10.3	10.3	10.3	10.3
6.0	8.45	8.45	8.45	8.44	8.44	8.44
6.5	7.20	7.20	7.20	7.19	7.19	7.19
7.0	6.20	6.20	6.20	6.20	6.20	6.20
7.5	5.40	5.40	5.40	5.40	5.40	5.40
8.0	4.75	4.75	4.75	4.75	4.75	4.75
8.5	4.21	4.21	4.21	4.21	4.21	4.21
9.0	3.75	3.75	3.75	3.75	3.75	3.75
9.5	3.37	3.37	3.37	3.37	3.37	3.37
10.0	3.04	3.04	3.04	3.06	3.04	3.04
10.5	2.76	2.76	2.76	2.73	2.76	2.76
11.0	2.52	2.51	2.51	2.45	2.51	2.51
11.5	2.28	2.30	2.30	2.20	2.30	2.30
12.0	2.08	2.11	2.11	2.04	2.11	2.11
12.5	1.90	1.95	1.95	1.86	1.95	1.95
13.0	1.75	1.80	1.80	1.70	1.80	1.80
13.5	1.61	1.67	1.67	1.56	1.65	1.67
14.0	1.48	1.55	1.55	1.43	1.51	1.55
14.5	1.37	1.45	1.45	1.30	1.39	1.45
15.0	1.27	1.35	1.35	1.18	1.28	1.35
15.5	1.18	1.26	1.26	1.08	1.18	1.27
16.0	1.10	1.19	1.19	0.98	1.08	1.19
16.5	1.03	1.12	1.12	0.89	1.06	1.11
17.0	0.96	1.05	1.05	0.81	0.98	1.03
17.5						
18.0						

Generally not limiting design - verify by calculation

Generally not limiting design - verify by calculation

MSS 250/23						
SPAN (m)	INWARDS			OUTWARDS		
	$\phi_b w_u$ kN/m			$\phi_b w_u$ kN/m		
	1B	2B	3B	1B	2B	3B
3.0						
3.5						
4.0	28.8	28.8	28.8	29.7	29.7	29.7
4.5	22.6	22.6	22.6	22.6	22.6	22.6
5.0	17.9	17.9	17.9	17.9	17.9	17.9
5.5	14.4	14.4	14.4	14.4	14.4	14.4
6.0	11.8	11.8	11.8	11.8	11.8	11.8
6.5	10.1	10.1	10.1	10.1	10.1	10.1
7.0	8.70	8.70	8.70	8.70	8.70	8.70
7.5	7.58	7.58	7.58	7.57	7.57	7.57
8.0	6.65	6.65	6.65	6.65	6.65	6.65
8.5	5.90	5.90	5.90	5.90	5.90	5.90
9.0	5.26	5.26	5.26	5.26	5.26	5.26
9.5	4.73	4.73	4.73	4.72	4.72	4.72
10.0	4.26	4.27	4.27	4.27	4.26	4.26
10.5	3.88	3.87	3.87	3.92	3.86	3.86
11.0	3.49	3.52	3.52	3.52	3.52	3.52
11.5	3.15	3.22	3.22	3.19	3.22	3.22
12.0	2.86	2.96	2.96	2.90	2.96	2.96
12.5	2.61	2.72	2.72	2.65	2.73	2.72
13.0	2.38	2.52	2.52	2.41	2.52	2.52
13.5	2.18	2.34	2.34	2.17	2.34	2.34
14.0	2.00	2.17	2.17	1.96	2.14	2.17
14.5	1.84	2.03	2.03	1.77	1.96	2.03
15.0	1.70	1.89	1.89	1.61	1.79	1.89
15.5	1.57	1.77	1.77	1.46	1.62	1.77
16.0	1.45	1.67	1.67	1.32	1.59	1.67
16.5	1.35	1.56	1.56	1.20	1.49	1.56
17.0	1.25	1.48	1.48	1.09	1.40	1.46
17.5						
18.0						

Generally not limiting design - verify by calculation

Generally not limiting design - verify by calculation

- 1B = One mid span brace
- 2B = Two equally spaced braces within the span
- 3B = Three equally spaced braces within the span
- w_s = Uniformly distributed serviceability load (kN/m) for deflection limit of Span/150
- $\phi_b w_u$ = Strength load resistance applied at the centroid (kN/m)

- 2-M12 Grade 4.6 bolts per connection
- 2-M12 Grade 8.8 bolts per connection
- 2-M16 Grade 4.6 bolts per connection
- 2-M16 Grade 8.8 bolts per connection

IMPORTANT

The adequacy of multispan system is very sensitive to actual applied loads. The stated loads in this table are assumed uniform over the full purlin system. Variations in actual project design loadings over the length of the purlin system must be checked specifically by the designer to verify system adequacy.

LAPPED MULTISPAN (INTERNAL SPANS)

LOAD TABLE – Uniformly Distributed Load

MSS 275/15								
SPAN (m)	INWARDS			Ws kN/m	OUTWARDS			Ws kN/m
	$\phi_b w_u$ kN/m				$\phi_b w_u$ kN/m			
	1B	2B	3B		1B	2B	3B	
3.0								
3.5								
4.0								
4.5	11.4	11.4	11.4		11.4	11.4	11.4	
5.0	9.62	9.62	9.62		9.66	9.66	9.66	
5.5	8.14	8.13	8.11		8.20	8.18	8.18	
6.0	6.96	6.95	6.96		7.03	7.02	7.03	
6.5	6.13	6.13	6.13		6.22	6.22	6.22	
7.0	5.43	5.43	5.43		5.54	5.54	5.53	
7.5	4.82	4.81	4.82		4.91	4.91	4.91	
8.0	4.31	4.29	4.29		4.37	4.37	4.37	
8.5	3.82	3.88	3.88		3.87	3.88	3.88	
9.0	3.38	3.46	3.46		3.40	3.46	3.46	
9.5	3.01	3.10	3.10		3.01	3.11	3.11	
10.0	2.69	2.80	2.80		2.67	2.80	2.80	
10.5	2.42	2.54	2.54		2.37	2.54	2.54	
11.0	2.19	2.31	2.31		2.13	2.31	2.32	
11.5	1.99	2.12	2.12		1.91	2.09	2.12	
12.0	1.81	1.94	1.94		1.72	1.89	1.95	
12.5	1.65	1.79	1.79		1.54	1.72	1.79	
13.0	1.52	1.66	1.66		1.41	1.57	1.66	
13.5	1.40	1.54	1.54		1.31	1.44	1.54	
14.0	1.29	1.43	1.43		1.20	1.31	1.41	
14.5	1.19	1.33	1.33		1.10	1.20	1.31	
15.0	1.10	1.23	1.24		1.02	1.11	1.21	
15.5	1.03	1.15	1.17		0.95	1.02	1.12	
16.0	0.95	1.07	1.09		0.87	0.94	1.04	
16.5	0.89	1.00	1.03		0.80	0.86	0.96	
17.0	0.83	0.94	0.97		0.73	0.78	0.90	
17.5								
18.0								

MSS 275/18								
SPAN (m)	INWARDS			Ws kN/m	OUTWARDS			Ws kN/m
	$\phi_b w_u$ kN/m				$\phi_b w_u$ kN/m			
	1B	2B	3B		1B	2B	3B	
3.0								
3.5								
4.0								
4.5	16.2	16.2	16.2		16.4	16.4	16.4	
5.0	13.5	13.5	13.5		13.7	13.7	13.7	
5.5	11.3	11.3	11.3		11.5	11.5	11.5	
6.0	9.46	9.46	9.46		9.47	9.47	9.47	
6.5	8.06	8.06	8.06		8.07	8.07	8.07	
7.0	6.95	6.95	6.95		6.96	6.96	6.96	
7.5	6.05	6.05	6.05		6.06	6.06	6.06	
8.0	5.32	5.32	5.32		5.33	5.33	5.33	
8.5	4.71	4.71	4.71		4.72	4.72	4.72	
9.0	4.20	4.20	4.20		4.21	4.21	4.21	
9.5	3.77	3.77	3.77		3.78	3.78	3.78	
10.0	3.40	3.41	3.41		3.43	3.41	3.41	
10.5	3.08	3.09	3.09		3.08	3.09	3.09	
11.0	2.79	2.82	2.82		2.76	2.82	2.82	
11.5	2.53	2.57	2.57		2.48	2.58	2.58	
12.0	2.31	2.36	2.36		2.24	2.37	2.37	
12.5	2.11	2.18	2.18		2.03	2.18	2.18	
13.0	1.94	2.02	2.02		1.89	2.02	2.02	
13.5	1.78	1.87	1.87		1.73	1.86	1.87	
14.0	1.64	1.74	1.74		1.60	1.71	1.74	
14.5	1.52	1.62	1.62		1.48	1.57	1.62	
15.0	1.41	1.51	1.51		1.36	1.44	1.52	
15.5	1.31	1.42	1.42		1.24	1.33	1.42	
16.0	1.22	1.33	1.33		1.13	1.23	1.33	
16.5	1.14	1.25	1.25		1.04	1.14	1.25	
17.0	1.06	1.18	1.18		0.95	1.05	1.16	
17.5								
18.0								

- 1B = One mid span brace
- 2B = Two equally spaced braces within the span
- 3B = Three equally spaced braces within the span
- w_s = Uniformly distributed serviceability load (kN/m) for deflection limit of Span/150
- $\phi_b w_u$ = Strength load resistance applied at the centroid (kN/m)

- 2-M12 Grade 4.6 bolts per connection
- 2-M12 Grade 8.8 bolts per connection
- 2-M16 Grade 4.6 bolts per connection
- 2-M16 Grade 8.8 bolts per connection

IMPORTANT

The adequacy of multispan system is very sensitive to actual applied loads. The stated loads in this table are assumed uniform over the full purlin system. Variations in actual project design loadings over the length of the purlin system must be checked specifically by the designer to verify system adequacy.

LAPPED MULTISPAN (INTERNAL SPANS)

LOAD TABLE – Uniformly Distributed Load

MSS 300/15						
SPAN (m)	INWARDS			OUTWARDS		
	$\phi_b w_u$ kN/m			$\phi_b w_u$ kN/m		
	1B	2B	3B	1B	2B	3B
3.0						
3.5						
4.0						
4.5						
5.0	9.47	9.46	9.48	9.47	9.46	9.47
5.5	8.13	8.11	8.11	8.13	8.11	8.11
6.0	7.04	7.04	7.05	7.04	7.04	7.05
6.5	6.27	6.27	6.27	6.27	6.27	6.27
7.0	5.62	5.62	5.62	5.62	5.62	5.62
7.5	5.07	5.06	5.06	5.07	5.06	5.06
8.0	4.59	4.59	4.59	4.59	4.59	4.59
8.5	4.18	4.18	4.18	4.18	4.18	4.18
9.0	3.82	3.82	3.82	3.82	3.82	3.82
9.5	3.47	3.47	3.47	3.47	3.47	3.47
10.0	3.14	3.17	3.17	3.18	3.17	3.17
10.5	2.82	2.89	2.89	2.84	2.89	2.89
11.0	2.55	2.66	2.66	2.55	2.66	2.66
11.5	2.32	2.45	2.45	2.30	2.45	2.45
12.0	2.11	2.25	2.25	2.07	2.24	2.25
12.5	1.93	2.07	2.07	1.88	2.05	2.07
13.0	1.77	1.92	1.92	1.71	1.88	1.92
13.5	1.63	1.78	1.78	1.56	1.72	1.78
14.0	1.50	1.65	1.65	1.42	1.58	1.65
14.5	1.39	1.54	1.54	1.33	1.45	1.54
15.0	1.29	1.44	1.44	1.23	1.34	1.43
15.5	1.20	1.34	1.35	1.14	1.24	1.33
16.0	1.11	1.25	1.27	1.05	1.14	1.24
16.5	1.04	1.17	1.19	0.98	1.06	1.15
17.0	0.97	1.10	1.12	0.91	0.98	1.08
17.5	0.91	1.03	1.06	0.85	0.91	1.01
18.0	0.85	0.97	1.00	0.78	0.84	0.94

Generally not limiting design - verify by calculation

Generally not limiting design - verify by calculation

MSS 300/18						
SPAN (m)	INWARDS			OUTWARDS		
	$\phi_b w_u$ kN/m			$\phi_b w_u$ kN/m		
	1B	2B	3B	1B	2B	3B
3.0						
3.5						
4.0						
4.5						
5.0	13.8	13.8	13.8	13.8	13.8	13.8
5.5	11.7	11.7	11.7	11.7	11.7	11.7
6.0	10.0	10.0	10.0	10.0	10.0	10.0
6.5	8.89	8.89	8.89	8.89	8.89	8.89
7.0	7.93	7.93	7.93	7.93	7.93	7.93
7.5	7.02	7.01	7.02	7.02	7.01	7.02
8.0	6.17	6.17	6.17	6.17	6.17	6.17
8.5	5.46	5.46	5.46	5.46	5.46	5.46
9.0	4.88	4.88	4.88	4.88	4.88	4.88
9.5	4.37	4.37	4.37	4.37	4.37	4.37
10.0	3.95	3.95	3.95	3.95	3.95	3.95
10.5	3.58	3.58	3.58	3.58	3.58	3.58
11.0	3.24	3.26	3.26	3.28	3.26	3.26
11.5	2.94	2.99	2.99	2.96	2.99	2.99
12.0	2.68	2.74	2.74	2.68	2.74	2.74
12.5	2.45	2.53	2.53	2.43	2.53	2.53
13.0	2.25	2.34	2.34	2.22	2.34	2.34
13.5	2.06	2.17	2.17	2.02	2.17	2.17
14.0	1.90	2.01	2.01	1.86	2.01	2.01
14.5	1.76	1.88	1.88	1.69	1.87	1.88
15.0	1.63	1.76	1.76	1.59	1.73	1.76
15.5	1.52	1.64	1.64	1.48	1.60	1.64
16.0	1.41	1.54	1.54	1.38	1.48	1.54
16.5	1.32	1.45	1.45	1.29	1.38	1.45
17.0	1.23	1.37	1.37	1.20	1.28	1.37
17.5	1.15	1.29	1.29	1.11	1.19	1.29
18.0	1.08	1.22	1.22	1.02	1.11	1.21

Generally not limiting design - verify by calculation

Generally not limiting design - verify by calculation

- 1B = One mid span brace
- 2B = Two equally spaced braces within the span
- 3B = Three equally spaced braces within the span
- w_s = Uniformly distributed serviceability load (kN/m) for deflection limit of Span/150
- $\phi_b w_u$ = Strength load resistance applied at the centroid (kN/m)

- 2-M12 Grade 4.6 bolts per connection
- 2-M12 Grade 8.8 bolts per connection
- 2-M16 Grade 4.6 bolts per connection
- 2-M16 Grade 8.8 bolts per connection

IMPORTANT

The adequacy of multispan system is very sensitive to actual applied loads. The stated loads in this table are assumed uniform over the full purlin system. Variations in actual project design loadings over the length of the purlin system must be checked specifically by the designer to verify system adequacy.

LAPPED MULTISPAN (INTERNAL SPANS)

LOAD TABLE – Uniformly Distributed Load

MSS 300/23								
SPAN (m)	INWARDS			Ws kN/m	OUTWARDS			Ws kN/m
	$\phi_b w_u$ kN/m				$\phi_b w_u$ kN/m			
	1B	2B	3B		1B	2B	3B	
3.0								
3.5								
4.0								
4.5								
5.0	23.4	23.4	23.4		23.4	23.4	23.4	
5.5	18.8	18.8	18.8		18.8	18.8	18.8	
6.0	15.5	15.5	15.5		15.5	15.5	15.5	
6.5	13.2	13.2	13.2		13.2	13.2	13.2	
7.0	11.4	11.4	11.4		11.4	11.4	11.4	
7.5	9.90	9.90	9.90		9.90	9.90	9.90	
8.0	8.71	8.71	8.71		8.71	8.71	8.71	
8.5	7.71	7.71	7.71		7.71	7.71	7.71	
9.0	6.88	6.88	6.88		6.88	6.88	6.88	
9.5	6.17	6.17	6.17		6.17	6.17	6.17	
10.0	5.57	5.57	5.57		5.57	5.57	5.57	
10.5	5.05	5.05	5.05		5.05	5.05	5.05	
11.0	4.60	4.60	4.60		4.60	4.60	4.60	
11.5	4.21	4.21	4.21		4.21	4.21	4.21	
12.0	3.87	3.87	3.87		3.87	3.87	3.87	
12.5	3.58	3.56	3.56		3.60	3.56	3.56	
13.0	3.27	3.29	3.29		3.37	3.29	3.29	
13.5	3.00	3.05	3.05		3.10	3.05	3.05	
14.0	2.75	2.84	2.84		2.85	2.84	2.84	
14.5	2.53	2.65	2.65		2.64	2.65	2.65	
15.0	2.34	2.48	2.48		2.44	2.48	2.48	
15.5	2.16	2.32	2.32		2.25	2.32	2.32	
16.0	2.00	2.17	2.17		2.06	2.18	2.17	
16.5	1.86	2.05	2.05		1.88	2.05	2.05	
17.0	1.73	1.93	1.93		1.72	1.91	1.93	
17.5	1.61	1.82	1.82		1.57	1.76	1.82	
18.0	1.50	1.72	1.72		1.44	1.63	1.72	

Generally not limiting design - verify by calculation

Generally not limiting design - verify by calculation

MSS 300/24								
SPAN (m)	INWARDS			Ws kN/m	OUTWARDS			Ws kN/m
	$\phi_b w_u$ kN/m				$\phi_b w_u$ kN/m			
	1B	2B	3B		1B	2B	3B	
3.0								
3.5								
4.0								
4.5								
5.0	23.9	23.9	23.9		24.0	24.0	24.0	
5.5	20.6	20.6	20.6		20.6	20.6	20.6	
6.0	16.9	16.9	16.9		16.9	16.9	16.9	
6.5	14.4	14.4	14.4		14.4	14.4	14.4	
7.0	12.4	12.4	12.4		12.4	12.4	12.4	
7.5	10.8	10.8	10.8		10.8	10.8	10.8	
8.0	9.52	9.52	9.52		9.52	9.52	9.52	
8.5	8.44	8.44	8.44		8.44	8.44	8.44	
9.0	7.53	7.53	7.53		7.53	7.53	7.53	
9.5	6.75	6.75	6.75		6.75	6.75	6.75	
10.0	6.09	6.09	6.09		6.09	6.09	6.09	
10.5	5.53	5.53	5.53		5.53	5.53	5.53	
11.0	5.03	5.04	5.04		5.03	5.04	5.04	
11.5	4.61	4.61	4.61		4.61	4.61	4.61	
12.0	4.22	4.23	4.23		4.24	4.23	4.23	
12.5	3.84	3.90	3.90		3.99	3.90	3.90	
13.0	3.50	3.61	3.61		3.63	3.61	3.61	
13.5	3.20	3.34	3.34		3.34	3.34	3.34	
14.0	2.94	3.11	3.11		3.08	3.11	3.11	
14.5	2.71	2.90	2.90		2.85	2.90	2.90	
15.0	2.50	2.71	2.71		2.64	2.71	2.71	
15.5	2.31	2.54	2.54		2.42	2.54	2.54	
16.0	2.14	2.38	2.38		2.21	2.38	2.38	
16.5	1.98	2.24	2.24		2.02	2.23	2.24	
17.0	1.84	2.11	2.11		1.85	2.07	2.11	
17.5	1.72	1.99	1.99		1.70	1.91	1.99	
18.0	1.60	1.88	1.88		1.56	1.76	1.88	

Generally not limiting design - verify by calculation

Generally not limiting design - verify by calculation

- 1B = One mid span brace
- 2B = Two equally spaced braces within the span
- 3B = Three equally spaced braces within the span
- w_s = Uniformly distributed serviceability load (kN/m) for deflection limit of Span/150
- $\phi_b w_u$ = Strength load resistance applied at the centroid (kN/m)

- 2-M12 Grade 4.6 bolts per connection
- 2-M12 Grade 8.8 bolts per connection
- 2-M16 Grade 4.6 bolts per connection
- 2-M16 Grade 8.8 bolts per connection

IMPORTANT

The adequacy of multispan system is very sensitive to actual applied loads. The stated loads in this table are assumed uniform over the full purlin system. Variations in actual project design loadings over the length of the purlin system must be checked specifically by the designer to verify system adequacy.

LAPPED MULTISPAN (INTERNAL SPANS)

LOAD TABLE – Uniformly Distributed Load

MSS 300/30								
SPAN (m)	INWARDS			Ws kN/m	OUTWARDS			Ws kN/m
	$\phi_b w_u$ kN/m				$\phi_b w_u$ kN/m			
	1B	2B	3B		1B	2B	3B	
3.0								
3.5								
4.0								
4.5								
5.0	23.3	23.3	23.3		23.3	23.3	23.3	
5.5	21.2	21.2	21.2		21.2	21.2	21.2	
6.0	20.0	20.0	20.0		20.1	20.1	20.1	
6.5	18.3	18.3	18.3		18.4	18.4	18.4	
7.0	16.4	16.4	16.4		16.4	16.4	16.4	
7.5	14.2	14.2	14.2		14.2	14.2	14.2	
8.0	12.5	12.5	12.5		12.5	12.5	12.5	
8.5	11.1	11.1	11.1		11.1	11.1	11.1	
9.0	9.89	9.89	9.89		9.89	9.89	9.89	
9.5	8.87	8.88	8.88		8.88	8.88	8.88	
10.0	8.01	8.01	8.01		8.01	8.01	8.01	
10.5	7.22	7.26	7.26		7.27	7.26	7.26	
11.0	6.46	6.62	6.62		6.62	6.62	6.62	
11.5	5.81	6.06	6.06		6.09	6.06	6.06	
12.0	5.24	5.56	5.56		5.71	5.56	5.56	
12.5	4.75	5.13	5.13		5.17	5.13	5.13	
13.0	4.31	4.74	4.74		4.68	4.74	4.74	
13.5	3.93	4.40	4.40		4.31	4.40	4.40	
14.0	3.59	4.09	4.09		3.98	4.09	4.09	
14.5	3.29	3.81	3.81		3.67	3.81	3.81	
15.0	3.02	3.56	3.56		3.35	3.56	3.56	
15.5	2.78	3.33	3.33		3.05	3.34	3.33	
16.0	2.57	3.13	3.13		2.78	3.09	3.13	
16.5	2.37	2.94	2.94		2.54	2.85	2.94	
17.0	2.20	2.77	2.77		2.32	2.61	2.77	
17.5	2.04	2.62	2.62		2.12	2.38	2.62	
18.0	1.89	2.47	2.47		1.94	2.31	2.47	

Generally not limiting design - verify by calculation

Generally not limiting design - verify by calculation

MSS 325/15								
SPAN (m)	INWARDS			Ws kN/m	OUTWARDS			Ws kN/m
	$\phi_b w_u$ kN/m				$\phi_b w_u$ kN/m			
	1B	2B	3B		1B	2B	3B	
3.0								
3.5								
4.0								
4.5								
5.0	9.57	9.56	9.57		9.59	9.58	9.58	
5.5	8.26	8.24	8.24		8.27	8.24	8.24	
6.0	7.19	7.19	7.20		7.19	7.19	7.20	
6.5	6.43	6.43	6.43		6.43	6.43	6.43	
7.0	5.78	5.78	5.78		5.78	5.77	5.77	
7.5	5.22	5.21	5.21		5.22	5.21	5.21	
8.0	4.75	4.75	4.75		4.75	4.75	4.75	
8.5	4.33	4.33	4.33		4.33	4.33	4.33	
9.0	3.96	3.96	3.96		3.97	3.97	3.97	
9.5	3.64	3.64	3.64		3.65	3.64	3.64	
10.0	3.35	3.36	3.36		3.36	3.37	3.36	
10.5	3.07	3.08	3.08		3.09	3.09	3.09	
11.0	2.77	2.84	2.84		2.78	2.84	2.84	
11.5	2.51	2.62	2.62		2.50	2.62	2.62	
12.0	2.29	2.42	2.42		2.26	2.42	2.43	
12.5	2.09	2.25	2.25		2.05	2.23	2.25	
13.0	1.92	2.08	2.08		1.86	2.04	2.08	
13.5	1.76	1.93	1.93		1.68	1.87	1.93	
14.0	1.62	1.80	1.79		1.55	1.72	1.79	
14.5	1.50	1.67	1.67		1.45	1.58	1.67	
15.0	1.39	1.56	1.56		1.34	1.46	1.56	
15.5	1.29	1.46	1.46		1.24	1.35	1.45	
16.0	1.20	1.36	1.37		1.15	1.24	1.35	
16.5	1.12	1.28	1.29		1.07	1.15	1.26	
17.0	1.05	1.19	1.22		0.99	1.06	1.17	
17.5	0.98	1.12	1.15		0.92	0.98	1.09	
18.0	0.92	1.05	1.09		0.85	0.91	1.02	

Generally not limiting design - verify by calculation

Generally not limiting design - verify by calculation

- 1B = One mid span brace
- 2B = Two equally spaced braces within the span
- 3B = Three equally spaced braces within the span
- w_s = Uniformly distributed serviceability load (kN/m) for deflection limit of Span/150
- $\phi_b w_u$ = Strength load resistance applied at the centroid (kN/m)

- 2-M12 Grade 4.6 bolts per connection
- 2-M12 Grade 8.8 bolts per connection
- 2-M16 Grade 4.6 bolts per connection
- 2-M16 Grade 8.8 bolts per connection

IMPORTANT

The adequacy of multispan system is very sensitive to actual applied loads. The stated loads in this table are assumed uniform over the full purlin system. Variations in actual project design loadings over the length of the purlin system must be checked specifically by the designer to verify system adequacy.

LAPPED MULTISPAN (INTERNAL SPANS)

LOAD TABLE – Uniformly Distributed Load

MSS 325/18								
SPAN (m)	INWARDS			Ws kN/m	OUTWARDS			Ws kN/m
	$\phi_b w_u$ kN/m				$\phi_b w_u$ kN/m			
	1B	2B	3B		1B	2B	3B	
3.0								
3.5								
4.0								
4.5								
5.0	14.0	14.0	14.0		14.0	14.0	14.0	
5.5	12.0	11.9	11.9		12.0	11.9	11.9	
6.0	10.3	10.3	10.3		10.3	10.3	10.3	
6.5	9.17	9.17	9.17		9.17	9.17	9.17	
7.0	8.19	8.19	8.19		8.20	8.20	8.19	
7.5	7.37	7.36	7.35		7.37	7.37	7.37	
8.0	6.68	6.68	6.68		6.69	6.69	6.69	
8.5	5.94	5.94	5.94		5.94	5.94	5.94	
9.0	5.30	5.30	5.30		5.30	5.30	5.30	
9.5	4.75	4.75	4.75		4.75	4.75	4.75	
10.0	4.29	4.29	4.29		4.29	4.29	4.29	
10.5	3.89	3.89	3.89		3.89	3.89	3.89	
11.0	3.51	3.54	3.54		3.56	3.54	3.54	
11.5	3.18	3.25	3.25		3.21	3.24	3.24	
12.0	2.90	2.98	2.98		2.91	2.98	2.98	
12.5	2.65	2.75	2.75		2.64	2.74	2.75	
13.0	2.43	2.54	2.54		2.40	2.54	2.54	
13.5	2.24	2.35	2.35		2.19	2.35	2.35	
14.0	2.06	2.19	2.19		2.00	2.19	2.19	
14.5	1.91	2.04	2.04		1.78	2.03	2.04	
15.0	1.77	1.91	1.91		1.71	1.88	1.91	
15.5	1.64	1.79	1.79		1.59	1.74	1.79	
16.0	1.53	1.67	1.67		1.48	1.61	1.68	
16.5	1.42	1.58	1.58		1.39	1.49	1.57	
17.0	1.33	1.48	1.48		1.30	1.38	1.48	
17.5	1.24	1.40	1.40		1.20	1.29	1.40	
18.0	1.17	1.33	1.32		1.11	1.20	1.32	

Generally not limiting design - verify by calculation

Generally not limiting design - verify by calculation

MSS 350/18								
SPAN (m)	INWARDS			Ws kN/m	OUTWARDS			Ws kN/m
	$\phi_b w_u$ kN/m				$\phi_b w_u$ kN/m			
	1B	2B	3B		1B	2B	3B	
3.0								
3.5								
4.0								
4.5								
5.0								
5.5								
6.0	9.68	9.68	9.69		9.66	9.66	9.67	
6.5	8.66	8.66	8.66		8.65	8.65	8.65	
7.0	7.78	7.78	7.78		7.78	7.78	7.78	
7.5	7.04	7.03	7.03		7.04	7.03	7.03	
8.0	6.40	6.40	6.40		6.41	6.41	6.41	
8.5	5.84	5.84	5.84		5.85	5.85	5.85	
9.0	5.35	5.35	5.35		5.36	5.36	5.36	
9.5	4.93	4.92	4.92		4.95	4.94	4.94	
10.0	4.54	4.54	4.54		4.57	4.56	4.56	
10.5	4.21	4.20	4.21		4.23	4.23	4.23	
11.0	3.88	3.88	3.88		3.91	3.90	3.90	
11.5	3.54	3.58	3.58		3.59	3.61	3.60	
12.0	3.22	3.32	3.32		3.26	3.33	3.33	
12.5	2.94	3.07	3.07		2.95	3.07	3.07	
13.0	2.69	2.84	2.84		2.69	2.84	2.84	
13.5	2.47	2.63	2.63		2.45	2.63	2.63	
14.0	2.28	2.45	2.45		2.24	2.45	2.45	
14.5	2.11	2.28	2.28		2.03	2.26	2.28	
15.0	1.95	2.13	2.13		1.91	2.10	2.13	
15.5	1.81	2.00	2.00		1.77	1.95	1.99	
16.0	1.68	1.87	1.87		1.64	1.80	1.87	
16.5	1.57	1.76	1.76		1.53	1.67	1.76	
17.0	1.46	1.66	1.66		1.42	1.55	1.66	
17.5	1.37	1.57	1.57		1.33	1.44	1.56	
18.0	1.28	1.48	1.48		1.24	1.34	1.47	

Generally not limiting design - verify by calculation

Generally not limiting design - verify by calculation

- 1B = One mid span brace
- 2B = Two equally spaced braces within the span
- 3B = Three equally spaced braces within the span
- w_s = Uniformly distributed serviceability load (kN/m) for deflection limit of Span/150
- $\phi_b w_u$ = Strength load resistance applied at the centroid (kN/m)

- 2-M12 Grade 4.6 bolts per connection
- 2-M12 Grade 8.8 bolts per connection
- 2-M16 Grade 4.6 bolts per connection
- 2-M16 Grade 8.8 bolts per connection

IMPORTANT

The adequacy of multispan system is very sensitive to actual applied loads. The stated loads in this table are assumed uniform over the full purlin system. Variations in actual project design loadings over the length of the purlin system must be checked specifically by the designer to verify system adequacy.

LAPPED MULTISPAN (INTERNAL SPANS)

LOAD TABLE – Uniformly Distributed Load

MSS 350/23								
SPAN (m)	INWARDS			Ws kN/m	OUTWARDS			Ws kN/m
	$\phi_b w_u$ kN/m				$\phi_b w_u$ kN/m			
	1B	2B	3B		1B	2B	3B	
3.0								
3.5								
4.0								
4.5								
5.0								
5.5								
6.0	16.5	16.5	16.5		16.5	16.5	16.5	
6.5	14.7	14.7	14.7		14.7	14.7	14.7	
7.0	13.1	13.1	13.1		13.1	13.1	13.1	
7.5	12.0	12.0	12.0		12.0	12.0	12.0	
8.0	10.6	10.6	10.6		10.6	10.6	10.6	
8.5	9.38	9.38	9.38		9.38	9.38	9.38	
9.0	8.37	8.37	8.37		8.37	8.37	8.37	
9.5	7.51	7.51	7.51		7.51	7.51	7.51	
10.0	6.78	6.78	6.78		6.78	6.78	6.78	
10.5	6.14	6.14	6.14		6.14	6.14	6.14	
11.0	5.60	5.60	5.60		5.60	5.60	5.60	
11.5	5.13	5.12	5.12		5.13	5.12	5.12	
12.0	4.67	4.70	4.70		4.71	4.70	4.70	
12.5	4.26	4.34	4.34		4.39	4.34	4.34	
13.0	3.90	4.01	4.01		4.01	4.01	4.01	
13.5	3.57	3.72	3.72		3.66	3.72	3.72	
14.0	3.29	3.46	3.46		3.34	3.46	3.46	
14.5	3.04	3.23	3.23		3.14	3.22	3.22	
15.0	2.81	3.01	3.01		2.91	3.01	3.01	
15.5	2.60	2.82	2.82		2.70	2.82	2.82	
16.0	2.41	2.65	2.65		2.51	2.65	2.65	
16.5	2.25	2.49	2.49		2.31	2.49	2.49	
17.0	2.09	2.35	2.35		2.13	2.31	2.35	
17.5	1.96	2.21	2.21		1.96	2.15	2.21	
18.0	1.83	2.09	2.09		1.81	2.00	2.09	

Generally not limiting design - verify by calculation

Generally not limiting design - verify by calculation

MSS 350/24								
SPAN (m)	INWARDS			Ws kN/m	OUTWARDS			Ws kN/m
	$\phi_b w_u$ kN/m				$\phi_b w_u$ kN/m			
	1B	2B	3B		1B	2B	3B	
3.0								
3.5								
4.0								
4.5								
5.0								
5.5								
6.0	18.8	18.8	18.8		18.8	18.8	18.8	
6.5	16.8	16.8	16.8		16.8	16.8	16.8	
7.0	15.1	15.1	15.1		15.1	15.1	15.1	
7.5	13.2	13.2	13.2		13.2	13.2	13.2	
8.0	11.6	11.6	11.6		11.6	11.6	11.6	
8.5	10.2	10.2	10.2		10.2	10.2	10.2	
9.0	9.14	9.14	9.14		9.14	9.14	9.14	
9.5	8.20	8.20	8.20		8.20	8.20	8.20	
10.0	7.39	7.39	7.39		7.39	7.39	7.39	
10.5	6.71	6.71	6.71		6.71	6.71	6.71	
11.0	6.12	6.12	6.12		6.11	6.12	6.12	
11.5	5.59	5.59	5.59		5.59	5.59	5.59	
12.0	5.15	5.14	5.14		5.14	5.14	5.14	
12.5	4.70	4.74	4.74		4.74	4.74	4.74	
13.0	4.30	4.38	4.38		4.45	4.38	4.38	
13.5	3.94	4.06	4.06		4.06	4.06	4.06	
14.0	3.62	3.78	3.78		3.81	3.78	3.78	
14.5	3.34	3.52	3.52		3.52	3.52	3.52	
15.0	3.09	3.29	3.29		3.26	3.29	3.29	
15.5	2.85	3.08	3.08		3.01	3.08	3.08	
16.0	2.64	2.89	2.89		2.77	2.89	2.89	
16.5	2.44	2.72	2.72		2.55	2.72	2.72	
17.0	2.27	2.56	2.56		2.34	2.57	2.56	
17.5	2.11	2.42	2.42		2.16	2.38	2.42	
18.0	1.97	2.29	2.29		1.98	2.22	2.29	

Generally not limiting design - verify by calculation

Generally not limiting design - verify by calculation

- 1B = One mid span brace
- 2B = Two equally spaced braces within the span
- 3B = Three equally spaced braces within the span
- w_s = Uniformly distributed serviceability load (kN/m) for deflection limit of Span/150
- $\phi_b w_u$ = Strength load resistance applied at the centroid (kN/m)

- 2-M12 Grade 4.6 bolts per connection
- 2-M12 Grade 8.8 bolts per connection
- 2-M16 Grade 4.6 bolts per connection
- 2-M16 Grade 8.8 bolts per connection

IMPORTANT

The adequacy of multispan system is very sensitive to actual applied loads. The stated loads in this table are assumed uniform over the full purlin system. Variations in actual project design loadings over the length of the purlin system must be checked specifically by the designer to verify system adequacy.

LAPPED MULTISPAN (INTERNAL SPANS)

LOAD TABLE – Uniformly Distributed Load

MSS 350/30										
SPAN (m)	INWARDS				OUTWARDS				Ws kN/m	Ws kN/m
	$\phi_b w_u$ kN/m			Ws kN/m	$\phi_b w_u$ kN/m			Ws kN/m		
	1B	2B	3B		1B	2B	3B			
3.0										
3.5										
4.0										
4.5										
5.0										
5.5										
6.0	19.4	19.4	19.4		19.4	19.4	19.4			
6.5	17.9	17.9	17.9		17.9	17.9	17.9			
7.0	17.2	17.2	17.2		17.2	17.2	17.2			
7.5	16.1	16.1	16.1		16.0	16.0	16.0			
8.0	14.9	14.9	14.9		14.9	14.9	14.9			
8.5	13.5	13.5	13.5		13.5	13.5	13.5			
9.0	12.1	12.1	12.1		12.1	12.1	12.1			
9.5	10.8	10.8	10.8		10.8	10.8	10.8			
10.0	9.77	9.77	9.77		9.77	9.77	9.77			
10.5	8.86	8.86	8.86		8.86	8.86	8.86			
11.0	8.03	8.07	8.07		8.08	8.07	8.07			
11.5	7.20	7.39	7.39		7.39	7.39	7.39			
12.0	6.49	6.79	6.79		6.79	6.79	6.79			
12.5	5.86	6.25	6.25		6.40	6.25	6.25			
13.0	5.32	5.78	5.78		5.86	5.78	5.78			
13.5	4.84	5.36	5.36		5.41	5.36	5.36			
14.0	4.42	4.98	4.98		5.00	4.98	4.98			
14.5	4.04	4.65	4.65		4.60	4.65	4.65			
15.0	3.70	4.34	4.34		4.24	4.34	4.34			
15.5	3.40	4.06	4.06		3.86	4.07	4.06			
16.0	3.13	3.81	3.81		3.52	3.81	3.81			
16.5	2.90	3.59	3.59		3.22	3.59	3.59			
17.0	2.67	3.38	3.38		2.94	3.30	3.38			
17.5	2.48	3.19	3.19		2.69	3.02	3.19			
18.0	2.30	3.02	3.02		2.47	2.70	3.02			

Generally not limiting design - verify by calculation

Generally not limiting design - verify by calculation

MSS 400/20										
SPAN (m)	INWARDS				OUTWARDS				Ws kN/m	Ws kN/m
	$\phi_b w_u$ kN/m			Ws kN/m	$\phi_b w_u$ kN/m			Ws kN/m		
	1B	2B	3B		1B	2B	3B			
3.0										
3.5										
4.0										
4.5										
5.0										
5.5										
6.0	10.8	10.8	10.8		10.8	10.8	10.8			
6.5	9.74	9.75	9.74		9.74	9.75	9.74			
7.0	8.84	8.84	8.83		8.84	8.84	8.83			
7.5	8.05	8.05	8.04		8.05	8.05	8.04			
8.0	7.38	7.38	7.38		7.38	7.38	7.38			
8.5	6.79	6.79	6.79		6.79	6.79	6.79			
9.0	6.26	6.26	6.26		6.26	6.26	6.26			
9.5	5.80	5.80	5.80		5.80	5.80	5.80			
10.0	5.39	5.38	5.37		5.39	5.38	5.37			
10.5	5.02	5.02	5.02		5.02	5.02	5.02			
11.0	4.68	4.69	4.69		4.68	4.68	4.68			
11.5	4.38	4.38	4.38		4.38	4.38	4.38			
12.0	4.11	4.11	4.11		4.11	4.11	4.10			
12.5	3.92	3.86	3.86		3.92	3.86	3.86			
13.0	3.61	3.64	3.64		3.65	3.64	3.64			
13.5	3.32	3.43	3.43		3.35	3.43	3.43			
14.0	3.06	3.24	3.24		3.07	3.24	3.24			
14.5	2.83	3.06	3.05		2.84	3.06	3.06			
15.0	2.62	2.88	2.88		2.65	2.85	2.88			
15.5	2.44	2.70	2.70		2.46	2.64	2.70			
16.0	2.27	2.53	2.53		2.28	2.46	2.53			
16.5	2.11	2.38	2.38		2.12	2.28	2.38			
17.0	1.97	2.24	2.24		1.97	2.12	2.25			
17.5	1.83	2.13	2.12		1.84	1.98	2.12			
18.0	1.71	2.00	2.00		1.72	1.84	2.00			

Generally not limiting design - verify by calculation

Generally not limiting design - verify by calculation

- 1B = One mid span brace
- 2B = Two equally spaced braces within the span
- 3B = Three equally spaced braces within the span
- w_s = Uniformly distributed serviceability load (kN/m) for deflection limit of Span/150
- $\phi_b w_u$ = Strength load resistance applied at the centroid (kN/m)

- 2-M12 Grade 4.6 bolts per connection
- 2-M12 Grade 8.8 bolts per connection
- 2-M16 Grade 4.6 bolts per connection
- 2-M16 Grade 8.8 bolts per connection

IMPORTANT

The adequacy of multispan system is very sensitive to actual applied loads. The stated loads in this table are assumed uniform over the full purlin system. Variations in actual project design loadings over the length of the purlin system must be checked specifically by the designer to verify system adequacy.

LAPPED MULTISPAN (INTERNAL SPANS)

LOAD TABLE – Uniformly Distributed Load

MSS 400/23									
SPAN (m)	INWARDS			Ws kN/m	OUTWARDS			Ws kN/m	
	$\phi_b w_u$ kN/m				$\phi_b w_u$ kN/m				
	1B	2B	3B		1B	2B	3B		
3.0									
3.5									
4.0									
4.5									
5.0									
5.5									
6.0	14.9	14.9	14.9		14.9	14.9	14.9		
6.5	13.4	13.4	13.4		13.4	13.4	13.4		
7.0	12.1	12.1	12.1		12.1	12.1	12.1		
7.5	11.0	11.0	11.0		11.0	11.0	11.0		
8.0	10.1	10.1	10.1		10.1	10.1	10.1		
8.5	9.26	9.26	9.26		9.26	9.26	9.26		
9.0	8.52	8.52	8.52		8.52	8.52	8.52		
9.5	7.89	7.88	7.88		7.88	7.87	7.87		
10.0	7.30	7.30	7.29		7.30	7.30	7.29		
10.5	6.79	6.79	6.79		6.79	6.79	6.79		
11.0	6.33	6.33	6.33		6.33	6.33	6.33		
11.5	5.95	5.98	5.98		5.98	5.98	5.98		
12.0	5.41	5.49	5.49		5.50	5.49	5.49		
12.5	4.92	5.06	5.06		5.13	5.06	5.06		
13.0	4.50	4.68	4.68		4.67	4.68	4.68		
13.5	4.12	4.34	4.34		4.27	4.34	4.34		
14.0	3.79	4.03	4.03		3.90	4.03	4.03		
14.5	3.49	3.76	3.76		3.57	3.76	3.76		
15.0	3.22	3.52	3.52		3.33	3.52	3.52		
15.5	2.98	3.29	3.29		3.10	3.29	3.29		
16.0	2.77	3.09	3.09		2.89	3.09	3.09		
16.5	2.57	2.90	2.90		2.70	2.90	2.90		
17.0	2.40	2.74	2.74		2.49	2.69	2.74		
17.5	2.23	2.58	2.58		2.30	2.50	2.58		
18.0	2.09	2.44	2.44		2.12	2.33	2.44		

Generally not limiting design - verify by calculation

Generally not limiting design - verify by calculation

MSS 400/24									
SPAN (m)	INWARDS			Ws kN/m	OUTWARDS			Ws kN/m	
	$\phi_b w_u$ kN/m				$\phi_b w_u$ kN/m				
	1B	2B	3B		1B	2B	3B		
3.0									
3.5									
4.0									
4.5									
5.0									
5.5									
6.0	17.3	17.3	17.3		17.3	17.3	17.3		
6.5	15.5	15.5	15.5		15.5	15.5	15.5		
7.0	14.0	14.0	14.0		14.0	14.0	14.0		
7.5	12.7	12.7	12.7		12.7	12.7	12.7		
8.0	11.6	11.6	11.6		11.6	11.6	11.6		
8.5	10.6	10.6	10.6		10.6	10.6	10.6		
9.0	9.80	9.80	9.80		9.80	9.80	9.80		
9.5	9.05	9.04	9.04		9.05	9.04	9.04		
10.0	8.49	8.48	8.48		8.49	8.48	8.48		
10.5	7.84	7.84	7.84		7.84	7.84	7.84		
11.0	7.14	7.14	7.14		7.14	7.14	7.14		
11.5	6.56	6.53	6.53		6.53	6.53	6.53		
12.0	5.95	6.00	6.00		6.00	6.00	6.00		
12.5	5.41	5.53	5.53		5.57	5.53	5.53		
13.0	4.95	5.11	5.11		5.18	5.11	5.11		
13.5	4.53	4.74	4.74		4.73	4.74	4.74		
14.0	4.16	4.41	4.41		4.33	4.41	4.41		
14.5	3.83	4.11	4.11		4.02	4.11	4.11		
15.0	3.54	3.84	3.84		3.74	3.84	3.84		
15.5	3.28	3.59	3.59		3.47	3.60	3.59		
16.0	3.04	3.38	3.38		3.23	3.38	3.38		
16.5	2.82	3.17	3.17		2.98	3.17	3.17		
17.0	2.63	2.99	2.99		2.74	2.98	2.99		
17.5	2.45	2.82	2.82		2.52	2.77	2.82		
18.0	2.29	2.67	2.67		2.33	2.58	2.67		

Generally not limiting design - verify by calculation

Generally not limiting design - verify by calculation

- 1B = One mid span brace
- 2B = Two equally spaced braces within the span
- 3B = Three equally spaced braces within the span
- w_s = Uniformly distributed serviceability load (kN/m) for deflection limit of Span/150
- $\phi_b w_u$ = Strength load resistance applied at the centroid (kN/m)

- 2-M12 Grade 4.6 bolts per connection
- 2-M12 Grade 8.8 bolts per connection
- 2-M16 Grade 4.6 bolts per connection
- 2-M16 Grade 8.8 bolts per connection

IMPORTANT

The adequacy of multispan system is very sensitive to actual applied loads. The stated loads in this table are assumed uniform over the full purlin system. Variations in actual project design loadings over the length of the purlin system must be checked specifically by the designer to verify system adequacy.

LAPPED MULTISPAN (INTERNAL SPANS)

LOAD TABLE – Uniformly Distributed Load

MSS 400/30									
SPAN (m)	INWARDS				Ws kN/m	OUTWARDS			
	$\phi_b w_u$ kN/m			Ws kN/m		$\phi_b w_u$ kN/m			Ws kN/m
	1B	2B	3B			1B	2B	3B	
3.0				Generally not limiting design - verify by calculation				Generally not limiting design - verify by calculation	
3.5									
4.0									
4.5									
5.0									
5.5									
6.0	19.4	19.4	19.4			19.4	19.4		19.4
6.5	17.9	17.9	17.9			17.9	17.9		17.9
7.0	16.6	16.6	16.6			16.6	16.6		16.6
7.5	15.5	15.5	15.5			15.5	15.5		15.5
8.0	14.6	14.6	14.6			14.6	14.6		14.6
8.5	14.2	14.2	14.2			14.2	14.2		14.2
9.0	13.3	13.3	13.3			13.3	13.3		13.3
9.5	12.5	12.5	12.5			12.5	12.5		12.5
10.0	11.4	11.4	11.4			11.4	11.4		11.4
10.5	10.4	10.4	10.4			10.4	10.4		10.4
11.0	9.46	9.46	9.46			9.46	9.46		9.46
11.5	8.68	8.65	8.65			8.66	8.65		8.65
12.0	7.88	7.95	7.95		7.94	7.95	7.95		
12.5	7.11	7.32	7.32		7.33	7.32	7.32		
13.0	6.44	6.77	6.77		6.84	6.77	6.77		
13.5	5.85	6.28	6.28		6.47	6.28	6.28		
14.0	5.33	5.84	5.84		5.91	5.84	5.84		
14.5	4.87	5.44	5.44		5.44	5.44	5.44		
15.0	4.46	5.08	5.08		5.01	5.08	5.08		
15.5	4.09	4.76	4.76		4.63	4.76	4.76		
16.0	3.76	4.47	4.47		4.30	4.47	4.47		
16.5	3.46	4.21	4.21		3.93	4.20	4.21		
17.0	3.20	3.96	3.96		3.59	3.96	3.96		
17.5	2.95	3.74	3.74		3.29	3.70	3.74		
18.0	2.73	3.53	3.53		3.01	3.32	3.53		

- 1B = One mid span brace
- 2B = Two equally spaced braces within the span
- 3B = Three equally spaced braces within the span
- w_s = Uniformly distributed serviceability load (kN/m) for deflection limit of Span/150
- $\phi_b w_u$ = Strength load resistance applied at the centroid (kN/m)

- 2-M12 Grade 4.6 bolts per connection
- 2-M12 Grade 8.8 bolts per connection
- 2-M16 Grade 4.6 bolts per connection
- 2-M16 Grade 8.8 bolts per connection

IMPORTANT

The adequacy of multispan system is very sensitive to actual applied loads. The stated loads in this table are assumed uniform over the full purlin system. Variations in actual project design loadings over the length of the purlin system must be checked specifically by the designer to verify system adequacy.

SINGLE SPAN AXIAL LOAD TABLE

	MSS 200/12					MSS 200/15					MSS 200/18					MSS 200/23					
Span (m)	$\phi_c N_{uc}$ kN				N_e kN	$\phi_c N_{uc}$ kN				N_e kN	$\phi_c N_{uc}$ kN				N_e kN	$\phi_c N_{uc}$ kN				N_e kN	Span (m)
	0	1B	2B	3B		0	1B	2B	3B		0	1B	2B	3B		0	1B	2B	3B		
3.0	63.8	81.5	81.5	81.5	646	73.5	116	116	116	808	91.9	147	147	147	966	121	208	213	213	1225	3.0
3.5	48.0	81.5	81.5	81.5	475	59.6	116	116	116	593	71.0	146	147	147	710	89.2	196	213	213	900	3.5
4.0	36.8	81.5	81.5	81.5	363	45.7	112	116	116	454	54.4	136	147	147	544	68.3	182	213	213	689	4.0
4.5	29.0	81.5	81.5	81.5	287	36.1	102	116	116	359	43.0	125	147	147	429	53.9	167	208	213	544	4.5
5.0	23.5	80.4	81.5	81.5	233	29.2	92.6	116	116	291	34.8	114	147	147	348	43.7	152	199	213	441	5.0
5.5	19.4	71.8	81.5	81.5	192	24.2	82.7	116	116	240	28.8	103	142	147	288	36.1	137	190	213	364	5.5
6.0	16.3	63.8	81.5	81.5	161	20.3	73.5	111	116	202	24.2	91.9	135	147	242	30.3	121	181	207	306	6.0
6.5	13.9	55.7	81.5	81.5	138	17.3	66.0	105	116	172	20.6	82.3	128	147	206	25.9	103	171	201	261	6.5
7.0	12.0	48.0	81.5	81.5	119	14.9	59.6	98.5	116	148	17.8	71.0	121	145	177	22.3	89.2	161	194	225	7.0
7.5	10.5	41.8	79.8	81.5	103	13.0	52.0	91.9	116	129	15.5	61.9	113	140	155	19.4	77.7	151	187	196	7.5
8.0	9.2	36.8	74.1	81.5	90.8	11.4	45.7	85.3	111	114	13.6	54.4	106	135	136	17.1	68.3	141	180	172	8.0
8.5	8.1	32.6	68.3	81.5	80.5	10.1	40.5	78.7	106	101	12.0	48.2	98.5	129	120	15.1	60.5	131	173	153	8.5
9.0	7.3	29.0	63.2	81.5	71.8	9.0	36.1	72.9	101	89.7	10.7	43.0	91.1	124	107	13.5	53.9	120	165	136	9.0
9.5	6.5	26.1	57.9	81.5	64.4	8.1	32.4	67.7	96.2	80.5	9.6	38.6	84.5	118	96	12.1	48.4	108	158	122	9.5
10.0	5.9	23.5	52.2	79.2	58.1	7.3	29.2	63.1	91.2	72.7	8.7	34.8	77.2	113	87	10.9	43.7	97.0	150	110	10.0
10.5	5.3	21.3	47.4	74.9	52.7	6.6	26.5	58.9	86.3	65.9	7.9	31.6	70.1	107	79	9.9	39.6	88.0	142	100	10.5
11.0	4.9	19.4	43.2	70.5	48.0	6.0	24.2	53.6	81.2	60.1	7.2	28.8	63.8	101	72	9.0	36.1	80.2	135	91.1	11.0
11.5	4.4	17.8	39.5	66.4	44.0	5.5	22.1	49.1	76.5	55.0	6.6	26.3	58.4	95.6	66	8.3	33.0	73.3	127	83.3	11.5
12.0	4.1	16.3	36.3	62.6	40.4	5.1	20.3	45.1	72.2	50.5	6.0	24.2	53.6	90.2	60	7.6	30.3	67.4	118	76.5	12.0
12.5						4.7	18.7	41.5	68.3	46.5	5.6	22.3	49.4	85.3	56	7.0	28.0	62.1	109	70.5	12.5
13.0						4.3	17.3	38.4	64.7	43.0	5.1	20.6	45.7	80.1	51	6.5	25.9	57.4	101	65.2	13.0
13.5											4.8	19.1	42.4	74.3	48	6.0	24.0	53.2	93.3	60.5	13.5
14.0											4.4	17.8	39.4	69.1	44	5.6	22.3	49.5	86.8	56.2	14.0
14.5																					14.5
15.0																					15.0
15.5																					15.5
16.0																					16.0
16.5																					16.5
17.0																					17.0
17.5																					17.5
18.0																					18.0

NOTE

Bolts required to transfer purlin axial load to be determined by design engineer.

- 0B = No braces
- 1B = One mid span brace
- 2B = Two equally spaced braces within the span
- 3B = Three equally spaced braces within the span
- N_e = Euler buckling load about X-X axis (kN)
- ϕ_c = 0.90
- N_{uc} = Strength resistance applied axial compression load (kN)

SINGLE SPAN AXIAL LOAD TABLE

	MSS 250/13					MSS 250/15					MSS 250/18					MSS 250/23					
Span (m)	$\phi_c N_{uc}$ kN				N_e kN	$\phi_c N_{uc}$ kN				N_e kN	$\phi_c N_{uc}$ kN				N_e kN	$\phi_c N_{uc}$ kN				N_e kN	Span (m)
	0	1B	2B	3B		0	1B	2B	3B		0	1B	2B	3B		0	1B	2B	3B		
3.0	82.9	98.2	98.2	98.2	1300	71	123	123	123	1501	85.1	156	156	156	1798	107	231	231	231	2285	3.0
3.5	67.8	98.2	98.2	98.2	955	56	123	123	123	1102	67.2	156	156	156	1321	84.7	231	231	231	1679	3.5
4.0	56.6	98.2	98.2	98.2	731	46	123	123	123	844	54.5	156	156	156	1012	68.6	215	231	231	1286	4.0
4.5	48.2	98.2	98.2	98.2	578	38	115	123	123	667	45.0	149	156	156	799	56.7	199	231	231	1016	4.5
5.0	39.6	98.2	98.2	98.2	468	32	105	123	123	540	37.8	136	156	156	647	47.7	182	231	231	823	5.0
5.5	32.8	91.0	98.2	98.2	387	27	94.2	123	123	446	32.2	124	156	156	535	40.6	162	231	231	680	5.5
6.0	27.5	82.9	98.2	98.2	325	23	85.2	123	123	375	27.8	111	156	156	450	35.0	140	225	231	571	6.0
6.5	23.5	74.8	98.2	98.2	277	20	77.6	123	123	320	24.2	96.8	156	156	383	30.5	122	214	231	487	6.5
7.0	20.2	67.8	98.2	98.2	239	18	71.0	118	123	276	21.3	85.1	152	156	330	26.8	107	203	231	420	7.0
7.5	17.6	61.8	98.2	98.2	208	16	63.2	111	123	240	18.8	75.4	144	156	288	23.8	95.0	192	231	366	7.5
8.0	15.5	56.6	93.1	98.2	183	14	56.3	104	123	211	16.8	67.2	135	156	253	21.2	84.7	180	230	321	8.0
8.5	13.7	52.1	87.7	98.2	162	13	50.6	96.6	123	187	15.1	60.3	127	156	224	19.0	76.0	169	221	285	8.5
9.0	12.2	48.2	82.2	98.2	144	11	45.6	90.2	123	167	13.6	54.5	118	156	200	17.2	68.6	152	213	254	9.0
9.5	11.0	43.9	76.7	98.2	130	10	41.4	84.4	119	150	12.4	49.4	110	153	179	15.6	62.3	138	205	228	9.5
10.0	9.91	39.6	71.7	97.9	117	9.4	37.7	79.2	113	135	11.3	45.0	100	147	162	14.2	56.7	126	196	206	10.0
10.5	8.99	36.0	67.1	93.9	106	8.6	34.5	74.6	108	122	10.3	41.2	91.4	140	147	13.0	51.9	115	187	187	10.5
11.0	8.19	32.8	63.1	89.8	96.7	7.9	31.7	70.3	103	112	9.5	37.8	83.9	134	134	11.9	47.7	106	179	170	11.0
11.5	7.49	30.0	59.4	85.7	88.5	7.3	29.2	64.8	97.5	102	8.7	34.8	77.4	128	122	11.0	43.9	97.5	170	156	11.5
12.0	6.88	27.5	56.1	81.6	81.2	6.8	27.0	59.9	92.5	93.8	8.1	32.2	71.5	121	112	10.2	40.6	90.2	158	143	12.0
12.5	6.34	25.4	53.1	77.4	74.9	6.3	25.0	55.6	87.9	86.4	7.5	29.9	66.3	115	104	9.4	37.7	83.6	147	132	12.5
13.0	5.86	23.5	50.3	73.4	69.2	5.8	23.3	51.7	83.6	79.9	6.9	27.8	61.7	108	96	8.8	35.0	77.7	136	122	13.0
13.5	5.44	21.7	47.7	69.8	64.2	5.4	21.7	48.2	79.7	74.1	6.5	25.9	57.5	101	89	8.2	32.6	72.5	127	113	13.5
14.0	5.06	20.2	44.9	66.5	59.7	5.1	20.3	45.0	76.1	68.9	6.0	24.2	53.7	94.2	83	7.6	30.5	67.7	119	105	14.0
14.5	4.71	18.9	41.8	63.5	55.6	4.7	19.0	42.2	72.8	64.2	5.7	22.7	50.3	88.2	77	7.1	28.6	63.4	111	98	14.5
15.0	4.40	17.6	39.1	60.6	52.0	4.5	17.8	39.6	69.4	60.0	5.3	21.3	47.2	82.8	72	6.7	26.8	59.5	104	91	15.0
15.5											5.0	20.0	44.4	77.8	67	6.3	25.2	56.0	98.1	86	15.5
16.0											4.7	18.8	41.8	73.3	63	5.9	23.8	52.7	92.4	80	16.0
16.5																					16.5
17.0																					17.0
17.5																					17.5
18.0																					18.0

NOTE

Bolts required to transfer purlin axial load to be determined by design engineer.

- 0B = No braces
- 1B = One mid span brace
- 2B = Two equally spaced braces within the span
- 3B = Three equally spaced braces within the span
- N_e = Euler buckling load about X-X axis (kN)
- ϕ_c = 0.90
- Nuc = Strength resistance applied axial compression load (kN)

SINGLE SPAN AXIAL LOAD TABLE

Span (m)	MSS 275/15					MSS 275/18					MSS 300/15					MSS 300/18					Span (m)			
	$\phi_c N_{uc}$ kN				Ne kN	$\phi_c N_{uc}$ kN				Ne kN	$\phi_c N_{uc}$ kN				Ne kN	$\phi_c N_{uc}$ kN				Ne kN				
	0	1B	2B	3B		0	1B	2B	3B		0	1B	2B	3B		0	1B	2B	3B			0	1B	2B
3.0																							3.0	
3.5																								3.5
4.0	71.1	122	122	122	1092	95	155	155	155	1309													4.0	
4.5	60.7	122	122	122	863	79	155	155	155	1034														4.5
5.0	52.5	121	122	122	699	64	155	155	155	838	62	128	128	128	919	83	163.1	163.1	163.1	1102				5.0
5.5	44.1	112	122	122	577	53	147	155	155	692	55	124	128	128	760	72	162.6	163.1	163.1	911				5.5
6.0	37.0	103	122	122	485	44	136	155	155	582	49	116	128	128	638	60	152.8	163.1	163.1	765				6.0
6.5	31.6	93.8	122	122	413	38	125	155	155	496	43	108	128	128	544	52	142.8	163.1	163.1	652				6.5
7.0	27.2	85.0	122	122	356	32	114	155	155	427	37	99.6	128	128	469	44	132.7	163.1	163.1	562				7.0
7.5	23.7	77.6	121	122	311	28	104	155	155	372	32	91.3	128	128	408	39	122.6	163.1	163.1	490				7.5
8.0	20.8	71.1	115	122	273	25	94.8	150	155	327	28	83.9	126	128	359	34	112.6	163.1	163.1	431				8.0
8.5	18.5	65.6	108	122	242	22	87.2	143	155	290	25	77.4	121	128	318	30	103.8	158.7	163.1	381				8.5
9.0	16.5	60.7	102	122	216	20	78.6	135	155	259	22	71.8	116	128	284	27	96.1	152	163.1	340				9.0
9.5	14.8	56.4	96.1	122	194	18	70.6	128	155	232	20	66.8	110	128	255	24	89.3	145.3	163.1	305				9.5
10.0	13.3	52.5	89.9	120	175	16	63.7	120	155	209	18	62.3	104	128	230	22	83.3	138.6	163.1	276				10.0
10.5	12.1	48.4	84.3	115	158	14	57.8	113	151	190	17	58.4	98.9	127	208	20	77.9	131.8	163.1	250				10.5
11.0	11.0	44.1	79.2	111	144	13	52.6	106	145	173	15	54.8	93.2	123	190	18	72.0	125	161.2	228				11.0
11.5	10.1	40.3	74.6	106	132	12	48.2	99.5	140	158	14	51.6	87.9	119	174	16	65.9	118.1	156.2	208				11.5
12.0	9.3	37.0	70.5	102	121	11	44.2	93.9	134	145	13	48.7	83.1	115	160	15	60.4	111.5	151.2	191				12.0
12.5	8.5	34.1	66.7	96.8	112	10	40.8	88.8	129	134	12	46.0	78.8	111	147	14	55.8	105.6	146.1	176				12.5
13.0	7.9	31.6	63.3	92.1	103	9.4	37.7	83.7	123	124	11	43.1	74.8	107	136	13	51.6	100.2	141	163				13.0
13.5	7.3	29.3	60.1	87.6	96	8.7	34.9	77.6	117	115	10	40.0	71.1	102	126	12	47.8	95.2	135.9	151				13.5
14.0	6.8	27.2	57.2	83.5	89	8.1	32.5	72.1	112	107	9.3	37.2	67.8	98.0	117	11	44.4	90.6	130.8	141				14.0
14.5	6.3	25.4	54.5	79.7	83	7.6	30.3	67.2	106	100	8.7	34.6	64.7	93.7	109	10	41.4	86.4	125.6	131				14.5
15.0	5.9	23.7	52.1	76.2	78	7.1	28.3	62.8	102	93	8.1	32.4	61.8	89.7	102	9.7	38.7	82.5	120.4	122				15.0
15.5	5.5	22.2	49.3	72.9	73	6.6	26.5	58.8	97.1	87	7.6	30.3	59.1	85.9	96	9.1	36.3	78.9	115.3	115				15.5
16.0	5.2	20.8	46.2	69.9	68	6.2	24.9	55.2	93.0	82	7.1	28.4	56.6	82.4	90	8.5	34.0	75.5	110.5	108				16.0
16.5	4.9	19.6	43.5	67.0	64	5.8	23.4	51.9	89.2	77	6.7	26.7	54.3	79.1	84	8.0	32.0	71.0	106.1	101				16.5
17.0	4.6	18.5	41.0	64.4	60	5.5	22.0	48.9	85.6	72	6.3	25.2	52.2	76.0	80	7.5	30.1	66.9	101.9	95				17.0
17.5	4.4	17.4	38.7	61.9	57	5.2	20.8	46.2	80.9	68	5.9	23.8	50.1	73.2	75	7.1	28.4	63.1	98.0	90				17.5
18.0	4.1	16.5	36.5	59.6	54	4.9	19.7	43.6	76.5	65	5.6	22.5	48.2	70.5	71	6.7	26.9	59.7	94.3	85				18.0

NOTE

Bolts required to transfer purlin axial load to be determined by design engineer.

- 0B = No braces
- 1B = One mid span brace
- 2B = Two equally spaced braces within the span
- 3B = Three equally spaced braces within the span
- Ne = Euler buckling load about X-X axis (kN)
- ϕ_c = 0.90
- N_{uc} = Strength resistance applied axial compression load (kN)

SINGLE SPAN AXIAL LOAD TABLE

Span (m)	MSS 300/23					MSS 300/30					MSS 325/15					MSS 325/18					Span (m)		
	$\phi_c N_{uc}$ kN				N_e kN	$\phi_c N_{uc}$ kN				N_e kN	$\phi_c N_{uc}$ kN				N_e kN	$\phi_c N_{uc}$ kN				N_e kN			
	0	1B	2B	3B		0	1B	2B	3B		0	1B	2B	3B		0	1B	2B	3B				
3.0																						3.0	
3.5																							3.5
4.0																							4.0
4.5																							4.5
5.0	110	240	240	240	1402	144	341	377	377	1841	63	124	124	124	1109	84	158	158	158	1331		5.0	
5.5	91.1	237	240	240	1159	119	322	377	377	1522	55	124	124	124	917	74	158	158	158	1100		5.5	
6.0	76.6	222	240	240	974	99.7	302	377	377	1279	49	118	124	124	770	62	155	158	158	924		6.0	
6.5	65.2	207	240	240	830	84.9	281	365	377	1090	44	109	124	124	656	53	145	158	158	788		6.5	
7.0	56.2	192	240	240	715	73.2	260	353	377	939	38	101	124	124	566	46	134	158	158	679		7.0	
7.5	49.0	177	240	240	623	63.8	239	340	377	818	33	92.3	124	124	493	40	124	158	158	592		7.5	
8.0	43.1	162	240	240	548	56.1	219	327	376	719	29	84.8	124	124	433	35	114	158	158	520		8.0	
8.5	38.2	149	231	240	485	49.7	199	314	367	637	26	78.3	123	124	384	31	105	158	158	461		8.5	
9.0	34.0	136	221	240	433	44.3	177	300	358	568	23	72.6	117	124	342	28	97.2	154	158	411		9.0	
9.5	30.5	122	211	240	388	39.8	159	286	348	510	21	67.5	111	124	307	25	90.4	147	158	369		9.5	
10.0	27.6	110	201	240	351	35.9	144	272	339	460	19	63.1	106	124	277	22	84.3	140	158	333		10.0	
10.5	25.0	100	191	240	318	32.6	130	258	329	418	17	59.1	100	124	252	20	78.8	133	158	302		10.5	
11.0	22.8	91.1	181	235	290	29.7	119	244	319	380	15	55.5	94.2	124	229	19	74.0	127	158	275		11.0	
11.5	20.8	83.4	170	227	265	27.1	109	230	309	348	14	52.2	88.9	121	210	17	67.8	119	158	252		11.5	
12.0	19.1	76.6	161	220	243	24.9	99.7	217	298	320	13	49.3	84.0	116	193	16	62.3	113	153	231		12.0	
12.5	17.6	70.6	152	212	224	23.0	91.9	204	288	295	12	46.6	79.6	112	177	14	57.4	107	148	213		12.5	
13.0	16.3	65.2	144	205	207	21.2	84.9	189	277	272	11	44.2	75.6	108	164	13	53.0	101	143	197		13.0	
13.5	15.1	60.5	134	197	192	19.7	78.8	175	267	253	10	41.2	71.9	103	152	12	49.2	96.3	138	183		13.5	
14.0	14.1	56.2	125	189	179	18.3	73.2	163	256	235	9.6	38.3	68.5	99.1	141	11	45.7	91.7	132	170		14.0	
14.5	13.1	52.4	116	182	167	17.1	68.3	152	246	219	8.9	35.7	65.4	94.7	132	11	42.6	87.5	127	158		14.5	
15.0	12.3	49.0	109	174	156	16.0	63.8	142	235	205	8.3	33.3	62.5	90.6	123	10	39.8	83.5	122	148		15.0	
15.5	11.5	45.9	102	166	146	14.9	59.8	133	225	192	7.8	31.2	59.8	86.8	115	9.3	37.3	79.8	117	139		15.5	
16.0	10.8	43.1	95.6	159	137	14.0	56.1	125	215	180	7.3	29.3	57.3	83.3	108	8.8	35.0	76.4	112	130		16.0	
16.5	10.1	40.5	89.9	153	129	13.2	52.7	117	205	169	6.9	27.5	55.0	80.0	102	8.2	32.9	73.1	107	122		16.5	
17.0	9.5	38.2	84.7	147	121	12.4	49.7	110	193	159	6.5	26.0	52.8	76.9	96	7.8	31.0	68.9	103	115		17.0	
17.5	9.0	36.0	79.9	140	114	11.7	46.9	104	182	150	6.1	24.5	50.8	74.0	91	7.3	29.3	65.0	99.1	109		17.5	
18.0	8.5	34.0	75.5	132	108	11.1	44.3	98.4	173	142	5.8	23.1	48.8	71.3	86	6.9	27.7	61.4	95.4	103		18.0	

NOTE

Bolts required to transfer purlin axial load to be determined by design engineer.

- 0B = No braces
- 1B = One mid span brace
- 2B = Two equally spaced braces within the span
- 3B = Three equally spaced braces within the span
- N_e = Euler buckling load about X-X axis (kN)
- ϕ_c = 0.90
- Nuc = Strength resistance applied axial compression load (kN)

SINGLE SPAN AXIAL LOAD TABLE

Span (m)	MSS 350/18					MS 350/23					MSS 350/24					MSS 350/30					Span (m)			
	$\phi_c N_{uc}$ kN				N_e kN	$\phi_c N_{uc}$ kN				N_e kN	$\phi_c N_{uc}$ kN				N_e kN	$\phi_c N_{uc}$ kN				N_e kN				
	0	1B	2B	3B		0	1B	2B	3B		0	1B	2B	3B		0	1B	2B	3B			0	1B	2B
3.0																							3.0	
3.5																								3.5
4.0																								4.0
4.5																								4.5
5.0	82	159	159	159	1612	117	230	230	230	2053	129	259	259	259	2183	186	353	365	365	2698			5.0	
5.5	72	158	159	159	1332	101	228	230	230	1697	108	253	259	259	1804	162	336	365	365	2230			5.5	
6.0	64	148	159	159	1119	85.1	214	230	230	1426	90.5	237	259	259	1516	137	319	365	365	1874			6.0	
6.5	57	139	159	159	954	72.6	200	230	230	1215	77.1	222	259	259	1292	118	301	365	365	1596			6.5	
7.0	49	129	159	159	822	62.6	186	230	230	1047	66.5	206	259	259	1114	103	284	363	365	1377			7.0	
7.5	43	119	159	159	716	54.5	172	230	230	912	57.9	190	259	259	970	90.6	266	352	365	1199			7.5	
8.0	38	110	159	159	629	47.9	158	230	230	802	50.9	174	257	259	853	80.5	248	341	365	1054			8.0	
8.5	33	101	154	159	558	42.4	146	222	230	710	45.1	160	246	259	755	72.2	229	329	365	934			8.5	
9.0	30	93.9	147	159	497	37.8	135	213	230	634	40.2	149	236	259	674	65.1	213	318	365	833			9.0	
9.5	27	87.4	141	159	446	34.0	126	204	230	569	36.1	138	225	259	605	59.2	199	306	359	747			9.5	
10.0	24	81.6	135	159	403	30.7	117	195	230	513	32.6	129	215	259	546	54.1	186	294	351	674			10.0	
10.5	22	76.5	128	159	365	27.8	110	185	230	466	29.5	118	204	258	495	49.7	175	282	342	612			10.5	
11.0	20	71.8	122	156	333	25.3	101	176	226	424	26.9	108	194	250	451	45.9	162	270	334	557			11.0	
11.5	18	67.6	115	151	305	23.2	92.7	166	219	388	24.6	98.5	183	243	413	42.6	149	258	325	510			11.5	
12.0	17	63.8	109	147	280	21.3	85.1	157	212	356	22.6	90.5	173	235	379	39.6	137	246	316	468			12.0	
12.5	15	60.3	103	142	258	19.6	78.5	149	205	328	20.8	83.4	163	227	349	37.1	127	233	307	432			12.5	
13.0	14	57.2	97.9	137	238	18.1	72.6	141	198	304	19.3	77.1	155	219	323	34.8	118	222	298	399			13.0	
13.5	13	53.1	93.1	132	221	16.8	67.3	134	191	282	17.9	71.5	147	211	299	32.7	110	211	289	370			13.5	
14.0	12	49.4	88.7	127	206	15.6	62.6	128	184	262	16.6	66.5	140	203	278	30.9	103	202	280	344			14.0	
14.5	12	46.0	84.7	122	192	14.6	58.3	122	177	244	15.5	62.0	134	195	260	29.3	96.4	193	271	321			14.5	
15.0	11	43.0	80.9	117	179	13.6	54.5	116	170	228	14.5	57.9	127	186	243	27.8	90.6	185	262	300			15.0	
15.5	10	40.3	77.4	112	168	12.8	51.0	111	162	214	13.6	54.2	120	178	227	26.5	85.3	177	253	281			15.5	
16.0	9.5	37.8	74.2	108	157	12.0	47.9	106	156	200	12.7	50.9	113	171	213	25.3	80.5	169	244	263			16.0	
16.5	8.9	35.5	71.2	104	148	11.3	45.0	100	149	189	12.0	47.8	106	164	200	24.1	76.2	160	234	248			16.5	
17.0	8.4	33.5	68.3	100	139	10.6	42.4	94.2	143	178	11.3	45.1	100	158	189	23.1	72.2	151	225	233			17.0	
17.5	7.9	31.6	65.7	95.8	132	10.0	40.0	88.9	138	168	10.6	42.5	94.4	151	178	22.2	68.5	143	217	220			17.5	
18.0	7.5	29.9	63.2	92.3	124	9.5	37.8	84.0	133	158	10.1	40.2	89.3	146	168	21.4	65.1	135	210	208			18.0	

NOTE

Bolts required to transfer purlin axial load to be determined by design engineer.

- 0B = No braces
- 1B = One mid span brace
- 2B = Two equally spaced braces within the span
- 3B = Three equally spaced braces within the span
- N_e = Euler buckling load about X-X axis (kN)
- ϕ_c = 0.90
- N_{uc} = Strength resistance applied axial compression load (kN)

SINGLE SPAN AXIAL LOAD TABLE

	MSS 400/20					MSS 400/23					MSS 400/24					MSS 400/30							
Span (m)	$\phi_c N_{uc}$ kN				N_e kN	$\phi_c N_{uc}$ kN				N_e kN	$\phi_c N_{uc}$ kN				N_e kN	$\phi_c N_{uc}$ kN				N_e kN	Span (m)		
	0	1B	2B	3B		0	1B	2B	3B		0	1B	2B	3B		0	1B	2B	3B				
2.0																						2.0	
2.5																							2.5
3.0																							3.0
3.5																							3.5
4.0																							4.0
4.5																							4.5
5.0	90.0	180	180	180	2493	111	225	225	225	2862	122	240	240	240	3045	160	332	352	352	3765		5.0	
5.5	79.3	173	180	180	2061	97.9	216	225	225	2365	107	237	240	240	2516	140	313	352	352	3112		5.5	
6.0	70.5	163	180	180	1732	87.0	203	225	225	1988	95.0	222	240	240	2114	121	294	352	352	2615		6.0	
6.5	63.3	152	180	180	1475	78.0	190	225	225	1694	83.6	208	240	240	1802	103	274	352	352	2228		6.5	
7.0	57.2	142	180	180	1272	67.8	176	225	225	1460	72.1	193	240	240	1553	88.7	255	343	352	1921		7.0	
7.5	51.6	131	180	180	1108	59.1	163	225	225	1272	62.8	178	240	240	1353	77.3	235	331	352	1674		7.5	
8.0	45.4	121	176	180	974	51.9	150	219	225	1118	55.2	164	240	240	1189	67.9	216	318	352	1471		8.0	
8.5	40.2	111	169	180	863	46.0	138	211	225	990	48.9	151	231	240	1053	60.2	199	305	352	1303		8.5	
9.0	35.8	103	162	180	770	41.0	128	202	225	883	43.6	140	221	240	940	53.7	184	292	347	1162		9.0	
9.5	32.2	96.3	155	180	691	36.8	119	193	225	793	39.2	130	211	240	843	48.2	171	279	338	1043		9.5	
10.0	29.0	90.0	148	180	623	33.2	111	184	225	716	35.3	122	202	240	761	43.5	160	266	329	941		10.0	
10.5	26.3	84.3	141	177	565	30.1	104	175	220	649	32.0	114	192	240	690	39.4	149	253	320	854		10.5	
11.0	24.0	79.3	134	172	515	27.5	97.9	166	214	591	29.2	107	182	235	629	35.9	140	240	310	778		11.0	
11.5	22.0	74.7	126	167	471	25.1	92.2	157	207	541	26.7	101	172	227	576	32.9	132	226	301	712		11.5	
12.0	20.2	70.5	120	161	433	23.1	87.0	148	201	497	24.5	95.0	162	220	529	30.2	121	214	291	654		12.0	
12.5	18.6	66.8	113	156	399	21.3	82.3	141	194	458	22.6	89.8	154	213	487	27.8	111	202	281	602		12.5	
13.0	17.2	63.3	108	151	369	19.7	78.0	134	187	423	20.9	83.6	146	205	450	25.7	103	192	271	557		13.0	
13.5	15.9	60.1	103	145	342	18.2	72.9	127	181	393	19.4	77.5	139	198	418	23.9	95.4	183	261	517		13.5	
14.0	14.8	57.2	97.7	140	318	17.0	67.8	121	174	365	18.0	72.1	132	190	388	22.2	88.7	174	251	480		14.0	
14.5	13.8	54.5	93.3	134	296	15.8	63.2	116	167	340	16.8	67.2	126	183	362	20.7	82.7	166	241	448		14.5	
15.0	12.9	51.6	89.2	129	277	14.8	59.1	110	160	318	15.7	62.8	121	175	338	19.3	77.3	158	231	418		15.0	
15.5	12.1	48.3	85.4	123	259	13.8	55.3	106	153	298	14.7	58.8	115	168	317	18.1	72.4	151	221	392		15.5	
16.0	11.3	45.4	81.8	118	244	13.0	51.9	101	147	280	13.8	55.2	111	161	297	17.0	67.9	145	212	368		16.0	
16.5	10.7	42.7	78.6	114	229	12.2	48.8	97.1	141	263	13.0	51.9	106	154	280	16.0	63.9	139	203	346		16.5	
17.0	10.1	40.2	75.5	109	216	11.5	46.0	93.2	136	248	12.2	48.9	102	148	263	15.0	60.2	133	195	326		17.0	
17.5	9.5	37.9	72.6	105	204	10.9	43.4	89.6	131	234	11.5	46.1	97.9	143	249	14.2	56.8	126	188	307		17.5	
18.0	9.0	35.8	69.9	102	192	10.3	41.0	86.2	126	221	10.9	43.6	94.2	138	235	13.4	53.7	119	181	291		18.0	

NOTE

Bolts required to transfer purlin axial load to be determined by design engineer.

- 0B = No braces
- 1B = One mid span brace
- 2B = Two equally spaced braces within the span
- 3B = Three equally spaced braces within the span
- N_e = Euler buckling load about X-X axis (kN)
- ϕ_c = 0.90
- Nuc = Strength resistance applied axial compression load (kN)



MSS PURLINS CONTINUOUS

CONTENTS

Two Span Continuous	102
Three Span Continuous	117
Multispan Continuous (End Span)	132
Multispan Continuous (Internal Spans)	147

TWO SPAN CONTINUOUS

LOAD TABLE – Uniformly Distributed Load

MSS 150/12								
SPAN (m)	INWARDS				OUTWARDS			
	$\phi_b w_u$ kN/m			W_s kN/m	$\phi_b w_u$ kN/m			W_s kN/m
	1B	2B	3B		1B	2B	3B	
3.0	5.48	5.48	5.48	12.51	5.48	5.48	5.48	12.51
3.5	4.03	4.03	4.03	7.88	4.03	4.03	4.03	7.88
4.0	3.08	3.08	3.08	5.28	3.08	3.08	3.08	5.28
4.5	2.44	2.44	2.44	3.71	2.44	2.44	2.44	3.71
5.0	1.97	1.97	1.97	2.70	1.97	1.97	1.97	2.70
5.5	1.63	1.63	1.63	2.03	1.63	1.63	1.63	2.03
6.0	1.37	1.37	1.37	1.56	1.37	1.37	1.37	1.56
6.5	1.17	1.17	1.17	1.23	1.17	1.17	1.17	1.23
7.0	1.01	1.01	1.01	0.98	1.01	1.01	1.01	0.98
7.5	0.88	0.88	0.88	0.80	0.87	0.88	0.88	0.80
8.0	0.77	0.77	0.77	0.66	0.75	0.77	0.77	0.66
8.5	0.68	0.68	0.68	0.55	0.64	0.68	0.68	0.55
9.0	0.61	0.61	0.61	0.46	0.56	0.61	0.61	0.46
9.5	0.55	0.55	0.55	0.39	0.48	0.55	0.55	0.39
10.0	0.49	0.49	0.49	0.34	0.41	0.49	0.49	0.34
10.5	0.45	0.45	0.45	0.29	0.36	0.44	0.45	0.29
11.0	0.41	0.41	0.41	0.25	0.31	0.40	0.41	0.25
11.5								
12.0								
12.5								
13.0								
13.5								
14.0								
14.5								
15.0								
15.5								
16.0								
16.5								
17.0								
17.5								
18.0								

MSS 150/15								
SPAN (m)	INWARDS				OUTWARDS			
	$\phi_b w_u$ kN/m			W_s kN/m	$\phi_b w_u$ kN/m			W_s kN/m
	1B	2B	3B		1B	2B	3B	
3.0	7.49	7.49	7.49	15.61	7.49	7.49	7.49	15.61
3.5	5.50	5.51	5.51	9.83	5.50	5.51	5.51	9.83
4.0	4.21	4.21	4.21	6.59	4.21	4.21	4.21	6.59
4.5	3.33	3.33	3.33	4.62	3.33	3.33	3.33	4.62
5.0	2.70	2.70	2.70	3.37	2.70	2.70	2.70	3.37
5.5	2.23	2.23	2.23	2.53	2.23	2.23	2.23	2.53
6.0	1.87	1.87	1.87	1.95	1.87	1.87	1.87	1.95
6.5	1.60	1.60	1.60	1.53	1.60	1.60	1.60	1.53
7.0	1.38	1.38	1.38	1.23	1.38	1.38	1.38	1.23
7.5	1.20	1.20	1.20	1.00	1.20	1.20	1.20	1.00
8.0	1.05	1.05	1.05	0.82	1.02	1.05	1.05	0.82
8.5	0.93	0.93	0.93	0.69	0.87	0.93	0.93	0.69
9.0	0.83	0.83	0.83	0.58	0.75	0.83	0.83	0.58
9.5	0.75	0.75	0.75	0.49	0.65	0.75	0.75	0.49
10.0	0.67	0.67	0.67	0.42	0.56	0.67	0.67	0.42
10.5	0.61	0.61	0.61	0.36	0.48	0.61	0.61	0.36
11.0	0.56	0.56	0.56	0.32	0.41	0.54	0.56	0.32
11.5								
12.0								
12.5								
13.0								
13.5								
14.0								
14.5								
15.0								
15.5								
16.0								
16.5								
17.0								
17.5								
18.0								

- 1B = One mid span brace
- 2B = Two equally spaced braces within the span
- 3B = Three equally spaced braces within the span
- w_s = Uniformly distributed serviceability load (kN/m) for deflection limit of Span/150
- $\phi_b w_u$ = Strength load resistance applied at the centroid (kN/m)

- 2-M12 Grade 4.6 bolts per connection
- 2-M12 Grade 8.8 bolts per connection
- 2-M16 Grade 4.6 bolts per connection
- 2-M16 Grade 8.8 bolts per connection

IMPORTANT

The adequacy of multispan system is very sensitive to actual applied loads. The stated loads in this table are assumed uniform over the full purlin system. Variations in actual project design loadings over the length of the purlin system must be checked specifically by the designer to verify system adequacy.

TWO SPAN CONTINUOUS

LOAD TABLE – Uniformly Distributed Load

MSS 150/18								
SPAN (m)	INWARDS				OUTWARDS			
	$\phi_b w_u$ kN/m			w_s kN/m	$\phi_b w_u$ kN/m			w_s kN/m
	1B	2B	3B		1B	2B	3B	
3.0	8.95	8.95	8.95	18.62	8.95	8.95	8.95	18.62
3.5	6.58	6.58	6.58	11.73	6.58	6.58	6.58	11.73
4.0	5.03	5.03	5.03	7.86	5.03	5.03	5.03	7.86
4.5	3.98	3.98	3.98	5.52	3.98	3.98	3.98	5.52
5.0	3.22	3.22	3.22	4.02	3.22	3.22	3.22	4.02
5.5	2.66	2.66	2.66	3.02	2.66	2.66	2.66	3.02
6.0	2.24	2.24	2.24	2.33	2.24	2.24	2.24	2.33
6.5	1.91	1.91	1.91	1.83	1.91	1.91	1.91	1.83
7.0	1.64	1.64	1.64	1.47	1.64	1.64	1.64	1.47
7.5	1.43	1.43	1.43	1.19	1.41	1.43	1.43	1.19
8.0	1.26	1.26	1.26	0.98	1.21	1.26	1.26	0.98
8.5	1.12	1.12	1.12	0.82	1.04	1.12	1.12	0.82
9.0	0.99	0.99	0.99	0.69	0.89	0.99	0.99	0.69
9.5	0.89	0.89	0.89	0.59	0.77	0.89	0.89	0.59
10.0	0.81	0.81	0.81	0.50	0.67	0.81	0.81	0.50
10.5	0.73	0.73	0.73	0.43	0.58	0.72	0.73	0.43
11.0	0.66	0.67	0.67	0.38	0.50	0.64	0.67	0.38
11.5								
12.0								
12.5								
13.0								
13.5								
14.0								
14.5								
15.0								
15.5								
16.0								
16.5								
17.0								
17.5								
18.0								

MSS 150/23								
SPAN (m)	INWARDS				OUTWARDS			
	$\phi_b w_u$ kN/m			w_s kN/m	$\phi_b w_u$ kN/m			w_s kN/m
	1B	2B	3B		1B	2B	3B	
3.0	12.3	12.3	12.3	23.55	12.3	12.3	12.3	23.55
3.5	9.06	9.06	9.06	14.83	9.06	9.06	9.06	14.83
4.0	6.93	6.93	6.93	9.94	6.93	6.93	6.93	9.94
4.5	5.48	5.48	5.48	6.98	5.48	5.48	5.48	6.98
5.0	4.44	4.44	4.44	5.09	4.44	4.44	4.44	5.09
5.5	3.67	3.67	3.67	3.82	3.67	3.67	3.67	3.82
6.0	3.08	3.08	3.08	2.94	3.07	3.08	3.08	2.94
6.5	2.63	2.63	2.63	2.32	2.56	2.63	2.63	2.32
7.0	2.26	2.26	2.26	1.85	2.15	2.26	2.26	1.85
7.5	1.95	1.97	1.97	1.51	1.82	1.97	1.97	1.51
8.0	1.70	1.73	1.73	1.24	1.55	1.73	1.73	1.24
8.5	1.49	1.54	1.54	1.04	1.33	1.52	1.54	1.04
9.0	1.31	1.37	1.37	0.87	1.14	1.34	1.37	0.87
9.5	1.16	1.23	1.23	0.74	0.99	1.18	1.23	0.74
10.0	1.04	1.11	1.11	0.64	0.86	1.04	1.11	0.64
10.5	0.93	1.01	1.01	0.55	0.74	0.92	1.00	0.55
11.0	0.83	0.91	0.92	0.48	0.65	0.82	0.90	0.48
11.5								
12.0								
12.5								
13.0								
13.5								
14.0								
14.5								
15.0								
15.5								
16.0								
16.5								
17.0								
17.5								
18.0								

- 1B = One mid span brace
- 2B = Two equally spaced braces within the span
- 3B = Three equally spaced braces within the span
- w_s = Uniformly distributed serviceability load (kN/m) for deflection limit of Span/150
- $\phi_b w_u$ = Strength load resistance applied at the centroid (kN/m)

- 2-M12 Grade 4.6 bolts per connection
- 2-M12 Grade 8.8 bolts per connection
- 2-M16 Grade 4.6 bolts per connection
- 2-M16 Grade 8.8 bolts per connection

IMPORTANT

The adequacy of multispan system is very sensitive to actual applied loads. The stated loads in this table are assumed uniform over the full purlin system. Variations in actual project design loadings over the length of the purlin system must be checked specifically by the designer to verify system adequacy.

TWO SPAN CONTINUOUS

LOAD TABLE – Uniformly Distributed Load

MSS 200/12								
SPAN (m)	INWARDS				OUTWARDS			
	$\phi_b w_u$ kN/m			W_s kN/m	$\phi_b w_u$ kN/m			W_s kN/m
	1B	2B	3B		1B	2B	3B	
3.0	7.10	7.10	7.10	26.93	7.10	7.10	7.10	26.93
3.5	5.47	5.47	5.47	16.96	5.47	5.47	5.47	16.96
4.0	4.33	4.34	4.33	11.36	4.33	4.34	4.33	11.36
4.5	3.46	3.46	3.46	7.98	3.46	3.46	3.46	7.98
5.0	2.80	2.80	2.80	5.82	2.80	2.80	2.80	5.82
5.5	2.31	2.31	2.31	4.37	2.31	2.31	2.31	4.37
6.0	1.94	1.94	1.94	3.37	1.94	1.94	1.94	3.37
6.5	1.66	1.66	1.66	2.65	1.66	1.66	1.66	2.65
7.0	1.43	1.43	1.43	2.12	1.43	1.43	1.43	2.12
7.5	1.24	1.24	1.24	1.72	1.24	1.24	1.24	1.72
8.0	1.09	1.09	1.09	1.42	1.08	1.09	1.09	1.42
8.5	0.97	0.97	0.97	1.18	0.93	0.97	0.97	1.18
9.0	0.86	0.86	0.86	1.00	0.81	0.86	0.86	1.00
9.5	0.78	0.78	0.78	0.85	0.71	0.78	0.78	0.85
10.0	0.70	0.70	0.70	0.73	0.62	0.70	0.70	0.73
10.5	0.63	0.63	0.63	0.63	0.55	0.63	0.63	0.63
11.0	0.58	0.58	0.58	0.55	0.48	0.57	0.58	0.55
11.5	0.53	0.53	0.53	0.48	0.43	0.51	0.53	0.48
12.0	0.48	0.49	0.49	0.42	0.37	0.46	0.49	0.42
12.5	0.44	0.45	0.45	0.37	0.33	0.42	0.45	0.37
13.0	0.40	0.41	0.41	0.33	0.29	0.38	0.41	0.33
13.5	0.37	0.38	0.38	0.30	0.26	0.35	0.38	0.30
14.0	0.34	0.36	0.36	0.26	0.23	0.31	0.35	0.26
14.5	0.31	0.33	0.33	0.24	0.20	0.29	0.32	0.24
15.0	0.29	0.31	0.31	0.22	0.18	0.26	0.30	0.22
15.5								
16.0								
16.5								
17.0								
17.5								
18.0								

MSS 200/15								
SPAN (m)	INWARDS				OUTWARDS			
	$\phi_b w_u$ kN/m			W_s kN/m	$\phi_b w_u$ kN/m			W_s kN/m
	1B	2B	3B		1B	2B	3B	
3.0	10.7	10.7	10.7	33.59	10.7	10.7	10.7	33.59
3.5	7.88	7.88	7.88	21.15	7.88	7.88	7.88	21.15
4.0	6.03	6.03	6.03	14.17	6.03	6.03	6.03	14.17
4.5	4.77	4.76	4.76	9.95	4.77	4.76	4.76	9.95
5.0	3.86	3.86	3.86	7.26	3.86	3.86	3.86	7.26
5.5	3.19	3.19	3.19	5.45	3.19	3.19	3.19	5.45
6.0	2.68	2.68	2.68	4.20	2.68	2.68	2.68	4.20
6.5	2.28	2.28	2.28	3.30	2.28	2.28	2.28	3.30
7.0	1.97	1.97	1.97	2.64	1.97	1.97	1.97	2.64
7.5	1.72	1.72	1.72	2.15	1.72	1.72	1.72	2.15
8.0	1.51	1.51	1.51	1.77	1.51	1.51	1.51	1.77
8.5	1.34	1.34	1.34	1.48	1.34	1.34	1.34	1.48
9.0	1.19	1.19	1.19	1.24	1.19	1.19	1.19	1.24
9.5	1.07	1.07	1.07	1.06	1.05	1.07	1.07	1.06
10.0	0.96	0.96	0.96	0.91	0.92	0.96	0.96	0.91
10.5	0.88	0.88	0.88	0.78	0.81	0.88	0.88	0.78
11.0	0.80	0.80	0.80	0.68	0.71	0.80	0.80	0.68
11.5	0.73	0.73	0.73	0.60	0.62	0.73	0.73	0.60
12.0	0.67	0.67	0.67	0.52	0.54	0.67	0.67	0.52
12.5	0.62	0.62	0.62	0.46	0.47	0.62	0.62	0.46
13.0	0.57	0.57	0.57	0.41	0.41	0.56	0.57	0.41
13.5	0.53	0.53	0.53	0.37	0.35	0.51	0.53	0.37
14.0	0.49	0.49	0.49	0.33	0.31	0.46	0.49	0.33
14.5	0.45	0.46	0.46	0.30	0.27	0.42	0.46	0.30
15.0	0.42	0.43	0.43	0.27	0.24	0.38	0.43	0.27
15.5								
16.0								
16.5								
17.0								
17.5								
18.0								

- 1B = One mid span brace
- 2B = Two equally spaced braces within the span
- 3B = Three equally spaced braces within the span
- w_s = Uniformly distributed serviceability load (kN/m) for deflection limit of Span/150
- $\phi_b w_u$ = Strength load resistance applied at the centroid (kN/m)

- 2-M12 Grade 4.6 bolts per connection
- 2-M12 Grade 8.8 bolts per connection
- 2-M16 Grade 4.6 bolts per connection
- 2-M16 Grade 8.8 bolts per connection

IMPORTANT

The adequacy of multispan system is very sensitive to actual applied loads. The stated loads in this table are assumed uniform over the full purlin system. Variations in actual project design loadings over the length of the purlin system must be checked specifically by the designer to verify system adequacy.

TWO SPAN CONTINUOUS

LOAD TABLE – Uniformly Distributed Load

MSS 200/18								
SPAN (m)	INWARDS				OUTWARDS			
	$\phi_b w_u$ kN/m			W_s kN/m	$\phi_b w_u$ kN/m			W_s kN/m
	1B	2B	3B		1B	2B	3B	
3.0	12.9	12.9	12.9	40.25	12.9	12.9	12.9	40.25
3.5	9.51	9.51	9.51	25.35	9.51	9.51	9.51	25.35
4.0	7.28	7.28	7.28	16.98	7.28	7.28	7.28	16.98
4.5	5.75	5.75	5.75	11.93	5.75	5.75	5.75	11.93
5.0	4.66	4.66	4.66	8.70	4.66	4.66	4.66	8.70
5.5	3.85	3.85	3.85	6.53	3.85	3.85	3.85	6.53
6.0	3.24	3.24	3.24	5.03	3.24	3.24	3.24	5.03
6.5	2.76	2.76	2.76	3.96	2.76	2.76	2.76	3.96
7.0	2.38	2.38	2.38	3.17	2.38	2.38	2.38	3.17
7.5	2.07	2.07	2.07	2.58	2.07	2.07	2.07	2.58
8.0	1.82	1.82	1.82	2.12	1.82	1.82	1.82	2.12
8.5	1.61	1.61	1.61	1.77	1.61	1.61	1.61	1.77
9.0	1.44	1.44	1.44	1.49	1.44	1.44	1.44	1.49
9.5	1.29	1.29	1.29	1.27	1.27	1.29	1.29	1.27
10.0	1.17	1.17	1.17	1.09	1.11	1.17	1.17	1.09
10.5	1.06	1.06	1.06	0.94	0.98	1.06	1.06	0.94
11.0	0.96	0.96	0.96	0.82	0.86	0.96	0.96	0.82
11.5	0.88	0.88	0.88	0.71	0.75	0.88	0.88	0.71
12.0	0.81	0.81	0.81	0.63	0.66	0.81	0.81	0.63
12.5	0.75	0.75	0.75	0.56	0.58	0.75	0.75	0.56
13.0	0.69	0.69	0.69	0.49	0.51	0.68	0.69	0.49
13.5	0.64	0.64	0.64	0.44	0.45	0.62	0.64	0.44
14.0	0.59	0.59	0.59	0.40	0.39	0.56	0.59	0.40
14.5	0.54	0.55	0.55	0.36	0.34	0.51	0.55	0.36
15.0	0.50	0.52	0.52	0.32	0.30	0.46	0.52	0.32
15.5								
16.0								
16.5								
17.0								
17.5								
18.0								

MSS 200/23								
SPAN (m)	INWARDS				OUTWARDS			
	$\phi_b w_u$ kN/m			W_s kN/m	$\phi_b w_u$ kN/m			W_s kN/m
	1B	2B	3B		1B	2B	3B	
3.0	16.6	16.6	16.6	50.93	16.6	16.6	16.6	50.93
3.5	13.3	13.3	13.3	32.08	13.3	13.3	13.3	32.08
4.0	10.2	10.2	10.2	21.49	10.2	10.2	10.2	21.49
4.5	8.03	8.03	8.03	15.09	8.03	8.03	8.03	15.09
5.0	6.51	6.51	6.51	11.00	6.51	6.51	6.51	11.00
5.5	5.38	5.38	5.38	8.27	5.38	5.38	5.38	8.27
6.0	4.52	4.52	4.52	6.37	4.52	4.52	4.52	6.37
6.5	3.85	3.85	3.85	5.01	3.85	3.85	3.85	5.01
7.0	3.32	3.32	3.32	4.01	3.32	3.32	3.32	4.01
7.5	2.89	2.89	2.89	3.26	2.89	2.89	2.89	3.26
8.0	2.54	2.54	2.54	2.69	2.51	2.54	2.54	2.69
8.5	2.25	2.25	2.25	2.24	2.19	2.25	2.25	2.24
9.0	2.01	2.01	2.01	1.89	1.91	2.01	2.01	1.89
9.5	1.80	1.80	1.80	1.60	1.68	1.80	1.80	1.60
10.0	1.61	1.63	1.63	1.38	1.47	1.63	1.63	1.38
10.5	1.45	1.48	1.48	1.19	1.29	1.48	1.48	1.19
11.0	1.31	1.34	1.34	1.03	1.13	1.33	1.34	1.03
11.5	1.19	1.23	1.23	0.90	0.99	1.21	1.23	0.90
12.0	1.08	1.13	1.13	0.80	0.86	1.09	1.13	0.80
12.5	0.99	1.04	1.04	0.70	0.76	0.99	1.04	0.70
13.0	0.91	0.96	0.96	0.63	0.66	0.90	0.96	0.63
13.5	0.83	0.89	0.89	0.56	0.58	0.82	0.89	0.56
14.0	0.77	0.83	0.83	0.50	0.51	0.74	0.82	0.50
14.5	0.70	0.77	0.77	0.45	0.44	0.67	0.76	0.45
15.0	0.65	0.71	0.72	0.41	0.39	0.61	0.70	0.41
15.5								
16.0								
16.5								
17.0								
17.5								
18.0								

- 1B = One mid span brace
- 2B = Two equally spaced braces within the span
- 3B = Three equally spaced braces within the span
- w_s = Uniformly distributed serviceability load (kN/m) for deflection limit of Span/150
- $\phi_b w_u$ = Strength load resistance applied at the centroid (kN/m)

- 2-M12 Grade 4.6 bolts per connection
- 2-M12 Grade 8.8 bolts per connection
- 2-M16 Grade 4.6 bolts per connection
- 2-M16 Grade 8.8 bolts per connection

IMPORTANT

The adequacy of multispan system is very sensitive to actual applied loads. The stated loads in this table are assumed uniform over the full purlin system. Variations in actual project design loadings over the length of the purlin system must be checked specifically by the designer to verify system adequacy.

TWO SPAN CONTINUOUS

LOAD TABLE – Uniformly Distributed Load

MSS 250/13								
SPAN (m)	INWARDS				OUTWARDS			
	$\phi_b w_u$ kN/m			W_s kN/m	$\phi_b w_u$ kN/m			W_s kN/m
	1B	2B	3B		1B	2B	3B	
3.0								
3.5								
4.0	6.11	6.11	6.11	22.84	6.11	6.11	6.11	22.84
4.5	5.00	5.00	5.00	16.04	5.00	5.00	5.00	16.04
5.0	4.15	4.15	4.15	11.69	4.15	4.15	4.15	11.69
5.5	3.50	3.50	3.50	8.78	3.50	3.50	3.50	8.78
6.0	2.99	2.99	2.99	6.77	2.99	2.99	2.99	6.77
6.5	2.58	2.58	2.58	5.32	2.58	2.58	2.58	5.32
7.0	2.24	2.24	2.24	4.26	2.24	2.24	2.24	4.26
7.5	1.95	1.95	1.95	3.46	1.93	1.95	1.95	3.46
8.0	1.71	1.71	1.71	2.85	1.67	1.71	1.71	2.85
8.5	1.52	1.52	1.52	2.38	1.46	1.52	1.52	2.38
9.0	1.35	1.35	1.35	2.00	1.28	1.35	1.35	2.00
9.5	1.20	1.22	1.22	1.70	1.13	1.22	1.22	1.70
10.0	1.08	1.10	1.10	1.46	1.00	1.10	1.10	1.46
10.5	0.97	0.99	0.99	1.26	0.88	0.98	0.99	1.26
11.0	0.88	0.91	0.91	1.10	0.79	0.89	0.91	1.10
11.5	0.80	0.83	0.83	0.96	0.70	0.80	0.83	0.96
12.0	0.73	0.76	0.76	0.85	0.63	0.73	0.76	0.85
12.5	0.66	0.70	0.70	0.75	0.56	0.66	0.70	0.75
13.0	0.61	0.65	0.65	0.67	0.50	0.60	0.64	0.67
13.5	0.56	0.60	0.60	0.59	0.45	0.55	0.59	0.59
14.0	0.52	0.55	0.56	0.53	0.40	0.51	0.55	0.53
14.5	0.48	0.51	0.52	0.48	0.36	0.46	0.50	0.48
15.0	0.44	0.47	0.49	0.43	0.32	0.43	0.47	0.43
15.5	0.41	0.44	0.46	0.39	0.29	0.39	0.43	0.39
16.0	0.38	0.41	0.43	0.36	0.26	0.36	0.40	0.36
16.5	0.35	0.38	0.40	0.33	0.24	0.33	0.37	0.33
17.0	0.33	0.36	0.38	0.30	0.22	0.31	0.35	0.30
17.5								
18.0								

MSS 250/15								
SPAN (m)	INWARDS				OUTWARDS			
	$\phi_b w_u$ kN/m			W_s kN/m	$\phi_b w_u$ kN/m			W_s kN/m
	1B	2B	3B		1B	2B	3B	
3.0								
3.5								
4.0	7.98	7.98	7.98	26.34	7.98	7.98	7.98	26.34
4.5	6.49	6.49	6.49	18.50	6.49	6.49	6.49	18.50
5.0	5.37	5.37	5.37	13.49	5.37	5.37	5.37	13.49
5.5	4.45	4.45	4.45	10.13	4.45	4.45	4.45	10.13
6.0	3.74	3.74	3.74	7.80	3.74	3.74	3.74	7.80
6.5	3.19	3.19	3.19	6.14	3.19	3.19	3.19	6.14
7.0	2.75	2.75	2.75	4.91	2.75	2.75	2.75	4.91
7.5	2.40	2.40	2.40	4.00	2.40	2.40	2.40	4.00
8.0	2.11	2.11	2.11	3.29	2.11	2.11	2.11	3.29
8.5	1.87	1.87	1.87	2.74	1.84	1.87	1.87	2.74
9.0	1.66	1.66	1.66	2.31	1.61	1.66	1.66	2.31
9.5	1.49	1.49	1.49	1.97	1.42	1.49	1.49	1.97
10.0	1.35	1.35	1.35	1.69	1.26	1.35	1.35	1.69
10.5	1.21	1.22	1.22	1.46	1.12	1.22	1.22	1.46
11.0	1.10	1.11	1.11	1.27	0.99	1.11	1.11	1.27
11.5	1.00	1.02	1.02	1.11	0.89	1.01	1.02	1.11
12.0	0.91	0.94	0.94	0.98	0.79	0.92	0.94	0.98
12.5	0.83	0.86	0.86	0.86	0.71	0.84	0.86	0.86
13.0	0.76	0.80	0.80	0.77	0.64	0.76	0.80	0.77
13.5	0.70	0.74	0.74	0.69	0.57	0.70	0.74	0.69
14.0	0.64	0.69	0.69	0.61	0.51	0.64	0.69	0.61
14.5	0.60	0.64	0.64	0.55	0.46	0.59	0.64	0.55
15.0	0.55	0.60	0.60	0.50	0.41	0.54	0.59	0.50
15.5	0.51	0.55	0.56	0.45	0.37	0.50	0.55	0.45
16.0	0.47	0.52	0.53	0.41	0.33	0.46	0.51	0.41
16.5	0.44	0.48	0.49	0.38	0.30	0.42	0.47	0.38
17.0	0.41	0.45	0.47	0.34	0.27	0.39	0.44	0.34
17.5								
18.0								

- 1B = One mid span brace
- 2B = Two equally spaced braces within the span
- 3B = Three equally spaced braces within the span
- w_s = Uniformly distributed serviceability load (kN/m) for deflection limit of Span/150
- $\phi_b w_u$ = Strength load resistance applied at the centroid (kN/m)

- 2-M12 Grade 4.6 bolts per connection
- 2-M12 Grade 8.8 bolts per connection
- 2-M16 Grade 4.6 bolts per connection
- 2-M16 Grade 8.8 bolts per connection

IMPORTANT

The adequacy of multispan system is very sensitive to actual applied loads. The stated loads in this table are assumed uniform over the full purlin system. Variations in actual project design loadings over the length of the purlin system must be checked specifically by the designer to verify system adequacy.

TWO SPAN CONTINUOUS

LOAD TABLE – Uniformly Distributed Load

MSS 250/18								
SPAN (m)	INWARDS				OUTWARDS			
	$\phi_b w_u$ kN/m			W_s kN/m	$\phi_b w_u$ kN/m			W_s kN/m
	1B	2B	3B		1B	2B	3B	
3.0								
3.5								
4.0	9.68	9.68	9.68	31.58	9.68	9.68	9.68	31.58
4.5	8.08	8.08	8.08	22.18	8.08	8.08	8.08	22.18
5.0	6.54	6.54	6.54	16.17	6.54	6.54	6.54	16.17
5.5	5.41	5.41	5.41	12.15	5.41	5.41	5.41	12.15
6.0	4.54	4.54	4.54	9.36	4.54	4.54	4.54	9.36
6.5	3.87	3.87	3.87	7.36	3.87	3.87	3.87	7.36
7.0	3.34	3.34	3.34	5.89	3.34	3.34	3.34	5.89
7.5	2.91	2.91	2.91	4.79	2.91	2.91	2.91	4.79
8.0	2.56	2.56	2.56	3.95	2.56	2.56	2.56	3.95
8.5	2.26	2.26	2.26	3.29	2.26	2.26	2.26	3.29
9.0	2.02	2.02	2.02	2.77	2.02	2.02	2.02	2.77
9.5	1.81	1.81	1.81	2.36	1.81	1.81	1.81	2.36
10.0	1.64	1.64	1.64	2.02	1.63	1.64	1.64	2.02
10.5	1.48	1.48	1.48	1.75	1.46	1.48	1.48	1.75
11.0	1.35	1.35	1.35	1.52	1.30	1.35	1.35	1.52
11.5	1.24	1.24	1.24	1.33	1.17	1.24	1.24	1.33
12.0	1.14	1.14	1.14	1.17	1.05	1.14	1.14	1.17
12.5	1.05	1.05	1.05	1.03	0.94	1.05	1.05	1.03
13.0	0.97	0.97	0.97	0.92	0.84	0.97	0.97	0.92
13.5	0.90	0.90	0.90	0.82	0.75	0.90	0.90	0.82
14.0	0.83	0.83	0.83	0.74	0.67	0.83	0.83	0.74
14.5	0.77	0.78	0.78	0.66	0.60	0.76	0.78	0.66
15.0	0.71	0.73	0.73	0.60	0.54	0.70	0.73	0.60
15.5	0.66	0.68	0.68	0.54	0.48	0.65	0.68	0.54
16.0	0.61	0.64	0.64	0.49	0.43	0.60	0.64	0.49
16.5	0.57	0.60	0.60	0.45	0.38	0.56	0.60	0.45
17.0	0.53	0.57	0.57	0.41	0.34	0.52	0.57	0.41
17.5								
18.0								

MSS 250/23								
SPAN (m)	INWARDS				OUTWARDS			
	$\phi_b w_u$ kN/m			W_s kN/m	$\phi_b w_u$ kN/m			W_s kN/m
	1B	2B	3B		1B	2B	3B	
3.0								
3.5								
4.0	12.4	12.4	12.4	40.13	12.4	12.4	12.4	40.13
4.5	11.1	11.1	11.1	28.18	11.1	11.1	11.1	28.18
5.0	9.17	9.17	9.17	20.54	9.2	9.2	9.2	20.54
5.5	7.58	7.58	7.58	15.44	7.58	7.58	7.58	15.44
6.0	6.37	6.37	6.37	11.89	6.37	6.37	6.37	11.89
6.5	5.43	5.43	5.43	9.35	5.43	5.43	5.43	9.35
7.0	4.68	4.68	4.68	7.49	4.68	4.68	4.68	7.49
7.5	4.08	4.08	4.08	6.09	4.08	4.08	4.08	6.09
8.0	3.58	3.58	3.58	5.02	3.58	3.58	3.58	5.02
8.5	3.17	3.17	3.17	4.18	3.17	3.17	3.17	4.18
9.0	2.83	2.83	2.83	3.52	2.83	2.83	2.83	3.52
9.5	2.54	2.54	2.54	3.00	2.54	2.54	2.54	3.00
10.0	2.29	2.29	2.29	2.57	2.29	2.29	2.29	2.57
10.5	2.08	2.08	2.08	2.22	2.06	2.08	2.08	2.22
11.0	1.90	1.90	1.90	1.93	1.83	1.90	1.90	1.93
11.5	1.73	1.73	1.73	1.69	1.63	1.73	1.73	1.69
12.0	1.59	1.59	1.59	1.49	1.45	1.59	1.59	1.49
12.5	1.47	1.47	1.47	1.31	1.29	1.47	1.47	1.31
13.0	1.36	1.36	1.36	1.17	1.15	1.36	1.36	1.17
13.5	1.25	1.26	1.26	1.04	1.03	1.26	1.26	1.04
14.0	1.15	1.17	1.17	0.94	0.91	1.17	1.17	0.94
14.5	1.06	1.09	1.09	0.84	0.81	1.09	1.09	0.84
15.0	0.98	1.02	1.02	0.76	0.72	0.99	1.02	0.76
15.5	0.91	0.95	0.95	0.69	0.64	0.91	0.95	0.69
16.0	0.84	0.90	0.90	0.63	0.57	0.84	0.90	0.63
16.5	0.78	0.84	0.84	0.57	0.50	0.77	0.84	0.57
17.0	0.72	0.79	0.79	0.52	0.45	0.71	0.79	0.52
17.5								
18.0								

- 1B = One mid span brace
- 2B = Two equally spaced braces within the span
- 3B = Three equally spaced braces within the span
- w_s = Uniformly distributed serviceability load (kN/m) for deflection limit of Span/150
- $\phi_b w_u$ = Strength load resistance applied at the centroid (kN/m)

- 2-M12 Grade 4.6 bolts per connection
- 2-M12 Grade 8.8 bolts per connection
- 2-M16 Grade 4.6 bolts per connection
- 2-M16 Grade 8.8 bolts per connection

IMPORTANT

The adequacy of multispan system is very sensitive to actual applied loads. The stated loads in this table are assumed uniform over the full purlin system. Variations in actual project design loadings over the length of the purlin system must be checked specifically by the designer to verify system adequacy.

TWO SPAN CONTINUOUS

LOAD TABLE – Uniformly Distributed Load

MSS 275/15								
SPAN (m)	INWARDS				OUTWARDS			
	$\phi_b w_u$ kN/m			W_s kN/m	$\phi_b w_u$ kN/m			W_s kN/m
	1B	2B	3B		1B	2B	3B	
3.0								
3.5								
4.0								
4.5	6.60	6.60	6.60	23.94	6.60	6.60	6.60	23.94
5.0	5.54	5.54	5.54	17.45	5.54	5.54	5.54	17.45
5.5	4.70	4.70	4.70	13.11	4.70	4.70	4.70	13.11
6.0	4.04	4.04	4.04	10.10	4.04	4.04	4.04	10.10
6.5	3.51	3.51	3.51	7.94	3.51	3.51	3.51	7.94
7.0	3.07	3.07	3.07	6.36	3.07	3.07	3.07	6.36
7.5	2.68	2.68	2.68	5.17	2.68	2.68	2.68	5.17
8.0	2.36	2.36	2.36	4.26	2.36	2.36	2.36	4.26
8.5	2.09	2.09	2.09	3.55	2.09	2.09	2.09	3.55
9.0	1.86	1.86	1.86	2.99	1.82	1.86	1.86	2.99
9.5	1.67	1.67	1.67	2.54	1.61	1.67	1.67	2.54
10.0	1.50	1.51	1.51	2.18	1.42	1.51	1.51	2.18
10.5	1.35	1.37	1.37	1.88	1.27	1.37	1.37	1.88
11.0	1.23	1.25	1.25	1.64	1.13	1.25	1.25	1.64
11.5	1.11	1.14	1.14	1.43	1.01	1.14	1.14	1.43
12.0	1.02	1.05	1.05	1.26	0.90	1.04	1.05	1.26
12.5	0.93	0.97	0.97	1.12	0.81	0.94	0.97	1.12
13.0	0.85	0.89	0.89	0.99	0.73	0.86	0.89	0.99
13.5	0.78	0.83	0.83	0.89	0.66	0.79	0.83	0.89
14.0	0.72	0.77	0.77	0.79	0.59	0.72	0.77	0.79
14.5	0.67	0.72	0.72	0.72	0.53	0.66	0.72	0.72
15.0	0.62	0.67	0.67	0.65	0.48	0.61	0.66	0.65
15.5	0.57	0.62	0.63	0.59	0.43	0.56	0.62	0.59
16.0	0.53	0.58	0.59	0.53	0.39	0.52	0.57	0.53
16.5	0.50	0.54	0.55	0.49	0.35	0.48	0.53	0.49
17.0	0.46	0.50	0.52	0.44	0.32	0.44	0.50	0.44
17.5								
18.0								

MSS 275/18								
SPAN (m)	INWARDS				OUTWARDS			
	$\phi_b w_u$ kN/m			W_s kN/m	$\phi_b w_u$ kN/m			W_s kN/m
	1B	2B	3B		1B	2B	3B	
3.0								
3.5								
4.0								
4.5	8.60	8.60	8.60	28.70	8.60	8.60	8.60	28.70
5.0	7.34	7.34	7.34	20.92	7.34	7.34	7.34	20.92
5.5	6.06	6.06	6.06	15.72	6.06	6.06	6.06	15.72
6.0	5.09	5.09	5.09	12.11	5.09	5.09	5.09	12.11
6.5	4.34	4.34	4.34	9.52	4.34	4.34	4.34	9.52
7.0	3.74	3.74	3.74	7.62	3.74	3.74	3.74	7.62
7.5	3.26	3.26	3.26	6.20	3.26	3.26	3.26	6.20
8.0	2.87	2.87	2.87	5.11	2.87	2.87	2.87	5.11
8.5	2.54	2.54	2.54	4.26	2.54	2.54	2.54	4.26
9.0	2.26	2.26	2.26	3.59	2.26	2.26	2.26	3.59
9.5	2.03	2.03	2.03	3.05	2.03	2.03	2.03	3.05
10.0	1.83	1.83	1.83	2.61	1.83	1.83	1.83	2.61
10.5	1.66	1.66	1.66	2.26	1.64	1.66	1.66	2.26
11.0	1.52	1.52	1.52	1.96	1.47	1.52	1.52	1.96
11.5	1.39	1.39	1.39	1.72	1.32	1.39	1.39	1.72
12.0	1.27	1.27	1.27	1.51	1.19	1.27	1.27	1.51
12.5	1.17	1.17	1.17	1.34	1.07	1.17	1.17	1.34
13.0	1.09	1.09	1.09	1.19	0.97	1.09	1.09	1.19
13.5	1.00	1.01	1.01	1.06	0.87	1.01	1.01	1.06
14.0	0.92	0.94	0.94	0.95	0.79	0.94	0.94	0.95
14.5	0.85	0.87	0.87	0.86	0.72	0.86	0.87	0.86
15.0	0.79	0.82	0.82	0.77	0.65	0.80	0.82	0.77
15.5	0.74	0.76	0.76	0.70	0.58	0.74	0.76	0.70
16.0	0.68	0.72	0.72	0.64	0.52	0.68	0.72	0.64
16.5	0.64	0.67	0.67	0.58	0.47	0.63	0.67	0.58
17.0	0.60	0.63	0.63	0.53	0.42	0.58	0.63	0.53
17.5								
18.0								

- 1B = One mid span brace
- 2B = Two equally spaced braces within the span
- 3B = Three equally spaced braces within the span
- w_s = Uniformly distributed serviceability load (kN/m) for deflection limit of Span/150
- $\phi_b w_u$ = Strength load resistance applied at the centroid (kN/m)

- 2-M12 Grade 4.6 bolts per connection
- 2-M12 Grade 8.8 bolts per connection
- 2-M16 Grade 4.6 bolts per connection
- 2-M16 Grade 8.8 bolts per connection

IMPORTANT

The adequacy of multispan system is very sensitive to actual applied loads. The stated loads in this table are assumed uniform over the full purlin system. Variations in actual project design loadings over the length of the purlin system must be checked specifically by the designer to verify system adequacy.

TWO SPAN CONTINUOUS

LOAD TABLE – Uniformly Distributed Load

MSS 300/15								
SPAN (m)	INWARDS				OUTWARDS			
	$\phi_b w_u$ kN/m			w_s kN/m	$\phi_b w_u$ kN/m			w_s kN/m
	1B	2B	3B		1B	2B	3B	
3.0								
3.5								
4.0								
4.5								
5.0	5.76	5.76	5.76	22.95	5.76	5.76	5.76	22.95
5.5	4.95	4.95	4.95	17.24	4.95	4.95	4.95	17.24
6.0	4.28	4.28	4.28	13.28	4.28	4.28	4.28	13.28
6.5	3.74	3.74	3.74	10.45	3.74	3.74	3.74	10.45
7.0	3.30	3.30	3.30	8.36	3.30	3.30	3.30	8.36
7.5	2.92	2.92	2.92	6.80	2.92	2.92	2.92	6.80
8.0	2.61	2.61	2.61	5.60	2.61	2.61	2.61	5.60
8.5	2.34	2.34	2.34	4.67	2.34	2.34	2.34	4.67
9.0	2.11	2.11	2.11	3.94	2.11	2.11	2.11	3.94
9.5	1.91	1.91	1.91	3.35	1.91	1.91	1.91	3.35
10.0	1.74	1.74	1.74	2.87	1.70	1.74	1.74	2.87
10.5	1.57	1.58	1.58	2.48	1.52	1.58	1.58	2.48
11.0	1.43	1.44	1.44	2.16	1.36	1.44	1.44	2.16
11.5	1.30	1.32	1.32	1.89	1.22	1.32	1.32	1.89
12.0	1.18	1.21	1.21	1.66	1.10	1.21	1.21	1.66
12.5	1.08	1.12	1.12	1.47	1.00	1.11	1.12	1.47
13.0	0.99	1.03	1.03	1.31	0.90	1.02	1.03	1.31
13.5	0.91	0.96	0.96	1.17	0.82	0.94	0.96	1.17
14.0	0.84	0.89	0.89	1.05	0.74	0.87	0.89	1.05
14.5	0.78	0.83	0.83	0.94	0.67	0.80	0.83	0.94
15.0	0.72	0.77	0.77	0.85	0.61	0.74	0.77	0.85
15.5	0.67	0.73	0.73	0.77	0.56	0.68	0.73	0.77
16.0	0.63	0.68	0.68	0.70	0.50	0.63	0.68	0.70
16.5	0.58	0.64	0.64	0.64	0.46	0.59	0.63	0.64
17.0	0.55	0.60	0.60	0.58	0.42	0.54	0.59	0.58
17.5	0.51	0.56	0.57	0.54	0.38	0.51	0.55	0.54
18.0	0.48	0.52	0.54	0.49	0.34	0.47	0.52	0.49

MSS 300/18								
SPAN (m)	INWARDS				OUTWARDS			
	$\phi_b w_u$ kN/m			w_s kN/m	$\phi_b w_u$ kN/m			w_s kN/m
	1B	2B	3B		1B	2B	3B	
3.0								
3.5								
4.0								
4.5								
5.0	7.74	7.74	7.74	27.52	7.74	7.74	7.74	27.52
5.5	6.77	6.77	6.77	20.68	6.77	6.77	6.77	20.68
6.0	5.83	5.83	5.83	15.93	5.83	5.83	5.83	15.93
6.5	5.03	5.03	5.03	12.53	5.03	5.03	5.03	12.53
7.0	4.34	4.34	4.34	10.03	4.34	4.34	4.34	10.03
7.5	3.78	3.78	3.78	8.16	3.78	3.78	3.78	8.16
8.0	3.32	3.32	3.32	6.72	3.32	3.32	3.32	6.72
8.5	2.94	2.94	2.94	5.60	2.94	2.94	2.94	5.60
9.0	2.62	2.62	2.62	4.72	2.62	2.62	2.62	4.72
9.5	2.35	2.35	2.35	4.01	2.35	2.35	2.35	4.01
10.0	2.12	2.12	2.12	3.44	2.12	2.12	2.12	3.44
10.5	1.93	1.93	1.93	2.97	1.93	1.93	1.93	2.97
11.0	1.76	1.76	1.76	2.58	1.75	1.76	1.76	2.58
11.5	1.61	1.61	1.61	2.26	1.58	1.61	1.61	2.26
12.0	1.48	1.48	1.48	1.99	1.43	1.48	1.48	1.99
12.5	1.36	1.36	1.36	1.76	1.29	1.36	1.36	1.76
13.0	1.26	1.26	1.26	1.57	1.17	1.26	1.26	1.57
13.5	1.16	1.17	1.17	1.40	1.07	1.17	1.17	1.40
14.0	1.07	1.08	1.08	1.25	0.97	1.08	1.08	1.25
14.5	0.99	1.01	1.01	1.13	0.89	1.01	1.01	1.13
15.0	0.92	0.94	0.94	1.02	0.81	0.94	0.94	1.02
15.5	0.86	0.88	0.88	0.92	0.74	0.88	0.88	0.92
16.0	0.80	0.83	0.83	0.84	0.67	0.81	0.83	0.84
16.5	0.75	0.78	0.78	0.77	0.61	0.76	0.78	0.77
17.0	0.70	0.74	0.74	0.70	0.56	0.70	0.74	0.70
17.5	0.65	0.69	0.69	0.64	0.51	0.66	0.69	0.64
18.0	0.61	0.66	0.66	0.59	0.47	0.61	0.66	0.59

- 1B = One mid span brace
- 2B = Two equally spaced braces within the span
- 3B = Three equally spaced braces within the span
- w_s = Uniformly distributed serviceability load (kN/m) for deflection limit of Span/150
- $\phi_b w_u$ = Strength load resistance applied at the centroid (kN/m)

- 2-M12 Grade 4.6 bolts per connection
- 2-M12 Grade 8.8 bolts per connection
- 2-M16 Grade 4.6 bolts per connection
- 2-M16 Grade 8.8 bolts per connection

IMPORTANT

The adequacy of multispan system is very sensitive to actual applied loads. The stated loads in this table are assumed uniform over the full purlin system. Variations in actual project design loadings over the length of the purlin system must be checked specifically by the designer to verify system adequacy.

TWO SPAN CONTINUOUS

LOAD TABLE – Uniformly Distributed Load

MSS 300/23								
SPAN (m)	INWARDS				OUTWARDS			
	$\phi_b w_u$ kN/m			W_s kN/m	$\phi_b w_u$ kN/m			W_s kN/m
	1B	2B	3B		1B	2B	3B	
3.0								
3.5								
4.0								
4.5								
5.0	9.95	9.95	9.95	35.02	9.95	9.95	9.95	35.02
5.5	9.05	9.05	9.05	26.31	9.05	9.05	9.05	26.31
6.0	8.29	8.30	8.29	20.26	8.29	8.30	8.29	20.26
6.5	7.09	7.09	7.09	15.94	7.09	7.09	7.09	15.94
7.0	6.12	6.12	6.12	12.76	6.12	6.12	6.12	12.76
7.5	5.33	5.33	5.33	10.38	5.33	5.33	5.33	10.38
8.0	4.68	4.68	4.68	8.55	4.68	4.68	4.68	8.55
8.5	4.15	4.15	4.15	7.13	4.15	4.15	4.15	7.13
9.0	3.70	3.70	3.70	6.00	3.70	3.70	3.70	6.00
9.5	3.32	3.32	3.32	5.11	3.32	3.32	3.32	5.11
10.0	3.00	3.00	3.00	4.38	3.00	3.00	3.00	4.38
10.5	2.72	2.72	2.72	3.78	2.72	2.72	2.72	3.78
11.0	2.48	2.48	2.48	3.29	2.48	2.48	2.48	3.29
11.5	2.27	2.27	2.27	2.88	2.27	2.27	2.27	2.88
12.0	2.08	2.08	2.08	2.53	2.08	2.08	2.08	2.53
12.5	1.92	1.92	1.92	2.24	1.92	1.92	1.92	2.24
13.0	1.77	1.77	1.77	1.99	1.75	1.77	1.77	1.99
13.5	1.65	1.65	1.65	1.78	1.58	1.65	1.65	1.78
14.0	1.53	1.53	1.53	1.60	1.43	1.53	1.53	1.60
14.5	1.43	1.43	1.43	1.44	1.30	1.43	1.43	1.44
15.0	1.33	1.33	1.33	1.30	1.17	1.33	1.33	1.30
15.5	1.25	1.25	1.25	1.18	1.06	1.25	1.25	1.18
16.0	1.17	1.17	1.17	1.07	0.96	1.17	1.17	1.07
16.5	1.09	1.10	1.10	0.97	0.87	1.10	1.10	0.97
17.0	1.01	1.04	1.04	0.89	0.79	1.04	1.04	0.89
17.5	0.95	0.98	0.98	0.82	0.71	0.98	0.98	0.82
18.0	0.88	0.93	0.93	0.75	0.64	0.91	0.93	0.75

MSS 300/24								
SPAN (m)	INWARDS				OUTWARDS			
	$\phi_b w_u$ kN/m			W_s kN/m	$\phi_b w_u$ kN/m			W_s kN/m
	1B	2B	3B		1B	2B	3B	
3.0								
3.5								
4.0								
4.5								
5.0	10.6	10.6	10.6	37.26	10.6	10.6	10.6	37.26
5.5	9.65	9.65	9.65	28.00	9.65	9.65	9.65	28.00
6.0	8.85	8.85	8.85	21.57	8.85	8.85	8.85	21.57
6.5	7.76	7.76	7.76	16.96	7.76	7.76	7.76	16.96
7.0	6.69	6.69	6.69	13.58	6.69	6.69	6.69	13.58
7.5	5.83	5.83	5.83	11.04	5.83	5.83	5.83	11.04
8.0	5.12	5.12	5.12	9.10	5.12	5.12	5.12	9.10
8.5	4.54	4.54	4.54	7.58	4.54	4.54	4.54	7.58
9.0	4.05	4.05	4.05	6.39	4.05	4.05	4.05	6.39
9.5	3.63	3.63	3.63	5.43	3.63	3.63	3.63	5.43
10.0	3.28	3.28	3.28	4.66	3.28	3.28	3.28	4.66
10.5	2.98	2.98	2.98	4.02	2.98	2.98	2.98	4.02
11.0	2.71	2.71	2.71	3.50	2.71	2.71	2.71	3.50
11.5	2.48	2.48	2.48	3.06	2.48	2.48	2.48	3.06
12.0	2.28	2.28	2.28	2.70	2.28	2.28	2.28	2.70
12.5	2.10	2.10	2.10	2.38	2.09	2.10	2.10	2.38
13.0	1.94	1.94	1.94	2.12	1.89	1.94	1.94	2.12
13.5	1.80	1.80	1.80	1.89	1.71	1.80	1.80	1.89
14.0	1.67	1.67	1.67	1.70	1.55	1.67	1.67	1.70
14.5	1.56	1.56	1.56	1.53	1.40	1.56	1.56	1.53
15.0	1.46	1.46	1.46	1.38	1.27	1.46	1.46	1.38
15.5	1.35	1.37	1.37	1.25	1.15	1.37	1.37	1.25
16.0	1.25	1.28	1.28	1.14	1.04	1.28	1.28	1.14
16.5	1.17	1.21	1.21	1.04	0.94	1.21	1.21	1.04
17.0	1.09	1.14	1.14	0.95	0.85	1.14	1.14	0.95
17.5	1.01	1.07	1.07	0.87	0.77	1.06	1.07	0.87
18.0	0.95	1.01	1.01	0.87	0.70	0.99	1.01	0.87

- 1B = One mid span brace
- 2B = Two equally spaced braces within the span
- 3B = Three equally spaced braces within the span
- w_s = Uniformly distributed serviceability load (kN/m) for deflection limit of Span/150
- $\phi_b w_u$ = Strength load resistance applied at the centroid (kN/m)

- 2-M12 Grade 4.6 bolts per connection
- 2-M12 Grade 8.8 bolts per connection
- 2-M16 Grade 4.6 bolts per connection
- 2-M16 Grade 8.8 bolts per connection

IMPORTANT

The adequacy of multispan system is very sensitive to actual applied loads. The stated loads in this table are assumed uniform over the full purlin system. Variations in actual project design loadings over the length of the purlin system must be checked specifically by the designer to verify system adequacy.

TWO SPAN CONTINUOUS

LOAD TABLE – Uniformly Distributed Load

MSS 300/30								
SPAN (m)	INWARDS				OUTWARDS			
	$\phi_b w_u$ kN/m			w_s kN/m	$\phi_b w_u$ kN/m			w_s kN/m
	1B	2B	3B		1B	2B	3B	
3.0								
3.5								
4.0								
4.5								
5.0	13.1	13.1	13.1	45.29	13.1	13.1	13.1	45.29
5.5	11.9	11.9	11.9	34.03	11.9	11.9	11.9	34.03
6.0	10.9	10.9	10.9	26.21	10.9	10.9	10.9	26.21
6.5	10.0	10.0	10.0	20.61	10.0	10.0	10.0	20.61
7.0	8.80	8.80	8.80	16.50	8.80	8.80	8.80	16.50
7.5	7.66	7.66	7.66	13.42	7.66	7.66	7.66	13.42
8.0	6.74	6.74	6.74	11.06	6.74	6.74	6.74	11.06
8.5	5.97	5.97	5.97	9.22	5.97	5.97	5.97	9.22
9.0	5.32	5.32	5.32	7.77	5.32	5.32	5.32	7.77
9.5	4.78	4.78	4.78	6.60	4.78	4.78	4.78	6.60
10.0	4.31	4.31	4.31	5.66	4.31	4.31	4.31	5.66
10.5	3.91	3.91	3.91	4.89	3.91	3.91	3.91	4.89
11.0	3.56	3.56	3.56	4.25	3.56	3.56	3.56	4.25
11.5	3.26	3.26	3.26	3.72	3.26	3.26	3.26	3.72
12.0	2.99	2.99	2.99	3.28	2.97	2.99	2.99	3.28
12.5	2.76	2.76	2.76	2.90	2.67	2.76	2.76	2.90
13.0	2.53	2.55	2.55	2.58	2.40	2.55	2.55	2.58
13.5	2.32	2.37	2.37	2.30	2.16	2.37	2.37	2.30
14.0	2.13	2.20	2.20	2.06	1.95	2.20	2.20	2.06
14.5	1.96	2.05	2.05	1.86	1.76	2.05	2.05	1.86
15.0	1.81	1.92	1.92	1.68	1.59	1.92	1.92	1.68
15.5	1.67	1.79	1.79	1.52	1.44	1.79	1.79	1.52
16.0	1.55	1.68	1.68	1.38	1.30	1.68	1.68	1.38
16.5	1.43	1.58	1.58	1.26	1.17	1.58	1.58	1.26
17.0	1.33	1.49	1.49	1.15	1.06	1.46	1.49	1.15
17.5	1.24	1.41	1.41	1.06	0.95	1.36	1.41	1.06
18.0	1.16	1.33	1.33	0.97	0.86	1.26	1.33	0.97

MSS 325/15								
SPAN (m)	INWARDS				OUTWARDS			
	$\phi_b w_u$ kN/m			w_s kN/m	$\phi_b w_u$ kN/m			w_s kN/m
	1B	2B	3B		1B	2B	3B	
3.0								
3.5								
4.0								
4.5								
5.0	5.98	5.98	5.98	27.70	5.98	5.98	5.98	27.70
5.5	5.16	5.16	5.16	20.81	5.16	5.16	5.16	20.81
6.0	4.49	4.49	4.49	16.03	4.49	4.49	4.49	16.03
6.5	3.94	3.94	3.94	12.61	3.94	3.94	3.94	12.61
7.0	3.48	3.48	3.48	10.10	3.48	3.48	3.48	10.10
7.5	3.09	3.09	3.09	8.21	3.09	3.09	3.09	8.21
8.0	2.77	2.77	2.77	6.76	2.77	2.77	2.77	6.76
8.5	2.49	2.49	2.49	5.64	2.49	2.49	2.49	5.64
9.0	2.25	2.25	2.25	4.75	2.25	2.25	2.25	4.75
9.5	2.04	2.04	2.04	4.04	2.04	2.04	2.04	4.04
10.0	1.86	1.86	1.86	3.46	1.85	1.86	1.86	3.46
10.5	1.70	1.70	1.70	2.99	1.65	1.70	1.70	2.99
11.0	1.55	1.56	1.56	2.60	1.48	1.56	1.56	2.60
11.5	1.41	1.43	1.43	2.28	1.33	1.43	1.43	2.28
12.0	1.29	1.31	1.31	2.00	1.20	1.31	1.31	2.00
12.5	1.18	1.21	1.21	1.77	1.08	1.21	1.21	1.77
13.0	1.08	1.12	1.12	1.58	0.98	1.11	1.12	1.58
13.5	0.99	1.04	1.04	1.41	0.89	1.02	1.04	1.41
14.0	0.92	0.96	0.96	1.26	0.80	0.94	0.96	1.26
14.5	0.85	0.90	0.90	1.14	0.73	0.87	0.90	1.14
15.0	0.79	0.84	0.84	1.03	0.66	0.80	0.84	1.03
15.5	0.73	0.79	0.79	0.93	0.60	0.74	0.79	0.93
16.0	0.68	0.74	0.74	0.85	0.55	0.69	0.74	0.85
16.5	0.63	0.69	0.69	0.77	0.49	0.64	0.69	0.77
17.0	0.59	0.65	0.65	0.70	0.45	0.59	0.64	0.70
17.5	0.55	0.61	0.62	0.65	0.41	0.55	0.60	0.65
18.0	0.52	0.57	0.58	0.59	0.37	0.51	0.56	0.59

- 1B = One mid span brace
- 2B = Two equally spaced braces within the span
- 3B = Three equally spaced braces within the span
- w_s = Uniformly distributed serviceability load (kN/m) for deflection limit of Span/150
- $\phi_b w_u$ = Strength load resistance applied at the centroid (kN/m)

- 2-M12 Grade 4.6 bolts per connection
- 2-M12 Grade 8.8 bolts per connection
- 2-M16 Grade 4.6 bolts per connection
- 2-M16 Grade 8.8 bolts per connection

IMPORTANT

The adequacy of multispan system is very sensitive to actual applied loads. The stated loads in this table are assumed uniform over the full purlin system. Variations in actual project design loadings over the length of the purlin system must be checked specifically by the designer to verify system adequacy.

TWO SPAN CONTINUOUS

LOAD TABLE – Uniformly Distributed Load

MSS 325/18								
SPAN (m)	INWARDS				OUTWARDS			
	$\phi_b w_u$ kN/m			W_s kN/m	$\phi_b w_u$ kN/m			W_s kN/m
	1B	2B	3B		1B	2B	3B	
3.0								
3.5								
4.0								
4.5								
5.0	7.74	7.74	7.74	33.24	7.74	7.74	7.74	33.24
5.5	7.04	7.04	7.04	24.98	7.04	7.04	7.04	24.98
6.0	6.15	6.15	6.15	19.24	6.15	6.15	6.15	19.24
6.5	5.36	5.36	5.36	15.13	5.36	5.36	5.36	15.13
7.0	4.71	4.71	4.71	12.11	4.71	4.71	4.71	12.11
7.5	4.10	4.10	4.10	9.85	4.10	4.10	4.10	9.85
8.0	3.61	3.61	3.61	8.12	3.61	3.61	3.61	8.12
8.5	3.19	3.19	3.19	6.77	3.19	3.19	3.19	6.77
9.0	2.85	2.85	2.85	5.70	2.85	2.85	2.85	5.70
9.5	2.56	2.56	2.56	4.85	2.56	2.56	2.56	4.85
10.0	2.31	2.31	2.31	4.16	2.31	2.31	2.31	4.16
10.5	2.09	2.09	2.09	3.59	2.09	2.09	2.09	3.59
11.0	1.91	1.91	1.91	3.12	1.90	1.91	1.91	3.12
11.5	1.75	1.75	1.75	2.73	1.71	1.75	1.75	2.73
12.0	1.60	1.60	1.60	2.40	1.55	1.60	1.60	2.40
12.5	1.48	1.48	1.48	2.13	1.40	1.48	1.48	2.13
13.0	1.37	1.37	1.37	1.89	1.27	1.37	1.37	1.89
13.5	1.26	1.27	1.27	1.69	1.16	1.27	1.27	1.69
14.0	1.16	1.18	1.18	1.51	1.05	1.18	1.18	1.51
14.5	1.08	1.10	1.10	1.36	0.96	1.10	1.10	1.36
15.0	1.00	1.03	1.03	1.23	0.87	1.03	1.03	1.23
15.5	0.93	0.96	0.96	1.12	0.80	0.95	0.96	1.12
16.0	0.86	0.90	0.90	1.01	0.73	0.88	0.90	1.01
16.5	0.81	0.85	0.85	0.93	0.66	0.82	0.85	0.93
17.0	0.75	0.80	0.80	0.85	0.60	0.76	0.80	0.85
17.5	0.71	0.75	0.75	0.78	0.55	0.71	0.75	0.78
18.0	0.66	0.71	0.71	0.71	0.50	0.66	0.71	0.71

MSS 350/18								
SPAN (m)	INWARDS				OUTWARDS			
	$\phi_b w_u$ kN/m			W_s kN/m	$\phi_b w_u$ kN/m			W_s kN/m
	1B	2B	3B		1B	2B	3B	
3.0								
3.5								
4.0								
4.5								
5.0								
5.5								
6.0	6.10	6.10	6.10	23.29	6.10	6.10	6.10	23.29
6.5	5.36	5.36	5.36	18.32	5.36	5.36	5.36	18.32
7.0	4.75	4.75	4.75	14.67	4.75	4.75	4.75	14.67
7.5	4.23	4.23	4.23	11.92	4.23	4.23	4.23	11.92
8.0	3.79	3.79	3.79	9.82	3.79	3.79	3.79	9.82
8.5	3.41	3.41	3.41	8.19	3.41	3.41	3.41	8.19
9.0	3.08	3.08	3.08	6.90	3.08	3.08	3.08	6.90
9.5	2.80	2.80	2.80	5.87	2.80	2.80	2.80	5.87
10.0	2.56	2.56	2.56	5.03	2.56	2.56	2.56	5.03
10.5	2.34	2.34	2.34	4.35	2.34	2.34	2.34	4.35
11.0	2.13	2.13	2.13	3.78	2.12	2.13	2.13	3.78
11.5	1.95	1.95	1.95	3.31	1.91	1.95	1.95	3.31
12.0	1.79	1.79	1.79	2.91	1.73	1.79	1.79	2.91
12.5	1.64	1.65	1.65	2.58	1.57	1.65	1.65	2.58
13.0	1.51	1.53	1.53	2.29	1.42	1.53	1.53	2.29
13.5	1.40	1.42	1.42	2.04	1.29	1.42	1.42	2.04
14.0	1.29	1.32	1.32	1.83	1.18	1.32	1.32	1.83
14.5	1.20	1.23	1.23	1.65	1.07	1.23	1.23	1.65
15.0	1.11	1.15	1.15	1.49	0.98	1.14	1.15	1.49
15.5	1.03	1.07	1.07	1.35	0.89	1.06	1.07	1.35
16.0	0.96	1.01	1.01	1.23	0.81	0.99	1.01	1.23
16.5	0.89	0.95	0.95	1.12	0.74	0.92	0.95	1.12
17.0	0.84	0.89	0.89	1.02	0.68	0.86	0.89	1.02
17.5	0.78	0.84	0.84	0.94	0.62	0.80	0.84	0.94
18.0	0.73	0.80	0.80	0.86	0.56	0.74	0.80	0.86

- 1B = One mid span brace
- 2B = Two equally spaced braces within the span
- 3B = Three equally spaced braces within the span
- w_s = Uniformly distributed serviceability load (kN/m) for deflection limit of Span/150
- $\phi_b w_u$ = Strength load resistance applied at the centroid (kN/m)

- 2-M12 Grade 4.6 bolts per connection
- 2-M12 Grade 8.8 bolts per connection
- 2-M16 Grade 4.6 bolts per connection
- 2-M16 Grade 8.8 bolts per connection

IMPORTANT

The adequacy of multispan system is very sensitive to actual applied loads. The stated loads in this table are assumed uniform over the full purlin system. Variations in actual project design loadings over the length of the purlin system must be checked specifically by the designer to verify system adequacy.

TWO SPAN CONTINUOUS

LOAD TABLE – Uniformly Distributed Load

MSS 350/23								
SPAN (m)	INWARDS				OUTWARDS			
	$\phi_b w_u$ kN/m			W_s kN/m	$\phi_b w_u$ kN/m			W_s kN/m
	1B	2B	3B		1B	2B	3B	
3.0								
3.5								
4.0								
4.5								
5.0								
5.5								
6.0	8.29	8.30	8.29	29.67	8.29	8.30	8.29	29.67
6.5	7.66	7.66	7.66	23.33	7.66	7.66	7.66	23.33
7.0	7.11	7.11	7.11	18.68	7.11	7.11	7.11	18.68
7.5	6.48	6.48	6.48	15.19	6.48	6.48	6.48	15.19
8.0	5.70	5.70	5.70	12.52	5.70	5.70	5.70	12.52
8.5	5.05	5.05	5.05	10.43	5.05	5.05	5.05	10.43
9.0	4.50	4.50	4.50	8.79	4.50	4.50	4.50	8.79
9.5	4.04	4.04	4.04	7.47	4.04	4.04	4.04	7.47
10.0	3.65	3.65	3.65	6.41	3.65	3.65	3.65	6.41
10.5	3.31	3.31	3.31	5.54	3.31	3.31	3.31	5.54
11.0	3.01	3.01	3.01	4.81	3.01	3.01	3.01	4.81
11.5	2.76	2.76	2.76	4.21	2.76	2.76	2.76	4.21
12.0	2.53	2.53	2.53	3.71	2.53	2.53	2.53	3.71
12.5	2.33	2.33	2.33	3.28	2.33	2.33	2.33	3.28
13.0	2.16	2.16	2.16	2.92	2.12	2.16	2.16	2.92
13.5	2.00	2.00	2.00	2.60	1.92	2.00	2.00	2.60
14.0	1.86	1.86	1.86	2.34	1.75	1.86	1.86	2.34
14.5	1.73	1.73	1.73	2.10	1.60	1.73	1.73	2.10
15.0	1.61	1.62	1.62	1.90	1.46	1.62	1.62	1.90
15.5	1.50	1.52	1.52	1.72	1.33	1.52	1.52	1.72
16.0	1.39	1.43	1.43	1.56	1.22	1.43	1.43	1.56
16.5	1.30	1.34	1.34	1.43	1.11	1.34	1.34	1.43
17.0	1.21	1.26	1.26	1.30	1.01	1.26	1.26	1.30
17.5	1.14	1.19	1.19	1.20	0.91	1.19	1.19	1.20
18.0	1.06	1.13	1.13	1.10	0.82	1.11	1.13	1.10

MSS 350/24								
SPAN (m)	INWARDS				OUTWARDS			
	$\phi_b w_u$ kN/m			W_s kN/m	$\phi_b w_u$ kN/m			W_s kN/m
	1B	2B	3B		1B	2B	3B	
3.0								
3.5								
4.0								
4.5								
5.0								
5.5								
6.0	8.85	8.85	8.85	31.55	8.85	8.85	8.85	31.55
6.5	8.17	8.17	8.17	24.81	8.17	8.17	8.17	24.81
7.0	7.58	7.58	7.58	19.87	7.58	7.58	7.58	19.87
7.5	7.08	7.08	7.08	16.15	7.08	7.08	7.08	16.15
8.0	6.22	6.22	6.22	13.31	6.22	6.22	6.22	13.31
8.5	5.51	5.51	5.51	11.10	5.51	5.51	5.51	11.10
9.0	4.92	4.92	4.92	9.35	4.92	4.92	4.92	9.35
9.5	4.41	4.41	4.41	7.95	4.41	4.41	4.41	7.95
10.0	3.98	3.98	3.98	6.81	3.98	3.98	3.98	6.81
10.5	3.61	3.61	3.61	5.89	3.61	3.61	3.61	5.89
11.0	3.29	3.29	3.29	5.12	3.29	3.29	3.29	5.12
11.5	3.01	3.01	3.01	4.48	3.01	3.01	3.01	4.48
12.0	2.77	2.77	2.77	3.94	2.77	2.77	2.77	3.94
12.5	2.55	2.55	2.55	3.49	2.55	2.55	2.55	3.49
13.0	2.36	2.36	2.36	3.10	2.35	2.36	2.36	3.10
13.5	2.19	2.19	2.19	2.77	2.14	2.19	2.19	2.77
14.0	2.03	2.03	2.03	2.48	1.95	2.03	2.03	2.48
14.5	1.89	1.89	1.89	2.24	1.78	1.89	1.89	2.24
15.0	1.77	1.77	1.77	2.02	1.61	1.77	1.77	2.02
15.5	1.65	1.66	1.66	1.83	1.46	1.66	1.66	1.83
16.0	1.54	1.56	1.56	1.66	1.32	1.56	1.56	1.66
16.5	1.43	1.46	1.46	1.52	1.20	1.46	1.46	1.52
17.0	1.34	1.38	1.38	1.39	1.09	1.38	1.38	1.39
17.5	1.25	1.30	1.30	1.27	0.98	1.30	1.30	1.27
18.0	1.17	1.23	1.23	1.17	0.89	1.23	1.23	1.17

- 1B = One mid span brace
- 2B = Two equally spaced braces within the span
- 3B = Three equally spaced braces within the span
- w_s = Uniformly distributed serviceability load (kN/m) for deflection limit of Span/150
- $\phi_b w_u$ = Strength load resistance applied at the centroid (kN/m)

- 2-M12 Grade 4.6 bolts per connection
- 2-M12 Grade 8.8 bolts per connection
- 2-M16 Grade 4.6 bolts per connection
- 2-M16 Grade 8.8 bolts per connection

IMPORTANT

The adequacy of multispan system is very sensitive to actual applied loads. The stated loads in this table are assumed uniform over the full purlin system. Variations in actual project design loadings over the length of the purlin system must be checked specifically by the designer to verify system adequacy.

TWO SPAN CONTINUOUS

LOAD TABLE – Uniformly Distributed Load

MSS 350/30								
SPAN (m)	INWARDS				OUTWARDS			
	$\phi_b w_u$ kN/m			Ws kN/m	$\phi_b w_u$ kN/m			Ws kN/m
	1B	2B	3B		1B	2B	3B	
3.0								
3.5								
4.0								
4.5								
5.0								
5.5								
6.0	10.9	10.9	10.9	38.41	10.9	10.9	10.9	38.41
6.5	10.0	10.0	10.0	30.21	10.0	10.0	10.0	30.21
7.0	9.32	9.32	9.32	24.19	9.32	9.32	9.32	24.19
7.5	8.70	8.70	8.70	19.66	8.70	8.70	8.70	19.66
8.0	8.16	8.16	8.16	16.20	8.16	8.16	8.16	16.20
8.5	7.28	7.28	7.28	13.51	7.28	7.28	7.28	13.51
9.0	6.49	6.49	6.49	11.38	6.49	6.49	6.49	11.38
9.5	5.83	5.83	5.83	9.68	5.83	5.83	5.83	9.68
10.0	5.26	5.26	5.26	8.30	5.26	5.26	5.26	8.30
10.5	4.77	4.77	4.77	7.17	4.77	4.77	4.77	7.17
11.0	4.35	4.35	4.35	6.23	4.35	4.35	4.35	6.23
11.5	3.98	3.98	3.98	5.45	3.98	3.98	3.98	5.45
12.0	3.65	3.65	3.65	4.80	3.65	3.65	3.65	4.80
12.5	3.37	3.37	3.37	4.25	3.37	3.37	3.37	4.25
13.0	3.11	3.11	3.11	3.78	3.03	3.11	3.11	3.78
13.5	2.88	2.89	2.89	3.37	2.74	2.89	2.89	3.37
14.0	2.64	2.68	2.68	3.02	2.47	2.68	2.68	3.02
14.5	2.43	2.50	2.50	2.72	2.23	2.50	2.50	2.72
15.0	2.24	2.34	2.34	2.46	2.01	2.34	2.34	2.46
15.5	2.07	2.19	2.19	2.23	1.82	2.19	2.19	2.23
16.0	1.92	2.05	2.05	2.03	1.65	2.05	2.05	2.03
16.5	1.78	1.93	1.93	1.85	1.49	1.93	1.93	1.85
17.0	1.65	1.82	1.82	1.69	1.34	1.82	1.82	1.69
17.5	1.53	1.72	1.72	1.55	1.21	1.72	1.72	1.55
18.0	1.43	1.62	1.62	1.42	1.09	1.62	1.62	1.42

MSS 400/20								
SPAN (m)	INWARDS				OUTWARDS			
	$\phi_b w_u$ kN/m			Ws kN/m	$\phi_b w_u$ kN/m			Ws kN/m
	1B	2B	3B		1B	2B	3B	
3.0								
3.5								
4.0								
4.5								
5.0								
5.5								
6.0	7.19	7.19	7.19	36.03	7.19	7.19	7.19	36.03
6.5	6.42	6.42	6.42	28.34	6.42	6.42	6.42	28.34
7.0	5.75	5.75	5.75	22.69	5.75	5.75	5.75	22.69
7.5	5.17	5.17	5.17	18.45	5.17	5.17	5.17	18.45
8.0	4.67	4.67	4.67	15.20	4.67	4.67	4.67	15.20
8.5	4.24	4.24	4.24	12.67	4.24	4.24	4.24	12.67
9.0	3.86	3.86	3.86	10.68	3.86	3.86	3.86	10.68
9.5	3.53	3.53	3.53	9.08	3.53	3.53	3.53	9.08
10.0	3.24	3.24	3.24	7.78	3.24	3.24	3.24	7.78
10.5	2.98	2.98	2.98	6.72	2.98	2.98	2.98	6.72
11.0	2.76	2.76	2.76	5.85	2.76	2.76	2.76	5.85
11.5	2.55	2.55	2.55	5.12	2.55	2.55	2.55	5.12
12.0	2.37	2.37	2.37	4.50	2.36	2.37	2.37	4.50
12.5	2.20	2.20	2.20	3.98	2.14	2.20	2.20	3.98
13.0	2.04	2.06	2.06	3.54	1.95	2.06	2.06	3.54
13.5	1.88	1.92	1.92	3.16	1.78	1.92	1.92	3.16
14.0	1.73	1.78	1.78	2.84	1.62	1.78	1.78	2.84
14.5	1.60	1.66	1.66	2.55	1.48	1.66	1.66	2.55
15.0	1.49	1.55	1.55	2.31	1.35	1.55	1.55	2.31
15.5	1.38	1.45	1.45	2.09	1.24	1.45	1.45	2.09
16.0	1.29	1.36	1.36	1.90	1.13	1.36	1.36	1.90
16.5	1.20	1.28	1.28	1.73	1.03	1.28	1.28	1.73
17.0	1.13	1.21	1.21	1.58	0.94	1.21	1.21	1.58
17.5	1.05	1.14	1.14	1.45	0.86	1.14	1.14	1.45
18.0	0.99	1.08	1.08	1.33	0.78	1.08	1.08	1.33

- 1B = One mid span brace
- 2B = Two equally spaced braces within the span
- 3B = Three equally spaced braces within the span
- w_s = Uniformly distributed serviceability load (kN/m) for deflection limit of Span/150
- $\phi_b w_u$ = Strength load resistance applied at the centroid (kN/m)

- 2-M12 Grade 4.6 bolts per connection
- 2-M12 Grade 8.8 bolts per connection
- 2-M16 Grade 4.6 bolts per connection
- 2-M16 Grade 8.8 bolts per connection

IMPORTANT

The adequacy of multispan system is very sensitive to actual applied loads. The stated loads in this table are assumed uniform over the full purlin system. Variations in actual project design loadings over the length of the purlin system must be checked specifically by the designer to verify system adequacy.

TWO SPAN CONTINUOUS

LOAD TABLE – Uniformly Distributed Load

MSS 400/23								
SPAN (m)	INWARDS				OUTWARDS			
	$\phi_b w_u$ kN/m			w_s kN/m	$\phi_b w_u$ kN/m			w_s kN/m
	1B	2B	3B		1B	2B	3B	
3.0								
3.5								
4.0								
4.5								
5.0								
5.5								
6.0	8.29	8.30	8.29	41.36	8.29	8.30	8.29	41.36
6.5	7.66	7.66	7.66	32.53	7.66	7.66	7.66	32.53
7.0	7.11	7.11	7.11	26.05	7.11	7.11	7.11	26.05
7.5	6.64	6.64	6.64	21.18	6.64	6.64	6.64	21.18
8.0	6.22	6.22	6.22	17.45	6.22	6.22	6.22	17.45
8.5	5.65	5.65	5.65	14.55	5.65	5.65	5.65	14.55
9.0	5.14	5.14	5.14	12.26	5.14	5.14	5.14	12.26
9.5	4.69	4.69	4.69	10.42	4.69	4.69	4.69	10.42
10.0	4.26	4.26	4.26	8.93	4.26	4.26	4.26	8.93
10.5	3.86	3.86	3.86	7.72	3.86	3.86	3.86	7.72
11.0	3.52	3.52	3.52	6.71	3.52	3.52	3.52	6.71
11.5	3.22	3.22	3.22	5.87	3.22	3.22	3.22	5.87
12.0	2.96	2.96	2.96	5.17	2.96	2.96	2.96	5.17
12.5	2.72	2.72	2.72	4.57	2.71	2.72	2.72	4.57
13.0	2.52	2.52	2.52	4.07	2.46	2.52	2.52	4.07
13.5	2.34	2.34	2.34	3.63	2.24	2.34	2.34	3.63
14.0	2.17	2.17	2.17	3.26	2.04	2.17	2.17	3.26
14.5	2.01	2.02	2.02	2.93	1.86	2.02	2.02	2.93
15.0	1.86	1.89	1.89	2.65	1.70	1.89	1.89	2.65
15.5	1.73	1.77	1.77	2.40	1.55	1.77	1.77	2.40
16.0	1.61	1.66	1.66	2.18	1.41	1.66	1.66	2.18
16.5	1.50	1.56	1.56	1.99	1.29	1.56	1.56	1.99
17.0	1.40	1.47	1.47	1.82	1.18	1.47	1.47	1.82
17.5	1.31	1.39	1.39	1.67	1.08	1.38	1.39	1.67
18.0	1.22	1.31	1.31	1.53	0.99	1.29	1.31	1.53

MSS 400/24								
SPAN (m)	INWARDS				OUTWARDS			
	$\phi_b w_u$ kN/m			w_s kN/m	$\phi_b w_u$ kN/m			w_s kN/m
	1B	2B	3B		1B	2B	3B	
3.0								
3.5								
4.0								
4.5								
5.0								
5.5								
6.0	8.85	8.85	8.85	44.00	8.85	8.85	8.85	44.00
6.5	8.17	8.17	8.17	34.60	8.17	8.17	8.17	34.60
7.0	7.58	7.58	7.58	27.71	7.58	7.58	7.58	27.71
7.5	7.08	7.08	7.08	22.53	7.08	7.08	7.08	22.53
8.0	6.64	6.64	6.64	18.56	6.64	6.64	6.64	18.56
8.5	6.25	6.25	6.25	15.47	6.25	6.25	6.25	15.47
9.0	5.74	5.74	5.74	13.04	5.74	5.74	5.74	13.04
9.5	5.15	5.15	5.15	11.08	5.15	5.15	5.15	11.08
10.0	4.65	4.65	4.65	9.50	4.65	4.65	4.65	9.50
10.5	4.22	4.22	4.22	8.21	4.22	4.22	4.22	8.21
11.0	3.84	3.84	3.84	7.14	3.84	3.84	3.84	7.14
11.5	3.52	3.52	3.52	6.25	3.52	3.52	3.52	6.25
12.0	3.23	3.23	3.23	5.50	3.23	3.23	3.23	5.50
12.5	2.98	2.98	2.98	4.87	2.98	2.98	2.98	4.87
13.0	2.75	2.75	2.75	4.33	2.73	2.75	2.75	4.33
13.5	2.55	2.55	2.55	3.86	2.48	2.55	2.55	3.86
14.0	2.37	2.37	2.37	3.46	2.26	2.37	2.37	3.46
14.5	2.21	2.21	2.21	3.12	2.06	2.21	2.21	3.12
15.0	2.05	2.07	2.07	2.82	1.88	2.07	2.07	2.82
15.5	1.90	1.94	1.94	2.55	1.72	1.94	1.94	2.55
16.0	1.77	1.82	1.82	2.32	1.57	1.82	1.82	2.32
16.5	1.65	1.71	1.71	2.12	1.44	1.71	1.71	2.12
17.0	1.54	1.61	1.61	1.93	1.31	1.61	1.61	1.93
17.5	1.44	1.52	1.52	1.77	1.20	1.52	1.52	1.77
18.0	1.34	1.44	1.44	1.63	1.08	1.43	1.44	1.63

- 1B = One mid span brace
- 2B = Two equally spaced braces within the span
- 3B = Three equally spaced braces within the span
- w_s = Uniformly distributed serviceability load (kN/m) for deflection limit of Span/150
- $\phi_b w_u$ = Strength load resistance applied at the centroid (kN/m)

- 2-M12 Grade 4.6 bolts per connection
- 2-M12 Grade 8.8 bolts per connection
- 2-M16 Grade 4.6 bolts per connection
- 2-M16 Grade 8.8 bolts per connection

IMPORTANT

The adequacy of multispan system is very sensitive to actual applied loads. The stated loads in this table are assumed uniform over the full purlin system. Variations in actual project design loadings over the length of the purlin system must be checked specifically by the designer to verify system adequacy.

TWO SPAN CONTINUOUS

LOAD TABLE – Uniformly Distributed Load

MSS 400/30								
SPAN (m)	INWARDS				OUTWARDS			
	$\phi_b w_u$ kN/m			W_s kN/m	$\phi_b w_u$ kN/m			W_s kN/m
	1B	2B	3B		1B	2B	3B	
3.0								
3.5								
4.0								
4.5								
5.0								
5.5								
6.0	10.9	10.9	10.9	53.62	10.9	10.9	10.9	53.62
6.5	10.0	10.0	10.0	42.17	10.0	10.0	10.0	42.17
7.0	9.32	9.32	9.32	33.76	9.32	9.32	9.32	33.76
7.5	8.70	8.70	8.70	27.45	8.70	8.70	8.70	27.45
8.0	8.16	8.16	8.16	22.62	8.16	8.16	8.16	22.62
8.5	7.68	7.68	7.68	18.86	7.68	7.68	7.68	18.86
9.0	7.25	7.25	7.25	15.89	7.25	7.25	7.25	15.89
9.5	6.82	6.82	6.82	13.51	6.82	6.82	6.82	13.51
10.0	6.16	6.16	6.16	11.58	6.16	6.16	6.16	11.58
10.5	5.59	5.59	5.59	10.00	5.59	5.59	5.59	10.00
11.0	5.09	5.09	5.09	8.70	5.09	5.09	5.09	8.70
11.5	4.66	4.66	4.66	7.61	4.66	4.66	4.66	7.61
12.0	4.28	4.28	4.28	6.70	4.28	4.28	4.28	6.70
12.5	3.94	3.94	3.94	5.93	3.94	3.94	3.94	5.93
13.0	3.64	3.64	3.64	5.27	3.64	3.64	3.64	5.27
13.5	3.38	3.38	3.38	4.71	3.34	3.38	3.38	4.71
14.0	3.14	3.14	3.14	4.22	3.02	3.14	3.14	4.22
14.5	2.93	2.93	2.93	3.80	2.73	2.93	2.93	3.80
15.0	2.70	2.74	2.74	3.43	2.46	2.74	2.74	3.43
15.5	2.49	2.56	2.56	3.11	2.22	2.56	2.56	3.11
16.0	2.30	2.41	2.41	2.83	2.01	2.41	2.41	2.83
16.5	2.13	2.26	2.26	2.58	1.81	2.26	2.26	2.58
17.0	1.98	2.13	2.13	2.36	1.64	2.13	2.13	2.36
17.5	1.84	2.01	2.01	2.16	1.48	2.01	2.01	2.16
18.0	1.71	1.90	1.90	1.99	1.33	1.90	1.90	1.99

- 1B = One mid span brace
- 2B = Two equally spaced braces within the span
- 3B = Three equally spaced braces within the span
- w_s = Uniformly distributed serviceability load (kN/m) for deflection limit of Span/150
- $\phi_b w_u$ = Strength load resistance applied at the centroid (kN/m)

- 2-M12 Grade 4.6 bolts per connection
- 2-M12 Grade 8.8 bolts per connection
- 2-M16 Grade 4.6 bolts per connection
- 2-M16 Grade 8.8 bolts per connection

IMPORTANT

The adequacy of multispan system is very sensitive to actual applied loads. The stated loads in this table are assumed uniform over the full purlin system. Variations in actual project design loadings over the length of the purlin system must be checked specifically by the designer to verify system adequacy.

THREE SPAN CONTINUOUS

LOAD TABLE – Uniformly Distributed Load

MSS 150/12								
SPAN (m)	INWARDS				OUTWARDS			
	$\phi_b w_u$ kN/m			w_s kN/m	$\phi_b w_u$ kN/m			w_s kN/m
	1B	2B	3B		1B	2B	3B	
3.0	6.85	6.85	6.85	9.83	6.85	6.85	6.85	9.83
3.5	5.03	5.03	5.03	6.19	6.85	6.85	6.85	6.19
4.0	3.85	3.85	3.85	4.15	6.85	6.85	6.85	4.15
4.5	3.04	3.04	3.04	2.91	6.85	6.85	6.85	2.91
5.0	2.47	2.47	2.47	2.12	6.85	6.85	6.85	2.12
5.5	2.04	2.04	2.04	1.60	6.85	6.85	6.85	1.60
6.0	1.71	1.71	1.71	1.23	6.85	6.85	6.85	1.23
6.5	1.46	1.46	1.46	0.97	6.85	6.85	6.85	0.97
7.0	1.26	1.26	1.26	0.77	6.85	6.85	6.85	0.77
7.5	1.10	1.10	1.10	0.63	6.85	6.85	6.85	0.63
8.0	0.96	0.96	0.96	0.52	6.85	6.85	6.85	0.52
8.5	0.85	0.85	0.85	0.43	6.85	6.85	6.85	0.43
9.0	0.76	0.76	0.76	0.36	6.85	6.85	6.85	0.36
9.5	0.68	0.68	0.68	0.31	6.85	6.85	6.85	0.31
10.0	0.62	0.62	0.62	0.27	6.85	6.85	6.85	0.27
10.5	0.56	0.56	0.56	0.23	6.85	6.85	6.85	0.23
11.0	0.51	0.51	0.51	0.20	6.85	6.85	6.85	0.20
11.5								
12.0								
12.5								
13.0								
13.5								
14.0								
14.5								
15.0								
15.5								
16.0								
16.5								
17.0								
17.5								
18.0								

MSS 150/15								
SPAN (m)	INWARDS				OUTWARDS			
	$\phi_b w_u$ kN/m			w_s kN/m	$\phi_b w_u$ kN/m			w_s kN/m
	1B	2B	3B		1B	2B	3B	
3.0	9.37	9.37	9.37	12.27	9.37	9.37	9.37	12.27
3.5	6.88	6.88	6.88	7.73	6.88	6.88	6.88	7.73
4.0	5.27	5.27	5.27	5.18	5.27	5.27	5.27	5.18
4.5	4.16	4.16	4.16	3.64	4.16	4.16	4.16	3.64
5.0	3.37	3.37	3.37	2.65	3.37	3.37	3.37	2.65
5.5	2.79	2.79	2.79	1.99	2.79	2.79	2.79	1.99
6.0	2.34	2.34	2.34	1.53	2.34	2.34	2.34	1.53
6.5	2.00	2.00	2.00	1.21	1.94	2.00	2.00	1.21
7.0	1.72	1.72	1.72	0.97	1.61	1.72	1.72	0.97
7.5	1.50	1.50	1.50	0.79	1.33	1.50	1.50	0.79
8.0	1.32	1.32	1.32	0.65	1.11	1.32	1.32	0.65
8.5	1.17	1.17	1.17	0.54	0.92	1.17	1.17	0.54
9.0	1.04	1.04	1.04	0.45	0.77	1.02	1.04	0.45
9.5	0.93	0.93	0.93	0.39	0.64	0.88	0.93	0.39
10.0	0.84	0.84	0.84	0.33	0.53	0.77	0.84	0.33
10.5	0.76	0.76	0.76	0.29	0.44	0.68	0.76	0.29
11.0	0.70	0.70	0.70	0.25	0.37	0.59	0.69	0.25
11.5								
12.0								
12.5								
13.0								
13.5								
14.0								
14.5								
15.0								
15.5								
16.0								
16.5								
17.0								
17.5								
18.0								

- 1B = One mid span brace
- 2B = Two equally spaced braces within the span
- 3B = Three equally spaced braces within the span
- w_s = Uniformly distributed serviceability load (kN/m) for deflection limit of Span/150
- $\phi_b w_u$ = Strength load resistance applied at the centroid (kN/m)

- 2-M12 Grade 4.6 bolts per connection
- 2-M12 Grade 8.8 bolts per connection
- 2-M16 Grade 4.6 bolts per connection
- 2-M16 Grade 8.8 bolts per connection

IMPORTANT

The adequacy of multispan system is very sensitive to actual applied loads. The stated loads in this table are assumed uniform over the full purlin system. Variations in actual project design loadings over the length of the purlin system must be checked specifically by the designer to verify system adequacy.

THREE SPAN CONTINUOUS

LOAD TABLE – Uniformly Distributed Load

MSS 150/18								
SPAN (m)	INWARDS				OUTWARDS			
	$\phi_b w_u$ kN/m			W_s kN/m	$\phi_b w_u$ kN/m			W_s kN/m
	1B	2B	3B		1B	2B	3B	
3.0	11.2	11.2	11.2	14.64	11.2	11.2	11.2	14.64
3.5	8.22	8.22	8.22	9.22	8.22	8.22	8.22	9.22
4.0	6.29	6.29	6.29	6.18	6.29	6.29	6.29	6.18
4.5	4.97	4.97	4.97	4.34	4.97	4.97	4.97	4.34
5.0	4.03	4.03	4.03	3.16	4.03	4.03	4.03	3.16
5.5	3.33	3.33	3.33	2.38	3.33	3.33	3.33	2.38
6.0	2.80	2.80	2.80	1.83	2.79	2.80	2.80	1.83
6.5	2.38	2.38	2.38	1.44	2.29	2.38	2.38	1.44
7.0	2.06	2.06	2.06	1.15	1.90	2.06	2.06	1.15
7.5	1.79	1.79	1.79	0.94	1.59	1.79	1.79	0.94
8.0	1.57	1.57	1.57	0.77	1.33	1.57	1.57	0.77
8.5	1.39	1.39	1.39	0.64	1.11	1.38	1.39	0.64
9.0	1.24	1.24	1.24	0.54	0.92	1.20	1.24	0.54
9.5	1.12	1.12	1.12	0.46	0.77	1.05	1.12	0.46
10.0	1.00	1.01	1.01	0.40	0.64	0.92	1.01	0.40
10.5	0.90	0.91	0.91	0.34	0.53	0.81	0.91	0.34
11.0	0.81	0.83	0.83	0.30	0.45	0.71	0.81	0.30
11.5								
12.0								
12.5								
13.0								
13.5								
14.0								
14.5								
15.0								
15.5								
16.0								
16.5								
17.0								
17.5								
18.0								

MSS 150/23								
SPAN (m)	INWARDS				OUTWARDS			
	$\phi_b w_u$ kN/m			W_s kN/m	$\phi_b w_u$ kN/m			W_s kN/m
	1B	2B	3B		1B	2B	3B	
3.0	15.4	15.4	15.4	18.52	15.4	15.4	15.4	18.52
3.5	11.3	11.3	11.3	11.66	11.3	11.3	11.3	11.66
4.0	8.67	8.67	8.67	7.81	8.67	8.67	8.67	7.81
4.5	6.85	6.85	6.85	5.49	6.85	6.85	6.85	5.49
5.0	5.55	5.55	5.55	4.00	5.52	5.55	5.55	4.00
5.5	4.58	4.58	4.58	3.01	4.42	4.58	4.58	3.01
6.0	3.82	3.85	3.85	2.31	3.59	3.85	3.85	2.31
6.5	3.22	3.28	3.28	1.82	2.94	3.28	3.28	1.82
7.0	2.74	2.83	2.83	1.46	2.43	2.81	2.83	1.46
7.5	2.36	2.47	2.47	1.19	2.02	2.40	2.47	1.19
8.0	2.06	2.17	2.17	0.98	1.69	2.06	2.17	0.98
8.5	1.80	1.92	1.92	0.81	1.42	1.77	1.92	0.81
9.0	1.59	1.71	1.71	0.69	1.19	1.54	1.69	0.69
9.5	1.41	1.54	1.54	0.58	1.00	1.34	1.49	0.58
10.0	1.26	1.39	1.39	0.50	0.83	1.17	1.32	0.50
10.5	1.13	1.25	1.26	0.43	0.70	1.03	1.17	0.43
11.0	1.02	1.13	1.15	0.38	0.59	0.90	1.04	0.38
11.5								
12.0								
12.5								
13.0								
13.5								
14.0								
14.5								
15.0								
15.5								
16.0								
16.5								
17.0								
17.5								
18.0								

- 1B = One mid span brace
- 2B = Two equally spaced braces within the span
- 3B = Three equally spaced braces within the span
- w_s = Uniformly distributed serviceability load (kN/m) for deflection limit of Span/150
- $\phi_b w_u$ = Strength load resistance applied at the centroid (kN/m)

- 2-M12 Grade 4.6 bolts per connection
- 2-M12 Grade 8.8 bolts per connection
- 2-M16 Grade 4.6 bolts per connection
- 2-M16 Grade 8.8 bolts per connection

IMPORTANT

The adequacy of multispan system is very sensitive to actual applied loads. The stated loads in this table are assumed uniform over the full purlin system. Variations in actual project design loadings over the length of the purlin system must be checked specifically by the designer to verify system adequacy.

THREE SPAN CONTINUOUS

LOAD TABLE – Uniformly Distributed Load

MSS 200/12								
SPAN (m)	INWARDS				OUTWARDS			
	$\phi_b w_u$ kN/m			W_s kN/m	$\phi_b w_u$ kN/m			W_s kN/m
	1B	2B	3B		1B	2B	3B	
3.0	8.26	8.26	8.26	21.17	8.26	8.26	8.26	21.17
3.5	6.45	6.45	6.45	13.33	6.45	6.45	6.45	13.33
4.0	5.16	5.16	5.16	8.93	5.16	5.16	5.16	8.93
4.5	4.22	4.22	4.22	6.27	4.22	4.22	4.22	6.27
5.0	3.50	3.50	3.50	4.57	3.50	3.50	3.50	4.57
5.5	2.89	2.89	2.89	3.44	2.89	2.89	2.89	3.44
6.0	2.43	2.43	2.43	2.65	2.43	2.43	2.43	2.65
6.5	2.07	2.07	2.07	2.08	2.05	2.07	2.07	2.08
7.0	1.79	1.79	1.79	1.67	1.72	1.79	1.79	1.67
7.5	1.56	1.56	1.56	1.36	1.46	1.56	1.56	1.36
8.0	1.37	1.37	1.37	1.12	1.24	1.37	1.37	1.12
8.5	1.21	1.21	1.21	0.93	1.06	1.21	1.21	0.93
9.0	1.08	1.08	1.08	0.78	0.90	1.07	1.08	0.78
9.5	0.97	0.97	0.97	0.67	0.77	0.94	0.97	0.67
10.0	0.87	0.87	0.87	0.57	0.66	0.83	0.87	0.57
10.5	0.79	0.79	0.79	0.49	0.57	0.74	0.79	0.49
11.0	0.72	0.72	0.72	0.43	0.49	0.66	0.72	0.43
11.5	0.65	0.66	0.66	0.38	0.42	0.59	0.65	0.38
12.0	0.59	0.61	0.61	0.33	0.36	0.52	0.59	0.33
12.5	0.54	0.56	0.56	0.29	0.31	0.47	0.53	0.29
13.0	0.50	0.52	0.52	0.26	0.27	0.42	0.48	0.26
13.5	0.46	0.48	0.48	0.23	0.24	0.37	0.44	0.23
14.0	0.42	0.45	0.45	0.21	0.21	0.33	0.40	0.21
14.5	0.39	0.42	0.42	0.19	0.18	0.30	0.37	0.19
15.0	0.36	0.38	0.39	0.17	0.16	0.27	0.34	0.17
15.5								
16.0								
16.5								
17.0								
17.5								
18.0								

MSS 200/15								
SPAN (m)	INWARDS				OUTWARDS			
	$\phi_b w_u$ kN/m			W_s kN/m	$\phi_b w_u$ kN/m			W_s kN/m
	1B	2B	3B		1B	2B	3B	
3.0	12.7	12.7	12.7	26.41	12.7	12.7	12.7	26.41
3.5	9.85	9.85	9.85	16.63	9.85	9.85	9.85	16.63
4.0	7.54	7.54	7.54	11.14	7.54	7.54	7.54	11.14
4.5	5.96	5.96	5.96	7.83	5.96	5.96	5.96	7.83
5.0	4.82	4.82	4.82	5.71	4.82	4.82	4.82	5.71
5.5	3.99	3.99	3.99	4.29	3.99	3.99	3.99	4.29
6.0	3.35	3.35	3.35	3.30	3.35	3.35	3.35	3.30
6.5	2.85	2.85	2.85	2.60	2.85	2.85	2.85	2.60
7.0	2.46	2.46	2.46	2.08	2.46	2.46	2.46	2.08
7.5	2.14	2.14	2.14	1.69	2.14	2.14	2.14	1.69
8.0	1.88	1.88	1.88	1.39	1.82	1.88	1.88	1.39
8.5	1.67	1.67	1.67	1.16	1.56	1.67	1.67	1.16
9.0	1.49	1.49	1.49	0.98	1.32	1.49	1.49	0.98
9.5	1.34	1.34	1.34	0.83	1.12	1.34	1.34	0.83
10.0	1.21	1.21	1.21	0.71	0.94	1.21	1.21	0.71
10.5	1.09	1.09	1.09	0.62	0.79	1.09	1.09	0.62
11.0	1.00	1.00	1.00	0.54	0.67	0.97	1.00	0.54
11.5	0.91	0.91	0.91	0.47	0.57	0.86	0.91	0.47
12.0	0.84	0.84	0.84	0.41	0.49	0.77	0.84	0.41
12.5	0.77	0.77	0.77	0.37	0.42	0.68	0.77	0.37
13.0	0.71	0.71	0.71	0.32	0.36	0.61	0.71	0.32
13.5	0.66	0.66	0.66	0.29	0.31	0.54	0.65	0.29
14.0	0.61	0.62	0.62	0.26	0.27	0.47	0.59	0.26
14.5	0.56	0.57	0.57	0.23	0.24	0.42	0.54	0.23
15.0	0.52	0.54	0.54	0.21	0.21	0.37	0.49	0.21
15.5								
16.0								
16.5								
17.0								
17.5								
18.0								

- 1B = One mid span brace
- 2B = Two equally spaced braces within the span
- 3B = Three equally spaced braces within the span
- w_s = Uniformly distributed serviceability load (kN/m) for deflection limit of Span/150
- $\phi_b w_u$ = Strength load resistance applied at the centroid (kN/m)

- 2-M12 Grade 4.6 bolts per connection
- 2-M12 Grade 8.8 bolts per connection
- 2-M16 Grade 4.6 bolts per connection
- 2-M16 Grade 8.8 bolts per connection

IMPORTANT

The adequacy of multispan system is very sensitive to actual applied loads. The stated loads in this table are assumed uniform over the full purlin system. Variations in actual project design loadings over the length of the purlin system must be checked specifically by the designer to verify system adequacy.

THREE SPAN CONTINUOUS

LOAD TABLE – Uniformly Distributed Load

MSS 200/18								
SPAN (m)	INWARDS				OUTWARDS			
	$\phi_b w_u$ kN/m			w_s kN/m	$\phi_b w_u$ kN/m			w_s kN/m
	1B	2B	3B		1B	2B	3B	
3.0	14.7	14.7	14.7	31.65	14.7	14.7	14.7	31.65
3.5	11.9	11.9	11.9	19.93	11.9	11.9	11.9	19.93
4.0	9.10	9.10	9.10	13.35	9.10	9.10	9.10	13.35
4.5	7.19	7.19	7.19	9.38	7.19	7.19	7.19	9.38
5.0	5.82	5.82	5.82	6.84	5.82	5.82	5.82	6.84
5.5	4.81	4.81	4.81	5.14	4.81	4.81	4.81	5.14
6.0	4.04	4.04	4.04	3.96	4.04	4.04	4.04	3.96
6.5	3.45	3.45	3.45	3.11	3.45	3.45	3.45	3.11
7.0	2.97	2.97	2.97	2.49	2.97	2.97	2.97	2.49
7.5	2.59	2.59	2.59	2.03	2.59	2.59	2.59	2.03
8.0	2.28	2.28	2.28	1.67	2.21	2.28	2.28	1.67
8.5	2.02	2.02	2.02	1.39	1.88	2.02	2.02	1.39
9.0	1.80	1.80	1.80	1.17	1.60	1.80	1.80	1.17
9.5	1.61	1.61	1.61	1.00	1.37	1.61	1.61	1.00
10.0	1.46	1.46	1.46	0.85	1.16	1.46	1.46	0.85
10.5	1.32	1.32	1.32	0.74	0.99	1.32	1.32	0.74
11.0	1.20	1.20	1.20	0.64	0.84	1.18	1.20	0.64
11.5	1.10	1.10	1.10	0.56	0.71	1.05	1.10	0.56
12.0	1.01	1.01	1.01	0.49	0.60	0.93	1.01	0.49
12.5	0.93	0.93	0.93	0.44	0.51	0.83	0.93	0.44
13.0	0.86	0.86	0.86	0.39	0.44	0.74	0.86	0.39
13.5	0.79	0.80	0.80	0.35	0.38	0.66	0.79	0.35
14.0	0.73	0.74	0.74	0.31	0.33	0.59	0.72	0.31
14.5	0.67	0.69	0.69	0.28	0.29	0.52	0.65	0.28
15.0	0.62	0.65	0.65	0.25	0.25	0.46	0.60	0.25
15.5								
16.0								
16.5								
17.0								
17.5								
18.0								

MSS 200/23								
SPAN (m)	INWARDS				OUTWARDS			
	$\phi_b w_u$ kN/m			w_s kN/m	$\phi_b w_u$ kN/m			w_s kN/m
	1B	2B	3B		1B	2B	3B	
3.0	18.9	18.9	18.9	40.05	18.9	18.9	18.9	40.05
3.5	16.2	16.2	16.2	25.22	16.2	16.2	16.2	25.22
4.0	12.7	12.7	12.7	16.90	12.7	12.7	12.7	16.90
4.5	10.0	10.0	10.0	11.87	10.0	10.0	10.0	11.87
5.0	8.13	8.13	8.13	8.65	8.13	8.13	8.13	8.65
5.5	6.72	6.72	6.72	6.50	6.72	6.72	6.72	6.50
6.0	5.65	5.65	5.65	5.01	5.65	5.65	5.65	5.01
6.5	4.81	4.81	4.81	3.94	4.78	4.81	4.81	3.94
7.0	4.15	4.15	4.15	3.15	4.04	4.15	4.15	3.15
7.5	3.62	3.62	3.62	2.56	3.43	3.62	3.62	2.56
8.0	3.16	3.18	3.18	2.11	2.93	3.18	3.18	2.11
8.5	2.78	2.81	2.81	1.76	2.48	2.81	2.81	1.76
9.0	2.46	2.51	2.51	1.48	2.10	2.49	2.51	1.48
9.5	2.20	2.25	2.25	1.26	1.78	2.21	2.25	1.26
10.0	1.97	2.03	2.03	1.08	1.51	1.96	2.03	1.08
10.5	1.77	1.84	1.84	0.93	1.28	1.74	1.84	0.93
11.0	1.60	1.68	1.68	0.81	1.08	1.56	1.68	0.81
11.5	1.45	1.54	1.54	0.71	0.91	1.38	1.52	0.71
12.0	1.33	1.41	1.41	0.63	0.77	1.23	1.38	0.63
12.5	1.21	1.30	1.30	0.55	0.66	1.09	1.25	0.55
13.0	1.11	1.20	1.20	0.49	0.57	0.96	1.14	0.49
13.5	1.02	1.11	1.12	0.44	0.50	0.86	1.04	0.44
14.0	0.94	1.03	1.04	0.39	0.43	0.76	0.95	0.39
14.5	0.86	0.96	0.97	0.35	0.38	0.67	0.86	0.35
15.0	0.79	0.89	0.90	0.32	0.34	0.59	0.78	0.32
15.5								
16.0								
16.5								
17.0								
17.5								
18.0								

- 1B = One mid span brace
- 2B = Two equally spaced braces within the span
- 3B = Three equally spaced braces within the span
- w_s = Uniformly distributed serviceability load (kN/m) for deflection limit of Span/150
- $\phi_b w_u$ = Strength load resistance applied at the centroid (kN/m)

- 2-M12 Grade 4.6 bolts per connection
- 2-M12 Grade 8.8 bolts per connection
- 2-M16 Grade 4.6 bolts per connection
- 2-M16 Grade 8.8 bolts per connection

IMPORTANT

The adequacy of multispan system is very sensitive to actual applied loads. The stated loads in this table are assumed uniform over the full purlin system. Variations in actual project design loadings over the length of the purlin system must be checked specifically by the designer to verify system adequacy.

THREE SPAN CONTINUOUS

LOAD TABLE – Uniformly Distributed Load

MSS 250/13								
SPAN (m)	INWARDS				OUTWARDS			
	$\phi_b w_u$ kN/m			w_s kN/m	$\phi_b w_u$ kN/m			w_s kN/m
	1B	2B	3B		1B	2B	3B	
3.0								
3.5								
4.0	7.15	7.15	7.15	17.96	7.15	7.15	7.15	17.96
4.5	5.91	5.91	5.91	12.61	5.91	5.91	5.91	12.61
5.0	4.95	4.95	4.95	9.19	4.95	4.95	4.95	9.19
5.5	4.20	4.20	4.20	6.91	4.20	4.20	4.20	6.91
6.0	3.61	3.61	3.61	5.32	3.61	3.61	3.61	5.32
6.5	3.12	3.12	3.12	4.18	3.12	3.12	3.12	4.18
7.0	2.73	2.73	2.73	3.35	2.69	2.73	2.73	3.35
7.5	2.41	2.41	2.41	2.72	2.30	2.41	2.41	2.72
8.0	2.12	2.14	2.14	2.24	1.97	2.14	2.14	2.24
8.5	1.86	1.90	1.90	1.87	1.70	1.89	1.90	1.87
9.0	1.65	1.69	1.69	1.58	1.48	1.66	1.69	1.58
9.5	1.47	1.52	1.52	1.34	1.29	1.47	1.52	1.34
10.0	1.32	1.37	1.37	1.15	1.12	1.31	1.37	1.15
10.5	1.19	1.24	1.24	0.99	0.98	1.17	1.24	0.99
11.0	1.08	1.13	1.13	0.86	0.86	1.05	1.12	0.86
11.5	0.98	1.04	1.04	0.76	0.75	0.94	1.01	0.76
12.0	0.89	0.95	0.95	0.67	0.65	0.85	0.92	0.67
12.5	0.82	0.88	0.88	0.59	0.57	0.77	0.84	0.59
13.0	0.75	0.81	0.81	0.52	0.50	0.69	0.77	0.52
13.5	0.69	0.74	0.75	0.47	0.44	0.63	0.70	0.47
14.0	0.64	0.69	0.70	0.42	0.40	0.57	0.64	0.42
14.5	0.59	0.64	0.65	0.38	0.35	0.52	0.59	0.38
15.0	0.55	0.59	0.61	0.34	0.32	0.47	0.54	0.34
15.5	0.51	0.55	0.57	0.31	0.28	0.42	0.50	0.31
16.0	0.47	0.51	0.54	0.28	0.25	0.38	0.46	0.28
16.5	0.44	0.48	0.50	0.26	0.23	0.35	0.43	0.26
17.0	0.41	0.45	0.47	0.23	0.20	0.32	0.39	0.23
17.5								
18.0								

MSS 250/15								
SPAN (m)	INWARDS				OUTWARDS			
	$\phi_b w_u$ kN/m			w_s kN/m	$\phi_b w_u$ kN/m			w_s kN/m
	1B	2B	3B		1B	2B	3B	
3.0								
3.5								
4.0	9.43	9.43	9.43	20.71	9.43	9.43	9.43	20.71
4.5	7.74	7.74	7.74	14.55	7.74	7.74	7.74	14.55
5.0	6.45	6.45	6.45	10.60	6.45	6.45	6.45	10.60
5.5	5.45	5.45	5.45	7.97	5.45	5.45	5.45	7.97
6.0	4.66	4.66	4.66	6.14	4.66	4.66	4.66	6.14
6.5	3.99	3.99	3.99	4.83	3.99	3.99	3.99	4.83
7.0	3.44	3.44	3.44	3.86	3.40	3.44	3.44	3.86
7.5	2.99	2.99	2.99	3.14	2.90	2.99	2.99	3.14
8.0	2.63	2.63	2.63	2.59	2.49	2.63	2.63	2.59
8.5	2.33	2.33	2.33	2.16	2.15	2.33	2.33	2.16
9.0	2.06	2.08	2.08	1.82	1.87	2.08	2.08	1.82
9.5	1.84	1.87	1.87	1.55	1.62	1.86	1.87	1.55
10.0	1.65	1.68	1.68	1.33	1.42	1.65	1.68	1.33
10.5	1.48	1.53	1.53	1.15	1.24	1.48	1.53	1.15
11.0	1.34	1.39	1.39	1.00	1.09	1.32	1.39	1.00
11.5	1.22	1.27	1.27	0.87	0.95	1.19	1.27	0.87
12.0	1.11	1.17	1.17	0.77	0.83	1.07	1.16	0.77
12.5	1.02	1.08	1.08	0.68	0.73	0.97	1.06	0.68
13.0	0.93	1.00	1.00	0.60	0.64	0.88	0.97	0.60
13.5	0.86	0.92	0.92	0.54	0.56	0.79	0.89	0.54
14.0	0.79	0.86	0.86	0.48	0.49	0.72	0.81	0.48
14.5	0.73	0.80	0.80	0.43	0.44	0.65	0.75	0.43
15.0	0.68	0.74	0.75	0.39	0.38	0.59	0.69	0.39
15.5	0.63	0.69	0.70	0.36	0.34	0.54	0.63	0.36
16.0	0.59	0.64	0.66	0.32	0.30	0.49	0.58	0.32
16.5	0.55	0.60	0.62	0.30	0.27	0.44	0.54	0.30
17.0	0.51	0.56	0.58	0.27	0.24	0.40	0.50	0.27
17.5								
18.0								

- 1B = One mid span brace
- 2B = Two equally spaced braces within the span
- 3B = Three equally spaced braces within the span
- w_s = Uniformly distributed serviceability load (kN/m) for deflection limit of Span/150
- $\phi_b w_u$ = Strength load resistance applied at the centroid (kN/m)

- 2-M12 Grade 4.6 bolts per connection
- 2-M12 Grade 8.8 bolts per connection
- 2-M16 Grade 4.6 bolts per connection
- 2-M16 Grade 8.8 bolts per connection

IMPORTANT

The adequacy of multispan system is very sensitive to actual applied loads. The stated loads in this table are assumed uniform over the full purlin system. Variations in actual project design loadings over the length of the purlin system must be checked specifically by the designer to verify system adequacy.

THREE SPAN CONTINUOUS

LOAD TABLE – Uniformly Distributed Load

MSS 250/18								
SPAN (m)	INWARDS				OUTWARDS			
	$\phi_b w_u$ kN/m			w_s kN/m	$\phi_b w_u$ kN/m			w_s kN/m
	1B	2B	3B		1B	2B	3B	
3.0								
3.5								
4.0	11.0	11.0	11.0	24.83	11.0	11.0	11.0	24.83
4.5	9.78	9.78	9.77	17.44	9.78	9.78	9.77	17.44
5.0	8.18	8.18	8.18	12.71	8.18	8.18	8.18	12.71
5.5	6.76	6.76	6.76	9.55	6.76	6.76	6.76	9.55
6.0	5.68	5.68	5.68	7.36	5.68	5.68	5.68	7.36
6.5	4.84	4.84	4.84	5.79	4.84	4.84	4.84	5.79
7.0	4.17	4.17	4.17	4.63	4.17	4.17	4.17	4.63
7.5	3.63	3.63	3.63	3.77	3.63	3.63	3.63	3.77
8.0	3.19	3.19	3.19	3.10	3.19	3.19	3.19	3.10
8.5	2.83	2.83	2.83	2.59	2.80	2.83	2.83	2.59
9.0	2.52	2.52	2.52	2.18	2.44	2.52	2.52	2.18
9.5	2.27	2.27	2.27	1.85	2.14	2.27	2.27	1.85
10.0	2.04	2.04	2.04	1.59	1.88	2.04	2.04	1.59
10.5	1.85	1.85	1.85	1.37	1.64	1.85	1.85	1.37
11.0	1.69	1.69	1.69	1.19	1.43	1.69	1.69	1.19
11.5	1.55	1.55	1.55	1.04	1.25	1.55	1.55	1.04
12.0	1.42	1.42	1.42	0.92	1.09	1.40	1.42	0.92
12.5	1.30	1.31	1.31	0.81	0.94	1.27	1.31	0.81
13.0	1.19	1.21	1.21	0.72	0.82	1.15	1.21	0.72
13.5	1.10	1.12	1.12	0.65	0.71	1.05	1.12	0.65
14.0	1.02	1.04	1.04	0.58	0.62	0.95	1.04	0.58
14.5	0.94	0.97	0.97	0.52	0.55	0.87	0.97	0.52
15.0	0.87	0.91	0.91	0.47	0.48	0.78	0.89	0.47
15.5	0.81	0.85	0.85	0.43	0.42	0.71	0.83	0.43
16.0	0.75	0.80	0.80	0.39	0.38	0.64	0.77	0.39
16.5	0.70	0.75	0.75	0.35	0.33	0.58	0.71	0.35
17.0	0.66	0.71	0.71	0.32	0.30	0.52	0.66	0.32
17.5								
18.0								

MSS 250/23								
SPAN (m)	INWARDS				OUTWARDS			
	$\phi_b w_u$ kN/m			w_s kN/m	$\phi_b w_u$ kN/m			w_s kN/m
	1B	2B	3B		1B	2B	3B	
3.0								
3.5								
4.0	14.1	14.1	14.1	31.55	14.1	14.1	14.1	31.55
4.5	12.6	12.6	12.6	22.16	12.6	12.6	12.6	22.16
5.0	11.3	11.3	11.3	16.16	11.3	11.3	11.3	16.16
5.5	9.47	9.47	9.47	12.14	9.47	9.47	9.47	12.14
6.0	7.96	7.96	7.96	9.35	7.96	7.96	7.96	9.35
6.5	6.78	6.78	6.78	7.35	6.78	6.78	6.78	7.35
7.0	5.85	5.85	5.85	5.89	5.85	5.85	5.85	5.89
7.5	5.09	5.09	5.09	4.79	5.09	5.09	5.09	4.79
8.0	4.48	4.48	4.48	3.94	4.48	4.48	4.48	3.94
8.5	3.97	3.97	3.97	3.29	3.97	3.97	3.97	3.29
9.0	3.54	3.54	3.54	2.77	3.44	3.54	3.54	2.77
9.5	3.18	3.18	3.18	2.36	2.98	3.18	3.18	2.36
10.0	2.87	2.87	2.87	2.02	2.58	2.87	2.87	2.02
10.5	2.60	2.60	2.60	1.74	2.25	2.60	2.60	1.74
11.0	2.37	2.37	2.37	1.52	1.95	2.37	2.37	1.52
11.5	2.15	2.17	2.17	1.33	1.69	2.17	2.17	1.33
12.0	1.96	1.99	1.99	1.17	1.46	1.98	1.99	1.17
12.5	1.79	1.83	1.83	1.03	1.25	1.78	1.83	1.03
13.0	1.63	1.70	1.70	0.92	1.08	1.61	1.70	0.92
13.5	1.50	1.57	1.57	0.82	0.93	1.45	1.57	0.82
14.0	1.38	1.46	1.46	0.74	0.81	1.31	1.46	0.74
14.5	1.27	1.36	1.36	0.66	0.71	1.19	1.36	0.66
15.0	1.18	1.27	1.27	0.60	0.62	1.07	1.27	0.60
15.5	1.09	1.19	1.19	0.54	0.55	0.96	1.17	0.54
16.0	1.01	1.12	1.12	0.49	0.49	0.87	1.07	0.49
16.5	0.94	1.05	1.05	0.45	0.43	0.78	0.99	0.45
17.0	0.88	0.99	0.99	0.41	0.39	0.70	0.91	0.41
17.5								
18.0								

- 1B = One mid span brace
- 2B = Two equally spaced braces within the span
- 3B = Three equally spaced braces within the span
- w_s = Uniformly distributed serviceability load (kN/m) for deflection limit of Span/150
- $\phi_b w_u$ = Strength load resistance applied at the centroid (kN/m)

- 2-M12 Grade 4.6 bolts per connection
- 2-M12 Grade 8.8 bolts per connection
- 2-M16 Grade 4.6 bolts per connection
- 2-M16 Grade 8.8 bolts per connection

IMPORTANT

The adequacy of multispan system is very sensitive to actual applied loads. The stated loads in this table are assumed uniform over the full purlin system. Variations in actual project design loadings over the length of the purlin system must be checked specifically by the designer to verify system adequacy.

THREE SPAN CONTINUOUS

LOAD TABLE – Uniformly Distributed Load

MSS 275/15								
SPAN (m)	INWARDS				OUTWARDS			
	$\phi_b w_u$ kN/m			w_s kN/m	$\phi_b w_u$ kN/m			w_s kN/m
	1B	2B	3B		1B	2B	3B	
3.0								
3.5								
4.0								
4.5	7.67	7.67	7.67	18.82	7.67	7.67	7.67	18.82
5.0	6.49	6.49	6.49	13.72	6.49	6.49	6.49	13.72
5.5	5.55	5.55	5.55	10.31	5.55	5.55	5.55	10.31
6.0	4.81	4.81	4.81	7.94	4.81	4.81	4.81	7.94
6.5	4.19	4.19	4.19	6.25	4.19	4.19	4.19	6.25
7.0	3.69	3.69	3.69	5.00	3.69	3.69	3.69	5.00
7.5	3.26	3.26	3.26	4.07	3.26	3.26	3.26	4.07
8.0	2.91	2.91	2.91	3.35	2.82	2.91	2.91	3.35
8.5	2.59	2.61	2.60	2.79	2.44	2.61	2.60	2.79
9.0	2.30	2.33	2.33	2.35	2.12	2.33	2.33	2.35
9.5	2.05	2.09	2.09	2.00	1.85	2.09	2.09	2.00
10.0	1.83	1.89	1.89	1.72	1.62	1.86	1.89	1.72
10.5	1.65	1.71	1.71	1.48	1.42	1.67	1.71	1.48
11.0	1.50	1.56	1.56	1.29	1.25	1.50	1.56	1.29
11.5	1.36	1.43	1.43	1.13	1.10	1.35	1.43	1.13
12.0	1.24	1.31	1.31	0.99	0.96	1.22	1.31	0.99
12.5	1.14	1.21	1.21	0.88	0.85	1.10	1.19	0.88
13.0	1.04	1.12	1.12	0.78	0.74	1.00	1.09	0.78
13.5	0.96	1.03	1.03	0.70	0.66	0.90	1.00	0.70
14.0	0.88	0.96	0.96	0.63	0.59	0.82	0.92	0.63
14.5	0.82	0.89	0.90	0.56	0.52	0.75	0.84	0.56
15.0	0.76	0.83	0.84	0.51	0.47	0.68	0.78	0.51
15.5	0.70	0.77	0.78	0.46	0.42	0.62	0.72	0.46
16.0	0.66	0.72	0.74	0.42	0.37	0.56	0.66	0.42
16.5	0.61	0.67	0.69	0.38	0.33	0.51	0.61	0.38
17.0	0.57	0.63	0.65	0.35	0.30	0.47	0.57	0.35
17.5								
18.0								

MSS 275/18								
SPAN (m)	INWARDS				OUTWARDS			
	$\phi_b w_u$ kN/m			w_s kN/m	$\phi_b w_u$ kN/m			w_s kN/m
	1B	2B	3B		1B	2B	3B	
3.0								
3.5								
4.0								
4.5	9.78	9.78	9.77	22.56	9.78	9.78	9.77	22.56
5.0	8.80	8.80	8.80	16.45	8.80	8.80	8.80	16.45
5.5	7.50	7.50	7.50	12.36	7.50	7.50	7.50	12.36
6.0	6.37	6.37	6.37	9.52	6.37	6.37	6.37	9.52
6.5	5.43	5.43	5.43	7.49	5.43	5.43	5.43	7.49
7.0	4.68	4.68	4.68	5.99	4.68	4.68	4.68	5.99
7.5	4.08	4.08	4.08	4.87	4.08	4.08	4.08	4.87
8.0	3.58	3.58	3.58	4.02	3.58	3.58	3.58	4.02
8.5	3.17	3.17	3.17	3.35	3.16	3.17	3.17	3.35
9.0	2.83	2.83	2.83	2.82	2.76	2.83	2.83	2.82
9.5	2.54	2.54	2.54	2.40	2.42	2.54	2.54	2.40
10.0	2.29	2.29	2.29	2.06	2.13	2.29	2.29	2.06
10.5	2.08	2.08	2.08	1.78	1.88	2.08	2.08	1.78
11.0	1.90	1.90	1.90	1.54	1.66	1.90	1.90	1.54
11.5	1.73	1.73	1.73	1.35	1.47	1.73	1.73	1.35
12.0	1.58	1.59	1.59	1.19	1.30	1.58	1.59	1.19
12.5	1.44	1.47	1.47	1.05	1.15	1.43	1.47	1.05
13.0	1.33	1.36	1.36	0.94	1.00	1.30	1.36	0.94
13.5	1.22	1.26	1.26	0.84	0.88	1.18	1.26	0.84
14.0	1.13	1.17	1.17	0.75	0.77	1.08	1.17	0.75
14.5	1.04	1.09	1.09	0.67	0.67	0.99	1.09	0.67
15.0	0.97	1.02	1.02	0.61	0.60	0.90	1.01	0.61
15.5	0.90	0.95	0.95	0.55	0.53	0.83	0.93	0.55
16.0	0.84	0.90	0.90	0.50	0.47	0.76	0.86	0.50
16.5	0.78	0.84	0.84	0.46	0.42	0.69	0.80	0.46
17.0	0.73	0.79	0.79	0.42	0.37	0.64	0.74	0.42
17.5								
18.0								

- 1B = One mid span brace
- 2B = Two equally spaced braces within the span
- 3B = Three equally spaced braces within the span
- w_s = Uniformly distributed serviceability load (kN/m) for deflection limit of Span/150
- $\phi_b w_u$ = Strength load resistance applied at the centroid (kN/m)

- 2-M12 Grade 4.6 bolts per connection
- 2-M12 Grade 8.8 bolts per connection
- 2-M16 Grade 4.6 bolts per connection
- 2-M16 Grade 8.8 bolts per connection

IMPORTANT

The adequacy of multispan system is very sensitive to actual applied loads. The stated loads in this table are assumed uniform over the full purlin system. Variations in actual project design loadings over the length of the purlin system must be checked specifically by the designer to verify system adequacy.

THREE SPAN CONTINUOUS

LOAD TABLE – Uniformly Distributed Load

MSS 300/15								
SPAN (m)	INWARDS				OUTWARDS			
	$\phi_b w_u$ kN/m			w_s kN/m	$\phi_b w_u$ kN/m			w_s kN/m
	1B	2B	3B		1B	2B	3B	
3.0								
3.5								
4.0								
4.5								
5.0	6.62	6.62	6.62	18.05	6.62	6.62	6.62	18.05
5.5	5.73	5.72	5.72	13.56	5.73	5.72	5.72	13.56
6.0	5.00	5.00	5.00	10.44	5.00	5.00	5.00	10.44
6.5	4.40	4.40	4.40	8.21	4.40	4.40	4.40	8.21
7.0	3.90	3.90	3.90	6.58	3.90	3.90	3.90	6.58
7.5	3.47	3.47	3.47	5.35	3.47	3.47	3.47	5.35
8.0	3.11	3.11	3.11	4.41	3.11	3.11	3.11	4.41
8.5	2.80	2.80	2.80	3.67	2.80	2.80	2.80	3.67
9.0	2.54	2.54	2.54	3.09	2.54	2.54	2.54	3.09
9.5	2.31	2.31	2.31	2.63	2.24	2.31	2.31	2.63
10.0	2.10	2.10	2.10	2.26	1.98	2.10	2.10	2.26
10.5	1.92	1.93	1.93	1.95	1.75	1.93	1.93	1.95
11.0	1.73	1.77	1.77	1.69	1.55	1.77	1.77	1.69
11.5	1.58	1.63	1.63	1.48	1.38	1.61	1.63	1.48
12.0	1.44	1.51	1.51	1.31	1.23	1.46	1.51	1.31
12.5	1.32	1.39	1.39	1.15	1.09	1.32	1.39	1.15
13.0	1.21	1.29	1.29	1.03	0.97	1.21	1.29	1.03
13.5	1.11	1.20	1.20	0.92	0.86	1.10	1.19	0.92
14.0	1.03	1.11	1.11	0.82	0.77	1.01	1.10	0.82
14.5	0.95	1.03	1.04	0.74	0.68	0.92	1.01	0.74
15.0	0.88	0.96	0.97	0.67	0.61	0.84	0.93	0.67
15.5	0.82	0.90	0.91	0.61	0.55	0.77	0.86	0.61
16.0	0.77	0.84	0.85	0.55	0.49	0.71	0.80	0.55
16.5	0.71	0.79	0.80	0.50	0.44	0.65	0.74	0.50
17.0	0.67	0.74	0.75	0.46	0.40	0.60	0.69	0.46
17.5	0.63	0.69	0.71	0.42	0.36	0.55	0.64	0.42
18.0	0.59	0.65	0.67	0.39	0.33	0.51	0.60	0.39

MSS 300/18								
SPAN (m)	INWARDS				OUTWARDS			
	$\phi_b w_u$ kN/m			w_s kN/m	$\phi_b w_u$ kN/m			w_s kN/m
	1B	2B	3B		1B	2B	3B	
3.0								
3.5								
4.0								
4.5								
5.0	8.80	8.80	8.80	21.64	8.80	8.80	8.80	21.64
5.5	7.98	7.98	7.97	16.26	7.98	7.98	7.97	16.26
6.0	6.91	6.91	6.91	12.53	6.91	6.91	6.91	12.53
6.5	6.03	6.03	6.03	9.85	6.03	6.03	6.03	9.85
7.0	5.31	5.31	5.31	7.89	5.31	5.31	5.31	7.89
7.5	4.71	4.71	4.70	6.41	4.71	4.71	4.70	6.41
8.0	4.15	4.15	4.15	5.28	4.15	4.15	4.15	5.28
8.5	3.68	3.68	3.68	4.41	3.68	3.68	3.68	4.41
9.0	3.28	3.28	3.28	3.71	3.28	3.28	3.28	3.71
9.5	2.94	2.94	2.94	3.16	2.89	2.94	2.94	3.16
10.0	2.66	2.66	2.66	2.71	2.56	2.66	2.66	2.71
10.5	2.41	2.41	2.41	2.34	2.27	2.41	2.41	2.34
11.0	2.20	2.20	2.20	2.03	2.02	2.20	2.20	2.03
11.5	2.00	2.01	2.01	1.78	1.81	2.01	2.01	1.78
12.0	1.82	1.84	1.84	1.57	1.61	1.84	1.84	1.57
12.5	1.67	1.70	1.70	1.39	1.44	1.70	1.70	1.39
13.0	1.53	1.57	1.57	1.23	1.29	1.56	1.57	1.23
13.5	1.41	1.46	1.46	1.10	1.16	1.42	1.46	1.10
14.0	1.30	1.36	1.36	0.99	1.03	1.30	1.36	0.99
14.5	1.21	1.26	1.26	0.89	0.92	1.20	1.26	0.89
15.0	1.12	1.18	1.18	0.80	0.83	1.10	1.18	0.80
15.5	1.04	1.11	1.11	0.73	0.74	1.01	1.11	0.73
16.0	0.97	1.04	1.04	0.66	0.66	0.93	1.03	0.66
16.5	0.91	0.98	0.98	0.60	0.59	0.86	0.96	0.60
17.0	0.85	0.92	0.92	0.55	0.52	0.79	0.90	0.55
17.5	0.80	0.87	0.87	0.50	0.47	0.73	0.83	0.50
18.0	0.75	0.82	0.82	0.46	0.42	0.67	0.78	0.46

- 1B = One mid span brace
- 2B = Two equally spaced braces within the span
- 3B = Three equally spaced braces within the span
- w_s = Uniformly distributed serviceability load (kN/m) for deflection limit of Span/150
- $\phi_b w_u$ = Strength load resistance applied at the centroid (kN/m)

- 2-M12 Grade 4.6 bolts per connection
- 2-M12 Grade 8.8 bolts per connection
- 2-M16 Grade 4.6 bolts per connection
- 2-M16 Grade 8.8 bolts per connection

IMPORTANT

The adequacy of multispan system is very sensitive to actual applied loads. The stated loads in this table are assumed uniform over the full purlin system. Variations in actual project design loadings over the length of the purlin system must be checked specifically by the designer to verify system adequacy.

THREE SPAN CONTINUOUS

LOAD TABLE – Uniformly Distributed Load

MSS 300/23								
SPAN (m)	INWARDS				OUTWARDS			
	$\phi_b w_u$ kN/m			w_s kN/m	$\phi_b w_u$ kN/m			w_s kN/m
	1B	2B	3B		1B	2B	3B	
3.0								
3.5								
4.0								
4.5								
5.0	11.3	11.3	11.3	27.53	11.3	11.3	11.3	11.3
5.5	10.3	10.3	10.3	20.69	10.3	10.3	10.3	10.3
6.0	9.43	9.43	9.43	15.93	9.43	9.43	9.43	9.43
6.5	8.70	8.70	8.69	12.53	8.70	8.70	8.69	8.69
7.0	7.65	7.65	7.65	10.03	7.65	7.65	7.65	7.65
7.5	6.66	6.66	6.66	8.16	6.66	6.66	6.66	6.66
8.0	5.85	5.85	5.85	6.72	5.85	5.85	5.85	5.85
8.5	5.19	5.19	5.19	5.60	5.19	5.19	5.19	5.19
9.0	4.63	4.63	4.63	4.72	4.63	4.63	4.63	4.63
9.5	4.15	4.15	4.15	4.01	4.15	4.15	4.15	4.15
10.0	3.75	3.75	3.75	3.44	3.75	3.75	3.75	3.75
10.5	3.40	3.40	3.40	2.97	3.40	3.40	3.40	3.40
11.0	3.10	3.10	3.10	2.59	3.01	3.10	3.10	3.10
11.5	2.83	2.83	2.83	2.26	2.66	2.83	2.83	2.83
12.0	2.60	2.60	2.60	1.99	2.36	2.60	2.60	2.60
12.5	2.40	2.40	2.40	1.76	2.09	2.40	2.40	2.40
13.0	2.22	2.22	2.22	1.57	1.85	2.22	2.22	2.22
13.5	2.05	2.06	2.06	1.40	1.64	2.06	2.06	2.06
14.0	1.89	1.91	1.91	1.25	1.45	1.91	1.91	1.91
14.5	1.74	1.78	1.78	1.13	1.28	1.78	1.78	1.78
15.0	1.61	1.67	1.67	1.02	1.13	1.64	1.67	1.67
15.5	1.49	1.56	1.56	0.92	1.00	1.50	1.56	1.56
16.0	1.39	1.46	1.46	0.84	0.89	1.38	1.46	1.46
16.5	1.29	1.38	1.38	0.77	0.79	1.26	1.38	1.38
17.0	1.20	1.30	1.30	0.70	0.70	1.15	1.30	1.30
17.5	1.12	1.22	1.22	0.64	0.63	1.06	1.22	1.22
18.0	1.05	1.16	1.16	0.59	0.56	0.97	1.16	1.16

MSS 300/24								
SPAN (m)	INWARDS				OUTWARDS			
	$\phi_b w_u$ kN/m			w_s kN/m	$\phi_b w_u$ kN/m			w_s kN/m
	1B	2B	3B		1B	2B	3B	
3.0								
3.5								
4.0								
4.5								
5.0	12.1	12.1	12.1	29.30	12.1	12.1	12.1	29.30
5.5	11.0	11.0	11.0	22.02	11.0	11.0	11.0	22.02
6.0	10.1	10.1	10.1	16.96	10.1	10.1	10.1	16.96
6.5	9.27	9.28	9.27	13.34	9.27	9.28	9.27	13.34
7.0	8.37	8.37	8.37	10.68	8.37	8.37	8.37	10.68
7.5	7.29	7.29	7.29	8.68	7.29	7.29	7.29	8.68
8.0	6.41	6.41	6.41	7.15	6.41	6.41	6.41	7.15
8.5	5.67	5.67	5.67	5.96	5.67	5.67	5.67	5.96
9.0	5.06	5.06	5.06	5.02	5.06	5.06	5.06	5.02
9.5	4.54	4.54	4.54	4.27	4.54	4.54	4.54	4.27
10.0	4.10	4.10	4.10	3.66	4.10	4.10	4.10	3.66
10.5	3.72	3.72	3.72	3.16	3.67	3.72	3.72	3.16
11.0	3.39	3.39	3.39	2.75	3.25	3.39	3.39	2.75
11.5	3.10	3.10	3.10	2.41	2.87	3.10	3.10	2.41
12.0	2.85	2.85	2.85	2.12	2.55	2.85	2.85	2.12
12.5	2.61	2.62	2.62	1.88	2.26	2.62	2.62	1.88
13.0	2.39	2.43	2.43	1.67	2.00	2.43	2.43	1.67
13.5	2.19	2.25	2.25	1.49	1.77	2.25	2.25	1.49
14.0	2.01	2.09	2.09	1.33	1.57	2.09	2.09	1.33
14.5	1.86	1.95	1.95	1.20	1.38	1.93	1.95	1.20
15.0	1.72	1.82	1.82	1.09	1.21	1.77	1.82	1.09
15.5	1.59	1.71	1.71	0.98	1.07	1.62	1.71	0.98
16.0	1.48	1.60	1.60	0.89	0.94	1.49	1.60	0.89
16.5	1.38	1.51	1.51	0.82	0.84	1.36	1.51	0.82
17.0	1.28	1.42	1.42	0.75	0.75	1.25	1.42	0.75
17.5	1.20	1.34	1.34	0.68	0.67	1.14	1.34	0.68
18.0	1.12	1.27	1.27	0.63	0.60	1.05	1.26	0.63

- 1B = One mid span brace
- 2B = Two equally spaced braces within the span
- 3B = Three equally spaced braces within the span
- w_s = Uniformly distributed serviceability load (kN/m) for deflection limit of Span/150
- $\phi_b w_u$ = Strength load resistance applied at the centroid (kN/m)

- 2-M12 Grade 4.6 bolts per connection
- 2-M12 Grade 8.8 bolts per connection
- 2-M16 Grade 4.6 bolts per connection
- 2-M16 Grade 8.8 bolts per connection

IMPORTANT

The adequacy of multispan system is very sensitive to actual applied loads. The stated loads in this table are assumed uniform over the full purlin system. Variations in actual project design loadings over the length of the purlin system must be checked specifically by the designer to verify system adequacy.

THREE SPAN CONTINUOUS

LOAD TABLE – Uniformly Distributed Load

MSS 300/30								
SPAN (m)	INWARDS				OUTWARDS			
	$\phi_b w_u$ kN/m			W_s kN/m	$\phi_b w_u$ kN/m			W_s kN/m
	1B	2B	3B		1B	2B	3B	
3.0								
3.5								
4.0								
4.5								
5.0	14.8	14.8	14.8	35.61	14.8	14.8	14.8	35.61
5.5	13.5	13.5	13.5	26.76	13.5	13.5	13.5	26.76
6.0	12.4	12.4	12.4	20.61	12.4	12.4	12.4	20.61
6.5	11.4	11.4	11.4	16.21	11.4	11.4	11.4	16.21
7.0	10.6	10.6	10.6	12.98	10.6	10.6	10.6	12.98
7.5	9.58	9.58	9.58	10.55	9.58	9.58	9.58	10.55
8.0	8.42	8.42	8.42	8.69	8.42	8.42	8.42	8.69
8.5	7.46	7.46	7.46	7.25	7.46	7.46	7.46	7.25
9.0	6.65	6.65	6.65	6.11	6.65	6.65	6.65	6.11
9.5	5.97	5.97	5.97	5.19	5.97	5.97	5.97	5.19
10.0	5.39	5.39	5.39	4.45	5.32	5.39	5.39	4.45
10.5	4.86	4.89	4.89	3.85	4.67	4.89	4.89	3.85
11.0	4.36	4.45	4.45	3.34	4.11	4.45	4.45	3.34
11.5	3.92	4.07	4.07	2.93	3.62	4.07	4.07	2.93
12.0	3.55	3.74	3.74	2.58	3.20	3.74	3.74	2.58
12.5	3.22	3.45	3.45	2.28	2.82	3.45	3.45	2.28
13.0	2.93	3.19	3.19	2.03	2.49	3.19	3.19	2.03
13.5	2.68	2.96	2.96	1.81	2.19	2.96	2.96	1.81
14.0	2.45	2.75	2.75	1.62	1.93	2.70	2.75	1.62
14.5	2.25	2.56	2.56	1.46	1.70	2.46	2.56	1.46
15.0	2.07	2.40	2.40	1.32	1.49	2.25	2.40	1.32
15.5	1.91	2.24	2.24	1.20	1.31	2.05	2.24	1.20
16.0	1.77	2.11	2.11	1.09	1.16	1.87	2.11	1.09
16.5	1.64	1.98	1.98	0.99	1.03	1.71	1.98	0.99
17.0	1.53	1.86	1.86	0.91	0.92	1.56	1.86	0.91
17.5	1.42	1.76	1.76	0.83	0.82	1.43	1.73	0.83
18.0	1.32	1.66	1.66	0.76	0.74	1.30	1.61	0.76

MSS 325/15								
SPAN (m)	INWARDS				OUTWARDS			
	$\phi_b w_u$ kN/m			W_s kN/m	$\phi_b w_u$ kN/m			W_s kN/m
	1B	2B	3B		1B	2B	3B	
3.0								
3.5								
4.0								
4.5								
5.0	6.80	6.80	6.80	21.78	6.80	6.80	6.80	21.78
5.5	5.91	5.91	5.91	16.37	5.91	5.91	5.91	16.37
6.0	5.19	5.19	5.19	12.61	5.19	5.19	5.19	12.61
6.5	4.58	4.58	4.58	9.91	4.58	4.58	4.58	9.91
7.0	4.08	4.08	4.08	7.94	4.08	4.08	4.08	7.94
7.5	3.64	3.64	3.64	6.45	3.64	3.64	3.64	6.45
8.0	3.28	3.28	3.28	5.32	3.28	3.28	3.28	5.32
8.5	2.96	2.96	2.96	4.43	2.96	2.96	2.96	4.43
9.0	2.69	2.69	2.69	3.74	2.69	2.69	2.69	3.74
9.5	2.45	2.45	2.45	3.18	2.44	2.45	2.45	3.18
10.0	2.24	2.24	2.24	2.72	2.15	2.24	2.24	2.72
10.5	2.05	2.05	2.05	2.35	1.90	2.05	2.05	2.35
11.0	1.88	1.89	1.89	2.05	1.68	1.89	1.89	2.05
11.5	1.71	1.74	1.74	1.79	1.49	1.74	1.74	1.79
12.0	1.56	1.62	1.62	1.58	1.33	1.59	1.62	1.58
12.5	1.43	1.50	1.50	1.39	1.18	1.44	1.50	1.39
13.0	1.31	1.40	1.40	1.24	1.05	1.31	1.40	1.24
13.5	1.21	1.30	1.30	1.11	0.93	1.20	1.29	1.11
14.0	1.12	1.21	1.21	0.99	0.83	1.09	1.19	0.99
14.5	1.03	1.12	1.12	0.89	0.73	1.00	1.10	0.89
15.0	0.96	1.05	1.05	0.81	0.65	0.92	1.02	0.81
15.5	0.89	0.98	0.98	0.73	0.59	0.84	0.94	0.73
16.0	0.83	0.92	0.92	0.66	0.53	0.77	0.87	0.66
16.5	0.77	0.86	0.87	0.61	0.48	0.71	0.81	0.61
17.0	0.72	0.80	0.82	0.55	0.43	0.65	0.75	0.55
17.5	0.68	0.75	0.77	0.51	0.39	0.60	0.70	0.51
18.0	0.63	0.71	0.73	0.47	0.36	0.55	0.65	0.47

- 1B = One mid span brace
- 2B = Two equally spaced braces within the span
- 3B = Three equally spaced braces within the span
- w_s = Uniformly distributed serviceability load (kN/m) for deflection limit of Span/150
- $\phi_b w_u$ = Strength load resistance applied at the centroid (kN/m)

- 2-M12 Grade 4.6 bolts per connection
- 2-M12 Grade 8.8 bolts per connection
- 2-M16 Grade 4.6 bolts per connection
- 2-M16 Grade 8.8 bolts per connection

IMPORTANT

The adequacy of multispan system is very sensitive to actual applied loads. The stated loads in this table are assumed uniform over the full purlin system. Variations in actual project design loadings over the length of the purlin system must be checked specifically by the designer to verify system adequacy.

THREE SPAN CONTINUOUS

LOAD TABLE – Uniformly Distributed Load

MSS 325/18								
SPAN (m)	INWARDS				OUTWARDS			
	$\phi_b w_u$ kN/m			w_s kN/m	$\phi_b w_u$ kN/m			w_s kN/m
	1B	2B	3B		1B	2B	3B	
3.0								
3.5								
4.0								
4.5								
5.0	8.80	8.80	8.80	26.14	8.80	8.80	8.80	26.14
5.5	7.99	8.00	7.98	19.64	7.99	8.00	7.98	19.64
6.0	7.23	7.23	7.23	15.13	7.23	7.23	7.23	15.13
6.5	6.34	6.34	6.34	11.90	6.34	6.34	6.34	11.90
7.0	5.60	5.60	5.60	9.53	5.60	5.60	5.60	9.53
7.5	4.98	4.98	4.98	7.75	4.98	4.98	4.98	7.75
8.0	4.45	4.45	4.45	6.38	4.45	4.45	4.45	6.38
8.5	3.99	3.99	3.99	5.32	3.99	3.99	3.99	5.32
9.0	3.56	3.56	3.56	4.48	3.56	3.56	3.56	4.48
9.5	3.20	3.20	3.20	3.81	3.14	3.20	3.20	3.81
10.0	2.89	2.89	2.89	3.27	2.78	2.89	2.89	3.27
10.5	2.62	2.62	2.62	2.82	2.46	2.62	2.62	2.82
11.0	2.38	2.38	2.38	2.45	2.19	2.38	2.38	2.45
11.5	2.16	2.18	2.18	2.15	1.96	2.18	2.18	2.15
12.0	1.97	2.00	2.00	1.89	1.75	2.00	2.00	1.89
12.5	1.80	1.85	1.85	1.67	1.56	1.85	1.85	1.67
13.0	1.66	1.71	1.71	1.49	1.39	1.69	1.71	1.49
13.5	1.53	1.58	1.58	1.33	1.24	1.54	1.58	1.33
14.0	1.41	1.47	1.47	1.19	1.11	1.41	1.47	1.19
14.5	1.31	1.37	1.37	1.07	0.99	1.30	1.37	1.07
15.0	1.21	1.28	1.28	0.97	0.89	1.19	1.28	0.97
15.5	1.13	1.20	1.20	0.88	0.80	1.10	1.20	0.88
16.0	1.05	1.13	1.13	0.80	0.72	1.01	1.12	0.80
16.5	0.98	1.06	1.06	0.73	0.65	0.93	1.04	0.73
17.0	0.92	1.00	1.00	0.67	0.58	0.86	0.97	0.67
17.5	0.86	0.94	0.94	0.61	0.52	0.79	0.91	0.61
18.0	0.81	0.89	0.89	0.56	0.47	0.73	0.84	0.56

MSS 350/18								
SPAN (m)	INWARDS				OUTWARDS			
	$\phi_b w_u$ kN/m			w_s kN/m	$\phi_b w_u$ kN/m			w_s kN/m
	1B	2B	3B		1B	2B	3B	
3.0								
3.5								
4.0								
4.5								
5.0								
5.5								
6.0	7.02	7.02	7.02	18.31	7.02	7.02	7.02	18.31
6.5	6.21	6.21	6.21	14.40	6.21	6.21	6.21	14.40
7.0	5.54	5.54	5.54	11.53	5.54	5.54	5.54	11.53
7.5	4.96	4.96	4.95	9.38	4.96	4.96	4.95	9.38
8.0	4.47	4.47	4.47	7.73	4.47	4.47	4.47	7.73
8.5	4.04	4.04	4.04	6.44	4.04	4.04	4.04	6.44
9.0	3.67	3.67	3.67	5.43	3.67	3.67	3.67	5.43
9.5	3.35	3.35	3.35	4.61	3.35	3.35	3.35	4.61
10.0	3.06	3.06	3.06	3.96	3.06	3.06	3.06	3.96
10.5	2.81	2.81	2.81	3.42	2.76	2.81	2.81	3.42
11.0	2.59	2.59	2.59	2.97	2.45	2.59	2.59	2.97
11.5	2.39	2.39	2.39	2.60	2.19	2.39	2.39	2.60
12.0	2.19	2.22	2.22	2.29	1.95	2.22	2.22	2.29
12.5	2.00	2.06	2.06	2.03	1.75	2.06	2.06	2.03
13.0	1.84	1.91	1.91	1.80	1.56	1.88	1.91	1.80
13.5	1.69	1.77	1.77	1.61	1.40	1.73	1.77	1.61
14.0	1.56	1.65	1.65	1.44	1.25	1.58	1.65	1.44
14.5	1.44	1.53	1.53	1.30	1.12	1.45	1.53	1.30
15.0	1.34	1.43	1.43	1.17	1.00	1.33	1.43	1.17
15.5	1.24	1.34	1.34	1.06	0.90	1.23	1.34	1.06
16.0	1.16	1.26	1.26	0.97	0.81	1.13	1.25	0.97
16.5	1.08	1.19	1.19	0.88	0.73	1.04	1.17	0.88
17.0	1.01	1.12	1.12	0.81	0.66	0.96	1.09	0.81
17.5	0.95	1.05	1.05	0.74	0.60	0.89	1.01	0.74
18.0	0.89	0.99	1.00	0.68	0.54	0.82	0.95	0.68

- 1B = One mid span brace
- 2B = Two equally spaced braces within the span
- 3B = Three equally spaced braces within the span
- w_s = Uniformly distributed serviceability load (kN/m) for deflection limit of Span/150
- $\phi_b w_u$ = Strength load resistance applied at the centroid (kN/m)

- 2-M12 Grade 4.6 bolts per connection
- 2-M12 Grade 8.8 bolts per connection
- 2-M16 Grade 4.6 bolts per connection
- 2-M16 Grade 8.8 bolts per connection

IMPORTANT

The adequacy of multispan system is very sensitive to actual applied loads. The stated loads in this table are assumed uniform over the full purlin system. Variations in actual project design loadings over the length of the purlin system must be checked specifically by the designer to verify system adequacy.

THREE SPAN CONTINUOUS

LOAD TABLE – Uniformly Distributed Load

MSS 350/23								
SPAN (m)	INWARDS				OUTWARDS			
	$\phi_b w_u$ kN/m			W_s kN/m	$\phi_b w_u$ kN/m			W_s kN/m
	1B	2B	3B		1B	2B	3B	
3.0								
3.5								
4.0								
4.5								
5.0								
5.5								
6.0	9.43	9.43	9.43	23.33	9.43	9.43	9.43	23.33
6.5	8.70	8.70	8.69	18.35	8.70	8.70	8.69	18.35
7.0	8.08	8.08	8.08	14.69	8.08	8.08	8.08	14.69
7.5	7.54	7.54	7.53	11.94	7.54	7.54	7.53	11.94
8.0	7.07	7.07	7.07	9.84	7.07	7.07	7.07	9.84
8.5	6.31	6.31	6.31	8.20	6.31	6.31	6.31	8.20
9.0	5.63	5.63	5.63	6.91	5.63	5.63	5.63	6.91
9.5	5.05	5.05	5.05	5.88	5.05	5.05	5.05	5.88
10.0	4.56	4.56	4.56	5.04	4.56	4.56	4.56	5.04
10.5	4.14	4.14	4.14	4.35	4.10	4.14	4.14	4.35
11.0	3.77	3.77	3.77	3.79	3.65	3.77	3.77	3.79
11.5	3.45	3.45	3.45	3.31	3.26	3.45	3.45	3.31
12.0	3.17	3.17	3.17	2.92	2.91	3.17	3.17	2.92
12.5	2.90	2.92	2.92	2.58	2.61	2.92	2.92	2.58
13.0	2.65	2.70	2.70	2.29	2.34	2.70	2.70	2.29
13.5	2.44	2.50	2.50	2.05	2.09	2.50	2.50	2.05
14.0	2.25	2.33	2.33	1.84	1.85	2.33	2.33	1.84
14.5	2.08	2.17	2.17	1.65	1.64	2.16	2.17	1.65
15.0	1.92	2.03	2.03	1.49	1.45	1.99	2.03	1.49
15.5	1.79	1.90	1.90	1.35	1.28	1.83	1.90	1.35
16.0	1.66	1.78	1.78	1.23	1.14	1.68	1.78	1.23
16.5	1.55	1.67	1.67	1.12	1.01	1.55	1.67	1.12
17.0	1.45	1.58	1.58	1.03	0.90	1.43	1.58	1.03
17.5	1.36	1.49	1.49	0.94	0.80	1.33	1.49	0.94
18.0	1.27	1.41	1.41	0.86	0.72	1.23	1.41	0.86

MSS 350/24								
SPAN (m)	INWARDS				OUTWARDS			
	$\phi_b w_u$ kN/m			W_s kN/m	$\phi_b w_u$ kN/m			W_s kN/m
	1B	2B	3B		1B	2B	3B	
3.0								
3.5								
4.0								
4.5								
5.0								
5.5								
6.0	10.1	10.1	10.1	24.81	10.1	10.1	10.1	24.81
6.5	9.27	9.28	9.27	19.51	9.27	9.28	9.27	19.51
7.0	8.62	8.62	8.62	15.62	8.62	8.62	8.62	15.62
7.5	8.04	8.04	8.03	12.70	8.04	8.04	8.03	12.70
8.0	7.54	7.54	7.54	10.47	7.54	7.54	7.54	10.47
8.5	6.89	6.89	6.89	8.73	6.89	6.89	6.89	8.73
9.0	6.15	6.15	6.15	7.35	6.15	6.15	6.15	7.35
9.5	5.52	5.52	5.52	6.25	5.52	5.52	5.52	6.25
10.0	4.98	4.98	4.98	5.36	4.98	4.98	4.98	5.36
10.5	4.52	4.52	4.52	4.63	4.52	4.52	4.52	4.63
11.0	4.11	4.11	4.11	4.03	4.06	4.11	4.11	4.03
11.5	3.76	3.76	3.76	3.52	3.62	3.76	3.76	3.52
12.0	3.46	3.46	3.46	3.10	3.24	3.46	3.46	3.10
12.5	3.19	3.19	3.19	2.74	2.87	3.19	3.19	2.74
13.0	2.93	2.95	2.95	2.44	2.55	2.95	2.95	2.44
13.5	2.69	2.73	2.73	2.18	2.26	2.73	2.73	2.18
14.0	2.48	2.54	2.54	1.95	2.00	2.54	2.54	1.95
14.5	2.29	2.37	2.37	1.76	1.77	2.37	2.37	1.76
15.0	2.12	2.21	2.21	1.59	1.56	2.21	2.21	1.59
15.5	1.97	2.07	2.07	1.44	1.37	2.03	2.07	1.44
16.0	1.83	1.94	1.94	1.31	1.21	1.87	1.94	1.31
16.5	1.70	1.83	1.83	1.19	1.07	1.73	1.83	1.19
17.0	1.58	1.72	1.72	1.09	0.95	1.59	1.72	1.09
17.5	1.48	1.63	1.63	1.00	0.85	1.46	1.63	1.00
18.0	1.38	1.54	1.54	0.92	0.76	1.34	1.54	0.92

- 1B = One mid span brace
- 2B = Two equally spaced braces within the span
- 3B = Three equally spaced braces within the span
- w_s = Uniformly distributed serviceability load (kN/m) for deflection limit of Span/150
- $\phi_b w_u$ = Strength load resistance applied at the centroid (kN/m)

- 2-M12 Grade 4.6 bolts per connection
- 2-M12 Grade 8.8 bolts per connection
- 2-M16 Grade 4.6 bolts per connection
- 2-M16 Grade 8.8 bolts per connection

IMPORTANT

The adequacy of multispan system is very sensitive to actual applied loads. The stated loads in this table are assumed uniform over the full purlin system. Variations in actual project design loadings over the length of the purlin system must be checked specifically by the designer to verify system adequacy.

THREE SPAN CONTINUOUS

LOAD TABLE – Uniformly Distributed Load

MSS 350/30								
SPAN (m)	INWARDS				OUTWARDS			
	$\phi_b w_u$ kN/m			w_s kN/m	$\phi_b w_u$ kN/m			w_s kN/m
	1B	2B	3B		1B	2B	3B	
3.0								
3.5								
4.0								
4.5								
5.0								
5.5								
6.0	12.4	12.4	12.4	30.20	12.4	12.4	12.4	30.20
6.5	11.4	11.4	11.4	23.75	11.4	11.4	11.4	23.75
7.0	10.6	10.6	10.6	19.02	10.6	10.6	10.6	19.02
7.5	9.88	9.89	9.87	15.46	9.88	9.89	9.87	15.46
8.0	9.27	9.27	9.27	12.74	9.27	9.27	9.27	12.74
8.5	8.72	8.72	8.71	10.62	8.72	8.72	8.71	10.62
9.0	8.11	8.11	8.11	8.95	8.11	8.11	8.11	8.95
9.5	7.28	7.28	7.28	7.61	7.28	7.28	7.28	7.61
10.0	6.57	6.57	6.57	6.52	6.57	6.57	6.57	6.52
10.5	5.96	5.96	5.96	5.64	5.91	5.96	5.96	5.64
11.0	5.43	5.43	5.43	4.90	5.21	5.43	5.43	4.90
11.5	4.88	4.97	4.97	4.29	4.59	4.97	4.97	4.29
12.0	4.41	4.56	4.56	3.78	4.06	4.56	4.56	3.78
12.5	3.99	4.21	4.21	3.34	3.58	4.21	4.21	3.34
13.0	3.63	3.89	3.89	2.97	3.17	3.89	3.89	2.97
13.5	3.31	3.61	3.61	2.65	2.79	3.61	3.61	2.65
14.0	3.03	3.35	3.35	2.38	2.46	3.35	3.35	2.38
14.5	2.78	3.13	3.13	2.14	2.17	3.12	3.13	2.14
15.0	2.56	2.92	2.92	1.93	1.90	2.85	2.92	1.93
15.5	2.36	2.74	2.74	1.75	1.67	2.60	2.74	1.75
16.0	2.18	2.57	2.57	1.59	1.48	2.38	2.57	1.59
16.5	2.01	2.41	2.41	1.45	1.32	2.17	2.41	1.45
17.0	1.87	2.27	2.27	1.33	1.17	1.99	2.27	1.33
17.5	1.74	2.15	2.15	1.22	1.05	1.82	2.15	1.22
18.0	1.62	2.03	2.03	1.12	0.94	1.66	2.03	1.12

MSS 400/20								
SPAN (m)	INWARDS				OUTWARDS			
	$\phi_b w_u$ kN/m			w_s kN/m	$\phi_b w_u$ kN/m			w_s kN/m
	1B	2B	3B		1B	2B	3B	
3.0								
3.5								
4.0								
4.5								
5.0								
5.5								
6.0	8.08	8.08	8.08	28.33	8.08	8.08	8.08	28.33
6.5	7.24	7.23	7.23	22.29	7.24	7.23	7.23	22.29
7.0	6.52	6.52	6.52	17.84	6.52	6.52	6.52	17.84
7.5	5.90	5.90	5.90	14.51	5.90	5.90	5.90	14.51
8.0	5.37	5.37	5.37	11.95	5.37	5.37	5.37	11.95
8.5	4.90	4.90	4.89	9.97	4.90	4.90	4.89	9.97
9.0	4.49	4.49	4.49	8.40	4.49	4.49	4.49	8.40
9.5	4.12	4.12	4.12	7.14	4.12	4.12	4.12	7.14
10.0	3.80	3.80	3.80	6.12	3.80	3.80	3.80	6.12
10.5	3.51	3.51	3.51	5.29	3.51	3.51	3.51	5.29
11.0	3.25	3.25	3.25	4.60	3.25	3.25	3.25	4.60
11.5	3.02	3.02	3.02	4.02	3.02	3.02	3.02	4.02
12.0	2.82	2.82	2.82	3.54	2.71	2.82	2.82	3.54
12.5	2.63	2.63	2.63	3.13	2.42	2.63	2.63	3.13
13.0	2.46	2.46	2.46	2.79	2.17	2.46	2.46	2.79
13.5	2.26	2.30	2.30	2.49	1.94	2.30	2.30	2.49
14.0	2.09	2.16	2.16	2.23	1.74	2.16	2.16	2.23
14.5	1.93	2.03	2.03	2.01	1.55	1.98	2.03	2.01
15.0	1.79	1.91	1.91	1.81	1.39	1.83	1.91	1.81
15.5	1.67	1.80	1.80	1.64	1.25	1.69	1.80	1.64
16.0	1.55	1.70	1.70	1.49	1.12	1.56	1.70	1.49
16.5	1.45	1.60	1.60	1.36	1.01	1.44	1.59	1.36
17.0	1.36	1.51	1.51	1.25	0.92	1.33	1.48	1.25
17.5	1.27	1.42	1.43	1.14	0.83	1.23	1.38	1.14
18.0	1.19	1.34	1.35	1.05	0.76	1.14	1.29	1.05

- 1B = One mid span brace
- 2B = Two equally spaced braces within the span
- 3B = Three equally spaced braces within the span
- w_s = Uniformly distributed serviceability load (kN/m) for deflection limit of Span/150
- $\phi_b w_u$ = Strength load resistance applied at the centroid (kN/m)

- 2-M12 Grade 4.6 bolts per connection
- 2-M12 Grade 8.8 bolts per connection
- 2-M16 Grade 4.6 bolts per connection
- 2-M16 Grade 8.8 bolts per connection

IMPORTANT

The adequacy of multispan system is very sensitive to actual applied loads. The stated loads in this table are assumed uniform over the full purlin system. Variations in actual project design loadings over the length of the purlin system must be checked specifically by the designer to verify system adequacy.

THREE SPAN CONTINUOUS

LOAD TABLE – Uniformly Distributed Load

MSS 400/23								
SPAN (m)	INWARDS				OUTWARDS			
	$\phi_b w_u$ kN/m			w_s kN/m	$\phi_b w_u$ kN/m			w_s kN/m
	1B	2B	3B		1B	2B	3B	
3.0								
3.5								
4.0								
4.5								
5.0								
5.5								
6.0	9.43	9.43	9.43	32.52	9.43	9.43	9.43	32.52
6.5	8.70	8.70	8.69	25.58	8.70	8.70	8.69	25.58
7.0	8.08	8.08	8.08	20.48	8.08	8.08	8.08	20.48
7.5	7.54	7.54	7.53	16.65	7.54	7.54	7.53	16.65
8.0	7.07	7.07	7.07	13.72	7.07	7.07	7.07	13.72
8.5	6.59	6.59	6.58	11.44	6.59	6.59	6.58	11.44
9.0	6.02	6.02	6.02	9.64	6.02	6.02	6.02	9.64
9.5	5.51	5.51	5.51	8.19	5.51	5.51	5.51	8.19
10.0	5.07	5.07	5.07	7.03	5.07	5.07	5.07	7.03
10.5	4.67	4.67	4.67	6.07	4.67	4.67	4.67	6.07
11.0	4.32	4.32	4.32	5.28	4.25	4.32	4.32	5.28
11.5	4.01	4.01	4.01	4.62	3.79	4.01	4.01	4.62
12.0	3.66	3.69	3.69	4.07	3.39	3.69	3.69	4.07
12.5	3.34	3.40	3.40	3.60	3.03	3.40	3.40	3.60
13.0	3.06	3.15	3.15	3.20	2.72	3.15	3.15	3.20
13.5	2.81	2.92	2.92	2.86	2.43	2.92	2.92	2.86
14.0	2.59	2.71	2.71	2.56	2.18	2.71	2.71	2.56
14.5	2.39	2.53	2.53	2.30	1.95	2.52	2.53	2.30
15.0	2.21	2.36	2.36	2.08	1.75	2.31	2.36	2.08
15.5	2.05	2.21	2.21	1.89	1.57	2.13	2.21	1.89
16.0	1.91	2.08	2.08	1.72	1.39	1.96	2.08	1.72
16.5	1.78	1.95	1.95	1.56	1.23	1.81	1.95	1.56
17.0	1.66	1.84	1.84	1.43	1.10	1.67	1.84	1.43
17.5	1.55	1.74	1.74	1.31	0.98	1.54	1.74	1.31
18.0	1.45	1.64	1.64	1.20	0.88	1.42	1.64	1.20

MSS 400/24								
SPAN (m)	INWARDS				OUTWARDS			
	$\phi_b w_u$ kN/m			w_s kN/m	$\phi_b w_u$ kN/m			w_s kN/m
	1B	2B	3B		1B	2B	3B	
3.0								
3.5								
4.0								
4.5								
5.0								
5.5								
6.0	10.1	10.1	10.1	34.60	10.1	10.1	10.1	34.60
6.5	9.27	9.28	9.27	27.21	9.27	9.28	9.27	27.21
7.0	8.62	8.62	8.62	21.79	8.62	8.62	8.62	21.79
7.5	8.04	8.04	8.03	17.71	8.04	8.04	8.03	17.71
8.0	7.54	7.54	7.54	14.60	7.54	7.54	7.54	14.60
8.5	7.09	7.10	7.09	12.17	7.09	7.10	7.09	12.17
9.0	6.70	6.70	6.70	10.25	6.70	6.70	6.70	10.25
9.5	6.28	6.28	6.28	8.72	6.28	6.28	6.28	8.72
10.0	5.77	5.77	5.77	7.47	5.77	5.77	5.77	7.47
10.5	5.27	5.27	5.27	6.46	5.27	5.27	5.27	6.46
11.0	4.80	4.80	4.80	5.61	4.71	4.80	4.80	5.61
11.5	4.40	4.40	4.40	4.91	4.20	4.40	4.40	4.91
12.0	4.03	4.04	4.04	4.32	3.76	4.04	4.04	4.32
12.5	3.67	3.72	3.72	3.83	3.36	3.72	3.72	3.83
13.0	3.36	3.44	3.44	3.40	3.01	3.44	3.44	3.40
13.5	3.08	3.19	3.19	3.04	2.70	3.19	3.19	3.04
14.0	2.84	2.97	2.97	2.72	2.42	2.97	2.97	2.72
14.5	2.62	2.76	2.76	2.45	2.17	2.76	2.76	2.45
15.0	2.42	2.58	2.58	2.21	1.91	2.56	2.58	2.21
15.5	2.25	2.42	2.42	2.01	1.68	2.36	2.42	2.01
16.0	2.09	2.27	2.27	1.82	1.48	2.17	2.27	1.82
16.5	1.95	2.14	2.14	1.66	1.31	2.00	2.14	1.66
17.0	1.81	2.01	2.01	1.52	1.17	1.85	2.01	1.52
17.5	1.70	1.90	1.90	1.39	1.04	1.71	1.90	1.39
18.0	1.59	1.79	1.79	1.28	0.94	1.58	1.79	1.28

- 1B = One mid span brace
- 2B = Two equally spaced braces within the span
- 3B = Three equally spaced braces within the span
- w_s = Uniformly distributed serviceability load (kN/m) for deflection limit of Span/150
- $\phi_b w_u$ = Strength load resistance applied at the centroid (kN/m)

- 2-M12 Grade 4.6 bolts per connection
- 2-M12 Grade 8.8 bolts per connection
- 2-M16 Grade 4.6 bolts per connection
- 2-M16 Grade 8.8 bolts per connection

IMPORTANT

The adequacy of multispan system is very sensitive to actual applied loads. The stated loads in this table are assumed uniform over the full purlin system. Variations in actual project design loadings over the length of the purlin system must be checked specifically by the designer to verify system adequacy.

THREE SPAN CONTINUOUS

LOAD TABLE – Uniformly Distributed Load

MSS 400/30								
SPAN (m)	INWARDS				OUTWARDS			
	$\phi_b w_u$ kN/m			w_s kN/m	$\phi_b w_u$ kN/m			w_s kN/m
	1B	2B	3B		1B	2B	3B	
3.0								
3.5								
4.0								
4.5								
5.0								
5.5								
6.0	12.4	12.4	12.4	42.16	12.4	12.4	12.4	42.16
6.5	11.4	11.4	11.4	33.16	11.4	11.4	11.4	33.16
7.0	10.6	10.6	10.6	26.55	10.6	10.6	10.6	26.55
7.5	9.88	9.89	9.87	21.59	9.88	9.89	9.87	21.59
8.0	9.27	9.27	9.27	17.79	9.27	9.27	9.27	17.79
8.5	8.72	8.72	8.71	14.83	8.72	8.72	8.71	14.83
9.0	8.24	8.24	8.24	12.49	8.24	8.24	8.24	12.49
9.5	7.80	7.80	7.80	10.62	7.80	7.80	7.80	10.62
10.0	7.42	7.42	7.42	9.11	7.42	7.42	7.42	9.11
10.5	6.98	6.98	6.98	7.87	6.98	6.98	6.98	7.87
11.0	6.36	6.36	6.36	6.84	6.36	6.36	6.36	6.84
11.5	5.82	5.82	5.82	5.99	5.63	5.82	5.82	5.99
12.0	5.32	5.35	5.35	5.27	4.97	5.35	5.35	5.27
12.5	4.81	4.93	4.93	4.66	4.39	4.93	4.93	4.66
13.0	4.37	4.56	4.56	4.15	3.88	4.56	4.56	4.15
13.5	3.98	4.22	4.22	3.70	3.42	4.22	4.22	3.70
14.0	3.64	3.93	3.93	3.32	3.02	3.93	3.93	3.32
14.5	3.33	3.66	3.66	2.99	2.65	3.66	3.66	2.99
15.0	3.06	3.42	3.42	2.70	2.33	3.42	3.42	2.70
15.5	2.82	3.20	3.20	2.45	2.05	3.18	3.20	2.45
16.0	2.60	3.01	3.01	2.22	1.81	2.91	3.01	2.22
16.5	2.40	2.83	2.83	2.03	1.61	2.66	2.83	2.03
17.0	2.22	2.66	2.66	1.85	1.43	2.43	2.66	1.85
17.5	2.06	2.51	2.51	1.70	1.28	2.23	2.51	1.70
18.0	1.92	2.38	2.38	1.56	1.15	2.04	2.38	1.56

- 1B = One mid span brace
 2B = Two equally spaced braces within the span
 3B = Three equally spaced braces within the span
 w_s = Uniformly distributed serviceability load (kN/m) for deflection limit of Span/150
 $\phi_b w_u$ = Strength load resistance applied at the centroid (kN/m)

- 2-M12 Grade 4.6 bolts per connection
- 2-M12 Grade 8.8 bolts per connection
- 2-M16 Grade 4.6 bolts per connection
- 2-M16 Grade 8.8 bolts per connection

IMPORTANT

The adequacy of multispan system is very sensitive to actual applied loads. The stated loads in this table are assumed uniform over the full purlin system. Variations in actual project design loadings over the length of the purlin system must be checked specifically by the designer to verify system adequacy.

MULTISPAN CONTINUOUS (END SPAN)

LOAD TABLE – Uniformly Distributed Load

MSS 150/12								
SPAN (m)	INWARDS			Ws kN/m	OUTWARDS			Ws kN/m
	$\phi_b w_u$ kN/m				$\phi_b w_u$ kN/m			
	1B	2B	3B		1B	2B	3B	
3.0	5.48	5.48	5.48	Generally not limiting design - verify by calculation	5.48	5.48	5.48	Generally not limiting design - verify by calculation
3.5	4.03	4.03	4.03		4.03	4.03	4.03	
4.0	3.08	3.08	3.08		3.08	3.08	3.08	
4.5	2.44	2.44	2.44		2.44	2.44	2.44	
5.0	1.97	1.97	1.97		1.97	1.97	1.97	
5.5	1.63	1.63	1.63		1.63	1.63	1.63	
6.0	1.37	1.37	1.37		1.37	1.37	1.37	
6.5	1.17	1.17	1.17		1.17	1.17	1.17	
7.0	1.01	1.01	1.01		1.01	1.01	1.01	
7.5	0.88	0.88	0.88		0.87	0.88	0.88	
8.0	0.77	0.77	0.77		0.75	0.77	0.77	
8.5	0.68	0.68	0.68		0.64	0.68	0.68	
9.0	0.61	0.61	0.61		0.56	0.61	0.61	
9.5	0.55	0.55	0.55		0.47	0.55	0.55	
10.0	0.49	0.49	0.49		0.39	0.49	0.49	
10.5	0.45	0.45	0.45		0.33	0.44	0.45	
11.0	0.41	0.41	0.41		0.28	0.40	0.41	
11.5								
12.0								
12.5								
13.0								
13.5								
14.0								
14.5								
15.0								
15.5								
16.0								
16.5								
17.0								
17.5								
18.0								

MSS 150/15								
SPAN (m)	INWARDS			Ws kN/m	OUTWARDS			Ws kN/m
	$\phi_b w_u$ kN/m				$\phi_b w_u$ kN/m			
	1B	2B	3B		1B	2B	3B	
3.0	7.49	7.49	7.49	Generally not limiting design - verify by calculation	7.49	7.49	7.49	Generally not limiting design - verify by calculation
3.5	5.50	5.51	5.51		5.50	5.51	5.51	
4.0	4.21	4.21	4.21		4.21	4.21	4.21	
4.5	3.33	3.33	3.33		3.33	3.33	3.33	
5.0	2.70	2.70	2.70		2.70	2.70	2.70	
5.5	2.23	2.23	2.23		2.23	2.23	2.23	
6.0	1.87	1.87	1.87		1.87	1.87	1.87	
6.5	1.60	1.60	1.60		1.60	1.60	1.60	
7.0	1.38	1.38	1.38		1.38	1.38	1.38	
7.5	1.20	1.20	1.20		1.20	1.20	1.20	
8.0	1.05	1.05	1.05		1.02	1.05	1.05	
8.5	0.93	0.93	0.93		0.87	0.93	0.93	
9.0	0.83	0.83	0.83		0.75	0.83	0.83	
9.5	0.75	0.75	0.75		0.64	0.75	0.75	
10.0	0.67	0.67	0.67		0.53	0.67	0.67	
10.5	0.61	0.61	0.61		0.44	0.61	0.61	
11.0	0.56	0.56	0.56		0.37	0.54	0.56	
11.5								
12.0								
12.5								
13.0								
13.5								
14.0								
14.5								
15.0								
15.5								
16.0								
16.5								
17.0								
17.5								
18.0								

- 1B = One mid span brace
- 2B = Two equally spaced braces within the span
- 3B = Three equally spaced braces within the span
- w_s = Uniformly distributed serviceability load (kN/m) for deflection limit of Span/150
- $\phi_b w_u$ = Strength load resistance applied at the centroid (kN/m)

- 2-M12 Grade 4.6 bolts per connection
- 2-M12 Grade 8.8 bolts per connection
- 2-M16 Grade 4.6 bolts per connection
- 2-M16 Grade 8.8 bolts per connection

IMPORTANT

The adequacy of multispans system is very sensitive to actual applied loads. The stated loads in this table are assumed uniform over the full purlin system. Variations in actual project design loadings over the length of the purlin system must be checked specifically by the designer to verify system adequacy.

MULTISPAN CONTINUOUS (END SPAN)

LOAD TABLE – Uniformly Distributed Load

MSS 150/18									
SPAN (m)	INWARDS			Ws kN/m	OUTWARDS			Ws kN/m	
	$\phi_b w_u$ kN/m				$\phi_b w_u$ kN/m				
	1B	2B	3B		1B	2B	3B		
3.0	8.95	8.95	8.95	Generally not limiting design - verify by calculation	8.95	8.95	8.95	Generally not limiting design - verify by calculation	
3.5	6.58	6.58	6.58		6.58	6.58	6.58		
4.0	5.03	5.03	5.03		5.03	5.03	5.03		
4.5	3.98	3.98	3.98		3.98	3.98	3.98		
5.0	3.22	3.22	3.22		3.22	3.22	3.22		
5.5	2.66	2.66	2.66		2.66	2.66	2.66		
6.0	2.24	2.24	2.24		2.24	2.24	2.24		
6.5	1.91	1.91	1.91		1.91	1.91	1.91		
7.0	1.64	1.64	1.64		1.64	1.64	1.64		
7.5	1.43	1.43	1.43		1.41	1.43	1.43		
8.0	1.26	1.26	1.26		1.21	1.26	1.26		
8.5	1.12	1.12	1.12		1.04	1.12	1.12		
9.0	0.99	0.99	0.99		0.89	0.99	0.99		
9.5	0.89	0.89	0.89		0.77	0.89	0.89		
10.0	0.81	0.81	0.81		0.64	0.81	0.81		
10.5	0.73	0.73	0.73		0.53	0.72	0.73		
11.0	0.66	0.67	0.67		0.45	0.64	0.67		
11.5									
12.0									
12.5									
13.0									
13.5									
14.0									
14.5									
15.0									
15.5									
16.0									
16.5									
17.0									
17.5									
18.0									

MSS 150/23									
SPAN (m)	INWARDS			Ws kN/m	OUTWARDS			Ws kN/m	
	$\phi_b w_u$ kN/m				$\phi_b w_u$ kN/m				
	1B	2B	3B		1B	2B	3B		
3.0	12.3	12.3	12.3	Generally not limiting design - verify by calculation	12.3	12.3	12.3	Generally not limiting design - verify by calculation	
3.5	9.06	9.06	9.06		9.06	9.06	9.06		
4.0	6.93	6.93	6.93		6.93	6.93	6.93		
4.5	5.48	5.48	5.48		5.48	5.48	5.48		
5.0	4.44	4.44	4.44		4.44	4.44	4.44		
5.5	3.67	3.67	3.67		3.67	3.67	3.67		
6.0	3.08	3.08	3.08		3.07	3.08	3.08		
6.5	2.63	2.63	2.63		2.56	2.63	2.63		
7.0	2.26	2.26	2.26		2.15	2.26	2.26		
7.5	1.95	1.97	1.97		1.82	1.97	1.97		
8.0	1.70	1.73	1.73		1.55	1.73	1.73		
8.5	1.49	1.54	1.54		1.33	1.52	1.54		
9.0	1.31	1.37	1.37		1.14	1.34	1.37		
9.5	1.16	1.23	1.23		0.99	1.18	1.23		
10.0	1.04	1.11	1.11		0.83	1.04	1.11		
10.5	0.93	1.01	1.01		0.70	0.92	1.00		
11.0	0.83	0.91	0.92		0.59	0.82	0.90		
11.5									
12.0									
12.5									
13.0									
13.5									
14.0									
14.5									
15.0									
15.5									
16.0									
16.5									
17.0									
17.5									
18.0									

- 1B = One mid span brace
- 2B = Two equally spaced braces within the span
- 3B = Three equally spaced braces within the span
- w_s = Uniformly distributed serviceability load (kN/m) for deflection limit of Span/150
- $\phi_b w_u$ = Strength load resistance applied at the centroid (kN/m)

- 2-M12 Grade 4.6 bolts per connection
- 2-M12 Grade 8.8 bolts per connection
- 2-M16 Grade 4.6 bolts per connection
- 2-M16 Grade 8.8 bolts per connection

IMPORTANT

The adequacy of multispans system is very sensitive to actual applied loads. The stated loads in this table are assumed uniform over the full purlin system. Variations in actual project design loadings over the length of the purlin system must be checked specifically by the designer to verify system adequacy.

MULTISPAN CONTINUOUS (END SPAN)

LOAD TABLE – Uniformly Distributed Load

MSS 200/12								
SPAN (m)	INWARDS			Ws kN/m	OUTWARDS			Ws kN/m
	$\phi_b w_u$ kN/m				$\phi_b w_u$ kN/m			
	1B	2B	3B		1B	2B	3B	
3.0	7.10	7.10	7.10	Generally not limiting design - verify by calculation	7.10	7.10	7.10	Generally not limiting design - verify by calculation
3.5	5.47	5.47	5.47		5.47	5.47	5.47	
4.0	4.33	4.34	4.33		4.33	4.34	4.33	
4.5	3.46	3.46	3.46		3.46	3.46	3.46	
5.0	2.80	2.80	2.80		2.80	2.80	2.80	
5.5	2.31	2.31	2.31		2.31	2.31	2.31	
6.0	1.94	1.94	1.94		1.94	1.94	1.94	
6.5	1.66	1.66	1.66		1.66	1.66	1.66	
7.0	1.43	1.43	1.43		1.43	1.43	1.43	
7.5	1.24	1.24	1.24		1.24	1.24	1.24	
8.0	1.09	1.09	1.09		1.08	1.09	1.09	
8.5	0.97	0.97	0.97		0.93	0.97	0.97	
9.0	0.86	0.86	0.86		0.81	0.86	0.86	
9.5	0.78	0.78	0.78		0.71	0.78	0.78	
10.0	0.70	0.70	0.70		0.62	0.70	0.70	
10.5	0.63	0.63	0.63		0.55	0.63	0.63	
11.0	0.58	0.58	0.58		0.48	0.57	0.58	
11.5	0.53	0.53	0.53		0.42	0.51	0.53	
12.0	0.48	0.49	0.49	0.36	0.46	0.49		
12.5	0.44	0.45	0.45	0.31	0.42	0.45		
13.0	0.40	0.41	0.41	0.27	0.38	0.41		
13.5	0.37	0.38	0.38	0.24	0.35	0.38		
14.0	0.34	0.36	0.36	0.21	0.31	0.35		
14.5	0.31	0.33	0.33	0.18	0.29	0.32		
15.0	0.29	0.31	0.31	0.16	0.26	0.30		
15.5								
16.0								
16.5								
17.0								
17.5								
18.0								

MSS 200/15								
SPAN (m)	INWARDS			Ws kN/m	OUTWARDS			Ws kN/m
	$\phi_b w_u$ kN/m				$\phi_b w_u$ kN/m			
	1B	2B	3B		1B	2B	3B	
3.0	10.7	10.7	10.7	Generally not limiting design - verify by calculation	10.7	10.7	10.7	Generally not limiting design - verify by calculation
3.5	7.88	7.88	7.88		7.88	7.88	7.88	
4.0	6.03	6.03	6.03		6.03	6.03	6.03	
4.5	4.77	4.76	4.76		4.77	4.76	4.76	
5.0	3.86	3.86	3.86		3.86	3.86	3.86	
5.5	3.19	3.19	3.19		3.19	3.19	3.19	
6.0	2.68	2.68	2.68		2.68	2.68	2.68	
6.5	2.28	2.28	2.28		2.28	2.28	2.28	
7.0	1.97	1.97	1.97		1.97	1.97	1.97	
7.5	1.72	1.72	1.72		1.72	1.72	1.72	
8.0	1.51	1.51	1.51		1.51	1.51	1.51	
8.5	1.34	1.34	1.34		1.34	1.34	1.34	
9.0	1.19	1.19	1.19		1.19	1.19	1.19	
9.5	1.07	1.07	1.07		1.05	1.07	1.07	
10.0	0.96	0.96	0.96		0.92	0.96	0.96	
10.5	0.88	0.88	0.88		0.79	0.88	0.88	
11.0	0.80	0.80	0.80		0.67	0.80	0.80	
11.5	0.73	0.73	0.73		0.57	0.73	0.73	
12.0	0.67	0.67	0.67	0.49	0.67	0.67		
12.5	0.62	0.62	0.62	0.42	0.62	0.62		
13.0	0.57	0.57	0.57	0.36	0.56	0.57		
13.5	0.53	0.53	0.53	0.31	0.51	0.53		
14.0	0.49	0.49	0.49	0.27	0.46	0.49		
14.5	0.45	0.46	0.46	0.24	0.42	0.46		
15.0	0.42	0.43	0.43	0.21	0.37	0.43		
15.5								
16.0								
16.5								
17.0								
17.5								
18.0								

- 1B = One mid span brace
- 2B = Two equally spaced braces within the span
- 3B = Three equally spaced braces within the span
- w_s = Uniformly distributed serviceability load (kN/m) for deflection limit of Span/150
- $\phi_b w_u$ = Strength load resistance applied at the centroid (kN/m)

- 2-M12 Grade 4.6 bolts per connection
- 2-M12 Grade 8.8 bolts per connection
- 2-M16 Grade 4.6 bolts per connection
- 2-M16 Grade 8.8 bolts per connection

IMPORTANT

The adequacy of multispan system is very sensitive to actual applied loads. The stated loads in this table are assumed uniform over the full purlin system. Variations in actual project design loadings over the length of the purlin system must be checked specifically by the designer to verify system adequacy.

MULTISPAN CONTINUOUS (END SPAN)

LOAD TABLE – Uniformly Distributed Load

MSS 200/18									
SPAN (m)	INWARDS			Ws kN/m	OUTWARDS			Ws kN/m	
	$\phi_b w_u$ kN/m				$\phi_b w_u$ kN/m				
	1B	2B	3B		1B	2B	3B		
3.0	12.9	12.9	12.9	Generally not limiting design - verify by calculation	12.9	12.9	12.9	Generally not limiting design - verify by calculation	
3.5	9.51	9.51	9.51		9.51	9.51	9.51		
4.0	7.28	7.28	7.28		7.28	7.28	7.28		
4.5	5.75	5.75	5.75		5.75	5.75	5.75		
5.0	4.66	4.66	4.66		4.66	4.66	4.66		
5.5	3.85	3.85	3.85		3.85	3.85	3.85		
6.0	3.24	3.24	3.24		3.24	3.24	3.24		
6.5	2.76	2.76	2.76		2.76	2.76	2.76		
7.0	2.38	2.38	2.38		2.38	2.38	2.38		
7.5	2.07	2.07	2.07		2.07	2.07	2.07		
8.0	1.82	1.82	1.82		1.82	1.82	1.82		
8.5	1.61	1.61	1.61		1.61	1.61	1.61		
9.0	1.44	1.44	1.44		1.44	1.44	1.44		
9.5	1.29	1.29	1.29		1.29	1.29	1.29		
10.0	1.17	1.17	1.17		1.17	1.17	1.17		
10.5	1.06	1.06	1.06		1.06	1.06	1.06		
11.0	0.96	0.96	0.96		0.96	0.96	0.96		
11.5	0.88	0.88	0.88		0.88	0.88	0.88		
12.0	0.81	0.81	0.81	0.81	0.81	0.81			
12.5	0.75	0.75	0.75	0.75	0.75	0.75			
13.0	0.69	0.69	0.69	0.69	0.69	0.69			
13.5	0.64	0.64	0.64	0.64	0.64	0.64			
14.0	0.59	0.59	0.59	0.59	0.59	0.59			
14.5	0.54	0.55	0.55	0.54	0.55	0.55			
15.0	0.50	0.52	0.52	0.50	0.52	0.52			
15.5									
16.0									
16.5									
17.0									
17.5									
18.0									

MSS 200/23									
SPAN (m)	INWARDS			Ws kN/m	OUTWARDS			Ws kN/m	
	$\phi_b w_u$ kN/m				$\phi_b w_u$ kN/m				
	1B	2B	3B		1B	2B	3B		
3.0	16.6	16.6	16.6	Generally not limiting design - verify by calculation	16.6	16.6	16.6	Generally not limiting design - verify by calculation	
3.5	13.3	13.3	13.3		13.3	13.3	13.3		
4.0	10.2	10.2	10.2		10.2	10.2	10.2		
4.5	8.03	8.03	8.03		8.03	8.03	8.03		
5.0	6.51	6.51	6.51		6.51	6.51	6.51		
5.5	5.38	5.38	5.38		5.38	5.38	5.38		
6.0	4.52	4.52	4.52		4.52	4.52	4.52		
6.5	3.85	3.85	3.85		3.85	3.85	3.85		
7.0	3.32	3.32	3.32		3.32	3.32	3.32		
7.5	2.89	2.89	2.89		2.89	2.89	2.89		
8.0	2.54	2.54	2.54		2.54	2.54	2.54		
8.5	2.25	2.25	2.25		2.25	2.25	2.25		
9.0	2.01	2.01	2.01		2.01	2.01	2.01		
9.5	1.80	1.80	1.80		1.80	1.80	1.80		
10.0	1.61	1.63	1.63		1.61	1.63	1.63		
10.5	1.45	1.48	1.48		1.45	1.48	1.48		
11.0	1.31	1.34	1.34		1.31	1.34	1.34		
11.5	1.19	1.23	1.23		1.19	1.23	1.23		
12.0	1.08	1.13	1.13	1.08	1.13	1.13			
12.5	0.99	1.04	1.04	0.99	1.04	1.04			
13.0	0.91	0.96	0.96	0.91	0.96	0.96			
13.5	0.83	0.89	0.89	0.83	0.89	0.89			
14.0	0.77	0.83	0.83	0.77	0.83	0.83			
14.5	0.70	0.77	0.77	0.70	0.77	0.77			
15.0	0.65	0.71	0.72	0.65	0.71	0.72			
15.5									
16.0									
16.5									
17.0									
17.5									
18.0									

- 1B = One mid span brace
- 2B = Two equally spaced braces within the span
- 3B = Three equally spaced braces within the span
- w_s = Uniformly distributed serviceability load (kN/m) for deflection limit of Span/150
- $\phi_b w_u$ = Strength load resistance applied at the centroid (kN/m)

- 2-M12 Grade 4.6 bolts per connection
- 2-M12 Grade 8.8 bolts per connection
- 2-M16 Grade 4.6 bolts per connection
- 2-M16 Grade 8.8 bolts per connection

IMPORTANT

The adequacy of multispans system is very sensitive to actual applied loads. The stated loads in this table are assumed uniform over the full purlin system. Variations in actual project design loadings over the length of the purlin system must be checked specifically by the designer to verify system adequacy.

MULTISPAN CONTINUOUS (END SPAN)

LOAD TABLE – Uniformly Distributed Load

MSS 250/13								
SPAN (m)	INWARDS			Ws kN/m	OUTWARDS			Ws kN/m
	$\phi_b w_u$ kN/m				$\phi_b w_u$ kN/m			
	1B	2B	3B		1B	2B	3B	
3.0								
3.5								
4.0	6.11	6.11	6.11		6.11	6.11	6.11	
4.5	5.00	5.00	5.00		5.00	5.00	5.00	
5.0	4.15	4.15	4.15		4.15	4.15	4.15	
5.5	3.50	3.50	3.50		3.50	3.50	3.50	
6.0	2.99	2.99	2.99		2.99	2.99	2.99	
6.5	2.58	2.58	2.58		2.58	2.58	2.58	
7.0	2.24	2.24	2.24		2.24	2.24	2.24	
7.5	1.95	1.95	1.95		1.93	1.95	1.95	
8.0	1.71	1.71	1.71		1.67	1.71	1.71	
8.5	1.52	1.52	1.52		1.46	1.52	1.52	
9.0	1.35	1.35	1.35		1.28	1.35	1.35	
9.5	1.20	1.22	1.22		1.13	1.22	1.22	
10.0	1.08	1.10	1.10		1.00	1.10	1.10	
10.5	0.97	0.99	0.99		0.88	0.98	0.99	
11.0	0.88	0.91	0.91		0.79	0.89	0.91	
11.5	0.80	0.83	0.83		0.70	0.80	0.83	
12.0	0.73	0.76	0.76		0.63	0.73	0.76	
12.5	0.66	0.70	0.70		0.56	0.66	0.70	
13.0	0.61	0.65	0.65		0.50	0.60	0.64	
13.5	0.56	0.60	0.60		0.44	0.55	0.59	
14.0	0.52	0.55	0.56		0.40	0.51	0.55	
14.5	0.48	0.51	0.52		0.35	0.46	0.50	
15.0	0.44	0.47	0.49		0.32	0.43	0.47	
15.5	0.41	0.44	0.46		0.28	0.39	0.43	
16.0	0.38	0.41	0.43		0.25	0.36	0.40	
16.5	0.35	0.38	0.40		0.23	0.33	0.37	
17.0	0.33	0.36	0.38		0.20	0.31	0.35	
17.5								
18.0								

Generally not limiting design - verify by calculation

Generally not limiting design - verify by calculation

MSS 250/15								
SPAN (m)	INWARDS			Ws kN/m	OUTWARDS			Ws kN/m
	$\phi_b w_u$ kN/m				$\phi_b w_u$ kN/m			
	1B	2B	3B		1B	2B	3B	
3.0								
3.5								
4.0	7.98	7.98	7.98		7.98	7.98	7.98	
4.5	6.49	6.49	6.49		6.49	6.49	6.49	
5.0	5.37	5.37	5.37		5.37	5.37	5.37	
5.5	4.45	4.45	4.45		4.45	4.45	4.45	
6.0	3.74	3.74	3.74		3.74	3.74	3.74	
6.5	3.19	3.19	3.19		3.19	3.19	3.19	
7.0	2.75	2.75	2.75		2.75	2.75	2.75	
7.5	2.40	2.40	2.40		2.40	2.40	2.40	
8.0	2.11	2.11	2.11		2.11	2.11	2.11	
8.5	1.87	1.87	1.87		1.84	1.87	1.87	
9.0	1.66	1.66	1.66		1.61	1.66	1.66	
9.5	1.49	1.49	1.49		1.42	1.49	1.49	
10.0	1.35	1.35	1.35		1.26	1.35	1.35	
10.5	1.21	1.22	1.22		1.12	1.22	1.22	
11.0	1.10	1.11	1.11		0.99	1.11	1.11	
11.5	1.00	1.02	1.02		0.89	1.01	1.02	
12.0	0.91	0.94	0.94		0.79	0.92	0.94	
12.5	0.83	0.86	0.86		0.71	0.84	0.86	
13.0	0.76	0.80	0.80		0.64	0.76	0.80	
13.5	0.70	0.74	0.74		0.56	0.70	0.74	
14.0	0.64	0.69	0.69		0.49	0.64	0.69	
14.5	0.60	0.64	0.64		0.44	0.59	0.64	
15.0	0.55	0.60	0.60		0.38	0.54	0.59	
15.5	0.51	0.55	0.56		0.34	0.50	0.55	
16.0	0.47	0.52	0.53		0.30	0.46	0.51	
16.5	0.44	0.48	0.49		0.27	0.42	0.47	
17.0	0.41	0.45	0.47		0.24	0.39	0.44	
17.5								
18.0								

Generally not limiting design - verify by calculation

Generally not limiting design - verify by calculation

- 1B = One mid span brace
- 2B = Two equally spaced braces within the span
- 3B = Three equally spaced braces within the span
- w_s = Uniformly distributed serviceability load (kN/m) for deflection limit of Span/150
- $\phi_b w_u$ = Strength load resistance applied at the centroid (kN/m)

- 2-M12 Grade 4.6 bolts per connection
- 2-M12 Grade 8.8 bolts per connection
- 2-M16 Grade 4.6 bolts per connection
- 2-M16 Grade 8.8 bolts per connection

IMPORTANT

The adequacy of multispans system is very sensitive to actual applied loads. The stated loads in this table are assumed uniform over the full purlin system. Variations in actual project design loadings over the length of the purlin system must be checked specifically by the designer to verify system adequacy.

MULTISPAN CONTINUOUS (END SPAN)

LOAD TABLE – Uniformly Distributed Load

MSS 250/18								
SPAN (m)	INWARDS			Ws kN/m	OUTWARDS			Ws kN/m
	$\phi_b w_u$ kN/m				$\phi_b w_u$ kN/m			
	1B	2B	3B		1B	2B	3B	
3.0								
3.5								
4.0	9.68	9.68	9.68		9.68	9.68	9.68	
4.5	8.08	8.08	8.08		8.08	8.08	8.08	
5.0	6.54	6.54	6.54		6.54	6.54	6.54	
5.5	5.41	5.41	5.41		5.41	5.41	5.41	
6.0	4.54	4.54	4.54		4.54	4.54	4.54	
6.5	3.87	3.87	3.87		3.87	3.87	3.87	
7.0	3.34	3.34	3.34		3.34	3.34	3.34	
7.5	2.91	2.91	2.91		2.91	2.91	2.91	
8.0	2.56	2.56	2.56		2.56	2.56	2.56	
8.5	2.26	2.26	2.26		2.26	2.26	2.26	
9.0	2.02	2.02	2.02		2.02	2.02	2.02	
9.5	1.81	1.81	1.81		1.81	1.81	1.81	
10.0	1.64	1.64	1.64		1.63	1.64	1.64	
10.5	1.48	1.48	1.48		1.46	1.48	1.48	
11.0	1.35	1.35	1.35		1.30	1.35	1.35	
11.5	1.24	1.24	1.24		1.17	1.24	1.24	
12.0	1.14	1.14	1.14		1.05	1.14	1.14	
12.5	1.05	1.05	1.05		0.94	1.05	1.05	
13.0	0.97	0.97	0.97		0.82	0.97	0.97	
13.5	0.90	0.90	0.90		0.71	0.90	0.90	
14.0	0.83	0.83	0.83		0.62	0.83	0.83	
14.5	0.77	0.78	0.78		0.55	0.76	0.78	
15.0	0.71	0.73	0.73		0.48	0.70	0.73	
15.5	0.66	0.68	0.68		0.42	0.65	0.68	
16.0	0.61	0.64	0.64		0.38	0.60	0.64	
16.5	0.57	0.60	0.60		0.33	0.56	0.60	
17.0	0.53	0.57	0.57		0.30	0.52	0.57	
17.5								
18.0								

Generally not limiting design - verify by calculation

Generally not limiting design - verify by calculation

MSS 250/23								
SPAN (m)	INWARDS			Ws kN/m	OUTWARDS			Ws kN/m
	$\phi_b w_u$ kN/m				$\phi_b w_u$ kN/m			
	1B	2B	3B		1B	2B	3B	
3.0								
3.5								
4.0	12.4	12.4	12.4		12.4	12.4	12.4	
4.5	11.1	11.1	11.1		11.1	11.1	11.1	
5.0	9.17	9.17	9.17		9.17	9.17	9.17	
5.5	7.58	7.58	7.58		7.58	7.58	7.58	
6.0	6.37	6.37	6.37		6.37	6.37	6.37	
6.5	5.43	5.43	5.43		5.43	5.43	5.43	
7.0	4.68	4.68	4.68		4.68	4.68	4.68	
7.5	4.08	4.08	4.08		4.08	4.08	4.08	
8.0	3.58	3.58	3.58		3.58	3.58	3.58	
8.5	3.17	3.17	3.17		3.17	3.17	3.17	
9.0	2.83	2.83	2.83		2.83	2.83	2.83	
9.5	2.54	2.54	2.54		2.54	2.54	2.54	
10.0	2.29	2.29	2.29		2.29	2.29	2.29	
10.5	2.08	2.08	2.08		2.06	2.08	2.08	
11.0	1.90	1.90	1.90		1.83	1.90	1.90	
11.5	1.73	1.73	1.73		1.63	1.73	1.73	
12.0	1.59	1.59	1.59		1.45	1.59	1.59	
12.5	1.47	1.47	1.47		1.25	1.47	1.47	
13.0	1.36	1.36	1.36		1.08	1.36	1.36	
13.5	1.25	1.26	1.26		0.93	1.26	1.26	
14.0	1.15	1.17	1.17		0.81	1.17	1.17	
14.5	1.06	1.09	1.09		0.71	1.09	1.09	
15.0	0.98	1.02	1.02		0.62	0.99	1.02	
15.5	0.91	0.95	0.95		0.55	0.91	0.95	
16.0	0.84	0.90	0.90		0.49	0.84	0.90	
16.5	0.78	0.84	0.84		0.43	0.77	0.84	
17.0	0.72	0.79	0.79		0.39	0.70	0.79	
17.5								
18.0								

Generally not limiting design - verify by calculation

Generally not limiting design - verify by calculation

- 1B = One mid span brace
- 2B = Two equally spaced braces within the span
- 3B = Three equally spaced braces within the span
- w_s = Uniformly distributed serviceability load (kN/m) for deflection limit of Span/150
- $\phi_b w_u$ = Strength load resistance applied at the centroid (kN/m)

- 2-M12 Grade 4.6 bolts per connection
- 2-M12 Grade 8.8 bolts per connection
- 2-M16 Grade 4.6 bolts per connection
- 2-M16 Grade 8.8 bolts per connection

IMPORTANT

The adequacy of multispan system is very sensitive to actual applied loads. The stated loads in this table are assumed uniform over the full purlin system. Variations in actual project design loadings over the length of the purlin system must be checked specifically by the designer to verify system adequacy.

MULTISPAN CONTINUOUS (END SPAN)

LOAD TABLE – Uniformly Distributed Load

MSS 275/15								
SPAN (m)	INWARDS			Ws kN/m	OUTWARDS			Ws kN/m
	$\phi_b w_u$ kN/m				$\phi_b w_u$ kN/m			
	1B	2B	3B		1B	2B	3B	
3.0								
3.5								
4.0								
4.5	6.60	6.60	6.60		6.60	6.60	6.60	
5.0	5.54	5.54	5.54		5.54	5.54	5.54	
5.5	4.70	4.70	4.70		4.70	4.70	4.70	
6.0	4.04	4.04	4.04		4.04	4.04	4.04	
6.5	3.51	3.51	3.51		3.51	3.51	3.51	
7.0	3.07	3.07	3.07		3.07	3.07	3.07	
7.5	2.68	2.68	2.68		2.68	2.68	2.68	
8.0	2.36	2.36	2.36		2.36	2.36	2.36	
8.5	2.09	2.09	2.09		2.07	2.09	2.09	
9.0	1.86	1.86	1.86		1.82	1.86	1.86	
9.5	1.67	1.67	1.67		1.61	1.67	1.67	
10.0	1.50	1.51	1.51		1.42	1.51	1.51	
10.5	1.35	1.37	1.37		1.27	1.37	1.37	
11.0	1.23	1.25	1.25		1.13	1.25	1.25	
11.5	1.11	1.14	1.14		1.01	1.14	1.14	
12.0	1.02	1.05	1.05		0.90	1.04	1.05	
12.5	0.93	0.97	0.97		0.81	0.94	0.97	
13.0	0.85	0.89	0.89		0.73	0.86	0.89	
13.5	0.78	0.83	0.83		0.66	0.79	0.83	
14.0	0.72	0.77	0.77		0.59	0.72	0.77	
14.5	0.67	0.72	0.72		0.52	0.66	0.72	
15.0	0.62	0.67	0.67		0.47	0.61	0.66	
15.5	0.57	0.62	0.63		0.42	0.56	0.62	
16.0	0.53	0.58	0.59		0.37	0.52	0.57	
16.5	0.50	0.54	0.55		0.33	0.48	0.53	
17.0	0.46	0.50	0.52		0.30	0.44	0.50	
17.5								
18.0								

Generally not limiting design - verify by calculation

Generally not limiting design - verify by calculation

MSS 275/18								
SPAN (m)	INWARDS			Ws kN/m	OUTWARDS			Ws kN/m
	$\phi_b w_u$ kN/m				$\phi_b w_u$ kN/m			
	1B	2B	3B		1B	2B	3B	
3.0								
3.5								
4.0								
4.5	8.60	8.60	8.60		8.60	8.60	8.60	
5.0	7.34	7.34	7.34		7.34	7.34	7.34	
5.5	6.06	6.06	6.06		6.06	6.06	6.06	
6.0	5.09	5.09	5.09		5.09	5.09	5.09	
6.5	4.34	4.34	4.34		4.34	4.34	4.34	
7.0	3.74	3.74	3.74		3.74	3.74	3.74	
7.5	3.26	3.26	3.26		3.26	3.26	3.26	
8.0	2.87	2.87	2.87		2.87	2.87	2.87	
8.5	2.54	2.54	2.54		2.54	2.54	2.54	
9.0	2.26	2.26	2.26		2.26	2.26	2.26	
9.5	2.03	2.03	2.03		2.03	2.03	2.03	
10.0	1.83	1.83	1.83		1.83	1.83	1.83	
10.5	1.66	1.66	1.66		1.64	1.66	1.66	
11.0	1.52	1.52	1.52		1.47	1.52	1.52	
11.5	1.39	1.39	1.39		1.32	1.39	1.39	
12.0	1.27	1.27	1.27		1.19	1.27	1.27	
12.5	1.17	1.17	1.17		1.07	1.17	1.17	
13.0	1.09	1.09	1.09		0.97	1.09	1.09	
13.5	1.00	1.01	1.01		0.87	1.01	1.01	
14.0	0.92	0.94	0.94		0.77	0.94	0.94	
14.5	0.85	0.87	0.87		0.67	0.86	0.87	
15.0	0.79	0.82	0.82		0.60	0.80	0.82	
15.5	0.74	0.76	0.76		0.53	0.74	0.76	
16.0	0.68	0.72	0.72		0.47	0.68	0.72	
16.5	0.64	0.67	0.67		0.42	0.63	0.67	
17.0	0.60	0.63	0.63		0.37	0.58	0.63	
17.5								
18.0								

Generally not limiting design - verify by calculation

Generally not limiting design - verify by calculation

- 1B = One mid span brace
- 2B = Two equally spaced braces within the span
- 3B = Three equally spaced braces within the span
- w_s = Uniformly distributed serviceability load (kN/m) for deflection limit of Span/150
- $\phi_b w_u$ = Strength load resistance applied at the centroid (kN/m)

- 2-M12 Grade 4.6 bolts per connection
- 2-M12 Grade 8.8 bolts per connection
- 2-M16 Grade 4.6 bolts per connection
- 2-M16 Grade 8.8 bolts per connection

IMPORTANT

The adequacy of multispans system is very sensitive to actual applied loads. The stated loads in this table are assumed uniform over the full purlin system. Variations in actual project design loadings over the length of the purlin system must be checked specifically by the designer to verify system adequacy.

MULTISPAN CONTINUOUS (END SPAN)

LOAD TABLE – Uniformly Distributed Load

MSS 300/15								
SPAN (m)	INWARDS			Ws kN/m	OUTWARDS			Ws kN/m
	$\phi_b w_u$ kN/m				$\phi_b w_u$ kN/m			
	1B	2B	3B		1B	2B	3B	
3.0								
3.5								
4.0								
4.5								
5.0	5.76	5.76	5.76		5.76	5.76	5.76	
5.5	4.95	4.95	4.95		4.95	4.95	4.95	
6.0	4.28	4.28	4.28		4.28	4.28	4.28	
6.5	3.74	3.74	3.74		3.74	3.74	3.74	
7.0	3.30	3.30	3.30		3.30	3.30	3.30	
7.5	2.92	2.92	2.92		2.92	2.92	2.92	
8.0	2.61	2.61	2.61		2.61	2.61	2.61	
8.5	2.34	2.34	2.34		2.34	2.34	2.34	
9.0	2.11	2.11	2.11		2.11	2.11	2.11	
9.5	1.91	1.91	1.91		1.91	1.91	1.91	
10.0	1.74	1.74	1.74		1.70	1.74	1.74	
10.5	1.57	1.58	1.58		1.52	1.58	1.58	
11.0	1.43	1.44	1.44		1.36	1.44	1.44	
11.5	1.30	1.32	1.32		1.22	1.32	1.32	
12.0	1.18	1.21	1.21		1.10	1.21	1.21	
12.5	1.08	1.12	1.12		1.00	1.11	1.12	
13.0	0.99	1.03	1.03		0.90	1.02	1.03	
13.5	0.91	0.96	0.96		0.82	0.94	0.96	
14.0	0.84	0.89	0.89		0.74	0.87	0.89	
14.5	0.78	0.83	0.83		0.67	0.80	0.83	
15.0	0.72	0.77	0.77		0.61	0.74	0.77	
15.5	0.67	0.73	0.73		0.55	0.68	0.73	
16.0	0.63	0.68	0.68		0.49	0.63	0.68	
16.5	0.58	0.64	0.64		0.44	0.59	0.63	
17.0	0.55	0.60	0.60		0.40	0.54	0.59	
17.5	0.51	0.56	0.57		0.36	0.51	0.55	
18.0	0.48	0.52	0.54		0.33	0.47	0.52	

Generally not limiting design - verify by calculation

Generally not limiting design - verify by calculation

MSS 300/18								
SPAN (m)	INWARDS			Ws kN/m	OUTWARDS			Ws kN/m
	$\phi_b w_u$ kN/m				$\phi_b w_u$ kN/m			
	1B	2B	3B		1B	2B	3B	
3.0								
3.5								
4.0								
4.5								
5.0	7.74	7.74	7.74		7.74	7.74	7.74	
5.5	6.77	6.77	6.77		6.77	6.77	6.77	
6.0	5.83	5.83	5.83		5.83	5.83	5.83	
6.5	5.03	5.03	5.03		5.03	5.03	5.03	
7.0	4.34	4.34	4.34		4.34	4.34	4.34	
7.5	3.78	3.78	3.78		3.78	3.78	3.78	
8.0	3.32	3.32	3.32		3.32	3.32	3.32	
8.5	2.94	2.94	2.94		2.94	2.94	2.94	
9.0	2.62	2.62	2.62		2.62	2.62	2.62	
9.5	2.35	2.35	2.35		2.35	2.35	2.35	
10.0	2.12	2.12	2.12		2.12	2.12	2.12	
10.5	1.93	1.93	1.93		1.93	1.93	1.93	
11.0	1.76	1.76	1.76		1.75	1.76	1.76	
11.5	1.61	1.61	1.61		1.58	1.61	1.61	
12.0	1.48	1.48	1.48		1.43	1.48	1.48	
12.5	1.36	1.36	1.36		1.29	1.36	1.36	
13.0	1.26	1.26	1.26		1.17	1.26	1.26	
13.5	1.16	1.17	1.17		1.07	1.17	1.17	
14.0	1.07	1.08	1.08		0.97	1.08	1.08	
14.5	0.99	1.01	1.01		0.89	1.01	1.01	
15.0	0.92	0.94	0.94		0.81	0.94	0.94	
15.5	0.86	0.88	0.88		0.74	0.88	0.88	
16.0	0.80	0.83	0.83		0.66	0.81	0.83	
16.5	0.75	0.78	0.78		0.59	0.76	0.78	
17.0	0.70	0.74	0.74		0.52	0.70	0.74	
17.5	0.65	0.69	0.69		0.47	0.66	0.69	
18.0	0.61	0.66	0.66		0.42	0.61	0.66	

Generally not limiting design - verify by calculation

Generally not limiting design - verify by calculation

- 1B = One mid span brace
- 2B = Two equally spaced braces within the span
- 3B = Three equally spaced braces within the span
- w_s = Uniformly distributed serviceability load (kN/m) for deflection limit of Span/150
- $\phi_b w_u$ = Strength load resistance applied at the centroid (kN/m)

- 2-M12 Grade 4.6 bolts per connection
- 2-M12 Grade 8.8 bolts per connection
- 2-M16 Grade 4.6 bolts per connection
- 2-M16 Grade 8.8 bolts per connection

IMPORTANT

The adequacy of multispans system is very sensitive to actual applied loads. The stated loads in this table are assumed uniform over the full purlin system. Variations in actual project design loadings over the length of the purlin system must be checked specifically by the designer to verify system adequacy.

MULTISPAN CONTINUOUS (END SPAN)

LOAD TABLE – Uniformly Distributed Load

MSS 300/23								
SPAN (m)	INWARDS			Ws kN/m	OUTWARDS			Ws kN/m
	$\phi_b w_u$ kN/m				$\phi_b w_u$ kN/m			
	1B	2B	3B		1B	2B	3B	
3.0								
3.5								
4.0								
4.5								
5.0	9.95	9.95	9.95		9.95	9.95	9.95	
5.5	9.05	9.05	9.05		9.05	9.05	9.05	
6.0	8.29	8.30	8.29		8.29	8.30	8.29	
6.5	7.09	7.09	7.09		7.09	7.09	7.09	
7.0	6.12	6.12	6.12		6.12	6.12	6.12	
7.5	5.33	5.33	5.33		5.33	5.33	5.33	
8.0	4.68	4.68	4.68		4.68	4.68	4.68	
8.5	4.15	4.15	4.15		4.15	4.15	4.15	
9.0	3.70	3.70	3.70		3.70	3.70	3.70	
9.5	3.32	3.32	3.32		3.32	3.32	3.32	
10.0	3.00	3.00	3.00		3.00	3.00	3.00	
10.5	2.72	2.72	2.72		2.72	2.72	2.72	
11.0	2.48	2.48	2.48		2.48	2.48	2.48	
11.5	2.27	2.27	2.27		2.27	2.27	2.27	
12.0	2.08	2.08	2.08		2.08	2.08	2.08	
12.5	1.92	1.92	1.92		1.92	1.92	1.92	
13.0	1.77	1.77	1.77		1.75	1.77	1.77	
13.5	1.65	1.65	1.65		1.58	1.65	1.65	
14.0	1.53	1.53	1.53		1.43	1.53	1.53	
14.5	1.43	1.43	1.43		1.28	1.43	1.43	
15.0	1.33	1.33	1.33		1.13	1.33	1.33	
15.5	1.25	1.25	1.25		1.00	1.25	1.25	
16.0	1.17	1.17	1.17		0.89	1.17	1.17	
16.5	1.09	1.10	1.10		0.79	1.10	1.10	
17.0	1.01	1.04	1.04		0.70	1.04	1.04	
17.5	0.95	0.98	0.98		0.63	0.98	0.98	
18.0	0.88	0.93	0.93		0.56	0.91	0.93	

Generally not limiting design - verify by calculation

Generally not limiting design - verify by calculation

MSS 300/24								
SPAN (m)	INWARDS			Ws kN/m	OUTWARDS			Ws kN/m
	$\phi_b w_u$ kN/m				$\phi_b w_u$ kN/m			
	1B	2B	3B		1B	2B	3B	
3.0								
3.5								
4.0								
4.5								
5.0	10.6	10.6	10.6		10.6	10.6	10.6	
5.5	9.65	9.65	9.65		9.65	9.65	9.65	
6.0	8.85	8.85	8.85		8.85	8.85	8.85	
6.5	7.76	7.76	7.76		7.76	7.76	7.76	
7.0	6.69	6.69	6.69		6.69	6.69	6.69	
7.5	5.83	5.83	5.83		5.83	5.83	5.83	
8.0	5.12	5.12	5.12		5.12	5.12	5.12	
8.5	4.54	4.54	4.54		4.54	4.54	4.54	
9.0	4.05	4.05	4.05		4.05	4.05	4.05	
9.5	3.63	3.63	3.63		3.63	3.63	3.63	
10.0	3.28	3.28	3.28		3.28	3.28	3.28	
10.5	2.98	2.98	2.98		2.98	2.98	2.98	
11.0	2.71	2.71	2.71		2.71	2.71	2.71	
11.5	2.48	2.48	2.48		2.48	2.48	2.48	
12.0	2.28	2.28	2.28		2.28	2.28	2.28	
12.5	2.10	2.10	2.10		2.09	2.10	2.10	
13.0	1.94	1.94	1.94		1.89	1.94	1.94	
13.5	1.80	1.80	1.80		1.71	1.80	1.80	
14.0	1.67	1.67	1.67		1.55	1.67	1.67	
14.5	1.56	1.56	1.56		1.38	1.56	1.56	
15.0	1.46	1.46	1.46		1.21	1.46	1.46	
15.5	1.35	1.37	1.37		1.07	1.37	1.37	
16.0	1.25	1.28	1.28		0.94	1.28	1.28	
16.5	1.17	1.21	1.21		0.84	1.21	1.21	
17.0	1.09	1.14	1.14		0.75	1.14	1.14	
17.5	1.01	1.07	1.07		0.67	1.06	1.07	
18.0	0.95	1.01	1.01		0.60	0.99	1.01	

Generally not limiting design - verify by calculation

Generally not limiting design - verify by calculation

- 1B = One mid span brace
- 2B = Two equally spaced braces within the span
- 3B = Three equally spaced braces within the span
- w_s = Uniformly distributed serviceability load (kN/m) for deflection limit of Span/150
- $\phi_b w_u$ = Strength load resistance applied at the centroid (kN/m)

- 2-M12 Grade 4.6 bolts per connection
- 2-M12 Grade 8.8 bolts per connection
- 2-M16 Grade 4.6 bolts per connection
- 2-M16 Grade 8.8 bolts per connection

IMPORTANT

The adequacy of multispans system is very sensitive to actual applied loads. The stated loads in this table are assumed uniform over the full purlin system. Variations in actual project design loadings over the length of the purlin system must be checked specifically by the designer to verify system adequacy.

MULTISPAN CONTINUOUS (END SPAN)

LOAD TABLE – Uniformly Distributed Load

MSS 300/30								
SPAN (m)	INWARDS			Ws kN/m	OUTWARDS			Ws kN/m
	$\phi_b w_u$ kN/m				$\phi_b w_u$ kN/m			
	1B	2B	3B		1B	2B	3B	
3.0								
3.5								
4.0								
4.5								
5.0	13.1	13.1	13.1		13.1	13.1	13.1	
5.5	11.9	11.9	11.9		11.9	11.9	11.9	
6.0	10.9	10.9	10.9		10.9	10.9	10.9	
6.5	10.0	10.0	10.0		10.0	10.0	10.0	
7.0	8.80	8.80	8.80		8.80	8.80	8.80	
7.5	7.66	7.66	7.66		7.66	7.66	7.66	
8.0	6.74	6.74	6.74		6.74	6.74	6.74	
8.5	5.97	5.97	5.97		5.97	5.97	5.97	
9.0	5.32	5.32	5.32		5.32	5.32	5.32	
9.5	4.78	4.78	4.78		4.78	4.78	4.78	
10.0	4.31	4.31	4.31		4.31	4.31	4.31	
10.5	3.91	3.91	3.91		3.91	3.91	3.91	
11.0	3.56	3.56	3.56		3.56	3.56	3.56	
11.5	3.26	3.26	3.26		3.26	3.26	3.26	
12.0	2.99	2.99	2.99		2.97	2.99	2.99	
12.5	2.76	2.76	2.76		2.67	2.76	2.76	
13.0	2.53	2.55	2.55		2.40	2.55	2.55	
13.5	2.32	2.37	2.37		2.16	2.37	2.37	
14.0	2.13	2.20	2.20		1.93	2.20	2.20	
14.5	1.96	2.05	2.05		1.70	2.05	2.05	
15.0	1.81	1.92	1.92		1.49	1.92	1.92	
15.5	1.67	1.79	1.79		1.31	1.79	1.79	
16.0	1.55	1.68	1.68		1.16	1.68	1.68	
16.5	1.43	1.58	1.58		1.03	1.58	1.58	
17.0	1.33	1.49	1.49		0.92	1.46	1.49	
17.5	1.24	1.41	1.41		0.82	1.36	1.41	
18.0	1.16	1.33	1.33		0.74	1.26	1.33	

Generally not limiting design - verify by calculation

Generally not limiting design - verify by calculation

MSS 325/15								
SPAN (m)	INWARDS			Ws kN/m	OUTWARDS			Ws kN/m
	$\phi_b w_u$ kN/m				$\phi_b w_u$ kN/m			
	1B	2B	3B		1B	2B	3B	
3.0								
3.5								
4.0								
4.5								
5.0	5.98	5.98	5.98		5.98	5.98	5.98	
5.5	5.16	5.16	5.16		5.16	5.16	5.16	
6.0	4.49	4.49	4.49		4.49	4.49	4.49	
6.5	3.94	3.94	3.94		3.94	3.94	3.94	
7.0	3.48	3.48	3.48		3.48	3.48	3.48	
7.5	3.09	3.09	3.09		3.09	3.09	3.09	
8.0	2.77	2.77	2.77		2.77	2.77	2.77	
8.5	2.49	2.49	2.49		2.49	2.49	2.49	
9.0	2.25	2.25	2.25		2.25	2.25	2.25	
9.5	2.04	2.04	2.04		2.04	2.04	2.04	
10.0	1.86	1.86	1.86		1.85	1.86	1.86	
10.5	1.70	1.70	1.70		1.65	1.70	1.70	
11.0	1.55	1.56	1.56		1.48	1.56	1.56	
11.5	1.41	1.43	1.43		1.33	1.43	1.43	
12.0	1.29	1.31	1.31		1.20	1.31	1.31	
12.5	1.18	1.21	1.21		1.08	1.21	1.21	
13.0	1.08	1.12	1.12		0.98	1.11	1.12	
13.5	0.99	1.04	1.04		0.89	1.02	1.04	
14.0	0.92	0.96	0.96		0.80	0.94	0.96	
14.5	0.85	0.90	0.90		0.73	0.87	0.90	
15.0	0.79	0.84	0.84		0.65	0.80	0.84	
15.5	0.73	0.79	0.79		0.59	0.74	0.79	
16.0	0.68	0.74	0.74		0.53	0.69	0.74	
16.5	0.63	0.69	0.69		0.48	0.64	0.69	
17.0	0.59	0.65	0.65		0.43	0.59	0.64	
17.5	0.55	0.61	0.62		0.39	0.55	0.60	
18.0	0.52	0.57	0.58		0.36	0.51	0.56	

Generally not limiting design - verify by calculation

Generally not limiting design - verify by calculation

- 1B = One mid span brace
- 2B = Two equally spaced braces within the span
- 3B = Three equally spaced braces within the span
- w_s = Uniformly distributed serviceability load (kN/m) for deflection limit of Span/150
- $\phi_b w_u$ = Strength load resistance applied at the centroid (kN/m)

- 2-M12 Grade 4.6 bolts per connection
- 2-M12 Grade 8.8 bolts per connection
- 2-M16 Grade 4.6 bolts per connection
- 2-M16 Grade 8.8 bolts per connection

IMPORTANT

The adequacy of multispan system is very sensitive to actual applied loads. The stated loads in this table are assumed uniform over the full purlin system. Variations in actual project design loadings over the length of the purlin system must be checked specifically by the designer to verify system adequacy.

MULTISPAN CONTINUOUS (END SPAN)

LOAD TABLE – Uniformly Distributed Load

MSS 325/18								
SPAN (m)	INWARDS			Ws kN/m	OUTWARDS			Ws kN/m
	$\phi_b w_u$ kN/m				$\phi_b w_u$ kN/m			
	1B	2B	3B		1B	2B	3B	
3.0								
3.5								
4.0								
4.5								
5.0	7.74	7.74	7.74		7.74	7.74	7.74	
5.5	7.04	7.04	7.04		7.04	7.04	7.04	
6.0	6.15	6.15	6.15		6.15	6.15	6.15	
6.5	5.36	5.36	5.36		5.36	5.36	5.36	
7.0	4.71	4.71	4.71		4.71	4.71	4.71	
7.5	4.10	4.10	4.10		4.10	4.10	4.10	
8.0	3.61	3.61	3.61		3.61	3.61	3.61	
8.5	3.19	3.19	3.19		3.19	3.19	3.19	
9.0	2.85	2.85	2.85		2.85	2.85	2.85	
9.5	2.56	2.56	2.56		2.56	2.56	2.56	
10.0	2.31	2.31	2.31		2.31	2.31	2.31	
10.5	2.09	2.09	2.09		2.09	2.09	2.09	
11.0	1.91	1.91	1.91		1.90	1.91	1.91	
11.5	1.75	1.75	1.75		1.71	1.75	1.75	
12.0	1.60	1.60	1.60		1.55	1.60	1.60	
12.5	1.48	1.48	1.48		1.40	1.48	1.48	
13.0	1.37	1.37	1.37		1.27	1.37	1.37	
13.5	1.26	1.27	1.27		1.16	1.27	1.27	
14.0	1.16	1.18	1.18		1.05	1.18	1.18	
14.5	1.08	1.10	1.10		0.96	1.10	1.10	
15.0	1.00	1.03	1.03		0.87	1.03	1.03	
15.5	0.93	0.96	0.96		0.80	0.95	0.96	
16.0	0.86	0.90	0.90		0.72	0.88	0.90	
16.5	0.81	0.85	0.85		0.65	0.82	0.85	
17.0	0.75	0.80	0.80		0.58	0.76	0.80	
17.5	0.71	0.75	0.75		0.52	0.71	0.75	
18.0	0.66	0.71	0.71		0.47	0.66	0.71	

Generally not limiting design - verify by calculation

Generally not limiting design - verify by calculation

MSS 350/18								
SPAN (m)	INWARDS			Ws kN/m	OUTWARDS			Ws kN/m
	$\phi_b w_u$ kN/m				$\phi_b w_u$ kN/m			
	1B	2B	3B		1B	2B	3B	
3.0								
3.5								
4.0								
4.5								
5.0								
5.5								
6.0	6.10	6.10	6.10		6.10	6.10	6.10	
6.5	5.36	5.36	5.36		5.36	5.36	5.36	
7.0	4.75	4.75	4.75		4.75	4.75	4.75	
7.5	4.23	4.23	4.23		4.23	4.23	4.23	
8.0	3.79	3.79	3.79		3.79	3.79	3.79	
8.5	3.41	3.41	3.41		3.41	3.41	3.41	
9.0	3.08	3.08	3.08		3.08	3.08	3.08	
9.5	2.80	2.80	2.80		2.80	2.80	2.80	
10.0	2.56	2.56	2.56		2.56	2.56	2.56	
10.5	2.34	2.34	2.34		2.34	2.34	2.34	
11.0	2.13	2.13	2.13		2.12	2.13	2.13	
11.5	1.95	1.95	1.95		1.91	1.95	1.95	
12.0	1.79	1.79	1.79		1.73	1.79	1.79	
12.5	1.64	1.65	1.65		1.57	1.65	1.65	
13.0	1.51	1.53	1.53		1.42	1.53	1.53	
13.5	1.40	1.42	1.42		1.29	1.42	1.42	
14.0	1.29	1.32	1.32		1.18	1.32	1.32	
14.5	1.20	1.23	1.23		1.07	1.23	1.23	
15.0	1.11	1.15	1.15		0.98	1.14	1.15	
15.5	1.03	1.07	1.07		0.89	1.06	1.07	
16.0	0.96	1.01	1.01		0.81	0.99	1.01	
16.5	0.89	0.95	0.95		0.73	0.92	0.95	
17.0	0.84	0.89	0.89		0.66	0.86	0.89	
17.5	0.78	0.84	0.84		0.60	0.80	0.84	
18.0	0.73	0.80	0.80		0.54	0.74	0.80	

Generally not limiting design - verify by calculation

Generally not limiting design - verify by calculation

- 1B = One mid span brace
- 2B = Two equally spaced braces within the span
- 3B = Three equally spaced braces within the span
- w_u = Uniformly distributed serviceability load (kN/m) for deflection limit of Span/150
- $\phi_b w_u$ = Strength load resistance applied at the centroid (kN/m)

- 2-M12 Grade 4.6 bolts per connection
- 2-M12 Grade 8.8 bolts per connection
- 2-M16 Grade 4.6 bolts per connection
- 2-M16 Grade 8.8 bolts per connection

IMPORTANT

The adequacy of multispans system is very sensitive to actual applied loads. The stated loads in this table are assumed uniform over the full purlin system. Variations in actual project design loadings over the length of the purlin system must be checked specifically by the designer to verify system adequacy.

MULTISPAN CONTINUOUS (END SPAN)

LOAD TABLE – Uniformly Distributed Load

MSS 350/23								
SPAN (m)	INWARDS			Ws kN/m	OUTWARDS			Ws kN/m
	$\phi_b w_u$ kN/m				$\phi_b w_u$ kN/m			
	1B	2B	3B		1B	2B	3B	
3.0								
3.5								
4.0								
4.5								
5.0								
5.5								
6.0	8.29	8.30	8.29		8.29	8.30	8.29	
6.5	7.66	7.66	7.66		7.66	7.66	7.66	
7.0	7.11	7.11	7.11		7.11	7.11	7.11	
7.5	6.48	6.48	6.48		6.48	6.48	6.48	
8.0	5.70	5.70	5.70		5.70	5.70	5.70	
8.5	5.05	5.05	5.05		5.05	5.05	5.05	
9.0	4.50	4.50	4.50		4.50	4.50	4.50	
9.5	4.04	4.04	4.04		4.04	4.04	4.04	
10.0	3.65	3.65	3.65		3.65	3.65	3.65	
10.5	3.31	3.31	3.31		3.31	3.31	3.31	
11.0	3.01	3.01	3.01		3.01	3.01	3.01	
11.5	2.76	2.76	2.76		2.76	2.76	2.76	
12.0	2.53	2.53	2.53		2.53	2.53	2.53	
12.5	2.33	2.33	2.33		2.33	2.33	2.33	
13.0	2.16	2.16	2.16		2.12	2.16	2.16	
13.5	2.00	2.00	2.00		1.92	2.00	2.00	
14.0	1.86	1.86	1.86		1.75	1.86	1.86	
14.5	1.73	1.73	1.73		1.60	1.73	1.73	
15.0	1.61	1.62	1.62		1.45	1.62	1.62	
15.5	1.50	1.52	1.52		1.28	1.52	1.52	
16.0	1.39	1.43	1.43		1.14	1.43	1.43	
16.5	1.30	1.34	1.34		1.01	1.34	1.34	
17.0	1.21	1.26	1.26		0.90	1.26	1.26	
17.5	1.14	1.19	1.19		0.80	1.19	1.19	
18.0	1.06	1.13	1.13		0.72	1.11	1.13	

MSS 350/24								
SPAN (m)	INWARDS			Ws kN/m	OUTWARDS			Ws kN/m
	$\phi_b w_u$ kN/m				$\phi_b w_u$ kN/m			
	1B	2B	3B		1B	2B	3B	
3.0								
3.5								
4.0								
4.5								
5.0								
5.5								
6.0	8.85	8.85	8.85		8.85	8.85	8.85	
6.5	8.17	8.17	8.17		8.17	8.17	8.17	
7.0	7.58	7.58	7.58		7.58	7.58	7.58	
7.5	7.08	7.08	7.08		7.08	7.08	7.08	
8.0	6.22	6.22	6.22		6.22	6.22	6.22	
8.5	5.51	5.51	5.51		5.51	5.51	5.51	
9.0	4.92	4.92	4.92		4.92	4.92	4.92	
9.5	4.41	4.41	4.41		4.41	4.41	4.41	
10.0	3.98	3.98	3.98		3.98	3.98	3.98	
10.5	3.61	3.61	3.61		3.61	3.61	3.61	
11.0	3.29	3.29	3.29		3.29	3.29	3.29	
11.5	3.01	3.01	3.01		3.01	3.01	3.01	
12.0	2.77	2.77	2.77		2.77	2.77	2.77	
12.5	2.55	2.55	2.55		2.55	2.55	2.55	
13.0	2.36	2.36	2.36		2.35	2.36	2.36	
13.5	2.19	2.19	2.19		2.14	2.19	2.19	
14.0	2.03	2.03	2.03		1.95	2.03	2.03	
14.5	1.89	1.89	1.89		1.77	1.89	1.89	
15.0	1.77	1.77	1.77		1.56	1.77	1.77	
15.5	1.65	1.66	1.66		1.37	1.66	1.66	
16.0	1.54	1.56	1.56		1.21	1.56	1.56	
16.5	1.43	1.46	1.46		1.07	1.46	1.46	
17.0	1.34	1.38	1.38		0.95	1.38	1.38	
17.5	1.25	1.30	1.30		0.85	1.30	1.30	
18.0	1.17	1.23	1.23		0.76	1.23	1.23	

- 1B = One mid span brace
- 2B = Two equally spaced braces within the span
- 3B = Three equally spaced braces within the span
- w_s = Uniformly distributed serviceability load (kN/m) for deflection limit of Span/150
- $\phi_b w_u$ = Strength load resistance applied at the centroid (kN/m)

- 2-M12 Grade 4.6 bolts per connection
- 2-M12 Grade 8.8 bolts per connection
- 2-M16 Grade 4.6 bolts per connection
- 2-M16 Grade 8.8 bolts per connection

IMPORTANT

The adequacy of multispan system is very sensitive to actual applied loads. The stated loads in this table are assumed uniform over the full purlin system. Variations in actual project design loadings over the length of the purlin system must be checked specifically by the designer to verify system adequacy.

MULTISPAN CONTINUOUS (END SPAN)

LOAD TABLE – Uniformly Distributed Load

MSS 350/30								
SPAN (m)	INWARDS			Ws kN/m	OUTWARDS			Ws kN/m
	$\phi_b w_u$ kN/m				$\phi_b w_u$ kN/m			
	1B	2B	3B		1B	2B	3B	
3.0								
3.5								
4.0								
4.5								
5.0								
5.5								
6.0	10.9	10.9	10.9		10.9	10.9	10.9	
6.5	10.0	10.0	10.0		10.0	10.0	10.0	
7.0	9.32	9.32	9.32		9.32	9.32	9.32	
7.5	8.70	8.70	8.70		8.70	8.70	8.70	
8.0	8.16	8.16	8.16		8.16	8.16	8.16	
8.5	7.28	7.28	7.28		7.28	7.28	7.28	
9.0	6.49	6.49	6.49		6.49	6.49	6.49	
9.5	5.83	5.83	5.83		5.83	5.83	5.83	
10.0	5.26	5.26	5.26		5.26	5.26	5.26	
10.5	4.77	4.77	4.77		4.77	4.77	4.77	
11.0	4.35	4.35	4.35		4.35	4.35	4.35	
11.5	3.98	3.98	3.98		3.98	3.98	3.98	
12.0	3.65	3.65	3.65		3.65	3.65	3.65	
12.5	3.37	3.37	3.37		3.37	3.37	3.37	
13.0	3.11	3.11	3.11		3.03	3.11	3.11	
13.5	2.88	2.89	2.89		2.74	2.89	2.89	
14.0	2.64	2.68	2.68		2.46	2.68	2.68	
14.5	2.43	2.50	2.50		2.17	2.50	2.50	
15.0	2.24	2.34	2.34		1.90	2.34	2.34	
15.5	2.07	2.19	2.19		1.67	2.19	2.19	
16.0	1.92	2.05	2.05		1.48	2.05	2.05	
16.5	1.78	1.93	1.93		1.32	1.93	1.93	
17.0	1.65	1.82	1.82		1.17	1.82	1.82	
17.5	1.53	1.72	1.72		1.05	1.71	1.72	
18.0	1.43	1.62	1.62		0.94	1.59	1.62	

MSS 400/20								
SPAN (m)	INWARDS			Ws kN/m	OUTWARDS			Ws kN/m
	$\phi_b w_u$ kN/m				$\phi_b w_u$ kN/m			
	1B	2B	3B		1B	2B	3B	
3.0								
3.5								
4.0								
4.5								
5.0								
5.5								
6.0	7.19	7.19	7.19		7.19	7.19	7.19	
6.5	6.42	6.42	6.42		6.42	6.42	6.42	
7.0	5.75	5.75	5.75		5.75	5.75	5.75	
7.5	5.17	5.17	5.17		5.17	5.17	5.17	
8.0	4.67	4.67	4.67		4.67	4.67	4.67	
8.5	4.24	4.24	4.24		4.24	4.24	4.24	
9.0	3.86	3.86	3.86		3.86	3.86	3.86	
9.5	3.53	3.53	3.53		3.53	3.53	3.53	
10.0	3.24	3.24	3.24		3.24	3.24	3.24	
10.5	2.98	2.98	2.98		2.98	2.98	2.98	
11.0	2.76	2.76	2.76		2.76	2.76	2.76	
11.5	2.55	2.55	2.55		2.55	2.55	2.55	
12.0	2.37	2.37	2.37		2.36	2.37	2.37	
12.5	2.20	2.20	2.20		2.14	2.20	2.20	
13.0	2.04	2.06	2.06		1.95	2.06	2.06	
13.5	1.88	1.92	1.92		1.78	1.92	1.92	
14.0	1.73	1.78	1.78		1.62	1.78	1.78	
14.5	1.60	1.66	1.66		1.48	1.66	1.66	
15.0	1.49	1.55	1.55		1.35	1.55	1.55	
15.5	1.38	1.45	1.45		1.24	1.45	1.45	
16.0	1.29	1.36	1.36		1.12	1.35	1.36	
16.5	1.20	1.28	1.28		1.01	1.25	1.28	
17.0	1.13	1.21	1.21		0.92	1.17	1.21	
17.5	1.05	1.14	1.14		0.83	1.09	1.14	
18.0	0.99	1.08	1.08		0.76	1.02	1.08	

- 1B = One mid span brace
- 2B = Two equally spaced braces within the span
- 3B = Three equally spaced braces within the span
- w_s = Uniformly distributed serviceability load (kN/m) for deflection limit of Span/150
- $\phi_b w_u$ = Strength load resistance applied at the centroid (kN/m)

- 2-M12 Grade 4.6 bolts per connection
- 2-M12 Grade 8.8 bolts per connection
- 2-M16 Grade 4.6 bolts per connection
- 2-M16 Grade 8.8 bolts per connection

IMPORTANT

The adequacy of multispans system is very sensitive to actual applied loads. The stated loads in this table are assumed uniform over the full purlin system. Variations in actual project design loadings over the length of the purlin system must be checked specifically by the designer to verify system adequacy.

MULTISPAN CONTINUOUS (END SPAN)

LOAD TABLE – Uniformly Distributed Load

MSS 400/23								
SPAN (m)	INWARDS			Ws kN/m	OUTWARDS			Ws kN/m
	$\phi_b w_u$ kN/m				$\phi_b w_u$ kN/m			
	1B	2B	3B		1B	2B	3B	
3.0								
3.5								
4.0								
4.5								
5.0								
5.5								
6.0	8.29	8.30	8.29		8.29	8.30	8.29	
6.5	7.66	7.66	7.66		7.66	7.66	7.66	
7.0	7.11	7.11	7.11		7.11	7.11	7.11	
7.5	6.64	6.64	6.64		6.64	6.64	6.64	
8.0	6.22	6.22	6.22		6.22	6.22	6.22	
8.5	5.65	5.65	5.65		5.65	5.65	5.65	
9.0	5.14	5.14	5.14		5.14	5.14	5.14	
9.5	4.69	4.69	4.69		4.69	4.69	4.69	
10.0	4.26	4.26	4.26		4.26	4.26	4.26	
10.5	3.86	3.86	3.86		3.86	3.86	3.86	
11.0	3.52	3.52	3.52		3.52	3.52	3.52	
11.5	3.22	3.22	3.22		3.22	3.22	3.22	
12.0	2.96	2.96	2.96		2.96	2.96	2.96	
12.5	2.72	2.72	2.72		2.71	2.72	2.72	
13.0	2.52	2.52	2.52		2.46	2.52	2.52	
13.5	2.34	2.34	2.34		2.24	2.34	2.34	
14.0	2.17	2.17	2.17		2.04	2.17	2.17	
14.5	2.01	2.02	2.02		1.86	2.02	2.02	
15.0	1.86	1.89	1.89		1.70	1.89	1.89	
15.5	1.73	1.77	1.77		1.55	1.77	1.77	
16.0	1.61	1.66	1.66		1.39	1.66	1.66	
16.5	1.50	1.56	1.56		1.23	1.56	1.56	
17.0	1.40	1.47	1.47		1.10	1.47	1.47	
17.5	1.31	1.39	1.39		0.98	1.38	1.39	
18.0	1.22	1.31	1.31		0.88	1.29	1.31	

Generally not limiting design - verify by calculation

Generally not limiting design - verify by calculation

MSS 400/24								
SPAN (m)	INWARDS			Ws kN/m	OUTWARDS			Ws kN/m
	$\phi_b w_u$ kN/m				$\phi_b w_u$ kN/m			
	1B	2B	3B		1B	2B	3B	
3.0								
3.5								
4.0								
4.5								
5.0								
5.5								
6.0	8.85	8.85	8.85		8.85	8.85	8.85	
6.5	8.17	8.17	8.17		8.17	8.17	8.17	
7.0	7.58	7.58	7.58		7.58	7.58	7.58	
7.5	7.08	7.08	7.08		7.08	7.08	7.08	
8.0	6.64	6.64	6.64		6.64	6.64	6.64	
8.5	6.25	6.25	6.25		6.25	6.25	6.25	
9.0	5.74	5.74	5.74		5.74	5.74	5.74	
9.5	5.15	5.15	5.15		5.15	5.15	5.15	
10.0	4.65	4.65	4.65		4.65	4.65	4.65	
10.5	4.22	4.22	4.22		4.22	4.22	4.22	
11.0	3.84	3.84	3.84		3.84	3.84	3.84	
11.5	3.52	3.52	3.52		3.52	3.52	3.52	
12.0	3.23	3.23	3.23		3.23	3.23	3.23	
12.5	2.98	2.98	2.98		2.98	2.98	2.98	
13.0	2.75	2.75	2.75		2.73	2.75	2.75	
13.5	2.55	2.55	2.55		2.48	2.55	2.55	
14.0	2.37	2.37	2.37		2.26	2.37	2.37	
14.5	2.21	2.21	2.21		2.06	2.21	2.21	
15.0	2.05	2.07	2.07		1.88	2.07	2.07	
15.5	1.90	1.94	1.94		1.68	1.94	1.94	
16.0	1.77	1.82	1.82		1.48	1.82	1.82	
16.5	1.65	1.71	1.71		1.31	1.71	1.71	
17.0	1.54	1.61	1.61		1.17	1.61	1.61	
17.5	1.44	1.52	1.52		1.04	1.52	1.52	
18.0	1.34	1.44	1.44		0.94	1.43	1.44	

Generally not limiting design - verify by calculation

Generally not limiting design - verify by calculation

- 1B = One mid span brace
- 2B = Two equally spaced braces within the span
- 3B = Three equally spaced braces within the span
- w_s = Uniformly distributed serviceability load (kN/m) for deflection limit of Span/150
- $\phi_b w_u$ = Strength load resistance applied at the centroid (kN/m)

- 2-M12 Grade 4.6 bolts per connection
- 2-M12 Grade 8.8 bolts per connection
- 2-M16 Grade 4.6 bolts per connection
- 2-M16 Grade 8.8 bolts per connection

IMPORTANT

The adequacy of multispan system is very sensitive to actual applied loads. The stated loads in this table are assumed uniform over the full purlin system. Variations in actual project design loadings over the length of the purlin system must be checked specifically by the designer to verify system adequacy.

MULTISPAN CONTINUOUS (END SPAN)

LOAD TABLE – Uniformly Distributed Load

MSS 400/30										
SPAN (m)	INWARDS				Ws kN/m	OUTWARDS				Ws kN/m
	$\phi_b w_u$ kN/m			Ws kN/m		$\phi_b w_u$ kN/m			Ws kN/m	
	1B	2B	3B			1B	2B	3B		
3.0										
3.5										
4.0										
4.5										
5.0										
5.5										
6.0	10.9	10.9	10.9			10.9	10.9	10.9		
6.5	10.0	10.0	10.0			10.0	10.0	10.0		
7.0	9.32	9.32	9.32			9.32	9.32	9.32		
7.5	8.70	8.70	8.70			8.70	8.70	8.70		
8.0	8.16	8.16	8.16			8.16	8.16	8.16		
8.5	7.68	7.68	7.68			7.68	7.68	7.68		
9.0	7.25	7.25	7.25			7.25	7.25	7.25		
9.5	6.82	6.82	6.82			6.82	6.82	6.82		
10.0	6.16	6.16	6.16			6.16	6.16	6.16		
10.5	5.59	5.59	5.59			5.59	5.59	5.59		
11.0	5.09	5.09	5.09			5.09	5.09	5.09		
11.5	4.66	4.66	4.66			4.66	4.66	4.66		
12.0	4.28	4.28	4.28			4.28	4.28	4.28		
12.5	3.94	3.94	3.94			3.94	3.94	3.94		
13.0	3.64	3.64	3.64			3.64	3.64	3.64		
13.5	3.38	3.38	3.38			3.34	3.38	3.38		
14.0	3.14	3.14	3.14			3.02	3.14	3.14		
14.5	2.93	2.93	2.93			2.65	2.93	2.93		
15.0	2.70	2.74	2.74			2.33	2.74	2.74		
15.5	2.49	2.56	2.56			2.05	2.56	2.56		
16.0	2.30	2.41	2.41			1.81	2.41	2.41		
16.5	2.13	2.26	2.26			1.61	2.26	2.26		
17.0	1.98	2.13	2.13			1.43	2.13	2.13		
17.5	1.84	2.01	2.01			1.28	2.01	2.01		
18.0	1.71	1.90	1.90			1.15	1.90	1.90		

Generally not limiting design - verify by calculation

Generally not limiting design - verify by calculation

- 1B = One mid span brace
- 2B = Two equally spaced braces within the span
- 3B = Three equally spaced braces within the span
- w_s = Uniformly distributed serviceability load (kN/m) for deflection limit of Span/150
- $\phi_b w_u$ = Strength load resistance applied at the centroid (kN/m)

- 2-M12 Grade 4.6 bolts per connection
- 2-M12 Grade 8.8 bolts per connection
- 2-M16 Grade 4.6 bolts per connection
- 2-M16 Grade 8.8 bolts per connection

IMPORTANT

The adequacy of multispans system is very sensitive to actual applied loads. The stated loads in this table are assumed uniform over the full purlin system. Variations in actual project design loadings over the length of the purlin system must be checked specifically by the designer to verify system adequacy.

MULTISPAN CONTINUOUS (INTERNAL SPANS)

LOAD TABLE – Uniformly Distributed Load

MSS 150/12								
SPAN (m)	INWARDS			Ws kN/m	OUTWARDS			Ws kN/m
	$\phi_b w_u$ kN/m				$\phi_b w_u$ kN/m			
	1B	2B	3B		1B	2B	3B	
3.0	8.20	8.20	8.20	Generally not limiting design - verify by calculation	8.22	8.22	8.22	Generally not limiting design - verify by calculation
3.5	6.03	6.03	6.03		6.04	6.04	6.04	
4.0	4.61	4.61	4.61		4.62	4.62	4.62	
4.5	3.64	3.64	3.64		3.65	3.65	3.65	
5.0	2.95	2.95	2.95		2.96	2.96	2.96	
5.5	2.44	2.44	2.44		2.45	2.45	2.45	
6.0	2.05	2.05	2.05		2.05	2.05	2.05	
6.5	1.75	1.75	1.75		1.75	1.75	1.75	
7.0	1.51	1.51	1.51		1.51	1.51	1.51	
7.5	1.31	1.31	1.31		1.31	1.32	1.32	
8.0	1.15	1.15	1.15		1.13	1.16	1.16	
8.5	1.02	1.02	1.02		0.97	1.02	1.02	
9.0	0.91	0.91	0.91		0.84	0.91	0.91	
9.5	0.82	0.82	0.82		0.72	0.82	0.82	
10.0	0.74	0.74	0.74		0.65	0.74	0.74	
10.5	0.67	0.67	0.67		0.59	0.66	0.67	
11.0	0.61	0.61	0.61		0.53	0.59	0.61	
11.5								
12.0								
12.5								
13.0								
13.5								
14.0								
14.5								
15.0								
15.5								
16.0								
16.5								
17.0								
17.5								
18.0								

MSS 150/15								
SPAN (m)	INWARDS			Ws kN/m	OUTWARDS			Ws kN/m
	$\phi_b w_u$ kN/m				$\phi_b w_u$ kN/m			
	1B	2B	3B		1B	2B	3B	
3.0	11.2	11.2	11.2	Generally not limiting design - verify by calculation	11.2	11.2	11.2	Generally not limiting design - verify by calculation
3.5	8.24	8.24	8.24		8.25	8.25	8.25	
4.0	6.31	6.31	6.31		6.32	6.32	6.32	
4.5	4.98	4.98	4.98		4.99	4.99	4.99	
5.0	4.04	4.04	4.04		4.04	4.04	4.04	
5.5	3.34	3.34	3.34		3.34	3.34	3.34	
6.0	2.80	2.80	2.80		2.81	2.81	2.81	
6.5	2.39	2.39	2.39		2.39	2.39	2.39	
7.0	2.06	2.06	2.06		2.06	2.06	2.06	
7.5	1.80	1.80	1.80		1.80	1.80	1.80	
8.0	1.58	1.58	1.58		1.54	1.58	1.58	
8.5	1.40	1.40	1.40		1.32	1.40	1.40	
9.0	1.25	1.25	1.25		1.14	1.25	1.25	
9.5	1.12	1.12	1.12		0.99	1.12	1.12	
10.0	1.01	1.01	1.01		0.89	1.01	1.01	
10.5	0.92	0.92	0.92		0.80	0.91	0.92	
11.0	0.84	0.84	0.84		0.73	0.81	0.84	
11.5								
12.0								
12.5								
13.0								
13.5								
14.0								
14.5								
15.0								
15.5								
16.0								
16.5								
17.0								
17.5								
18.0								

- 1B = One mid span brace
- 2B = Two equally spaced braces within the span
- 3B = Three equally spaced braces within the span
- w_s = Uniformly distributed serviceability load (kN/m) for deflection limit of Span/150
- $\phi_b w_u$ = Strength load resistance applied at the centroid (kN/m)

- 2-M12 Grade 4.6 bolts per connection
- 2-M12 Grade 8.8 bolts per connection
- 2-M16 Grade 4.6 bolts per connection
- 2-M16 Grade 8.8 bolts per connection

IMPORTANT

The adequacy of multispans system is very sensitive to actual applied loads. The stated loads in this table are assumed uniform over the full purlin system. Variations in actual project design loadings over the length of the purlin system must be checked specifically by the designer to verify system adequacy.

MULTISPAN CONTINUOUS (INTERNAL SPANS)

LOAD TABLE – Uniformly Distributed Load

MSS 150/18								
SPAN (m)	INWARDS			Ws kN/m	OUTWARDS			Ws kN/m
	$\phi_b w_u$ kN/m				$\phi_b w_u$ kN/m			
	1B	2B	3B		1B	2B	3B	
3.0	13.4	13.4	13.4	Generally not limiting design - verify by calculation	13.4	13.4	13.4	Generally not limiting design - verify by calculation
3.5	9.84	9.84	9.84		9.86	9.86	9.86	
4.0	7.53	7.53	7.53		7.55	7.55	7.55	
4.5	5.95	5.95	5.95		5.97	5.97	5.97	
5.0	4.82	4.82	4.82		4.83	4.83	4.83	
5.5	3.99	3.99	3.99		3.99	3.99	3.99	
6.0	3.35	3.35	3.35		3.36	3.36	3.36	
6.5	2.86	2.86	2.86		2.86	2.86	2.86	
7.0	2.46	2.46	2.46		2.47	2.47	2.47	
7.5	2.14	2.14	2.14		2.13	2.15	2.15	
8.0	1.88	1.88	1.88		1.82	1.89	1.89	
8.5	1.67	1.67	1.67		1.56	1.67	1.67	
9.0	1.49	1.49	1.49		1.35	1.49	1.49	
9.5	1.34	1.34	1.34		1.09	1.34	1.34	
10.0	1.21	1.21	1.21		1.05	1.21	1.21	
10.5	1.09	1.09	1.09		0.95	1.08	1.10	
11.0	0.99	1.00	1.00		0.86	0.96	1.00	
11.5								
12.0								
12.5								
13.0								
13.5								
14.0								
14.5								
15.0								
15.5								
16.0								
16.5								
17.0								
17.5								
18.0								

MSS 150/23								
SPAN (m)	INWARDS			Ws kN/m	OUTWARDS			Ws kN/m
	$\phi_b w_u$ kN/m				$\phi_b w_u$ kN/m			
	1B	2B	3B		1B	2B	3B	
3.0	18.4	18.4	18.4	Generally not limiting design - verify by calculation	18.5	18.5	18.5	Generally not limiting design - verify by calculation
3.5	13.6	13.6	13.6		13.6	13.6	13.6	
4.0	10.4	10.4	10.4		10.4	10.4	10.4	
4.5	8.20	8.20	8.20		8.22	8.22	8.21	
5.0	6.64	6.64	6.64		6.66	6.66	6.66	
5.5	5.49	5.49	5.49		5.50	5.50	5.50	
6.0	4.61	4.61	4.61		4.60	4.62	4.62	
6.5	3.93	3.93	3.93		3.84	3.94	3.94	
7.0	3.35	3.39	3.39		3.24	3.40	3.40	
7.5	2.88	2.95	2.95		2.74	2.96	2.96	
8.0	2.51	2.59	2.59		2.34	2.60	2.60	
8.5	2.20	2.30	2.30		2.01	2.29	2.30	
9.0	1.94	2.05	2.05		1.73	2.00	2.05	
9.5	1.72	1.84	1.84		1.43	1.77	1.84	
10.0	1.54	1.66	1.66		1.33	1.56	1.67	
10.5	1.38	1.51	1.51		1.21	1.39	1.50	
11.0	1.25	1.38	1.37		1.10	1.24	1.35	
11.5								
12.0								
12.5								
13.0								
13.5								
14.0								
14.5								
15.0								
15.5								
16.0								
16.5								
17.0								
17.5								
18.0								

- 1B = One mid span brace
- 2B = Two equally spaced braces within the span
- 3B = Three equally spaced braces within the span
- w_s = Uniformly distributed serviceability load (kN/m) for deflection limit of Span/150
- $\phi_b w_u$ = Strength load resistance applied at the centroid (kN/m)

- 2-M12 Grade 4.6 bolts per connection
- 2-M12 Grade 8.8 bolts per connection
- 2-M16 Grade 4.6 bolts per connection
- 2-M16 Grade 8.8 bolts per connection

IMPORTANT

The adequacy of multispan system is very sensitive to actual applied loads. The stated loads in this table are assumed uniform over the full purlin system. Variations in actual project design loadings over the length of the purlin system must be checked specifically by the designer to verify system adequacy.

MULTISPAN CONTINUOUS (INTERNAL SPANS)

LOAD TABLE – Uniformly Distributed Load

MSS 200/12								
SPAN (m)	INWARDS			Ws kN/m	OUTWARDS			Ws kN/m
	$\phi_b w_u$ kN/m				$\phi_b w_u$ kN/m			
	1B	2B	3B		1B	2B	3B	
3.0	9.49	9.49	9.49	Generally not limiting design - verify by calculation	9.45	9.45	9.45	Generally not limiting design - verify by calculation
3.5	7.43	7.43	7.43		7.41	7.41	7.41	
4.0	5.96	5.96	5.96		5.95	5.95	5.95	
4.5	4.95	4.95	4.95		4.95	4.95	4.95	
5.0	4.16	4.16	4.16		4.20	4.20	4.20	
5.5	3.44	3.44	3.44		3.47	3.47	3.47	
6.0	2.89	2.89	2.89		2.91	2.91	2.91	
6.5	2.46	2.46	2.46		2.48	2.48	2.48	
7.0	2.12	2.12	2.12		2.14	2.14	2.14	
7.5	1.85	1.85	1.85		1.86	1.86	1.86	
8.0	1.63	1.63	1.63		1.62	1.64	1.64	
8.5	1.44	1.44	1.44		1.40	1.45	1.45	
9.0	1.28	1.28	1.28		1.22	1.30	1.30	
9.5	1.15	1.15	1.15		1.07	1.16	1.16	
10.0	1.04	1.04	1.04		0.94	1.05	1.05	
10.5	0.94	0.94	0.94		0.83	0.95	0.95	
11.0	0.86	0.86	0.86		0.73	0.86	0.87	
11.5	0.79	0.79	0.79		0.65	0.77	0.79	
12.0	0.72	0.72	0.72	0.59	0.70	0.73		
12.5	0.66	0.67	0.67	0.54	0.63	0.67		
13.0	0.60	0.62	0.62	0.50	0.57	0.62		
13.5	0.55	0.57	0.57	0.46	0.52	0.57		
14.0	0.51	0.53	0.53	0.43	0.47	0.52		
14.5	0.47	0.50	0.49	0.39	0.43	0.48		
15.0	0.44	0.46	0.46	0.35	0.39	0.45		
15.5								
16.0								
16.5								
17.0								
17.5								
18.0								

MSS 200/15								
SPAN (m)	INWARDS			Ws kN/m	OUTWARDS			Ws kN/m
	$\phi_b w_u$ kN/m				$\phi_b w_u$ kN/m			
	1B	2B	3B		1B	2B	3B	
3.0	14.2	14.2	14.2	Generally not limiting design - verify by calculation	14.2	14.2	14.2	Generally not limiting design - verify by calculation
3.5	11.7	11.7	11.7		11.8	11.8	11.8	
4.0	8.96	8.96	8.96		9.04	9.04	9.04	
4.5	7.08	7.08	7.08		7.14	7.15	7.15	
5.0	5.74	5.74	5.74		5.78	5.78	5.78	
5.5	4.74	4.74	4.74		4.78	4.78	4.78	
6.0	3.98	3.98	3.98		4.02	4.02	4.02	
6.5	3.40	3.40	3.40		3.42	3.42	3.42	
7.0	2.93	2.93	2.93		2.95	2.95	2.95	
7.5	2.55	2.55	2.55		2.57	2.57	2.57	
8.0	2.24	2.24	2.24		2.26	2.26	2.26	
8.5	1.98	1.98	1.98		2.00	2.00	2.00	
9.0	1.77	1.77	1.77		1.79	1.79	1.79	
9.5	1.59	1.59	1.59		1.58	1.60	1.60	
10.0	1.43	1.43	1.43		1.39	1.45	1.45	
10.5	1.30	1.30	1.30		1.23	1.31	1.31	
11.0	1.19	1.19	1.19		1.11	1.20	1.20	
11.5	1.08	1.08	1.08		1.01	1.09	1.09	
12.0	1.00	1.00	1.00	0.92	1.00	1.01		
12.5	0.92	0.92	0.92	0.84	0.93	0.93		
13.0	0.85	0.85	0.85	0.76	0.84	0.86		
13.5	0.79	0.79	0.79	0.68	0.77	0.79		
14.0	0.73	0.73	0.73	0.62	0.70	0.74		
14.5	0.68	0.68	0.68	0.55	0.64	0.69		
15.0	0.63	0.64	0.64	0.49	0.59	0.64		
15.5								
16.0								
16.5								
17.0								
17.5								
18.0								

1B = One mid span brace
 2B = Two equally spaced braces within the span
 3B = Three equally spaced braces within the span
 w_s = Uniformly distributed serviceability load (kN/m) for deflection limit of Span/150
 $\phi_b w_u$ = Strength load resistance applied at the centroid (kN/m)

- 2-M12 Grade 4.6 bolts per connection
- 2-M12 Grade 8.8 bolts per connection
- 2-M16 Grade 4.6 bolts per connection
- 2-M16 Grade 8.8 bolts per connection

IMPORTANT

The adequacy of multispan system is very sensitive to actual applied loads. The stated loads in this table are assumed uniform over the full purlin system. Variations in actual project design loadings over the length of the purlin system must be checked specifically by the designer to verify system adequacy.

MULTISPAN CONTINUOUS (INTERNAL SPANS)

LOAD TABLE – Uniformly Distributed Load

MSS 200/18								
SPAN (m)	INWARDS			Ws kN/m	OUTWARDS			Ws kN/m
	$\phi_b w_u$ kN/m				$\phi_b w_u$ kN/m			
	1B	2B	3B		1B	2B	3B	
3.0	15.9	15.9	15.9	Generally not limiting design - verify by calculation	15.9	15.9	15.9	Generally not limiting design - verify by calculation
3.5	13.9	13.9	13.9		13.9	13.9	13.9	
4.0	10.8	10.8	10.8		10.9	10.9	10.9	
4.5	8.55	8.55	8.55		8.62	8.62	8.62	
5.0	6.92	6.92	6.92		6.99	6.99	6.99	
5.5	5.72	5.72	5.72		5.77	5.77	5.77	
6.0	4.81	4.81	4.81		4.85	4.85	4.85	
6.5	4.10	4.10	4.10		4.14	4.14	4.14	
7.0	3.53	3.53	3.53		3.57	3.57	3.57	
7.5	3.08	3.08	3.08		3.10	3.10	3.10	
8.0	2.71	2.71	2.71		2.73	2.73	2.73	
8.5	2.40	2.40	2.40		2.42	2.42	2.42	
9.0	2.14	2.14	2.14		2.16	2.16	2.16	
9.5	1.92	1.92	1.92		1.93	1.93	1.93	
10.0	1.73	1.73	1.73		1.69	1.75	1.75	
10.5	1.57	1.57	1.57		1.48	1.58	1.58	
11.0	1.43	1.43	1.43		1.32	1.44	1.44	
11.5	1.31	1.31	1.31		1.21	1.32	1.32	
12.0	1.20	1.20	1.20	1.11	1.21	1.21		
12.5	1.11	1.11	1.11	1.02	1.12	1.12		
13.0	1.03	1.03	1.03	0.92	1.03	1.03		
13.5	0.95	0.95	0.95	0.82	0.93	0.96		
14.0	0.89	0.88	0.88	0.74	0.85	0.89		
14.5	0.82	0.82	0.82	0.67	0.76	0.83		
15.0	0.76	0.77	0.77	0.60	0.70	0.78		
15.5								
16.0								
16.5								
17.0								
17.5								
18.0								

MSS 200/23								
SPAN (m)	INWARDS			Ws kN/m	OUTWARDS			Ws kN/m
	$\phi_b w_u$ kN/m				$\phi_b w_u$ kN/m			
	1B	2B	3B		1B	2B	3B	
3.0	20.4	20.4	20.4	Generally not limiting design - verify by calculation	20.4	20.4	20.4	Generally not limiting design - verify by calculation
3.5	18.0	18.0	18.0		18.0	18.0	18.0	
4.0	15.1	15.1	15.1		15.2	15.2	15.2	
4.5	11.9	11.9	11.9		12.0	12.0	12.0	
5.0	9.67	9.67	9.67		9.76	9.76	9.76	
5.5	7.99	7.99	7.99		8.06	8.06	8.06	
6.0	6.72	6.72	6.72		6.78	6.78	6.78	
6.5	5.72	5.72	5.72		5.77	5.77	5.77	
7.0	4.94	4.94	4.94		4.98	4.98	4.98	
7.5	4.30	4.30	4.30		4.34	4.33	4.33	
8.0	3.78	3.78	3.78		3.78	3.81	3.81	
8.5	3.35	3.35	3.35		3.30	3.38	3.38	
9.0	2.97	2.99	2.99		2.88	3.01	3.01	
9.5	2.65	2.68	2.68		2.54	2.70	2.70	
10.0	2.37	2.42	2.42		2.24	2.44	2.44	
10.5	2.14	2.19	2.19		1.97	2.21	2.21	
11.0	1.94	2.00	2.00		1.79	2.00	2.02	
11.5	1.76	1.83	1.83		1.63	1.81	1.84	
12.0	1.60	1.68	1.68	1.49	1.64	1.69		
12.5	1.47	1.55	1.55	1.35	1.49	1.56		
13.0	1.35	1.43	1.43	1.21	1.36	1.44		
13.5	1.24	1.33	1.33	1.09	1.24	1.33		
14.0	1.15	1.24	1.23	0.97	1.10	1.23		
14.5	1.06	1.15	1.15	0.88	0.98	1.14		
15.0	0.97	1.07	1.07	0.79	0.95	1.05		
15.5								
16.0								
16.5								
17.0								
17.5								
18.0								

- 1B = One mid span brace
- 2B = Two equally spaced braces within the span
- 3B = Three equally spaced braces within the span
- w_s = Uniformly distributed serviceability load (kN/m) for deflection limit of Span/150
- $\phi_b w_u$ = Strength load resistance applied at the centroid (kN/m)

- 2-M12 Grade 4.6 bolts per connection
- 2-M12 Grade 8.8 bolts per connection
- 2-M16 Grade 4.6 bolts per connection
- 2-M16 Grade 8.8 bolts per connection

IMPORTANT

The adequacy of multispan system is very sensitive to actual applied loads. The stated loads in this table are assumed uniform over the full purlin system. Variations in actual project design loadings over the length of the purlin system must be checked specifically by the designer to verify system adequacy.

MULTISPAN CONTINUOUS (INTERNAL SPANS)

LOAD TABLE – Uniformly Distributed Load

MSS 250/13								
SPAN (m)	INWARDS			Ws kN/m	OUTWARDS			Ws kN/m
	$\phi_b w_u$ kN/m				$\phi_b w_u$ kN/m			
	1B	2B	3B		1B	2B	3B	
3.0								
3.5								
4.0	8.22	8.22	8.22		8.19	8.19	8.19	
4.5	6.80	6.80	6.80		6.78	6.78	6.78	
5.0	5.71	5.71	5.71		5.70	5.70	5.70	
5.5	4.86	4.86	4.86		4.86	4.86	4.86	
6.0	4.18	4.18	4.18		4.18	4.18	4.18	
6.5	3.63	3.63	3.63		3.64	3.64	3.64	
7.0	3.20	3.20	3.20		3.20	3.21	3.21	
7.5	2.85	2.85	2.85		2.88	2.86	2.86	
8.0	2.54	2.54	2.54		2.52	2.56	2.56	
8.5	2.24	2.26	2.26		2.20	2.28	2.28	
9.0	1.98	2.01	2.01		1.93	2.03	2.03	
9.5	1.77	1.80	1.80		1.70	1.82	1.82	
10.0	1.59	1.63	1.63		1.50	1.64	1.64	
10.5	1.43	1.48	1.48		1.33	1.48	1.49	
11.0	1.30	1.35	1.35		1.19	1.33	1.36	
11.5	1.18	1.23	1.23		1.06	1.21	1.24	
12.0	1.08	1.13	1.13		0.95	1.09	1.14	
12.5	0.99	1.04	1.04		0.85	1.00	1.05	
13.0	0.91	0.97	0.96		0.74	0.91	0.97	
13.5	0.83	0.90	0.89		0.71	0.83	0.89	
14.0	0.77	0.83	0.83		0.65	0.76	0.82	
14.5	0.71	0.77	0.77		0.57	0.70	0.76	
15.0	0.66	0.71	0.72		0.53	0.64	0.70	
15.5	0.62	0.66	0.68		0.45	0.59	0.65	
16.0	0.57	0.62	0.64		0.46	0.54	0.60	
16.5	0.53	0.58	0.60		0.44	0.50	0.56	
17.0	0.50	0.54	0.56		0.41	0.45	0.52	
17.5								
18.0								

MSS 250/15								
SPAN (m)	INWARDS			Ws kN/m	OUTWARDS			Ws kN/m
	$\phi_b w_u$ kN/m				$\phi_b w_u$ kN/m			
	1B	2B	3B		1B	2B	3B	
3.0								
3.5								
4.0	10.6	10.6	10.6		10.7	10.7	10.7	
4.5	8.93	8.93	8.93		8.92	8.92	8.92	
5.0	7.47	7.47	7.47		7.46	7.46	7.46	
5.5	6.41	6.41	6.42		6.41	6.41	6.42	
6.0	5.55	5.55	5.55		5.58	5.58	5.58	
6.5	4.74	4.74	4.74		4.78	4.78	4.78	
7.0	4.09	4.09	4.09		4.12	4.12	4.12	
7.5	3.56	3.56	3.56		3.59	3.59	3.59	
8.0	3.13	3.13	3.13		3.16	3.16	3.16	
8.5	2.77	2.77	2.77		2.77	2.79	2.79	
9.0	2.47	2.47	2.47		2.43	2.49	2.49	
9.5	2.22	2.22	2.22		2.14	2.24	2.24	
10.0	1.98	2.01	2.01		1.90	2.02	2.02	
10.5	1.79	1.82	1.82		1.68	1.83	1.83	
11.0	1.62	1.65	1.65		1.50	1.67	1.67	
11.5	1.47	1.52	1.52		1.34	1.52	1.53	
12.0	1.34	1.39	1.39		1.20	1.38	1.40	
12.5	1.23	1.28	1.28		1.08	1.26	1.29	
13.0	1.13	1.19	1.19		0.94	1.15	1.20	
13.5	1.04	1.10	1.10		0.88	1.05	1.11	
14.0	0.96	1.02	1.02		0.81	0.96	1.03	
14.5	0.89	0.95	0.95		0.76	0.88	0.95	
15.0	0.82	0.90	0.89		0.71	0.81	0.88	
15.5	0.77	0.84	0.83		0.66	0.75	0.82	
16.0	0.71	0.78	0.78		0.61	0.69	0.76	
16.5	0.67	0.73	0.74		0.56	0.63	0.71	
17.0	0.62	0.68	0.69		0.52	0.58	0.66	
17.5								
18.0								

1B = One mid span brace
 2B = Two equally spaced braces within the span
 3B = Three equally spaced braces within the span
 w_s = Uniformly distributed serviceability load (kN/m) for deflection limit of Span/150
 $\phi_b w_u$ = Strength load resistance applied at the centroid (kN/m)

- 2-M12 Grade 4.6 bolts per connection
- 2-M12 Grade 8.8 bolts per connection
- 2-M16 Grade 4.6 bolts per connection
- 2-M16 Grade 8.8 bolts per connection

IMPORTANT

The adequacy of multispan system is very sensitive to actual applied loads. The stated loads in this table are assumed uniform over the full purlin system. Variations in actual project design loadings over the length of the purlin system must be checked specifically by the designer to verify system adequacy.

MULTISPAN CONTINUOUS (INTERNAL SPANS)

LOAD TABLE – Uniformly Distributed Load

MSS 250/18								
SPAN (m)	INWARDS			Ws kN/m	OUTWARDS			Ws kN/m
	$\phi_b w_u$ kN/m				$\phi_b w_u$ kN/m			
	1B	2B	3B		1B	2B	3B	
3.0								
3.5								
4.0	11.9	11.9	11.9		11.9	11.9	11.9	
4.5	10.9	10.9	10.9		10.9	10.9	10.9	
5.0	9.70	9.70	9.70		9.69	9.69	9.69	
5.5	8.03	8.03	8.03		8.11	8.11	8.11	
6.0	6.75	6.75	6.75		6.81	6.81	6.81	
6.5	5.75	5.75	5.75		5.80	5.80	5.80	
7.0	4.96	4.96	4.96		5.01	5.01	5.01	
7.5	4.32	4.32	4.32		4.36	4.36	4.36	
8.0	3.80	3.80	3.80		3.83	3.83	3.83	
8.5	3.36	3.36	3.36		3.39	3.39	3.39	
9.0	3.00	3.00	3.00		3.03	3.03	3.03	
9.5	2.69	2.69	2.69		2.72	2.72	2.72	
10.0	2.43	2.43	2.43		2.45	2.45	2.45	
10.5	2.20	2.20	2.20		2.20	2.22	2.22	
11.0	2.01	2.01	2.01		1.96	2.03	2.03	
11.5	1.84	1.84	1.84		1.76	1.85	1.85	
12.0	1.69	1.69	1.69		1.58	1.70	1.70	
12.5	1.56	1.56	1.56		1.42	1.57	1.57	
13.0	1.44	1.44	1.44		1.31	1.45	1.45	
13.5	1.33	1.33	1.33		1.20	1.35	1.35	
14.0	1.23	1.24	1.24		1.11	1.25	1.25	
14.5	1.14	1.16	1.16		1.03	1.15	1.17	
15.0	1.06	1.08	1.08		0.96	1.06	1.09	
15.5	0.98	1.01	1.01		0.88	0.98	1.02	
16.0	0.92	0.95	0.95		0.80	0.90	0.96	
16.5	0.86	0.89	0.89		0.74	0.84	0.90	
17.0	0.80	0.84	0.84		0.67	0.77	0.85	
17.5								
18.0								

MSS 250/23								
SPAN (m)	INWARDS			Ws kN/m	OUTWARDS			Ws kN/m
	$\phi_b w_u$ kN/m				$\phi_b w_u$ kN/m			
	1B	2B	3B		1B	2B	3B	
3.0								
3.5								
4.0	15.3	15.3	15.3		15.3	15.3	15.3	
4.5	13.6	13.6	13.5		13.6	13.6	13.6	
5.0	12.6	12.6	12.6		12.6	12.6	12.6	
5.5	11.3	11.3	11.3		11.3	11.3	11.3	
6.0	9.47	9.47	9.47		9.54	9.54	9.54	
6.5	8.06	8.06	8.06		8.14	8.14	8.14	
7.0	6.95	6.95	6.95		7.02	7.02	7.02	
7.5	6.06	6.06	6.06		6.11	6.11	6.11	
8.0	5.32	5.32	5.32		5.37	5.37	5.37	
8.5	4.72	4.72	4.72		4.75	4.75	4.75	
9.0	4.21	4.21	4.21		4.24	4.24	4.24	
9.5	3.77	3.77	3.77		3.81	3.81	3.81	
10.0	3.41	3.41	3.41		3.44	3.44	3.44	
10.5	3.09	3.09	3.09		3.11	3.12	3.12	
11.0	2.82	2.82	2.82		2.77	2.84	2.84	
11.5	2.58	2.58	2.58		2.47	2.60	2.60	
12.0	2.37	2.37	2.37		2.21	2.39	2.39	
12.5	2.18	2.18	2.18		2.01	2.20	2.20	
13.0	2.01	2.02	2.02		1.86	2.03	2.03	
13.5	1.83	1.87	1.87		1.72	1.89	1.89	
14.0	1.69	1.74	1.74		1.59	1.75	1.75	
14.5	1.56	1.62	1.62		1.45	1.63	1.64	
15.0	1.44	1.52	1.52		1.32	1.50	1.53	
15.5	1.34	1.42	1.42		1.20	1.37	1.43	
16.0	1.24	1.33	1.33		1.09	1.26	1.34	
16.5	1.16	1.25	1.25		1.00	1.13	1.26	
17.0	1.08	1.18	1.18		0.91	1.08	1.19	
17.5								
18.0								

- 1B = One mid span brace
- 2B = Two equally spaced braces within the span
- 3B = Three equally spaced braces within the span
- Ws = Uniformly distributed serviceability load (kN/m) for deflection limit of Span/150
- $\phi_b w_u$ = Strength load resistance applied at the centroid (kN/m)

- 2-M12 Grade 4.6 bolts per connection
- 2-M12 Grade 8.8 bolts per connection
- 2-M16 Grade 4.6 bolts per connection
- 2-M16 Grade 8.8 bolts per connection

IMPORTANT

The adequacy of multispan system is very sensitive to actual applied loads. The stated loads in this table are assumed uniform over the full purlin system. Variations in actual project design loadings over the length of the purlin system must be checked specifically by the designer to verify system adequacy.

MULTISPAN CONTINUOUS (INTERNAL SPANS)

LOAD TABLE – Uniformly Distributed Load

MSS 275/15								
SPAN (m)	INWARDS			Ws kN/m	OUTWARDS			Ws kN/m
	$\phi_b w_u$ kN/m				$\phi_b w_u$ kN/m			
	1B	2B	3B		1B	2B	3B	
3.0								
3.5								
4.0								
4.5	8.81	8.81	8.81		8.77	8.77	8.77	
5.0	7.47	7.47	7.47		7.44	7.44	7.43	
5.5	6.40	6.40	6.40		6.38	6.38	6.38	
6.0	5.55	5.55	5.55		5.54	5.54	5.54	
6.5	4.84	4.84	4.84		4.84	4.84	4.84	
7.0	4.27	4.27	4.27		4.27	4.27	4.27	
7.5	3.82	3.82	3.82		3.82	3.82	3.82	
8.0	3.45	3.45	3.45		3.45	3.45	3.45	
8.5	3.10	3.10	3.10		3.12	3.12	3.12	
9.0	2.77	2.77	2.77		2.74	2.79	2.79	
9.5	2.47	2.48	2.48		2.42	2.50	2.50	
10.0	2.21	2.24	2.24		2.14	2.26	2.26	
10.5	1.99	2.03	2.03		1.91	2.05	2.05	
11.0	1.80	1.85	1.85		1.70	1.87	1.87	
11.5	1.64	1.70	1.70		1.53	1.71	1.71	
12.0	1.49	1.56	1.56		1.37	1.56	1.57	
12.5	1.37	1.43	1.43		1.23	1.42	1.45	
13.0	1.26	1.33	1.33		1.11	1.29	1.34	
13.5	1.16	1.23	1.23		1.00	1.18	1.24	
14.0	1.07	1.14	1.14		0.90	1.09	1.15	
14.5	0.99	1.07	1.07		0.83	1.00	1.07	
15.0	0.92	1.00	1.00		0.76	0.92	1.00	
15.5	0.86	0.94	0.93		0.71	0.85	0.92	
16.0	0.80	0.87	0.88		0.66	0.78	0.86	
16.5	0.74	0.82	0.82		0.63	0.72	0.80	
17.0	0.69	0.76	0.78		0.59	0.67	0.74	
17.5								
18.0								

MSS 275/18								
SPAN (m)	INWARDS			Ws kN/m	OUTWARDS			Ws kN/m
	$\phi_b w_u$ kN/m				$\phi_b w_u$ kN/m			
	1B	2B	3B		1B	2B	3B	
3.0								
3.5								
4.0								
4.5	10.6	10.6	10.5		10.6	10.6	10.5	
5.0	9.80	9.80	9.80		9.84	9.84	9.84	
5.5	8.82	8.82	8.82		8.83	8.83	8.83	
6.0	7.57	7.57	7.57		7.64	7.64	7.64	
6.5	6.45	6.45	6.45		6.51	6.51	6.51	
7.0	5.56	5.56	5.56		5.61	5.61	5.61	
7.5	4.85	4.85	4.85		4.89	4.89	4.89	
8.0	4.26	4.26	4.26		4.30	4.30	4.30	
8.5	3.77	3.77	3.77		3.81	3.81	3.81	
9.0	3.36	3.36	3.36		3.40	3.39	3.39	
9.5	3.02	3.02	3.02		3.05	3.05	3.05	
10.0	2.73	2.73	2.73		2.75	2.75	2.75	
10.5	2.47	2.47	2.47		2.47	2.49	2.49	
11.0	2.25	2.25	2.25		2.22	2.27	2.27	
11.5	2.06	2.06	2.06		1.99	2.08	2.08	
12.0	1.89	1.89	1.89		1.79	1.91	1.91	
12.5	1.74	1.75	1.75		1.62	1.76	1.76	
13.0	1.60	1.61	1.61		1.46	1.63	1.63	
13.5	1.48	1.50	1.50		1.33	1.51	1.51	
14.0	1.36	1.39	1.39		1.22	1.40	1.40	
14.5	1.26	1.30	1.30		1.13	1.30	1.31	
15.0	1.17	1.21	1.21		1.05	1.20	1.22	
15.5	1.09	1.14	1.14		0.98	1.10	1.14	
16.0	1.02	1.07	1.07		0.92	1.02	1.07	
16.5	0.95	1.00	1.00		0.85	0.95	1.01	
17.0	0.89	0.94	0.94		0.78	0.88	0.95	
17.5								
18.0								

1B = One mid span brace
 2B = Two equally spaced braces within the span
 3B = Three equally spaced braces within the span
 w_s = Uniformly distributed serviceability load (kN/m) for deflection limit of Span/150
 $\phi_b w_u$ = Strength load resistance applied at the centroid (kN/m)

- 2-M12 Grade 4.6 bolts per connection
- 2-M12 Grade 8.8 bolts per connection
- 2-M16 Grade 4.6 bolts per connection
- 2-M16 Grade 8.8 bolts per connection

IMPORTANT

The adequacy of multispans system is very sensitive to actual applied loads. The stated loads in this table are assumed uniform over the full purlin system. Variations in actual project design loadings over the length of the purlin system must be checked specifically by the designer to verify system adequacy.

MULTISPAN CONTINUOUS (INTERNAL SPANS)

LOAD TABLE – Uniformly Distributed Load

MSS 300/15								
SPAN (m)	INWARDS			Ws kN/m	OUTWARDS			Ws kN/m
	$\phi_b w_u$ kN/m				$\phi_b w_u$ kN/m			
	1B	2B	3B		1B	2B	3B	
3.0								
3.5								
4.0								
4.5								
5.0	7.55	7.55	7.56		7.55	7.55	7.55	
5.5	6.54	6.54	6.54		6.54	6.54	6.54	
6.0	5.73	5.72	5.72		5.73	5.72	5.72	
6.5	5.05	5.05	5.05		5.05	5.05	5.05	
7.0	4.48	4.48	4.48		4.48	4.48	4.48	
7.5	4.00	4.00	4.00		4.00	4.00	4.00	
8.0	3.59	3.59	3.59		3.59	3.59	3.59	
8.5	3.24	3.24	3.24		3.24	3.24	3.24	
9.0	2.94	2.94	2.94		2.94	2.94	2.94	
9.5	2.68	2.68	2.68		2.68	2.68	2.68	
10.0	2.45	2.45	2.45		2.50	2.45	2.45	
10.5	2.27	2.26	2.26		2.29	2.26	2.26	
11.0	2.11	2.09	2.09		2.05	2.09	2.09	
11.5	1.91	1.94	1.94		1.84	1.94	1.94	
12.0	1.75	1.81	1.81		1.66	1.81	1.81	
12.5	1.60	1.67	1.67		1.50	1.67	1.67	
13.0	1.47	1.55	1.55		1.36	1.54	1.55	
13.5	1.35	1.43	1.43		1.24	1.41	1.43	
14.0	1.25	1.33	1.33		1.12	1.30	1.33	
14.5	1.16	1.24	1.24		1.02	1.20	1.24	
15.0	1.07	1.16	1.16		0.93	1.11	1.16	
15.5	1.00	1.09	1.09		0.86	1.02	1.09	
16.0	0.93	1.02	1.02		0.80	0.95	1.02	
16.5	0.87	0.95	0.96		0.74	0.88	0.95	
17.0	0.81	0.90	0.90		0.69	0.82	0.89	
17.5	0.76	0.84	0.85		0.64	0.76	0.83	
18.0	0.71	0.79	0.81		0.60	0.71	0.78	

Generally not limiting design - verify by calculation

Generally not limiting design - verify by calculation

MSS 300/18								
SPAN (m)	INWARDS			Ws kN/m	OUTWARDS			Ws kN/m
	$\phi_b w_u$ kN/m				$\phi_b w_u$ kN/m			
	1B	2B	3B		1B	2B	3B	
3.0								
3.5								
4.0								
4.5								
5.0	9.53	9.53	9.53		9.53	9.53	9.53	
5.5	8.96	8.96	8.96		8.97	8.97	8.97	
6.0	7.95	7.95	7.95		7.95	7.95	7.95	
6.5	7.00	7.00	7.00		7.00	7.00	7.00	
7.0	6.26	6.26	6.26		6.26	6.26	6.26	
7.5	5.63	5.63	5.63		5.63	5.63	5.63	
8.0	4.98	4.98	4.98		4.98	4.98	4.98	
8.5	4.41	4.41	4.41		4.41	4.41	4.41	
9.0	3.93	3.93	3.93		3.93	3.93	3.93	
9.5	3.53	3.53	3.53		3.53	3.53	3.53	
10.0	3.19	3.19	3.19		3.19	3.19	3.19	
10.5	2.89	2.89	2.89		2.89	2.89	2.89	
11.0	2.63	2.63	2.63		2.63	2.63	2.63	
11.5	2.41	2.41	2.41		2.38	2.41	2.41	
12.0	2.21	2.21	2.21		2.15	2.21	2.21	
12.5	2.04	2.04	2.04		1.95	2.04	2.04	
13.0	1.87	1.88	1.88		1.77	1.88	1.88	
13.5	1.71	1.75	1.75		1.61	1.75	1.75	
14.0	1.58	1.62	1.62		1.47	1.63	1.62	
14.5	1.47	1.52	1.52		1.34	1.52	1.52	
15.0	1.36	1.42	1.42		1.23	1.42	1.42	
15.5	1.27	1.33	1.33		1.09	1.32	1.33	
16.0	1.18	1.25	1.25		1.05	1.22	1.25	
16.5	1.10	1.17	1.17		0.98	1.14	1.17	
17.0	1.03	1.10	1.10		0.92	1.06	1.10	
17.5	0.97	1.04	1.04		0.87	0.99	1.04	
18.0	0.91	0.98	0.98		0.82	0.92	0.98	

Generally not limiting design - verify by calculation

Generally not limiting design - verify by calculation

- 1B = One mid span brace
- 2B = Two equally spaced braces within the span
- 3B = Three equally spaced braces within the span
- Ws = Uniformly distributed serviceability load (kN/m) for deflection limit of Span/150
- $\phi_b w_u$ = Strength load resistance applied at the centroid (kN/m)

- 2-M12 Grade 4.6 bolts per connection
- 2-M12 Grade 8.8 bolts per connection
- 2-M16 Grade 4.6 bolts per connection
- 2-M16 Grade 8.8 bolts per connection

IMPORTANT

The adequacy of multispan system is very sensitive to actual applied loads. The stated loads in this table are assumed uniform over the full purlin system. Variations in actual project design loadings over the length of the purlin system must be checked specifically by the designer to verify system adequacy.

MULTISPAN CONTINUOUS (INTERNAL SPANS)

LOAD TABLE – Uniformly Distributed Load

MSS 300/23								
SPAN (m)	INWARDS			Ws kN/m	OUTWARDS			Ws kN/m
	$\phi_b w_u$ kN/m				$\phi_b w_u$ kN/m			
	1B	2B	3B		1B	2B	3B	
3.0								
3.5								
4.0								
4.5								
5.0	12.3	12.3	12.3		12.3	12.3	12.3	
5.5	11.1	11.1	11.1		11.1	11.1	11.1	
6.0	10.2	10.2	10.2		10.2	10.2	10.2	
6.5	9.66	9.66	9.66		9.70	9.70	9.70	
7.0	8.90	8.90	8.90		8.92	8.92	8.92	
7.5	7.99	7.99	7.99		7.99	7.99	7.99	
8.0	7.02	7.02	7.02		7.02	7.02	7.02	
8.5	6.22	6.22	6.22		6.22	6.22	6.22	
9.0	5.55	5.55	5.55		5.55	5.55	5.55	
9.5	4.98	4.98	4.98		4.98	4.98	4.98	
10.0	4.49	4.49	4.49		4.49	4.49	4.49	
10.5	4.08	4.08	4.08		4.08	4.08	4.08	
11.0	3.72	3.72	3.72		3.72	3.72	3.72	
11.5	3.40	3.40	3.40		3.40	3.40	3.40	
12.0	3.12	3.12	3.12		3.12	3.12	3.12	
12.5	2.88	2.88	2.88		2.88	2.88	2.88	
13.0	2.66	2.66	2.66		2.65	2.66	2.66	
13.5	2.47	2.47	2.47		2.40	2.47	2.47	
14.0	2.29	2.29	2.29		2.18	2.29	2.29	
14.5	2.14	2.14	2.14		2.00	2.14	2.14	
15.0	2.00	2.00	2.00		1.86	2.00	2.00	
15.5	1.86	1.87	1.87		1.74	1.87	1.87	
16.0	1.71	1.75	1.75		1.63	1.75	1.75	
16.5	1.59	1.65	1.65		1.53	1.65	1.65	
17.0	1.48	1.56	1.56		1.42	1.56	1.56	
17.5	1.39	1.47	1.47		1.30	1.47	1.47	
18.0	1.30	1.39	1.39		1.20	1.38	1.39	

Generally not limiting design - verify by calculation

Generally not limiting design - verify by calculation

MSS 300/24								
SPAN (m)	INWARDS			Ws kN/m	OUTWARDS			Ws kN/m
	$\phi_b w_u$ kN/m				$\phi_b w_u$ kN/m			
	1B	2B	3B		1B	2B	3B	
3.0								
3.5								
4.0								
4.5								
5.0	13.1	13.1	13.1		13.1	13.1	13.1	
5.5	11.9	11.9	11.8		11.9	11.9	11.8	
6.0	10.9	10.9	10.9		10.9	10.9	10.9	
6.5	10.4	10.4	10.4		10.4	10.4	10.4	
7.0	9.50	9.50	9.50		9.55	9.55	9.55	
7.5	8.75	8.75	8.75		8.75	8.75	8.75	
8.0	7.69	7.69	7.69		7.69	7.69	7.69	
8.5	6.81	6.81	6.81		6.81	6.81	6.81	
9.0	6.07	6.07	6.07		6.07	6.07	6.07	
9.5	5.45	5.45	5.45		5.45	5.45	5.45	
10.0	4.92	4.92	4.92		4.92	4.92	4.92	
10.5	4.46	4.46	4.46		4.46	4.46	4.46	
11.0	4.06	4.06	4.06		4.06	4.06	4.06	
11.5	3.72	3.72	3.72		3.72	3.72	3.72	
12.0	3.42	3.42	3.42		3.42	3.42	3.42	
12.5	3.15	3.15	3.15		3.15	3.15	3.15	
13.0	2.91	2.91	2.91		2.86	2.91	2.91	
13.5	2.70	2.70	2.70		2.59	2.70	2.70	
14.0	2.51	2.51	2.51		2.35	2.51	2.51	
14.5	2.31	2.34	2.34		2.16	2.34	2.34	
15.0	2.12	2.18	2.18		2.01	2.18	2.18	
15.5	1.97	2.05	2.05		1.89	2.05	2.05	
16.0	1.83	1.92	1.92		1.77	1.92	1.92	
16.5	1.70	1.80	1.80		1.65	1.81	1.80	
17.0	1.58	1.70	1.70		1.53	1.70	1.70	
17.5	1.48	1.61	1.61		1.40	1.60	1.61	
18.0	1.38	1.52	1.52		1.29	1.48	1.52	

Generally not limiting design - verify by calculation

Generally not limiting design - verify by calculation

- 1B = One mid span brace
- 2B = Two equally spaced braces within the span
- 3B = Three equally spaced braces within the span
- w_s = Uniformly distributed serviceability load (kN/m) for deflection limit of Span/150
- $\phi_b w_u$ = Strength load resistance applied at the centroid (kN/m)

- 2-M12 Grade 4.6 bolts per connection
- 2-M12 Grade 8.8 bolts per connection
- 2-M16 Grade 4.6 bolts per connection
- 2-M16 Grade 8.8 bolts per connection

IMPORTANT

The adequacy of multispans system is very sensitive to actual applied loads. The stated loads in this table are assumed uniform over the full purlin system. Variations in actual project design loadings over the length of the purlin system must be checked specifically by the designer to verify system adequacy.

MULTISPAN CONTINUOUS (INTERNAL SPANS)

LOAD TABLE – Uniformly Distributed Load

MSS 300/30								
SPAN (m)	INWARDS			Ws kN/m	OUTWARDS			Ws kN/m
	$\phi_b w_u$ kN/m				$\phi_b w_u$ kN/m			
	1B	2B	3B		1B	2B	3B	
3.0								
3.5								
4.0								
4.5								
5.0	16.1	16.1	16.1		16.1	16.1	16.1	
5.5	14.6	14.6	14.6		14.6	14.6	14.6	
6.0	13.4	13.4	13.4		13.4	13.4	13.4	
6.5	12.3	12.4	12.3		12.3	12.4	12.3	
7.0	11.8	11.8	11.8		11.8	11.8	11.8	
7.5	10.9	10.9	10.9		11.0	11.0	11.0	
8.0	10.1	10.1	10.1		10.1	10.1	10.1	
8.5	8.95	8.95	8.95		8.95	8.95	8.95	
9.0	7.98	7.98	7.98		7.98	7.98	7.98	
9.5	7.16	7.16	7.16		7.16	7.16	7.16	
10.0	6.47	6.47	6.47		6.47	6.47	6.47	
10.5	5.86	5.86	5.86		5.86	5.86	5.86	
11.0	5.34	5.34	5.34		5.34	5.34	5.34	
11.5	4.89	4.89	4.89		4.89	4.89	4.89	
12.0	4.49	4.49	4.49		4.48	4.49	4.49	
12.5	4.06	4.14	4.14		4.05	4.14	4.14	
13.0	3.69	3.83	3.83		3.65	3.83	3.83	
13.5	3.37	3.55	3.55		3.30	3.55	3.55	
14.0	3.09	3.30	3.30		3.01	3.30	3.30	
14.5	2.84	3.08	3.08		2.80	3.08	3.08	
15.0	2.62	2.87	2.87		2.61	2.87	2.87	
15.5	2.42	2.69	2.69		2.45	2.69	2.69	
16.0	2.24	2.53	2.53		2.28	2.52	2.53	
16.5	2.08	2.38	2.38		2.10	2.37	2.38	
17.0	1.93	2.23	2.23		1.92	2.20	2.23	
17.5	1.79	2.11	2.11		1.76	2.04	2.11	
18.0	1.67	2.00	2.00		1.62	1.89	2.00	

Generally not limiting design - verify by calculation

Generally not limiting design - verify by calculation

MSS 325/15								
SPAN (m)	INWARDS			Ws kN/m	OUTWARDS			Ws kN/m
	$\phi_b w_u$ kN/m				$\phi_b w_u$ kN/m			
	1B	2B	3B		1B	2B	3B	
3.0								
3.5								
4.0								
4.5								
5.0	7.81	7.81	7.81		7.75	7.75	7.76	
5.5	6.79	6.79	6.79		6.75	6.75	6.75	
6.0	5.96	5.96	5.96		5.93	5.93	5.93	
6.5	5.27	5.27	5.27		5.24	5.24	5.24	
7.0	4.68	4.69	4.68		4.67	4.67	4.67	
7.5	4.20	4.20	4.20		4.18	4.18	4.18	
8.0	3.78	3.78	3.78		3.77	3.77	3.77	
8.5	3.42	3.42	3.41		3.41	3.41	3.41	
9.0	3.10	3.10	3.10		3.10	3.10	3.10	
9.5	2.83	2.83	2.83		2.83	2.83	2.83	
10.0	2.59	2.59	2.59		2.60	2.59	2.59	
10.5	2.38	2.38	2.38		2.45	2.38	2.38	
11.0	2.21	2.19	2.19		2.23	2.20	2.19	
11.5	2.07	2.04	2.04		2.00	2.04	2.04	
12.0	1.88	1.91	1.91		1.81	1.91	1.91	
12.5	1.72	1.78	1.78		1.63	1.78	1.78	
13.0	1.58	1.66	1.66		1.48	1.67	1.67	
13.5	1.46	1.54	1.54		1.34	1.54	1.56	
14.0	1.35	1.43	1.43		1.22	1.41	1.45	
14.5	1.25	1.34	1.34		1.09	1.30	1.35	
15.0	1.16	1.25	1.25		1.01	1.20	1.26	
15.5	1.08	1.17	1.17		0.95	1.11	1.18	
16.0	1.01	1.10	1.10		0.88	1.03	1.11	
16.5	0.94	1.04	1.03		0.82	0.96	1.04	
17.0	0.88	0.97	0.97		0.74	0.89	0.97	
17.5	0.82	0.91	0.92		0.70	0.82	0.90	
18.0	0.77	0.86	0.87		0.65	0.77	0.85	

Generally not limiting design - verify by calculation

Generally not limiting design - verify by calculation

- 1B = One mid span brace
- 2B = Two equally spaced braces within the span
- 3B = Three equally spaced braces within the span
- Ws = Uniformly distributed serviceability load (kN/m) for deflection limit of Span/150
- $\phi_b w_u$ = Strength load resistance applied at the centroid (kN/m)

- 2-M12 Grade 4.6 bolts per connection
- 2-M12 Grade 8.8 bolts per connection
- 2-M16 Grade 4.6 bolts per connection
- 2-M16 Grade 8.8 bolts per connection

IMPORTANT

The adequacy of multispan system is very sensitive to actual applied loads. The stated loads in this table are assumed uniform over the full purlin system. Variations in actual project design loadings over the length of the purlin system must be checked specifically by the designer to verify system adequacy.

MULTISPAN CONTINUOUS (INTERNAL SPANS)

LOAD TABLE – Uniformly Distributed Load

MSS 325/18								
SPAN (m)	INWARDS			Ws kN/m	OUTWARDS			Ws kN/m
	$\phi_b w_u$ kN/m				$\phi_b w_u$ kN/m			
	1B	2B	3B		1B	2B	3B	
3.0								
3.5								
4.0								
4.5								
5.0	9.52	9.52	9.52		9.53	9.52	9.52	
5.5	8.64	8.65	8.62		8.64	8.66	8.63	
6.0	8.19	8.19	8.19		8.21	8.21	8.21	
6.5	7.30	7.30	7.30		7.29	7.29	7.29	
7.0	6.46	6.46	6.46		6.45	6.45	6.45	
7.5	5.84	5.84	5.84		5.83	5.83	5.83	
8.0	5.29	5.29	5.29		5.28	5.28	5.28	
8.5	4.75	4.75	4.75		4.79	4.79	4.79	
9.0	4.23	4.23	4.23		4.27	4.27	4.27	
9.5	3.80	3.80	3.80		3.83	3.83	3.83	
10.0	3.43	3.43	3.43		3.46	3.46	3.46	
10.5	3.11	3.11	3.11		3.14	3.14	3.14	
11.0	2.83	2.83	2.83		2.85	2.86	2.86	
11.5	2.59	2.59	2.59		2.58	2.62	2.62	
12.0	2.38	2.38	2.38		2.33	2.40	2.40	
12.5	2.19	2.20	2.20		2.11	2.21	2.21	
13.0	2.01	2.03	2.03		1.92	2.05	2.05	
13.5	1.84	1.88	1.88		1.75	1.90	1.90	
14.0	1.71	1.75	1.75		1.59	1.76	1.77	
14.5	1.58	1.63	1.63		1.45	1.65	1.65	
15.0	1.47	1.52	1.52		1.33	1.54	1.54	
15.5	1.36	1.43	1.43		1.21	1.43	1.44	
16.0	1.27	1.34	1.34		1.12	1.33	1.35	
16.5	1.19	1.26	1.26		1.06	1.23	1.27	
17.0	1.11	1.19	1.19		0.98	1.15	1.20	
17.5	1.04	1.12	1.12		0.92	1.07	1.13	
18.0	0.98	1.06	1.06		0.87	1.00	1.07	

Generally not limiting design - verify by calculation

Generally not limiting design - verify by calculation

MSS 350/18								
SPAN (m)	INWARDS			Ws kN/m	OUTWARDS			Ws kN/m
	$\phi_b w_u$ kN/m				$\phi_b w_u$ kN/m			
	1B	2B	3B		1B	2B	3B	
3.0								
3.5								
4.0								
4.5								
5.0								
5.5								
6.0	8.06	8.06	8.06		8.01	8.01	8.01	
6.5	7.14	7.14	7.14		7.10	7.10	7.10	
7.0	6.36	6.36	6.36		6.33	6.33	6.33	
7.5	5.70	5.70	5.70		5.68	5.68	5.68	
8.0	5.14	5.14	5.14		5.13	5.13	5.13	
8.5	4.66	4.66	4.66		4.65	4.65	4.65	
9.0	4.24	4.24	4.24		4.23	4.23	4.23	
9.5	3.87	3.87	3.87		3.86	3.86	3.86	
10.0	3.54	3.54	3.54		3.54	3.54	3.54	
10.5	3.26	3.26	3.26		3.26	3.26	3.26	
11.0	3.03	3.03	3.03		3.05	3.03	3.03	
11.5	2.82	2.82	2.82		2.87	2.82	2.82	
12.0	2.63	2.64	2.64		2.61	2.64	2.64	
12.5	2.42	2.45	2.45		2.37	2.47	2.47	
13.0	2.23	2.27	2.27		2.15	2.29	2.29	
13.5	2.05	2.10	2.10		1.95	2.12	2.12	
14.0	1.89	1.96	1.96		1.78	1.97	1.97	
14.5	1.75	1.82	1.82		1.62	1.84	1.84	
15.0	1.62	1.71	1.71		1.48	1.71	1.72	
15.5	1.51	1.60	1.60		1.35	1.59	1.61	
16.0	1.41	1.50	1.50		1.24	1.48	1.51	
16.5	1.32	1.41	1.41		1.17	1.38	1.42	
17.0	1.23	1.33	1.33		1.08	1.28	1.34	
17.5	1.15	1.25	1.25		1.01	1.20	1.26	
18.0	1.08	1.18	1.18		0.95	1.12	1.19	

Generally not limiting design - verify by calculation

Generally not limiting design - verify by calculation

- 1B = One mid span brace
- 2B = Two equally spaced braces within the span
- 3B = Three equally spaced braces within the span
- w_s = Uniformly distributed serviceability load (kN/m) for deflection limit of Span/150
- $\phi_b w_u$ = Strength load resistance applied at the centroid (kN/m)

- 2-M12 Grade 4.6 bolts per connection
- 2-M12 Grade 8.8 bolts per connection
- 2-M16 Grade 4.6 bolts per connection
- 2-M16 Grade 8.8 bolts per connection

IMPORTANT

The adequacy of multispan system is very sensitive to actual applied loads. The stated loads in this table are assumed uniform over the full purlin system. Variations in actual project design loadings over the length of the purlin system must be checked specifically by the designer to verify system adequacy.

MULTISPAN CONTINUOUS (INTERNAL SPANS)

LOAD TABLE – Uniformly Distributed Load

MSS 350/23								
SPAN (m)	INWARDS			Ws kN/m	OUTWARDS			Ws kN/m
	$\phi_b w_u$ kN/m				$\phi_b w_u$ kN/m			
	1B	2B	3B		1B	2B	3B	
3.0								
3.5								
4.0								
4.5								
5.0								
5.5								
6.0	10.2	10.2	10.2		10.2	10.2	10.2	
6.5	9.39	9.41	9.38		9.41	9.42	9.39	
7.0	8.74	8.74	8.74		8.75	8.74	8.74	
7.5	8.37	8.38	8.36		8.37	8.38	8.37	
8.0	7.85	7.85	7.85		7.87	7.87	7.87	
8.5	7.34	7.34	7.34		7.35	7.35	7.35	
9.0	6.69	6.69	6.69		6.75	6.75	6.75	
9.5	6.01	6.01	6.01		6.06	6.06	6.06	
10.0	5.42	5.42	5.42		5.46	5.46	5.46	
10.5	4.92	4.92	4.92		4.96	4.96	4.96	
11.0	4.48	4.48	4.48		4.52	4.52	4.52	
11.5	4.10	4.10	4.10		4.14	4.13	4.13	
12.0	3.76	3.76	3.76		3.80	3.80	3.80	
12.5	3.47	3.47	3.47		3.50	3.50	3.50	
13.0	3.21	3.21	3.21		3.19	3.23	3.23	
13.5	2.97	2.97	2.97		2.91	3.00	3.00	
14.0	2.76	2.77	2.77		2.65	2.79	2.79	
14.5	2.55	2.58	2.58		2.42	2.60	2.60	
15.0	2.35	2.41	2.41		2.23	2.43	2.43	
15.5	2.18	2.26	2.26		2.07	2.27	2.27	
16.0	2.03	2.12	2.12		1.93	2.14	2.14	
16.5	1.90	1.99	1.99		1.81	2.01	2.01	
17.0	1.77	1.88	1.88		1.70	1.89	1.89	
17.5	1.66	1.77	1.77		1.60	1.78	1.78	
18.0	1.56	1.67	1.67		1.48	1.66	1.69	

MSS 350/24								
SPAN (m)	INWARDS			Ws kN/m	OUTWARDS			Ws kN/m
	$\phi_b w_u$ kN/m				$\phi_b w_u$ kN/m			
	1B	2B	3B		1B	2B	3B	
3.0								
3.5								
4.0								
4.5								
5.0								
5.5								
6.0	10.9	10.9	10.9		10.9	10.9	10.9	
6.5	10.0	10.0	10.0		10.0	10.1	10.0	
7.0	9.32	9.32	9.32		9.33	9.32	9.32	
7.5	8.69	8.70	8.67		8.70	8.70	8.69	
8.0	8.43	8.43	8.43		8.42	8.42	8.42	
8.5	7.83	7.82	7.83		7.86	7.86	7.86	
9.0	7.31	7.31	7.31		7.37	7.37	7.37	
9.5	6.56	6.56	6.56		6.61	6.61	6.61	
10.0	5.92	5.92	5.92		5.97	5.97	5.97	
10.5	5.37	5.37	5.37		5.42	5.42	5.42	
11.0	4.89	4.89	4.89		4.94	4.94	4.94	
11.5	4.48	4.48	4.48		4.51	4.52	4.52	
12.0	4.11	4.11	4.11		4.15	4.15	4.15	
12.5	3.79	3.79	3.79		3.82	3.82	3.82	
13.0	3.50	3.50	3.50		3.53	3.53	3.53	
13.5	3.25	3.25	3.25		3.23	3.27	3.27	
14.0	3.02	3.02	3.02		2.95	3.04	3.04	
14.5	2.81	2.82	2.82		2.70	2.84	2.84	
15.0	2.61	2.63	2.63		2.50	2.65	2.65	
15.5	2.41	2.46	2.46		2.33	2.48	2.48	
16.0	2.24	2.31	2.31		2.18	2.33	2.33	
16.5	2.09	2.18	2.18		2.04	2.19	2.19	
17.0	1.95	2.05	2.05		1.91	2.07	2.07	
17.5	1.83	1.93	1.93		1.77	1.95	1.95	
18.0	1.72	1.83	1.83		1.63	1.84	1.84	

- 1B = One mid span brace
- 2B = Two equally spaced braces within the span
- 3B = Three equally spaced braces within the span
- Ws = Uniformly distributed serviceability load (kN/m) for deflection limit of Span/150
- $\phi_b w_u$ = Strength load resistance applied at the centroid (kN/m)

- 2-M12 Grade 4.6 bolts per connection
- 2-M12 Grade 8.8 bolts per connection
- 2-M16 Grade 4.6 bolts per connection
- 2-M16 Grade 8.8 bolts per connection

IMPORTANT

The adequacy of multispan system is very sensitive to actual applied loads. The stated loads in this table are assumed uniform over the full purlin system. Variations in actual project design loadings over the length of the purlin system must be checked specifically by the designer to verify system adequacy.

MULTISPAN CONTINUOUS (INTERNAL SPANS)

LOAD TABLE – Uniformly Distributed Load

MSS 350/30								
SPAN (m)	INWARDS			Ws kN/m	OUTWARDS			Ws kN/m
	$\phi_b w_u$ kN/m				$\phi_b w_u$ kN/m			
	1B	2B	3B		1B	2B	3B	
3.0								
3.5								
4.0								
4.5								
5.0								
5.5								
6.0	13.4	13.4	13.4		13.4	13.4	13.4	
6.5	12.3	12.3	12.3		12.3	12.3	12.3	
7.0	11.5	11.5	11.5		11.5	11.5	11.5	
7.5	10.7	10.7	10.7		10.7	10.7	10.7	
8.0	10.0	10.0	10.0		10.0	10.0	10.0	
8.5	9.74	9.75	9.74		9.76	9.76	9.76	
9.0	9.09	9.09	9.09		9.14	9.14	9.14	
9.5	8.61	8.61	8.61		8.60	8.60	8.60	
10.0	7.81	7.81	7.81		7.88	7.88	7.88	
10.5	7.09	7.09	7.09		7.15	7.15	7.15	
11.0	6.46	6.46	6.46		6.51	6.51	6.51	
11.5	5.91	5.91	5.91		5.96	5.96	5.96	
12.0	5.43	5.43	5.43		5.48	5.47	5.47	
12.5	4.99	5.00	5.00		5.05	5.04	5.04	
13.0	4.59	4.62	4.62		4.61	4.66	4.66	
13.5	4.13	4.29	4.29		4.17	4.32	4.32	
14.0	3.78	3.99	3.99		3.81	4.02	4.02	
14.5	3.47	3.72	3.72		3.51	3.75	3.75	
15.0	3.20	3.47	3.47		3.27	3.50	3.50	
15.5	2.95	3.25	3.25		3.07	3.28	3.28	
16.0	2.73	3.05	3.05		2.87	3.08	3.08	
16.5	2.53	2.87	2.87		2.65	2.90	2.90	
17.0	2.35	2.70	2.70		2.44	2.73	2.73	
17.5	2.19	2.55	2.55		2.24	2.57	2.57	
18.0	2.04	2.41	2.41		2.06	2.39	2.43	

MSS 400/20								
SPAN (m)	INWARDS			Ws kN/m	OUTWARDS			Ws kN/m
	$\phi_b w_u$ kN/m				$\phi_b w_u$ kN/m			
	1B	2B	3B		1B	2B	3B	
3.0								
3.5								
4.0								
4.5								
5.0								
5.5								
6.0	8.83	8.83	8.84		8.85	8.85	8.85	
6.5	8.31	8.31	8.30		8.26	8.26	8.26	
7.0	7.49	7.49	7.49		7.44	7.44	7.44	
7.5	6.78	6.78	6.78		6.74	6.74	6.74	
8.0	6.16	6.16	6.16		6.12	6.12	6.12	
8.5	5.62	5.62	5.62		5.59	5.59	5.59	
9.0	5.15	5.15	5.15		5.13	5.13	5.13	
9.5	4.74	4.74	4.74		4.72	4.72	4.71	
10.0	4.37	4.37	4.37		4.35	4.35	4.35	
10.5	4.04	4.04	4.04		4.03	4.02	4.03	
11.0	3.75	3.75	3.75		3.74	3.74	3.74	
11.5	3.48	3.48	3.49		3.48	3.47	3.48	
12.0	3.25	3.25	3.25		3.25	3.24	3.24	
12.5	3.03	3.03	3.03		3.11	3.03	3.03	
13.0	2.86	2.84	2.84		2.94	2.84	2.84	
13.5	2.72	2.67	2.67		2.68	2.67	2.67	
14.0	2.53	2.52	2.52		2.45	2.52	2.52	
14.5	2.34	2.39	2.39		2.25	2.39	2.39	
15.0	2.18	2.27	2.27		2.06	2.27	2.27	
15.5	2.02	2.15	2.15		1.88	2.16	2.15	
16.0	1.89	2.03	2.03		1.72	2.02	2.04	
16.5	1.76	1.91	1.91		1.61	1.88	1.92	
17.0	1.65	1.80	1.80		1.50	1.75	1.81	
17.5	1.55	1.70	1.70		1.39	1.64	1.71	
18.0	1.45	1.60	1.60		1.30	1.53	1.62	

1B = One mid span brace
 2B = Two equally spaced braces within the span
 3B = Three equally spaced braces within the span
 w_s = Uniformly distributed serviceability load (kN/m) for deflection limit of Span/150
 $\phi_b w_u$ = Strength load resistance applied at the centroid (kN/m)

- 2-M12 Grade 4.6 bolts per connection
- 2-M12 Grade 8.8 bolts per connection
- 2-M16 Grade 4.6 bolts per connection
- 2-M16 Grade 8.8 bolts per connection

IMPORTANT

The adequacy of multispan system is very sensitive to actual applied loads. The stated loads in this table are assumed uniform over the full purlin system. Variations in actual project design loadings over the length of the purlin system must be checked specifically by the designer to verify system adequacy.

MULTISPAN CONTINUOUS (INTERNAL SPANS)

LOAD TABLE – Uniformly Distributed Load

MSS 400/23								
SPAN (m)	INWARDS			Ws kN/m	OUTWARDS			Ws kN/m
	$\phi_b w_u$ kN/m				$\phi_b w_u$ kN/m			
	1B	2B	3B		1B	2B	3B	
3.0								
3.5								
4.0								
4.5								
5.0								
5.5								
6.0	10.2	10.2	10.2		10.2	10.2	10.2	
6.5	9.40	9.41	9.38		9.41	9.43	9.39	
7.0	8.74	8.74	8.74		8.75	8.74	8.74	
7.5	8.14	8.16	8.14		8.16	8.16	8.15	
8.0	7.65	7.65	7.65		7.65	7.65	7.65	
8.5	7.46	7.46	7.46		7.46	7.46	7.46	
9.0	6.92	6.92	6.92		6.89	6.89	6.89	
9.5	6.35	6.35	6.35		6.33	6.32	6.32	
10.0	5.88	5.88	5.88		5.86	5.86	5.86	
10.5	5.48	5.48	5.49		5.47	5.47	5.47	
11.0	5.13	5.13	5.13		5.12	5.12	5.12	
11.5	4.77	4.77	4.77		4.79	4.79	4.79	
12.0	4.39	4.39	4.39		4.43	4.43	4.43	
12.5	4.05	4.05	4.05		4.08	4.08	4.08	
13.0	3.74	3.74	3.74		3.72	3.78	3.78	
13.5	3.46	3.47	3.47		3.39	3.50	3.50	
14.0	3.17	3.23	3.23		3.09	3.26	3.26	
14.5	2.92	3.01	3.01		2.82	3.03	3.03	
15.0	2.71	2.81	2.81		2.58	2.84	2.84	
15.5	2.51	2.63	2.63		2.36	2.66	2.66	
16.0	2.34	2.47	2.47		2.19	2.49	2.49	
16.5	2.18	2.32	2.32		2.05	2.34	2.34	
17.0	2.03	2.19	2.19		1.93	2.21	2.21	
17.5	1.90	2.06	2.06		1.83	2.07	2.08	
18.0	1.78	1.95	1.95		1.72	1.94	1.97	

MSS 400/24								
SPAN (m)	INWARDS			Ws kN/m	OUTWARDS			Ws kN/m
	$\phi_b w_u$ kN/m				$\phi_b w_u$ kN/m			
	1B	2B	3B		1B	2B	3B	
3.0								
3.5								
4.0								
4.5								
5.0								
5.5								
6.0	10.9	10.9	10.9		10.9	10.9	10.9	
6.5	10.0	10.0	10.0		10.0	10.0	10.0	
7.0	9.32	9.32	9.32		9.33	9.32	9.32	
7.5	8.69	8.70	8.68		8.70	8.71	8.69	
8.0	8.16	8.16	8.16		8.16	8.16	8.17	
8.5	7.66	7.68	7.66		7.68	7.68	7.66	
9.0	7.48	7.48	7.48		7.49	7.49	7.49	
9.5	7.05	7.05	7.05		7.08	7.08	7.08	
10.0	6.65	6.65	6.65		6.68	6.68	6.68	
10.5	6.27	6.27	6.27		6.32	6.32	6.32	
11.0	5.71	5.71	5.71		5.76	5.76	5.76	
11.5	5.23	5.23	5.23		5.27	5.27	5.27	
12.0	4.80	4.80	4.80		4.84	4.84	4.84	
12.5	4.42	4.42	4.42		4.46	4.46	4.46	
13.0	4.09	4.09	4.09		4.12	4.12	4.12	
13.5	3.79	3.79	3.79		3.75	3.82	3.82	
14.0	3.51	3.53	3.53		3.42	3.56	3.56	
14.5	3.21	3.29	3.29		3.12	3.31	3.31	
15.0	2.97	3.07	3.07		2.86	3.10	3.10	
15.5	2.76	2.88	2.88		2.65	2.90	2.90	
16.0	2.57	2.70	2.70		2.48	2.72	2.72	
16.5	2.39	2.54	2.54		2.32	2.56	2.56	
17.0	2.23	2.39	2.39		2.19	2.41	2.41	
17.5	2.09	2.26	2.26		2.05	2.28	2.28	
18.0	1.95	2.13	2.13		1.91	2.14	2.15	

- 1B = One mid span brace
- 2B = Two equally spaced braces within the span
- 3B = Three equally spaced braces within the span
- w_s = Uniformly distributed serviceability load (kN/m) for deflection limit of Span/150
- $\phi_b w_u$ = Strength load resistance applied at the centroid (kN/m)

- 2-M12 Grade 4.6 bolts per connection
- 2-M12 Grade 8.8 bolts per connection
- 2-M16 Grade 4.6 bolts per connection
- 2-M16 Grade 8.8 bolts per connection

IMPORTANT

The adequacy of multispan system is very sensitive to actual applied loads. The stated loads in this table are assumed uniform over the full purlin system. Variations in actual project design loadings over the length of the purlin system must be checked specifically by the designer to verify system adequacy.

MULTISPAN CONTINUOUS (INTERNAL SPANS)

LOAD TABLE – Uniformly Distributed Load

MSS 400/30									
SPAN (m)	INWARDS			W _s kN/m	OUTWARDS			W _s kN/m	
	φ _b W _u kN/m				φ _b W _u kN/m				
	1B	2B	3B		1B	2B	3B		
3.0				Generally not limiting design - verify by calculation				Generally not limiting design - verify by calculation	
3.5									
4.0									
4.5									
5.0									
5.5									
6.0	13.4	13.4	13.4			13.4	13.4		13.4
6.5	12.3	12.3	12.3			12.3	12.3		12.3
7.0	11.5	11.5	11.5			11.5	11.5		11.5
7.5	10.7	10.7	10.7			10.7	10.7		10.7
8.0	10.0	10.0	10.0			10.0	10.0		10.0
8.5	9.42	9.44	9.42			9.44	9.45		9.42
9.0	8.91	8.91	8.91			8.92	8.92		8.92
9.5	8.50	8.51	8.49			8.51	8.52		8.50
10.0	8.29	8.29	8.29			8.29	8.29		8.29
10.5	7.80	7.80	7.80			7.84	7.84		7.84
11.0	7.43	7.43	7.43			7.44	7.44		7.44
11.5	6.92	6.92	6.92			6.98	6.98		6.98
12.0	6.36	6.36	6.36		6.41	6.41	6.41		
12.5	5.86	5.86	5.86		5.91	5.91	5.91		
13.0	5.42	5.42	5.42		5.46	5.46	5.46		
13.5	5.01	5.02	5.02		5.06	5.07	5.07		
14.0	4.63	4.67	4.67		4.61	4.71	4.71		
14.5	4.18	4.35	4.35		4.28	4.39	4.39		
15.0	3.84	4.07	4.07		3.97	4.10	4.10		
15.5	3.54	3.81	3.81		3.67	3.84	3.84		
16.0	3.27	3.58	3.58		3.40	3.61	3.61		
16.5	3.03	3.36	3.36		3.16	3.39	3.39		
17.0	2.81	3.17	3.17		2.95	3.20	3.20		
17.5	2.62	2.99	2.99		2.71	3.02	3.02		
18.0	2.44	2.83	2.83		2.51	2.85	2.85		

- 1B = One mid span brace
- 2B = Two equally spaced braces within the span
- 3B = Three equally spaced braces within the span
- W_s = Uniformly distributed serviceability load (kN/m) for deflection limit of Span/150
- φ_bW_u = Strength load resistance applied at the centroid (kN/m)

- 2-M12 Grade 4.6 bolts per connection
- 2-M12 Grade 8.8 bolts per connection
- 2-M16 Grade 4.6 bolts per connection
- 2-M16 Grade 8.8 bolts per connection

IMPORTANT

The adequacy of multispan system is very sensitive to actual applied loads. The stated loads in this table are assumed uniform over the full purlin system. Variations in actual project design loadings over the length of the purlin system must be checked specifically by the designer to verify system adequacy.



BRACING

CONTENTS

MSS Purlin Hole Details	164
Lapped MSS Purlins	165
Bracing Systems	166
Camlock™ Bracing Components	168
Standard Bracing Systems	170
General Purpose Brackets	173
Continuous Span MSS Purlins Splice Joint	174

MSS PURLIN HOLE DETAILS

FOR CAMLOK™ BRACING

Slotted holes

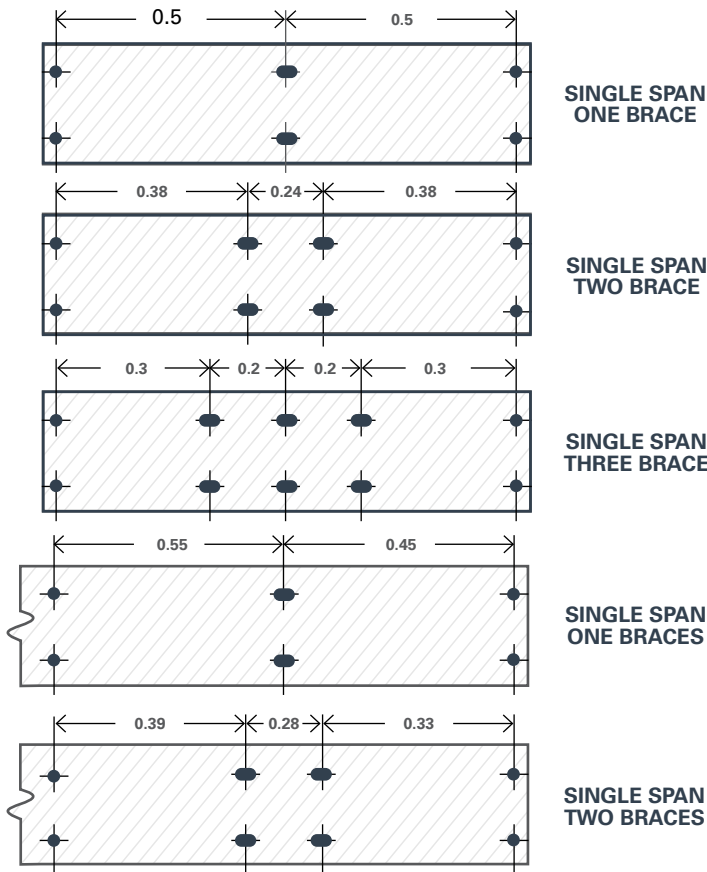

FOR STANDARD BRACING

Round holes

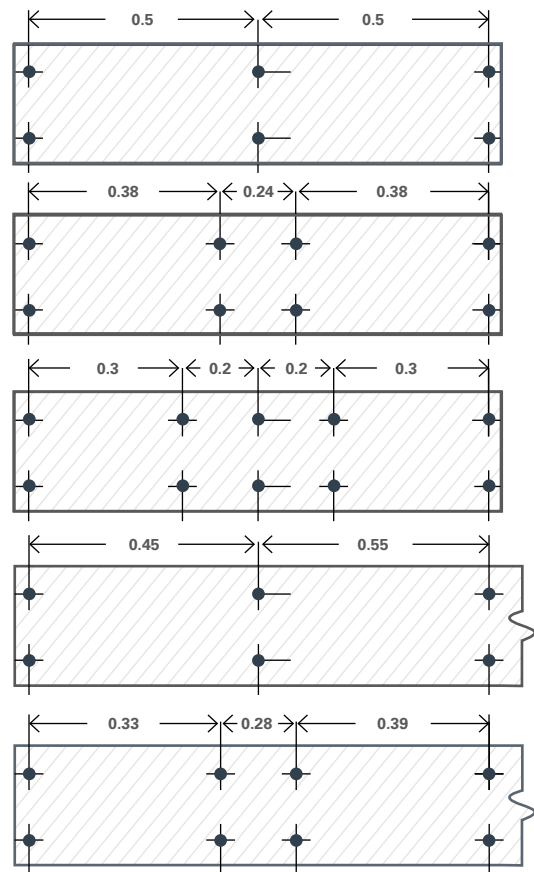

PURLIN BRACING HOLE SIZES AND CENTRES

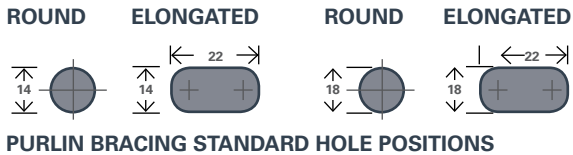

HOLE CENTERS	
D	W
150	80
200	120
250	160
275	180
300	200
325	220
350	240
400	280

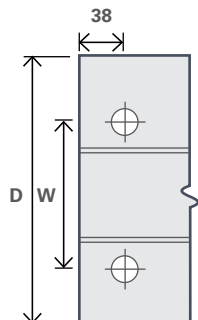

PORTAL CLEAT RECOMMENDATIONS

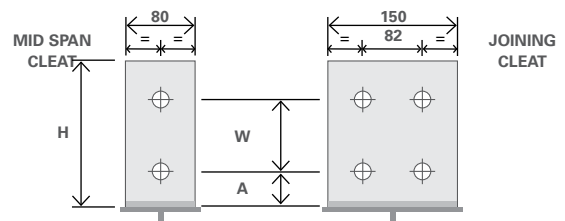

PURLINS	A	W	H
150	41	80	150
200	46	120	200
250	53	160	250
275	54	180	275
300	60	200	300
325	59	220	320
350	65	240	340
400	70	280	380

LAPPED MSS PURLINS

WITH SINGLE BRACING AND BOLTING PROCEDURE

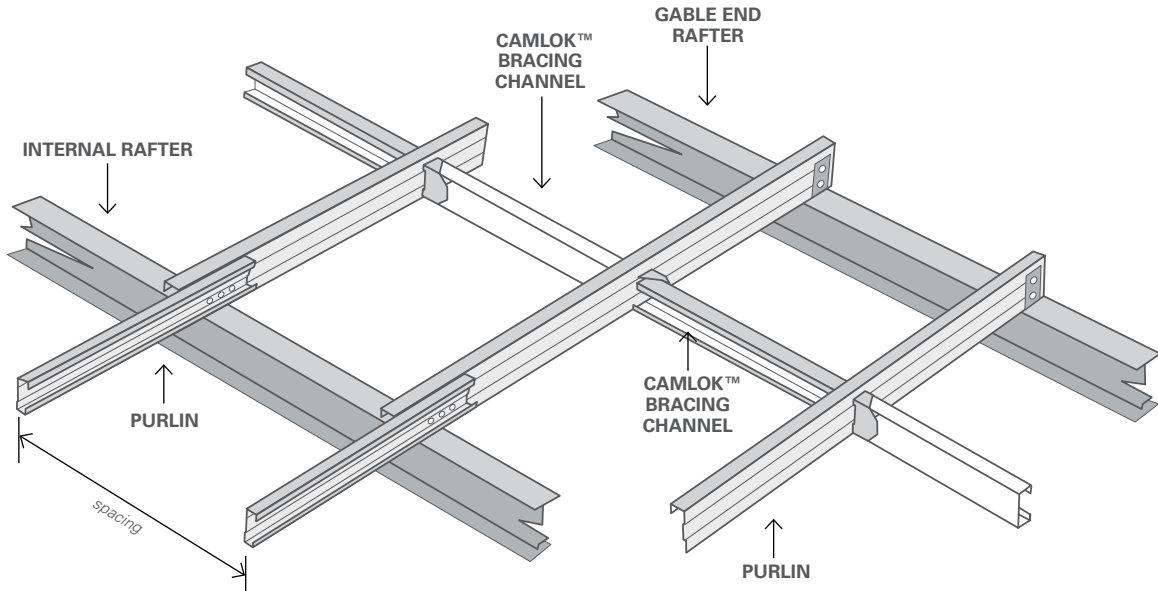

CAMLOK™ BRACING OR STANDARD



DOUBLE LAPPED PURLINS – END SPAN

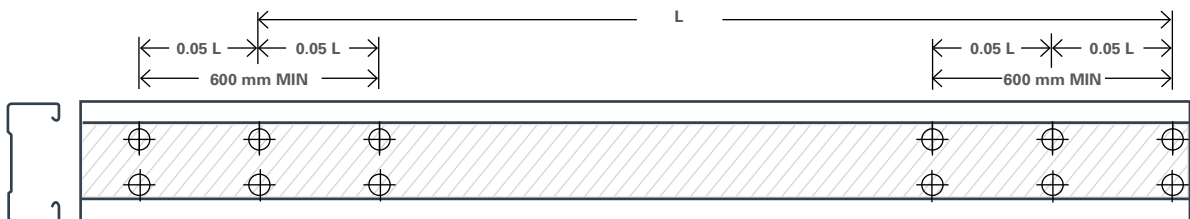

LAPPED PURLINS – INTERNAL SPAN

Hole positions for intermediate braces as for the single span purlins

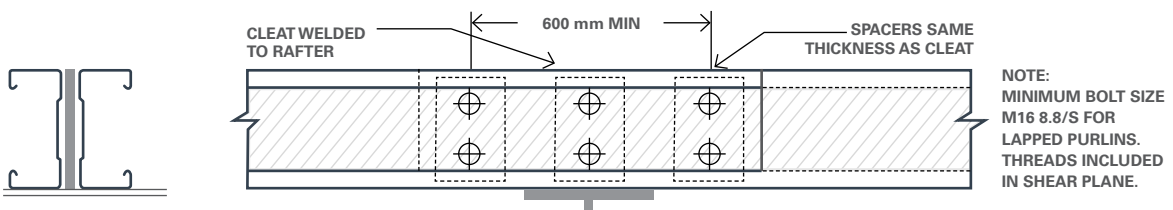

BRACING SYSTEMS

Metalcraft has two bracing systems, Camlock™ and Standard. All Purlins and Girts should be braced to maximise the design limit of the component. It is recommended that at least one row of bracing be used on any span, particularly if temporary loads may be experienced during construction. If the bracing is required to support super imposed dead loads (eg. lighting, sprinklers) specific design will be required.

Camlock™ is a bracing system that has no sag rods to place and no bolts or washers to fix. This has proven to save up to 75% of time in Bracing installation, giving considerable cost advantages.

Metalcraft MSS Purlin and Girt system has been designed for bolting to cleats using the tables provided for hole and cleat dimensions. M12 or M16 Class 4.6 bolts and washers must be used. Design Engineers should give consideration to the bolt diameter, washer size and cleat material and thickness to be used also considering the reaction caused by double or continuous spans and high loads. The bracing systems are formed from galvanised Grade 250 steel.

CAMLOK™ BRACING SYSTEM UPTO AND INCLUDING MSS 325

Section drawing

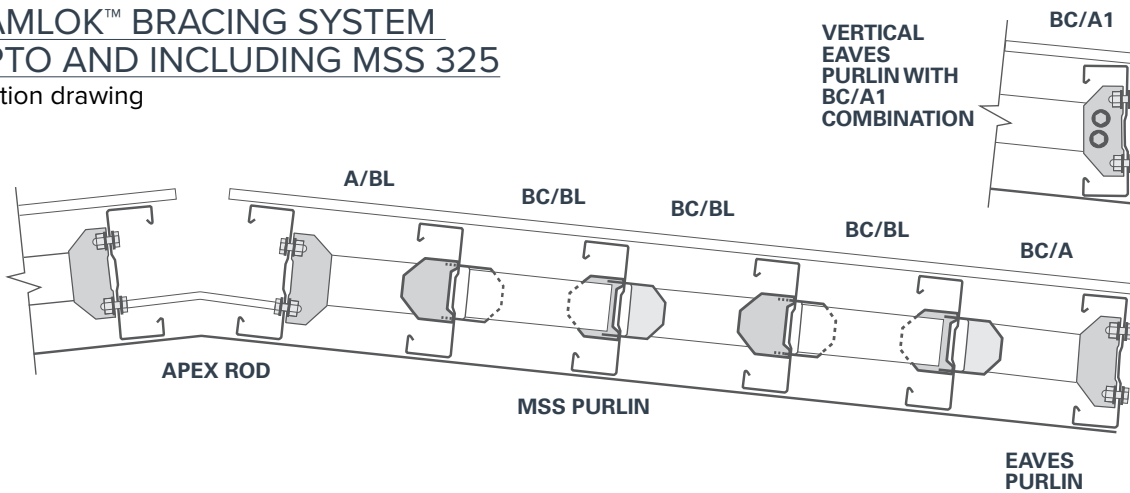

ALTERNATIVE CAMLOK™ BRACING SYSTEM WITH NO APEX ROD.

Section drawing

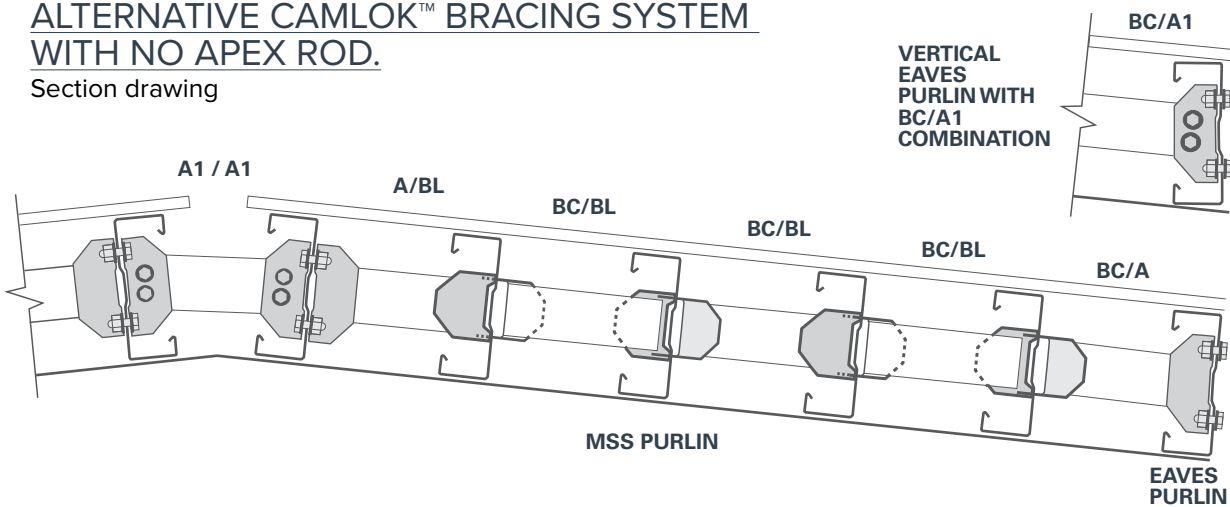

BRACING SYSTEMS

CAMLOK™ ASSEMBLY DETAIL

Section drawing

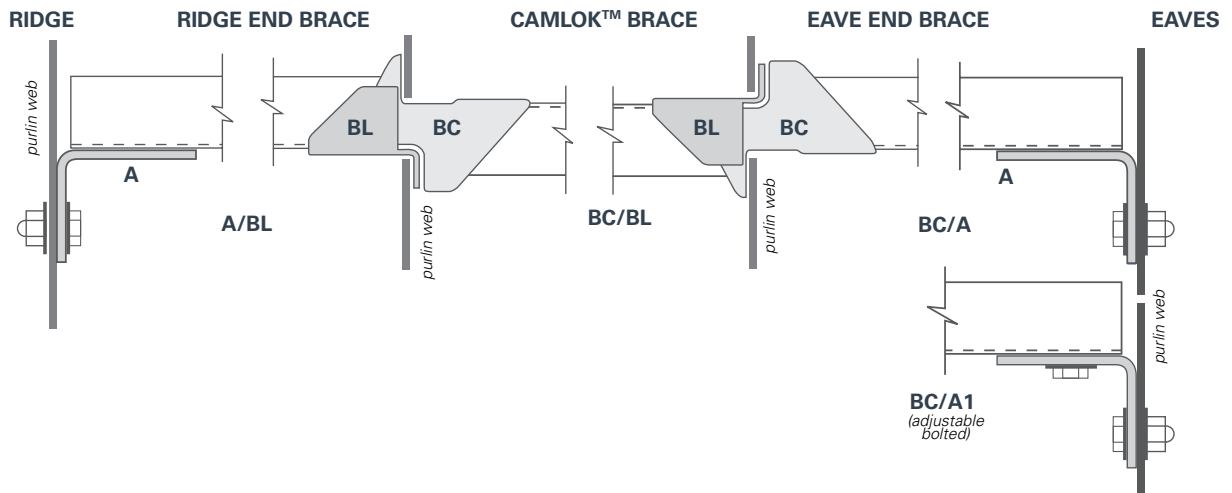

CAMLOK™ BRACING COMPONENTS

Camlok™ is not available for MSS 350, MSS 375 and MSS 400
Standard bracing must be used for these sizes.

STANDARD CAMLOK™ CLAMP BRACKET

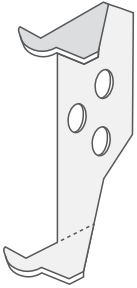

P/NO. BC

ADJUSTABLE CLAMP BRACKET

Can be used in midspan



P/NO. BC1

STANDARD CAMLOK™ LOCATOR BRACKET

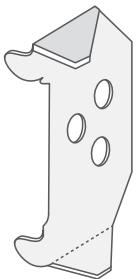

P/NO. BL

ADJUSTABLE LOCATOR BRACKET

Can be used in midspan



P/NO. BL1

STANDARD BRACING BRACKET

Used when bolted connection preferred ie. to PFC supports or concrete walls

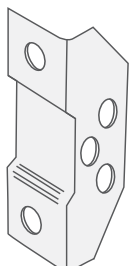

P/NO. A

ADJUSTABLE BRACING BRACKET

Generally used in fascia or girt length adjustment of ± 10 mm or angular of $\pm 10^\circ$

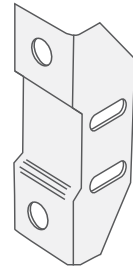

P/NO. A1

CAMLOK™ BRACING COMPONENTS

Camlok™ is not available for MSS 350, MSS 375 and MSS 400 Standard bracing must be used for these sizes.

CAMLOK™ ASSEMBLY

End bracket to suit purlin size

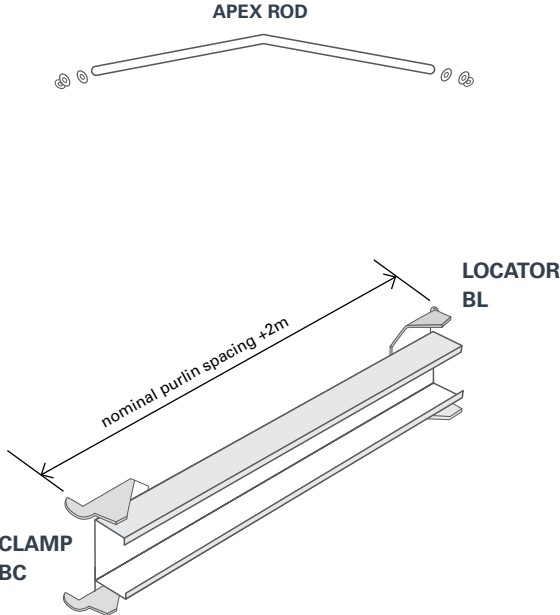

CAMLOK™ ADJUSTABLE ASSEMBLY

Mid span adjustment

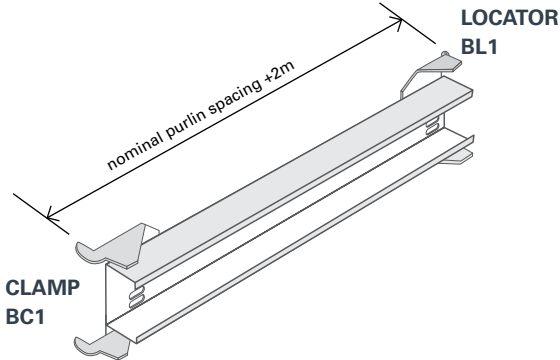

STANDARD BRACING SYSTEMS

STANDARD BRACING SYSTEM

Section drawing

Standard Bracing and Sag Rod's are fitted to alternate bays with the channel located adjacent to both the ridge and eave purlin. Sag Rod's are available in either 12dia or 16dia and are provided Zinc or Hot Dip Galvanized. They should be installed in the lower pre-punched fixing hole.

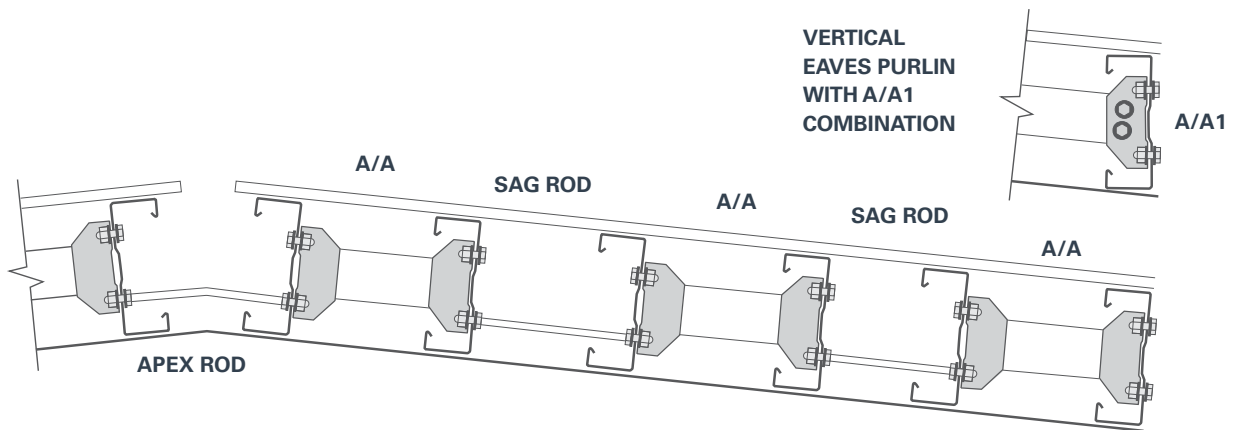

STANDARD BRACING SYSTEM WITH NO SAG RODS OR APEX ROD (MSS 150 TO MSS 400)

Section drawing

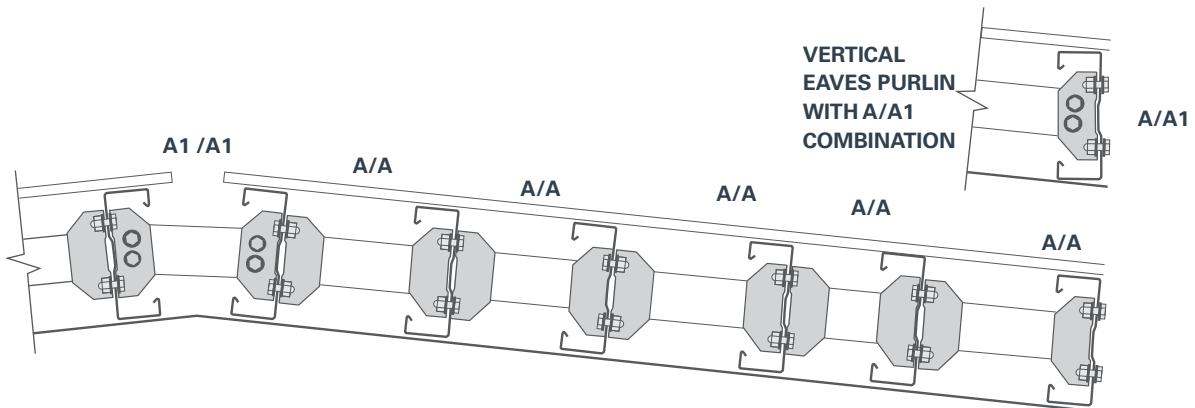

STANDARD BRACING COMPONENTS

STANDARD BRACING COMPONENTS

APEX

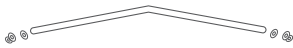

SAG ROD

2 nuts and 2 washers each

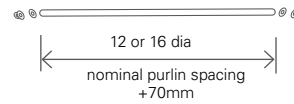

STANDARD BRACING BRACKET

Used when bolted connection preferred ie. to PFC supports or concrete walls

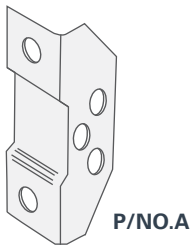

ADJUSTABLE STANDARD BRACKET

Generally used in fascia or girt length adjustment of ± 10 mm or angular of $\pm 10^\circ$ can be used midspan

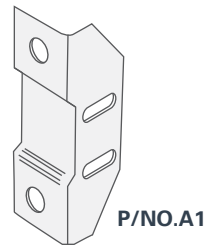

ADJUSTABLE STANDARD BRACING

End bracket to suit purlin size

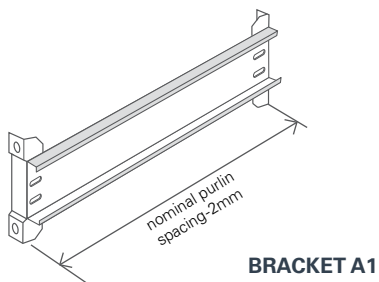
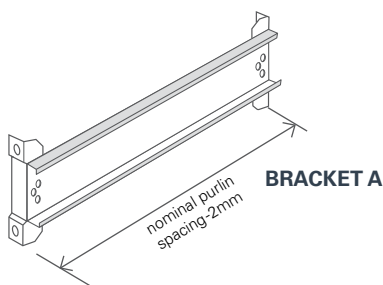

STANDARD BRACING SYSTEMS

STANDARD BRACING SYSTEMS

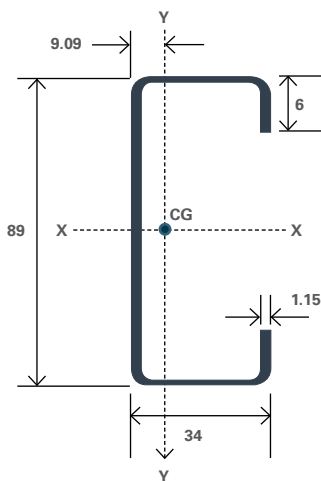

BRACE CHANNEL PROPERTIES

Tabulated section properties are based on full unreduced sections

Mass kg/m	Weight kN/m	Area mm ²	I _{xx} 10 ⁶ mm ⁴	I _{yy} 10 ⁶ mm ⁴	Z _{xx} 10 ³ mm ³	Column Properties	
						J mm ⁴	I _w 10 ⁹ mm ⁶
1.44	0.014	184	0.22	0.02	4.99	81.0	0.04

BRACE CHANNEL

BRACE CHANNEL SELECTION

for MSS Purlin spacings up to 3.0m

Maximum DESIGN LINEAR LOAD CAPACITY occurring on Purlin (kN/m). $\phi_b w_u$

PURLINS	1 Brace	2 Braces	3 Braces
150	7.6		
200	4.6	9.1	
250	3.1	6.1	9.1
275	2.5	5.0	7.5
300	2.1	4.2	6.2
325	2.0	3.9	5.8
350	2.0	3.7	5.5
400	*	3.3	4.6

* NOT RECOMMENDED

Brace specifications outside the brace channel selection guidelines will require specific design.

GENERAL PURPOSE BRACKETS

GENERAL PURPOSE BRACKETS

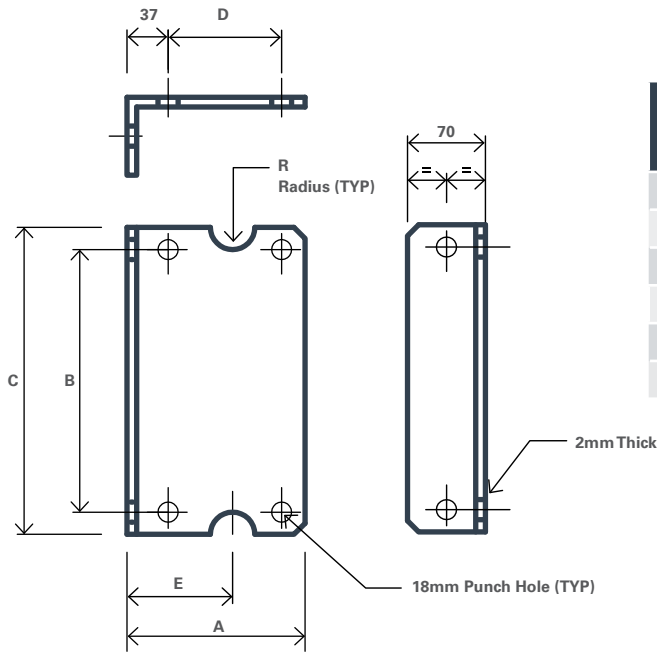

Size	A	B	C	D	E	Radius
150	130	80	115	65	60	15
200	130	120	155	75	60	15
250	150	160	195	85	80	15
300	150	200	250	95	80	15
350	160	240	276	100	88	15
400	160	280	316	105	88	15

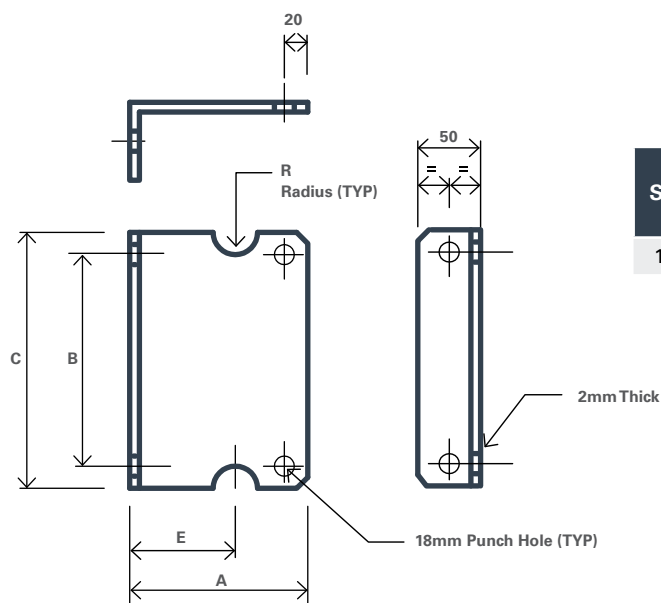

Size	A	B	C	D	E	Radius
100	108	40	80	-	45	15

CONTINUOUS SPAN MSS PURLINS SPLICE JOINT

SPLICE JOINT CAPACITY

DESIGN MOMENT AND SHEAR AT POINT OF SPLICE LOCATION SHALL BE LESS THAN FIGURES IN TABLE BELOW:

CODE	ϕM kNm	$\phi_v V_v$ kN
MSS 150/12	3.0	5.8
MSS 150/15	4.1	11.0
MSS 150/18	3.9	17.8
MSS 150/23	4.1	23.5
MSS 200/12	4.3	4.3
MSS 200/15	5.7	8.1
MSS 200/18	5.7	13.7
MSS 200/23	5.5	23.4
MSS 250/13	6.8	5.2
MSS 250/15	8.3	7.7
MSS 250/18	8.7	12.3
MSS 250/23	8.5	22.2
MSS 275/15	8.3	7.5
MSS 275/18	10.6	12.5
MSS 300/15	10.1	6.2
MSS 300/18	13.1	10.4
MSS 300/23	18.2	19.2
MSS 300/24	18.5	23.7
MSS 300/30	19.2	44.0
MSS 325/15	10.3	5.4
MSS 325/18	13.2	9.0
MSS 350/18	15.8	8.7
MSS 350/23	20.9	19.8
MSS 350/24	22.7	19.8
MSS 350/30	32.6	38.7
MSS 400/20	21.5	10.1
MSS 400/23	25.1	16.0
MSS 400/24	24.9	17.0
MSS 400/30	38.5	33.3

NOTES:

1. The design engineer shall endeavour to position the splice in a location with zero moment demand.
2. The above design capacities are for the continuous purlin bolted splice, constructed and installed strictly in accordance with the MSS Purlin splice joint details.
3. Axial load shall be considered separately by the design engineer.

CONTINUOUS SPAN MSS PURLINS SPLICE JOINT

SPLICE JOINT HOLE POSITIONS MSS150, MSS 200 & MSS 250

Specific design is required where axial load applies.

SPLICE PLATE
BOLTED TO PURLINS

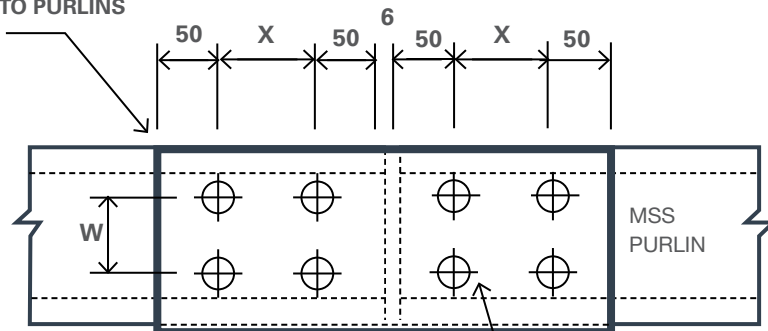

HOLE POSITIONS

MSS PURLIN	W (mm)	X (mm)
MSS 150	80	120
MSS 200	120	120
MSS 250	160	180

M16 GRADE 4.6 WITH WASHERS POSITIONED UNDER BOLT HEAD AND NUT.

SPLICE JOINT HOLE POSITIONS MSS 275, MSS 300, MSS 325, MSS 350 & MSS 400

Specific design is required where axial load applies.

SPLICE PLATE
BOLTED TO PURLINS

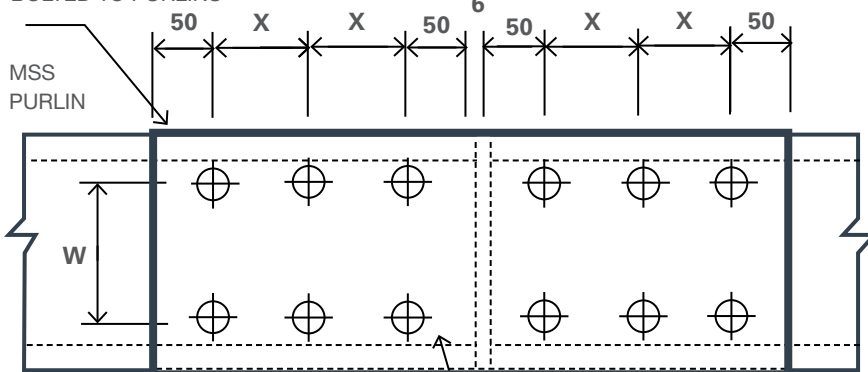

HOLE POSITIONS

MSS PURLIN	W (mm)	X (mm)
MSS 275	180	120
MSS 300	200	120
MSS 325	220	120
MSS 350	240	120
MSS 400	280	120

M16 GRADE 4.6

TO BE USED FOR MSS - BMT 1.15, 1.25, 1.45, 1.75 AND 1.95MM. WITH WASHERS POSITIONED UNDER BOLT HEAD AND NUT.

M16 GRADE 8.8

TO BE USED FOR MSS - BMT 2.25, 2.4 AND 3.0MM. WITH WASHERS POSITIONED UNDER BOLT HEAD AND NUT.

CONTINUOUS SPAN MSS PURLINS SPLICE JOINT

MSS 150

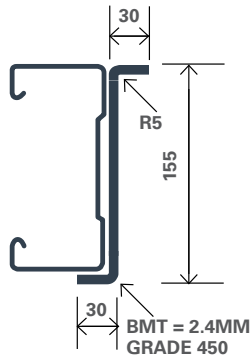

MSS 200

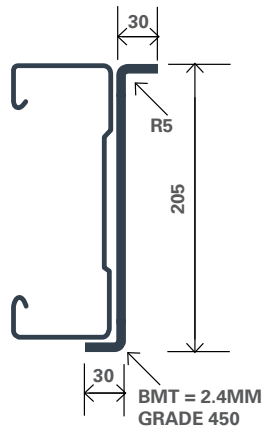

MSS 250

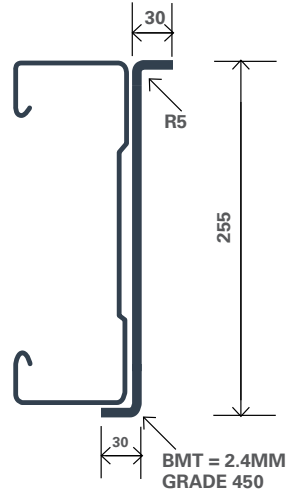

MSS 275

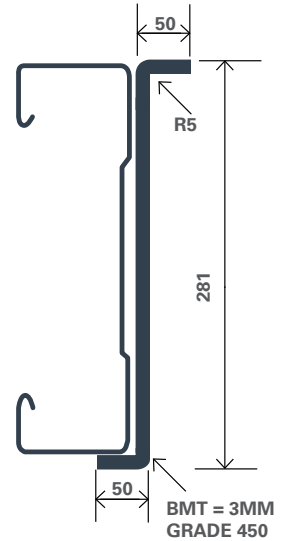

MSS 300

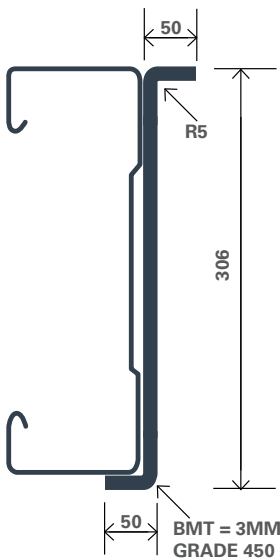

MSS 325

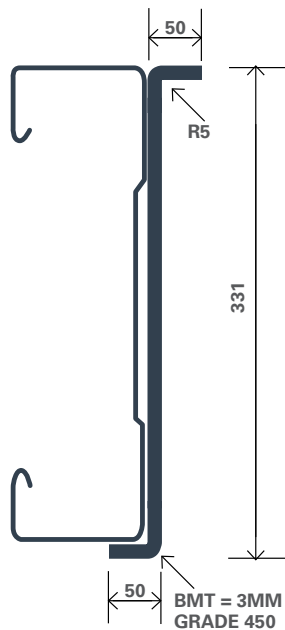

MSS 350

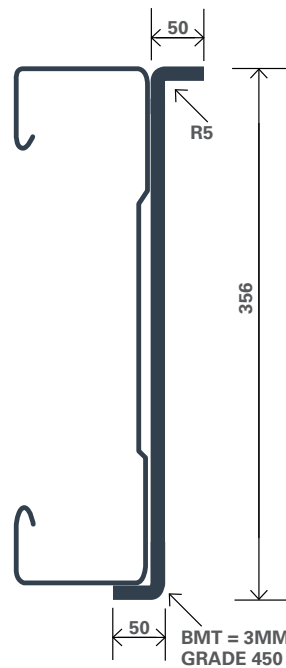

MSS 400

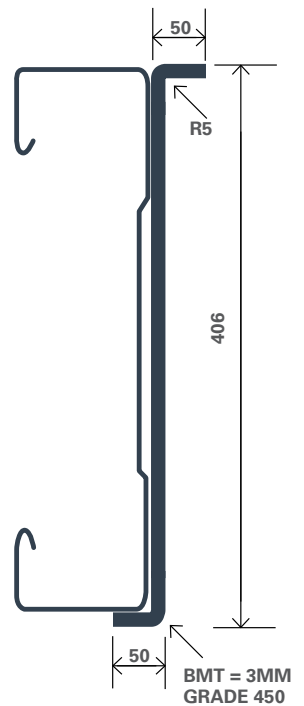

BOLT JOINT CAPACITIES

SPLICE PLATE CONNECTION - BOLT JOINT CAPACITY

Splice plate connection is to be made using M16 bolts as per splice specification

MSS PURLIN BMT (mm)	M16		M16 BOLT SHEAR	
	BEARING (kN)	TEAROUT (kN)	BEARING (kN)	TEAROUT (kN)
1.15	15.0	13.6	28.6	59.3
1.25	17.0	14.8	28.6	59.3
1.45	21.0	17.2	28.6	59.3
1.75	24.2	19.2	28.6	59.3
1.95	27.0	21.3	28.6	59.3
2.25	28.6	24.6	28.6	59.3
2.4	33.2	26.3	28.6	59.3
3.0	66.4	49.3	28.6	59.3

NOTES:

1. The above capacities are for one bolt, loaded in shear only.
2. Bearing capacity is based on washers both sides.
3. Tearout is calculated for an edge distance of 38mm.
4. Rupture shall be considered separately by the design engineer.
5. Capacities are calculated to AS/NZS 4600:2005 for gauges less than 3.0mm
6. Capacities are calculated to NZS 3404:1997 for 3.0mm gauge.
7. Splice plate connection is to be made using M16 bolts as per splice specification
8. No ductility was taken into account for the above capacities
9. The design engineer shall satisfy himself that the bolt / bolt group is adequate.

SPECIFIC DESIGN - BOLT JOINT CAPACITY

Not to be used for Splice plate connection this is to be made using M16 bolts as per splice specification. Refer table above.

MSS PURLIN BMT (mm)	M12		M12 BOLT SHEAR	
	BEARING (kN)	TEAROUT (kN)	BEARING (kN)	TEAROUT (kN)
1.15	12.7	13.6	15.1	31.4
1.25	14.0	14.8	15.1	31.4
1.45	16.3	17.2	15.1	31.4
1.75	18.1	19.2	15.1	31.4
1.95	20.2	21.3	15.1	31.4
2.25	23.3	24.6	15.1	31.4
2.4	24.9	26.3	15.1	31.4
3.0	49.8	49.3	15.1	31.4

NOTES:

1. The above capacities are for one bolt, loaded in shear only.
2. Bearing capacity is based on washers both sides.
3. Tearout is calculated for an edge distance of 38mm.
4. Rupture shall be considered separately by the design engineer.
5. Capacities are calculated to AS/NZS 4600:2005 for gauges less than 3.0mm
6. Capacities are calculated to NZS 3404:1997 for 3.0mm gauge.
7. Splice plate connection is to be made using M16 bolts as per splice specification. Refer to table above.
8. No ductility was taken into account for the above capacities
9. The design engineer shall satisfy himself that the bolt / bolt group is adequate.

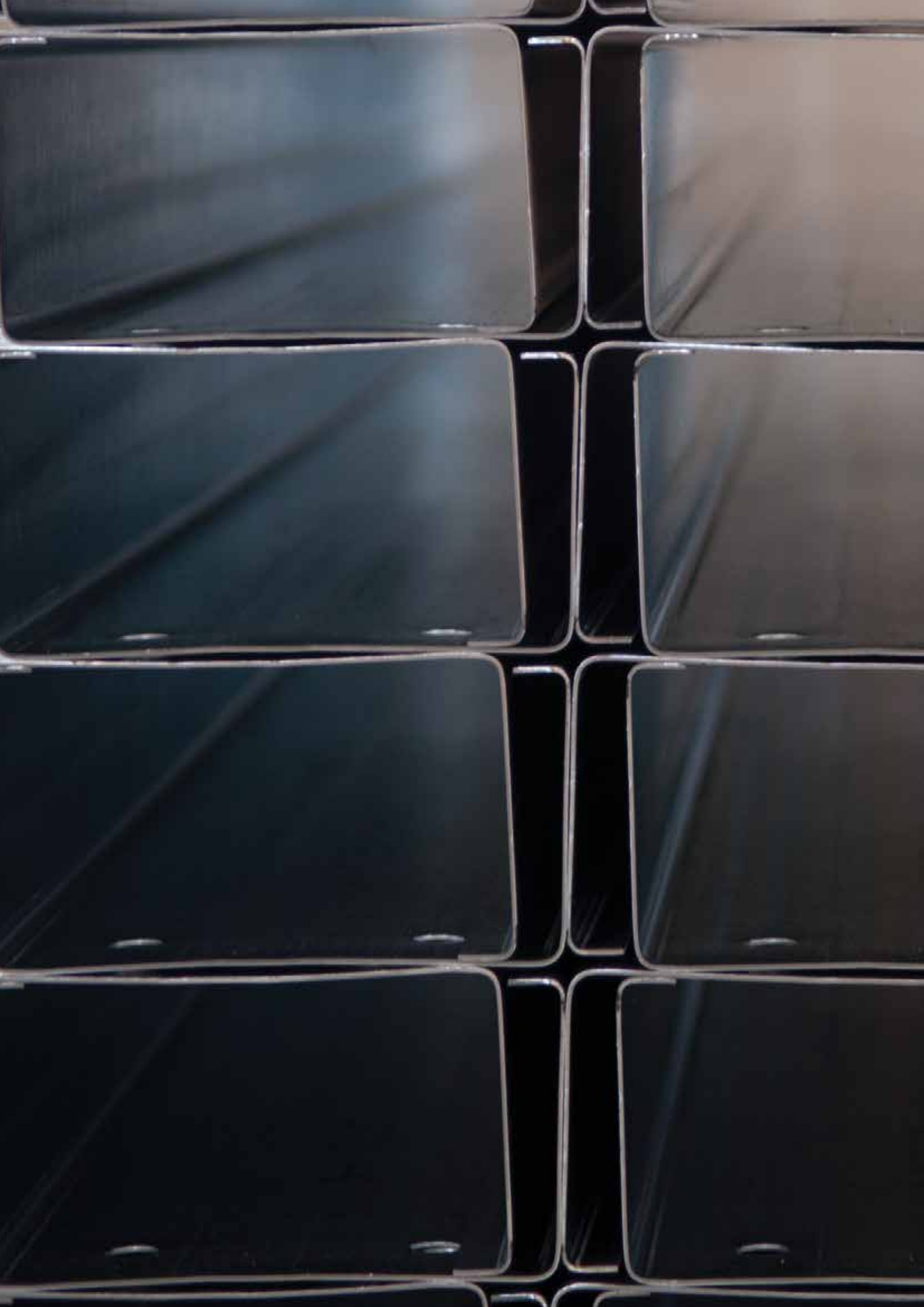

MC PURLINS

CONTENTS

MC Section Geometry	180
MC Section Properties	181
MC Purlins Span Guide	182
Single Span (Inwards Load)	183

MC SECTION GEOMETRY

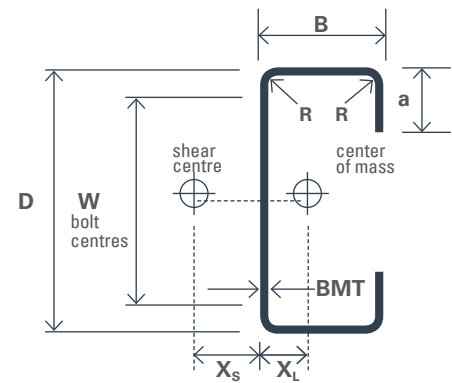

CODE	D x B mm	BMT mm	Mass kg/m	Area mm ²	a mm	R mm	X _S mm	X _L mm	W mm
MC 100/10	100 x 50	0.95	1.70	216.10	14	4	23.8	16.8	N/A
MC 100/12	100 x 50	1.15	2.03	258.10	14	4	23.5	16.8	N/A
MC 100/16	100 x 50	1.55	2.68	341.10	14	4	23.0	16.8	N/A
MC 100/19	100 x 50	1.85	3.08	392.10	14	4	22.7	16.8	N/A
MC 150/12	150 x 65	1.15	2.70	344.30	16	4	29.0	19.9	80
MC 150/15	150 x 65	1.45	3.39	432.00	16	4	28.7	19.9	80
MC 150/19	150 x 65	1.85	4.30	547.50	16	4	28.2	19.9	80
MC 150/24	150 x 65	2.4	5.52	703.80	16	4	27.5	19.9	80
MC 200/15	200 x 75	1.45	4.35	553.80	23	4	33.9	22.7	120
MC 200/19	200 x 75	1.85	5.52	702.90	23	4	33.4	22.7	120
MC 200/24	200 x 75	2.4	7.11	905.40	23	4	32.7	22.7	120
MC 250/15	250 x 85	1.45	5.10	649.50	21	4	35.4	23.1	160
MC 250/19	250 x 85	1.85	6.48	825.00	21	4	35.0	23.1	160
MC 250/24	250 x 85	2.4	8.35	1064.00	21	4	34.3	23.1	160
MC 300/24(90)	300 x 90	2.4	9.48	1208.00	21	4	34.5	22.6	200
MC 300/24(100)	300 x 100	2.4	9.86	1256.00	21	4	39.2	25.9	200
MC 300/30(90)	300 x 90	2.95	11.78	1501.00	21	4	33.8	22.6	200
MC 300/30(100)	300 x 100	2.95	12.25	1561.00	21	4	38.5	26.0	200
MC 400/24	400 x 100	2.4	12.05	1535.00	30	5	38.5	24.1	280
MC 400/30	400 x 100	2.95	14.99	1910.00	30	5	37.8	24.1	280

MC SECTION PROPERTIES

CODE	Area mm ²	Second Moment Of Area (x10 ⁹ mm ⁴)		Section Modulus (x10 ³ mm ³)		Warping Factor (x10 ⁹ mm ⁶)	Bending Stress MPa		Compression Stress MPa		β_y (x10 ⁶ mm ⁴)
		I _x	I _y	Z _x	Z _y	I _w	FOL	FOD	FOL	FOD	
MC 100/10	216.1	0.35	0.076	7.1	2.3	0.164	401.5	370.7	106.6	216.6	121.00
MC 100/12	258.1	0.42	0.090	8.4	2.8	0.193	570.9	454.9	153.4	266.1	120.60
MC 100/16	341.1	0.55	0.116	11.1	3.6	0.246	1005.0	626.5	273.4	369.1	119.80
MC 100/19	392.1	0.62	0.132	12.7	4.1	0.277	1341.0	741.9	366.2	440.5	119.40
MC 150/12	344.3	1.24	0.196	16.6	4.4	0.884	278.9	266.2	61.9	145.4	170.20
MC 150/15	432.0	1.54	0.243	20.8	5.5	1.089	441.1	347.9	98.6	188.4	169.80
MC 150/19	547.5	1.94	0.303	26.2	6.9	1.346	715.4	455.4	161.0	250.4	169.20
MC 150/24	703.8	2.47	0.380	33.5	8.7	1.670	1197.0	617.6	271.7	349.1	168.30
MC 200/15	553.8	3.43	0.434	34.6	8.4	3.603	280.0	321.7	55.8	150.7	216.00
MC 200/19	702.9	4.33	0.543	43.7	10.6	4.482	456.0	423.0	91.1	198.2	215.50
MC 200/24	905.4	5.54	0.687	56.1	13.4	5.614	768.8	567.0	153.8	367.8	215.50
MC 250/15	649.5	6.18	0.606	49.7	9.9	7.359	185.8	220.2	35.7	91.9	269.60
MC 250/19	825.0	7.81	0.760	63.0	12.5	9.181	302.5	290.0	58.3	120.7	269.20
MC 250/24	1064.0	10.01	0.963	80.8	15.9	11.550	508.8	392.5	98.3	163.9	268.80
MC 300/24(90)	1208.0	15.93	1.169	107.0	17.6	19.890	365.4	318.9	68.4	150.2	325.90
MC 300/24(100)	1256.0	16.99	1.518	114.2	20.8	25.630	353.8	279.8	67.7	118.4	325.40
MC 300/30(90)	1501.0	19.67	1.424	132.5	21.6	24.100	569.3	418.6	106.6	185.0	325.90
MC 100/30(100)	1561.0	20.99	1.854	141.4	25.6	31.110	550.7	365.4	105.8	165.2	325.00
MC 400/24	1535.0	34.75	1.875	174.8	25.1	58.590	213.9	285.8	39.1	75.8	442.90
MC 400/30	1910.0	43.03	2.294	216.8	30.8	71.380	334.7	370.7	61.0	102.5	443.40

MC PURLINS SPAN GUIDE

CODE	D x B mm	BMT mm	Mass kg/m	Span (m)														
				4	5	6	7	8	9	10	11	12	13	14	15	16	17	18
MC100/10	100 x 50	0.95	1.70	█														
MC100/12	100 x 50	1.15	2.03	█														
MC100/16	100 x 50	1.55	2.68	█														
MC100/19	100 x 50	1.85	3.08	█														
MC150/12	100 x 65	1.15	2.70	█	█													
MC150/15	100 x 65	1.45	3.39	█	█	█												
MC150/19	100 x 65	1.85	4.30	█	█	█	█											
MC150/24	100 x 65	2.4	5.52	█	█	█	█	█										
MC200/15	200 x 75	1.45	4.35	█	█	█	█	█										
MC200/19	200 x 75	1.85	5.52	█	█	█	█	█	█									
MC200/24	200 x 75	2.4	7.11	█	█	█	█	█	█	█								
MC250/15	250 x 85	1.45	5.10	█	█	█	█	█	█									
MC250/19	250 x 85	1.85	6.48	█	█	█	█	█	█	█								
MC250/24	250 x 85	2.4	8.35	█	█	█	█	█	█	█	█							
MC300/24(90)	300 x 90	2.4	9.48	█	█	█	█	█	█	█	█	█						
MC300/24(100)	300 x 100	2.4	9.86	█	█	█	█	█	█	█	█	█	█					
MC300/30(90)	300 x 90	2.95	11.78	█	█	█	█	█	█	█	█	█	█	█				
MC300/30(100)	300 x 100	2.95	12.25	█	█	█	█	█	█	█	█	█	█	█	█			
MC400/24	400 x 100	2.4	12.05	█	█	█	█	█	█	█	█	█	█	█	█	█		
MC400/30	400 x 100	2.95	14.99	█	█	█	█	█	█	█	█	█	█	█	█	█	█	

NOTE: This chart is for quick reference only. Each situation should be considered separately and designed using standard procedures.
FOR FURTHER INFORMATION AND ORDERS CONTACT METALCRAFT ROOFING

This chart is based on simple single span conditions with criteria determined by:

$$W_{b_s} = 1.0 \text{ kN/m}$$

$$W_{s_s} = 0.5 \text{ kN/m for span/150 deflection limit}$$

Purlin spacing and wind zone will impact purlin selection. This table is approximately equivalent to medium wind zone with single span purlins at 1.2m c/c with light roof only.

SINGLE SPAN (INWARDS LOAD)

LOAD TABLE – Uniformly Distributed Load

	MC 100/10					MC 100/12					MC 100/16					MC 100/19					
Span (m)	ϕ_{bW_u} kN/m				ws kN/m	ϕ_{bW_u} kN/m				ws kN/m	ϕ_{bW_u} kN/m				ws kN/m	ϕ_{bW_u} kN/m				ws kN/m	Span (m)
	0	1B	2B	3B		0	1B	2B	3B		0	1B	2B	3B		0	1B	2B	3B		
2.0	4.41	4.41	4.41	4.40	4.17	5.66	5.66	5.66	5.66	5.00	7.37	7.72	7.72	7.72	6.73						2.0
2.5	2.82	2.82	2.82	2.82	2.13	3.62	3.62	3.62	3.62	2.56	4.64	4.94	4.94	4.94	3.45						2.5
3.0	1.96	1.96	1.96	1.96	1.24	2.49	2.51	2.51	2.51	1.48	3.19	3.43	3.43	3.43	1.99	3.74	4.13	4.13	4.13	2.32	3.0
3.5	1.44	1.44	1.44	1.44	0.78	1.82	1.85	1.85	1.85	0.93	2.32	2.52	2.52	2.52	1.26	2.71	3.04	3.04	3.04	1.46	3.5
4.0	1.10	1.10	1.10	1.10	0.52	1.38	1.41	1.41	1.41	0.63	1.76	1.93	1.93	1.93	0.84	2.06	2.33	2.33	2.33	0.98	4.0
4.5	0.87	0.87	0.87	0.87	0.37	1.08	1.12	1.12	1.12	0.44	1.39	1.53	1.53	1.53	0.59	1.61	1.83	1.84	1.84	0.69	4.5
5.0	0.71	0.71	0.71	0.71	0.27	0.87	0.91	0.91	0.91	0.32	1.12	1.24	1.24	1.24	0.43	1.30	1.48	1.49	1.49	0.50	5.0
5.5	0.58	0.58	0.58	0.58	0.20	0.72	0.75	0.75	0.75	0.24	0.92	1.02	1.02	1.02	0.32	1.06	1.22	1.23	1.23	0.38	5.5
6.0	0.49	0.49	0.49	0.49	0.15	0.60	0.63	0.63	0.63	0.19	0.77	0.85	0.86	0.86	0.25	0.89	1.02	1.03	1.03	0.29	6.0
6.5	0.42	0.42	0.42	0.42	0.12	0.51	0.54	0.54	0.54	0.15	0.62	0.73	0.73	0.73	0.20	0.75	0.87	0.88	0.88	0.23	6.5
7.0	0.36	0.36	0.36	0.36	0.10	0.44	0.46	0.46	0.46	0.12	0.56	0.62	0.63	0.63	0.16	0.65	0.74	0.76	0.76	0.18	7.0
7.5	0.30	0.30	0.30	0.31	0.08	0.38	0.40	0.40	0.40	0.095	0.49	0.54	0.55	0.55	0.13	0.56	0.65	0.66	0.66	0.15	7.5
8.0	0.28	0.28	0.28	0.28	0.07	0.33	0.35	0.35	0.35	0.08	0.43	0.47	0.48	0.48	0.11	0.49	0.57	0.58	0.58	0.12	8.0
8.5	0.24	0.24	0.24	0.24	0.05	0.29	0.31	0.31	0.31	0.07	0.38	0.42	0.43	0.43	0.09	0.43	0.50	0.51	0.51	0.10	8.5
9.0	0.22	0.22	0.22	0.22	0.05	0.26	0.28	0.28	0.28	0.05	0.36	0.38	0.37	0.38	0.07	0.39	0.45	0.46	0.46	0.09	9.0
9.5						0.24	0.25	0.25	0.25	0.05	0.30	0.36	0.34	0.34	0.06	0.35	0.40	0.41	0.41	0.07	9.5
10.0																0.31	0.36	0.37	0.37	0.06	10.0
10.5																0.28	0.33	0.33	0.34	0.05	10.5
11.0																					11.0
11.5																					11.5
12.0																					12.0
12.5																					12.5
13.0																					13.0
13.5																					13.5
14.0																					14.0
14.5																					14.5
15.0																					15.0
15.5																					15.5
16.0																					16.0
16.5																					16.5
17.0																					17.0
17.5																					17.5
18.0																					18.0
ϕ_{M_s} kNm	2.60					3.19					4.11					4.96					ϕ_{M_s} kNm
$\phi_v V_v$ kN	9.67					16.78					32.33					42.35					$\phi_v V_v$ kN

- 0B = No braces
- 1B = One mid span brace
- 2B = Two equally spaced braces within the span
- 3B = Three equally spaced braces within the span
- ws = Uniformly distributed serviceability load (kN/m) for deflection limit of Span/150
- ϕ_{bW_u} = Strength load resistance applied at the

- 2-M12 Grade 4.6 bolts per connection
- 2-M12 Grade 8.8 bolts per connection
- 2-M16 Grade 4.6 bolts per connection
- 2-M16 Grade 8.8 bolts per connection

SINGLE SPAN (INWARDS LOAD)

LOAD TABLE – Uniformly Distributed Load

Span (m)	MC 150/12					MC 150/15					MC 150/19					MC 150/24					Span (m)
	$\phi_b W_u$ kN/m				w_s kN/m	$\phi_b W_u$ kN/m				w_s kN/m	$\phi_b W_u$ kN/m				w_s kN/m	$\phi_b W_u$ kN/m				w_s kN/m	
	0	1B	2B	3B		0	1B	2B	3B		0	1B	2B	3B		0	1B	2B	3B		
2.0																					2.0
2.5																					2.5
3.0	4.04	4.04	4.04	4.04	4.19	5.57	5.60	5.60	5.60	5.43	6.69	7.30	7.30	7.30	6.97	8.87	10.3	10.3	10.3	9.10	3.0
3.5	2.97	2.97	2.97	2.97	2.64	4.02	4.12	4.12	4.12	3.42	4.81	5.36	5.36	5.36	4.39	6.30	7.58	7.58	7.58	5.73	3.5
4.0	2.27	2.27	2.27	2.27	1.77	3.03	3.15	3.15	3.15	2.29	3.62	4.11	4.11	4.11	2.94	4.69	5.80	5.80	5.80	3.84	4.0
4.5	1.79	1.79	1.79	1.79	1.24	2.36	2.49	2.49	2.49	1.61	2.82	3.24	3.24	3.24	2.07	3.62	4.59	4.59	4.59	2.70	4.5
5.0	1.45	1.45	1.45	1.45	0.90	1.89	2.02	2.02	2.02	1.17	2.26	2.63	2.63	2.63	1.51	2.88	3.68	3.71	3.71	1.97	5.0
5.5	1.19	1.20	1.20	1.20	0.68	1.55	1.67	1.67	1.67	0.88	1.85	2.17	2.17	2.17	1.13	2.34	3.01	3.07	3.07	1.48	5.5
6.0	1.00	1.01	1.01	1.01	0.52	1.29	1.40	1.40	1.40	0.68	1.54	1.83	1.83	1.83	0.87	1.94	2.51	2.58	2.58	1.14	6.0
6.5	0.85	0.86	0.86	0.86	0.41	1.09	1.19	1.19	1.19	0.53	1.30	1.56	1.56	1.56	0.69	1.63	2.12	2.20	2.20	0.89	6.5
7.0	0.73	0.74	0.74	0.74	0.33	0.93	1.03	1.03	1.03	0.43	1.11	1.34	1.34	1.34	0.55	1.39	1.82	1.90	1.90	0.72	7.0
7.5	0.63	0.65	0.65	0.65	0.27	0.81	0.90	0.90	0.90	0.35	0.96	1.17	1.17	1.17	0.45	1.20	1.57	1.65	1.65	0.58	7.5
8.0	0.55	0.57	0.57	0.57	0.22	0.70	0.79	0.79	0.79	0.29	0.84	1.02	1.03	1.03	0.37	1.04	1.38	1.45	1.45	0.48	8.0
8.5	0.49	0.50	0.50	0.50	0.18	0.62	0.70	0.70	0.70	0.24	0.74	0.90	0.91	0.91	0.31	0.92	1.21	1.27	1.29	0.40	8.5
9.0	0.43	0.45	0.45	0.45	0.16	0.55	0.62	0.62	0.62	0.20	0.66	0.80	0.81	0.81	0.26	0.81	1.08	1.13	1.15	0.37	9.0
9.5	0.39	0.40	0.40	0.40	0.13	0.49	0.56	0.56	0.56	0.17	0.59	0.72	0.73	0.73	0.22	0.72	0.96	1.01	1.03	0.29	9.5
10.0	0.35	0.36	0.36	0.36	0.11	0.44	0.50	0.50	0.50	0.15	0.53	0.64	0.66	0.66	0.19	0.65	0.87	0.91	0.91	0.25	10.0
10.5	0.32	0.33	0.33	0.33	0.10	0.40	0.46	0.46	0.46	0.13	0.48	0.58	0.60	0.60	0.16	0.58	0.78	0.82	0.84	0.21	10.5
11.0	0.29	0.30	0.30	0.30	0.085	0.36	0.42	0.42	0.42	0.11	0.43	0.53	0.54	0.54	0.14	0.53	0.71	0.74	0.76	0.18	11.0
11.5	0.26	0.27	0.27	0.27	0.07	0.33	0.38	0.38	0.38	0.10	0.39	0.48	0.50	0.50	0.12	0.48	0.65	0.68	0.70	0.16	11.5
12.0						0.30	0.35	0.35	0.35	0.08	0.36	0.44	0.46	0.46	0.11	0.44	0.59	0.62	0.64	0.14	12.0
12.5																					12.5
13.0																					13.0
13.5																					13.5
14.0																					14.0
14.5																					14.5
15.0																					15.0
15.5																					15.5
16.0																					16.0
16.5																					16.5
17.0																					17.0
17.5																					17.5
18.0																					18.0
ϕM_s kNm	5.30					7.61					9.23					12.75					ϕM_s kNm
$\phi_v V_v$ kN	9.47					19.06					39.83					72.74					$\phi_v V_v$ kN

- 0B = No braces
- 1B = One mid span brace
- 2B = Two equally spaced braces within the span
- 3B = Three equally spaced braces within the span
- w_s = Uniformly distributed serviceability load (kN/m) for deflection limit of Span/150
- $\phi_b W_u$ = Strength load resistance applied at the

- 2-M12 Grade 4.6 bolts per connection
- 2-M12 Grade 8.8 bolts per connection
- 2-M16 Grade 4.6 bolts per connection
- 2-M16 Grade 8.8 bolts per connection

SINGLE SPAN (INWARDS LOAD)

LOAD TABLE – Uniformly Distributed Load

Span (m)	MC 200/15					MC 200/19					MC 200/24					MC 250/15					Span (m)	
	ϕ_{bW_u} kN/m				ws kN/m	ϕ_{bW_u} kN/m				ws kN/m	ϕ_{bW_u} kN/m				ws kN/m	ϕ_{bW_u} kN/m				ws kN/m		
	0	1B	2B	3B		0	1B	2B	3B		0	1B	2B	3B		0	1B	2B	3B			
2.0																					2.0	
2.5																						2.5
3.0	8.85	9.07	9.07	9.07	11.9	11.3	11.9	11.9	11.9	15.6	14.8	16.9	16.9	16.9	20.2	7.39	7.39	7.39	7.39	20.4	3.0	
3.5	6.52	6.66	6.66	6.66	7.48	7.98	8.74	8.74	8.74	9.84	10.4	12.4	12.4	12.4	12.8	6.34	6.34	6.34	6.34	12.8	3.5	
4.0	4.91	5.10	5.10	5.10	5.01	5.94	6.69	6.69	6.69	6.59	7.64	9.48	9.48	9.48	8.54	5.55	5.55	5.55	5.55	8.59	4.0	
4.5	3.83	4.03	4.03	4.03	3.52	4.57	5.29	5.29	5.29	4.63	5.82	7.49	7.49	7.49	6.00	4.47	4.93	4.93	4.93	6.03	4.5	
5.0	3.07	3.26	3.26	3.26	2.57	3.63	4.28	4.28	4.28	3.38	4.58	6.07	6.07	6.07	4.37	3.56	4.03	4.03	4.03	4.40	5.0	
5.5	2.51	2.70	2.70	2.70	1.93	2.94	3.54	3.54	3.54	2.54	3.68	4.96	5.02	5.02	3.29	2.90	3.33	3.33	3.33	3.30	5.5	
6.0	2.09	2.27	2.27	2.27	1.49	2.43	2.97	2.97	2.97	1.95	3.02	4.12	4.21	4.21	2.53	2.41	2.80	2.80	2.80	2.54	6.0	
6.5	1.77	1.93	1.93	1.93	1.17	2.04	2.53	2.53	2.53	1.54	2.52	3.47	3.59	3.59	1.99	2.03	2.39	2.39	2.39	2.00	6.5	
7.0	1.51	1.67	1.67	1.67	0.94	1.74	2.19	2.19	2.19	1.23	2.13	2.97	3.10	3.10	1.59	1.73	2.06	2.06	2.06	1.60	7.0	
7.5	1.31	1.45	1.45	1.45	0.76	1.49	1.90	1.90	1.90	1.00	1.82	2.56	2.70	2.70	1.30	1.49	1.79	1.79	1.79	1.30	7.5	
8.0	1.14	1.28	1.28	1.28	0.63	1.30	1.67	1.67	1.67	0.82	1.57	2.23	2.37	2.37	1.07	1.30	1.58	1.58	1.58	1.07	8.0	
8.5	1.01	1.13	1.13	1.13	0.52	1.14	1.48	1.48	1.48	0.69	1.36	1.96	2.10	2.10	0.89	1.14	1.40	1.40	1.40	0.89	8.5	
9.0	0.89	1.01	1.01	1.01	0.44	1.00	1.32	1.32	1.32	0.58	1.20	1.74	1.86	1.87	0.75	1.01	1.25	1.25	1.25	0.75	9.0	
9.5	0.80	0.90	0.90	0.90	0.37	0.89	1.19	1.19	1.19	0.49	1.06	1.55	1.65	1.68	0.64	0.90	1.11	1.12	1.12	0.64	9.5	
10.0	0.71	0.82	0.82	0.82	0.32	0.80	1.07	1.07	1.07	0.42	0.94	1.39	1.48	1.52	0.55	0.81	1.00	1.01	1.01	0.55	10.0	
10.5	0.64	0.74	0.74	0.74	0.28	0.72	0.96	0.97	0.97	0.36	0.85	1.26	1.34	1.38	0.47	0.73	0.90	0.91	0.91	0.47	10.5	
11.0	0.58	0.67	0.67	0.67	0.24	0.65	0.88	0.88	0.88	0.32	0.76	1.14	1.21	1.25	0.41	0.66	0.82	0.83	0.83	0.41	11.0	
11.5	0.53	0.62	0.62	0.62	0.21	0.59	0.80	0.81	0.81	0.28	0.69	1.04	1.10	1.15	0.36	0.60	0.75	0.76	0.76	0.36	11.5	
12.0	0.48	0.57	0.57	0.57	0.19	0.54	0.73	0.74	0.74	0.24	0.63	0.95	1.01	1.05	0.32	0.55	0.69	0.70	0.70	0.32	12.0	
12.5																0.50	0.63	0.65	0.65	0.28	12.5	
13.0																0.46	0.58	0.60	0.60	0.25	13.0	
13.5																0.43	0.54	0.55	0.55	0.22	13.5	
14.0																					14.0	
14.5																					14.5	
15.0																					15.0	
15.5																					15.5	
16.0																					16.0	
16.5																					16.5	
17.0																					17.0	
17.5																					17.5	
18.0																					18.0	
ϕ_{M_s} kNm	11.86					15.70					20.92					14.24					ϕ_{M_s} kNm	
$\phi_v V_v$ kN	14.02					29.25					64.24					11.09					$\phi_v V_v$ kN	

- 0B = No braces
- 1B = One mid span brace
- 2B = Two equally spaced braces within the span
- 3B = Three equally spaced braces within the span
- ws = Uniformly distributed serviceability load (kN/m) for deflection limit of Span/150
- ϕ_{bW_u} = Strength load resistance applied at the

- 2-M12 Grade 4.6 bolts per connection
- 2-M12 Grade 8.8 bolts per connection
- 2-M16 Grade 4.6 bolts per connection
- 2-M16 Grade 8.8 bolts per connection

SINGLE SPAN (INWARDS LOAD)

LOAD TABLE – Uniformly Distributed Load

	MC 250/19					MC 250/24					MC 300/24 (90)					MC 300/24 (100)							
Span (m)	$\phi_b W_u$ kN/m				w_s kN/m	$\phi_b W_u$ kN/m				w_s kN/m	$\phi_b W_u$ kN/m				w_s kN/m	$\phi_b W_u$ kN/m				w_s kN/m	Span (m)		
	0	1B	2B	3B		0	1B	2B	3B		0	1B	2B	3B		0	1B	2B	3B				
2.0																						2.0	
2.5																							2.5
3.0	14.6	14.9	14.9	14.9	27.0	19.5	21.4	21.4	21.4	36.0	25.5	26.2	26.2	26.2	56.2	26.5	26.6	26.6	26.6	59.0		3.0	
3.5	10.4	10.9	10.9	10.9	17.0	13.6	15.7	15.7	15.7	22.7	17.5	19.3	19.3	19.3	35.4	18.5	19.5	19.5	19.5	37.1		3.5	
4.0	7.80	8.36	8.36	8.36	11.4	9.95	12.0	12.0	12.0	15.2	12.7	14.8	14.8	14.8	23.7	13.3	15.0	15.0	15.0	24.9		4.0	
4.5	6.03	6.61	6.61	6.61	8.00	7.54	9.51	9.51	9.51	10.7	9.51	11.7	11.7	11.7	16.7	9.9	11.8	11.8	11.8	17.5		4.5	
5.0	4.75	5.35	5.35	5.35	5.83	5.89	7.70	7.70	7.70	7.77	7.35	9.44	9.44	9.44	12.1	7.6	9.6	9.6	9.6	12.7		5.0	
5.5	3.83	4.42	4.42	4.42	4.38	4.71	6.36	6.36	6.36	5.84	5.83	7.80	7.80	7.80	9.12	6.0	7.9	7.9	7.9	9.6		5.5	
6.0	3.14	3.72	3.72	3.72	3.38	3.84	5.35	5.35	5.35	4.50	4.72	6.56	6.56	6.56	7.0	4.80	6.64	6.64	6.64	7.37		6.0	
6.5	2.62	3.17	3.17	3.17	2.65	3.17	4.56	4.56	4.56	3.54	3.91	5.59	5.59	5.59	5.52	3.95	5.66	5.66	5.66	5.80		6.5	
7.0	2.22	2.73	2.73	2.73	2.13	2.66	3.93	3.93	3.93	2.83	3.28	4.82	4.82	4.82	4.42	3.31	4.88	4.88	4.88	4.64		7.0	
7.5	1.90	2.38	2.38	2.38	1.73	2.26	3.42	3.42	3.42	2.30	2.78	4.20	4.20	4.20	3.60	2.81	4.25	4.25	4.25	3.77		7.5	
8.0	1.65	2.09	2.09	2.09	1.42	1.95	2.98	3.01	3.01	1.90	2.38	3.69	3.69	3.69	2.96	2.41	3.74	3.74	3.74	3.11		8.0	
8.5	1.44	1.85	1.85	1.85	1.19	1.69	2.61	2.66	2.66	1.58	2.07	3.27	3.27	3.27	2.47	2.10	3.31	3.31	3.31	2.59		8.5	
9.0	1.26	1.65	1.65	1.65	1.00	1.49	2.30	2.38	2.38	1.33	1.81	2.91	2.91	2.91	2.08	1.84	2.95	2.95	2.95	2.18		9.0	
9.5	1.12	1.48	1.48	1.48	0.85	1.31	2.05	2.13	2.13	1.13	1.60	2.62	2.62	2.62	1.77	1.63	2.65	2.65	2.65	1.86		9.5	
10.0	1.00	1.34	1.34	1.34	0.73	1.17	1.83	1.93	1.93	0.97	1.42	2.36	2.36	2.36	1.52	1.45	2.39	2.39	2.39	1.59		10.0	
10.5	0.90	1.12	1.12	1.12	0.63	1.05	1.65	1.75	1.75	0.84	1.27	2.12	2.14	2.14	1.31	1.30	2.17	2.17	2.17	1.38		10.5	
11.0	0.80	1.11	1.11	1.11	0.55	0.94	1.49	1.59	1.59	0.73	1.14	1.92	1.95	1.95	1.14	1.17	1.98	1.98	1.98	1.20		11.0	
11.5	0.73	1.01	1.01	1.01	0.48	0.85	1.35	1.46	1.46	0.64	1.03	1.74	1.78	1.78	1.00	1.06	1.79	1.81	1.81	1.14		11.5	
12.0	0.67	0.93	0.93	0.93	0.42	0.78	1.23	1.34	1.34	0.56	0.94	1.58	1.64	1.64	0.88	0.96	1.63	1.66	1.66	0.92		12.0	
12.5	0.61	0.85	0.86	0.86	0.37	0.71	1.13	1.23	1.23	0.50	0.86	1.45	1.51	1.51	0.78	0.88	1.49	1.53	1.53	0.82		12.5	
13.0	0.56	0.79	0.79	0.79	0.33	0.65	1.04	1.14	1.14	0.44	0.79	1.33	1.40	1.40	0.69	0.80	1.36	1.42	1.42	0.72		13.0	
13.5	0.51	0.73	0.73	0.73	0.30	0.60	0.96	1.05	1.06	0.39	0.72	1.22	1.30	1.30	0.62	0.74	1.25	1.31	1.31	0.65		13.5	
14.0						0.55	0.89	0.97	0.98	0.35	0.67	1.13	1.20	1.20	0.55	1.16	1.22	1.22	1.22	0.58		14.0	
14.5						0.51	0.88	0.90	0.92	0.32	0.62	1.04	1.12	1.12	0.50	1.07	1.14	1.14	1.14	0.52		14.5	
15.0						0.48	0.76	0.83	0.86	0.29	0.57	0.97	1.05	1.05	0.45	0.99	1.06	1.06	1.06	0.47		15.0	
15.5											0.53	0.90	0.98	0.98	0.41	0.92	1.00	1.00	1.00	0.43		15.5	
16.0											0.50	0.84	0.92	0.92	0.37	0.86	0.93	0.93	0.93	0.39		16.0	
16.5											0.46	0.79	0.87	0.87	0.34	0.80	0.88	0.88	0.88	0.35		16.5	
17.0											0.43	0.74	0.82	0.82	0.31	0.75	0.83	0.83	0.83	0.32		17.0	
17.5											0.41	0.69	0.77	0.77	0.28	0.71	0.78	0.78	0.78	0.30		17.5	
18.0											0.38	0.65	0.72	0.73	0.26	0.66	0.74	0.74	0.74	0.27		18.0	
ϕM_s kNm	19.43					28.76					35.64					35.89					ϕM_s kNm		
$\phi_v V_v$ kN	23.11					50.70					41.87					41.87					$\phi_v V_v$ kN		

- 0B = No braces
- 1B = One mid span brace
- 2B = Two equally spaced braces within the span
- 3B = Three equally spaced braces within the span
- w_s = Uniformly distributed serviceability load (kN/m) for deflection limit of Span/150
- $\phi_b W_u$ = Strength load resistance applied at the

- 2-M12 Grade 4.6 bolts per connection
- 2-M12 Grade 8.8 bolts per connection
- 2-M16 Grade 4.6 bolts per connection
- 2-M16 Grade 8.8 bolts per connection

SINGLE SPAN (INWARDS LOAD)

LOAD TABLE – Uniformly Distributed Load

Span (m)	MC 300/30 (90)					MC 300/30 (100)					MC 400/24					MC400/30					Span (m)		
	$\Phi_b W_u$ kN/m				ws kN/m	$\Phi_b W_u$ kN/m				ws kN/m	$\Phi_b W_u$ kN/m				ws kN/m	$\Phi_b W_u$ kN/m				ws kN/m			
	0	1B	2B	3B		0	1B	2B	3B		0	1B	2B	3B		0	1B	2B	3B				
2.0																						2.0	
2.5																							2.5
3.0	32.5	35.9	35.9	35.9	71.5	34.0	36.4	36.4	36.4	75.3	20.8	20.8	20.8	20.8	120	40.8	40.8	40.8	40.8	154	154	3.0	
3.5	22.1	26.4	26.4	26.4	45.1	23.2	26.7	26.7	26.7	47.4	17.8	17.8	17.8	17.8	75.6	35.0	35.0	35.0	35.0	96.9	96.9	3.5	
4.0	16.6	20.5	20.5	20.5	30.2	15.1	15.1	15.1	15.1	31.8	15.6	15.6	15.6	15.6	50.7	26.6	30.6	30.6	30.6	64.9	64.9	4.0	
4.5	11.3	15.9	15.9	15.9	21.2	12.2	16.2	16.2	16.2	22.3	13.9	13.9	13.9	13.9	35.6	19.2	25.0	25.0	25.0	45.6	45.6	4.5	
5.0	8.5	12.9	12.9	12.9	15.5	9.2	13.1	13.1	13.1	16.3	11.8	12.5	12.5	12.5	25.9	14.1	20.3	20.3	20.3	33.2	33.2	5.0	
5.5	6.7	10.7	10.7	10.7	11.6	7.1	10.8	10.8	10.8	12.2	9.42	11.4	11.4	11.4	19.5	10.8	16.7	16.7	16.7	25.0	25.0	5.5	
6.0	5.35	8.97	8.97	8.97	8.94	5.66	9.10	9.10	9.10	9.42	7.57	10.3	10.3	10.3	15.0	8.4	14.1	14.1	14.1	19.2	19.2	6.0	
6.5	4.40	7.64	7.64	7.64	7.03	4.61	7.75	7.75	7.75	7.41	6.19	8.76	8.76	8.76	11.8	6.78	12.0	12.0	12.0	15.1	15.1	6.5	
7.0	3.68	6.59	6.59	6.59	5.63	3.82	6.69	6.69	6.69	5.93	5.12	7.55	7.55	7.55	9.45	5.56	10.3	10.3	10.3	12.1	12.1	7.0	
7.5	3.12	5.69	5.74	5.74	4.58	3.22	5.82	5.82	5.82	4.82	4.29	6.58	6.58	6.58	7.69	4.64	8.07	8.07	8.07	9.85	9.85	7.5	
8.0	2.67	4.92	5.04	5.04	3.77	2.75	5.08	5.12	5.12	3.97	3.65	5.77	5.78	5.78	6.33	3.93	7.91	7.91	7.91	8.11	8.11	8.0	
8.5	2.31	4.29	4.47	4.47	3.15	2.38	4.42	4.53	4.53	3.31	3.13	5.05	5.12	5.12	5.28	3.37	7.01	7.01	7.01	6.77	6.77	8.5	
9.0	2.02	3.77	3.99	3.99	2.65	2.08	3.88	4.04	4.04	2.79	2.72	4.46	4.57	4.57	4.45	2.92	6.25	6.25	6.25	5.70	5.70	9.0	
9.5	1.78	3.34	3.58	3.58	2.25	1.83	3.43	3.63	3.63	2.37	0.39	0.40	0.41	0.41	3.78	2.56	5.52	5.61	5.61	4.85	4.85	9.5	
10.0	1.58	2.97	3.23	3.23	1.93	1.62	3.05	3.28	3.28	2.03	2.11	3.54	3.70	3.70	3.24	2.26	4.90	5.06	5.06	4.15	4.15	10.0	
10.5	1.41	2.66	2.93	2.93	1.67	1.45	2.73	2.97	2.97	1.76	1.88	3.18	3.36	3.36	2.80	2.01	4.37	4.59	4.59	3.59	3.59	10.5	
11.0	1.27	2.40	2.67	2.67	1.45	1.30	2.46	2.71	2.71	1.53	1.68	2.87	3.06	3.06	2.44	1.79	3.92	4.18	4.18	3.12	3.12	11.0	
11.5	1.14	2.17	2.44	2.44	1.27	1.18	2.22	2.48	2.48	1.34	1.51	2.60	2.80	2.80	2.13	1.61	3.54	3.83	3.83	2.73	2.73	11.5	
12.0	1.04	1.97	2.24	2.24	1.12	1.07	2.01	2.28	2.28	1.18	1.37	2.37	2.57	2.57	1.88	1.46	3.20	3.52	3.52	2.40	2.40	12.0	
12.5	0.95	1.80	2.05	2.07	0.99	0.98	1.83	2.10	2.10	1.04	1.24	2.17	2.37	2.37	1.66	1.33	2.91	3.24	3.24	2.13	2.13	12.5	
13.0	0.85	1.65	1.88	1.91	0.88	0.89	1.68	1.93	1.94	0.93	1.13	1.99	2.19	2.19	1.48	1.21	2.65	3.00	3.00	1.89	1.89	13.0	
13.5	0.79	1.51	1.73	1.77	0.79	0.82	1.54	1.78	1.80	0.83	1.04	1.83	2.02	2.03	1.32	1.11	2.42	2.78	2.78	1.69	1.69	13.5	
14.0	0.73	1.39	1.59	1.67	0.70	0.76	1.42	1.64	1.67	0.74	0.96	1.69	1.87	1.89	1.18	1.02	2.21	2.58	2.58	1.51	1.51	14.0	
14.5	0.68	1.29	1.47	1.54	0.63	0.70	1.31	1.51	1.56	0.67	0.88	1.57	1.73	1.76	1.06	0.94	2.03	2.41	2.41	1.36	1.36	14.5	
15.0	0.63	1.19	1.36	1.44	0.57	0.65	1.21	1.40	1.46	0.60	0.82	1.45	1.61	1.64	0.96	0.87	1.87	2.25	2.25	1.23	1.23	15.0	
15.5	0.58	1.10	1.27	1.34	0.52	0.60	1.12	1.30	1.36	0.55	0.76	1.35	1.49	1.54	0.87	0.81	1.73	2.09	2.11	1.12	1.12	15.5	
16.0	0.54	1.03	1.18	1.26	0.47	0.56	1.05	1.21	1.28	0.50	0.70	1.26	1.39	1.45	0.79	0.75	1.60	1.94	1.98	1.01	1.01	16.0	
16.5	0.51	0.96	1.10	1.19	0.43	0.52	0.98	1.13	1.20	0.45	0.66	1.18	1.30	1.36	0.72	0.70	1.49	1.81	1.86	0.92	0.92	16.5	
17.0	0.48	0.89	1.03	1.11	0.39	0.49	0.91	1.05	1.14	0.41	0.63	1.11	1.22	1.28	0.66	0.65	1.39	1.69	1.75	0.85	0.85	17.0	
17.5	0.45	0.84	0.96	1.04	0.36	0.46	0.85	0.99	1.07	0.38	0.57	1.04	1.15	1.21	0.61	0.61	1.29	1.58	1.65	0.75	0.75	17.5	
18.0	0.42	0.78	0.90	0.97	0.33	0.43	0.80	0.92	1.01	0.35	0.54	0.98	1.08	1.14	0.56	0.57	1.21	1.48	1.56	0.71	0.71	18.0	
ΦM_s kNm	48.98					50.05					53.53					75.38					ΦM_s kNm		
$\Phi_v V_v$ kN	82.13					82.13					31.46					62.96					$\Phi_v V_v$ kN		

- 0B = No braces
- 1B = One mid span brace
- 2B = Two equally spaced braces within the span
- 3B = Three equally spaced braces within the span
- ws = Uniformly distributed serviceability load (kN/m) for deflection limit of Span/150
- $\Phi_b W_u$ = Strength load resistance applied at the

- 2-M12 Grade 4.6 bolts per connection
- 2-M12 Grade 8.8 bolts per connection
- 2-M16 Grade 4.6 bolts per connection
- 2-M16 Grade 8.8 bolts per connection



MS TOPHATS

CONTENTS

MSTophats Design Guide	190
MSTophats Span Guide	191
Single Span (MSTophat)	192
Lapped Span (MSTophat)	194
MSTophats Section	196
MSTophats Floor Joist Spans	197

MS TOPHATS DESIGN GUIDE

INTRODUCTION

MS Tophat can be used for roof purlins, wall girts and floor joists, and are an economic option for these and other applications including carports and fencing. They are an economical alternative to timber and C section purlins for spans up to 7 meters. Easy to use they fasten directly to their supports which eliminates the requirements for cleats. Being symmetrical there is no requirements for braces or nogs to prevent twisting and allows the profile to be easily lapped for maximum performance. MS Tophats are manufactured from high strength galvanised steel coil, the Z275 min coating provides good protection in most exposed internal environments. Consideration should be given when used in a lined exterior dwelling; thermal breaks are required between the tophat and cladding to avoid thermal bridging. Contact with materials not compatible with zinc should be avoided. MS Tophats comply with the New Zealand Building Code, and are designed to AS/NZS 4600: 1996 Cold formed steel structures.

HANDLING AND STORAGE

Care should be taken to ensure MS Tophats are kept dry during transportation and storage. The presence of water between the stacked sections will create premature corrosion, it is recommended the tophats are separated and dried if this situation occurs. Cutting if required should be done with hacksaws or snips, use of abrasive disc blades is not recommended.

PURLIN & GIRT

Metalcraft Roofing manufactures MS Tophats, which can be used as Purlins and Girts, for the New Zealand construction market. MS Tophats are cut to length and are available in a range of sizes and gauges to suit a variety of applications.

The MS Tophats are manufactured from high tensile Z275 galvanised coil in accordance with AS1397. MS Tophats are an economical alternative to 'C' shaped purlins and girts as well as timber for spans up to 7 metres. For more information on MS Tophats contact your local Metalcraft Roofing Branch.

FLOOR JOISTS

Metalcraft Roofing MS Tophats can be used in a variety of applications, one of those being as a floor joist. For further information on MS Tophats being used in this way please contact your local Metalcraft Roofing Branch.

DISCLAIMER

This publication is intended to provide accurate information to the best of our knowledge in regards to MS Tophats Sections. It does not constitute a complete description of the goods nor an express statement about their suitability for any particular purpose. All data is provided as a guide only and Metalcraft Roofing do not accept any liability for loss or damage suffered from the use of this data.

MS TOPHATS SPAN GUIDE

Tophat Purlin	Mass kg/m	Spacing	1.8	2.0	2.2	2.4	2.6	2.8	3.0	3.2	3.4	3.6	3.8	4.0	4.2	4.4	4.6	4.8	5.0	5.2	5.4	5.6	5.8	6.0	6.2	6.4	6.6	6.8	7.0	7.2	7.4	7.6	7.8	8.0				
			[Span ranges indicated by bars]																																			
60 x 0.75 BMT	1.18	1.2	[Single Span]		[Lapped Span]																																	
		1.8	[Single Span]	[Lapped Span]																																		
60 x 0.95 BMT	1.50	1.2	[Single Span]		[Lapped Span]																																	
		1.8	[Single Span]	[Lapped Span]																																		
100 x 0.75 BMT	1.93	1.2							[Single Span]		[Lapped Span]																											
		1.8							[Single Span]				[Lapped Span]																									
100 x 0.95 BMT	2.45	1.2							[Single Span]		[Lapped Span]																											
		1.8							[Single Span]				[Lapped Span]																									
120 x 0.75 BMT	2.17	1.2							[Single Span]				[Lapped Span]																									
		1.8							[Single Span]								[Lapped Span]																					
120 x 0.95 BMT	2.75	1.2							[Single Span]				[Lapped Span]																									
		1.8							[Single Span]								[Lapped Span]																					
150 x 0.95 BMT	3.21	1.2							[Single Span]				[Lapped Span]																									
		1.8							[Single Span]								[Lapped Span]																					
150 x 1.15 BMT	3.88	1.2							[Single Span]				[Lapped Span]																									
		1.8							[Single Span]								[Lapped Span]																					

NOTE: This chart is for quick reference only. Each situation should be considered separately and designed using standard procedures. FOR FURTHER INFORMATION AND ORDERS CONTACT METALCRAFT STRUCTURAL OR ROOFING

Single Spans 

Lapped Spans 

SINGLE SPAN (MS TOPHAT)

LOAD TABLE – Uniformly Distributed Load

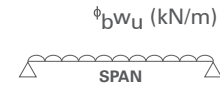

Span (m)	60 x 0.75			60 x 0.95			100 x 0.75			100 x 0.95			120 x 0.75		
	ϕ_{bw_u} kN/m		W_s kN/m	ϕ_{bw_u} kN/m		W_s kN/m	ϕ_{bw_u} kN/m		W_s kN/m	ϕ_{bw_u} kN/m		W_s kN/m	ϕ_{bw_u} kN/m		W_s kN/m
Load	Inward	Outward	Defl	Inward	Outward	Defl	Inward	Outward	Defl	Inward	Outward	Defl	Inward	Outward	Defl
2.0	2.30	1.56	0.88	3.08	2.11	1.16	4.54	3.10	3.90						
2.2	1.90	1.29	0.66	2.55	1.75	0.87	3.76	2.66	2.93						
2.4	1.60	1.08	0.51	2.14	1.47	0.67	3.16	2.24	2.26	4.72	2.58	3.08	3.82	2.67	3.34
2.6	1.36	0.92	0.40	1.83	1.25	0.53	2.69	1.91	1.78	4.02	2.38	2.42	3.26	2.27	2.62
2.8	1.18	0.80	0.32	1.57	1.08	0.42	2.32	1.64	1.42	3.47	2.21	1.94	2.81	1.96	2.10
3.0				1.37	0.94	0.34	2.02	1.43	1.16	3.02	2.00	1.58	2.45	1.71	1.71
3.2				1.20	0.83	0.28	1.78	1.26	0.95	2.66	1.76	1.30	2.15	1.50	1.41
3.4							1.57	1.11	0.79	2.35	1.56	1.08	1.90	1.33	1.17
3.6							1.40	0.99	0.67	2.10	1.39	0.91	1.70	1.19	0.99
3.8							1.26	0.89	0.57	1.88	1.25	0.78	1.52	1.06	0.84
4.0							1.14	0.81	0.49	1.70	1.13	0.67	1.38	0.96	0.72
4.2							1.03	0.73	0.42	1.54	1.02	0.58	1.25	0.87	0.62
4.4							0.94	0.67	0.37	1.40	0.93	0.50	1.14	0.79	0.54
4.6							0.86	0.61	0.32	1.28	0.85	0.44	1.04	0.73	0.47
4.8							0.79	0.56	0.28	1.18	0.78	0.39	0.96	0.67	0.42
5.0										1.09	0.72	0.34	0.88	0.61	0.37
5.2										1.01	0.67	0.30	0.81	0.57	0.33
5.4										0.93	0.62	0.27	0.75	0.53	0.29
5.6												0.24	0.70	0.49	0.26
5.8															
6.0															
6.2															
6.4															
6.6															
6.8															
7.0															
7.2															
7.4															
7.6															
7.8															
8.0															
8.2															
8.4															
8.6															
8.8															
9.0															
Fixings Steel/ Timber Cold Formed	2/12 g 2/12 g/1.2 mm			2/12 g 2/12 g/1.2 mm			4/12 g 2/12 g/1.5 mm			4/12 g 2/12 g/1.5 mm			4/14 g 2/14 g/1.5 mm		

Steel/Timber Fixings = Number and gauge of Tek screws fixing to G300 hot rolled steel a minimum of 3mm thick or type T17 tek screws a minimum of 37mm into timber.

Cold Formed Fixings = Number and gauge of screws and minimum thickness of G450 cold formed support member.

Outward Loads = Must be adjusted if support member thickness or grades are lower.

The above loads assume the Top Flange is fully restrained by the sheeting.

W_s = Uniformly distributed serviceability load (kN/m) for deflection limit of Span/150.

ϕ_{bw_u} = Dependable Strength load resistance applied at the centroid (kN/m)

SINGLE SPAN (MS TOPHAT)

LOAD TABLE – Uniformly Distributed Load

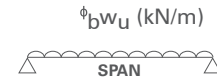

Span (m)	120 x 0.95			150 x 0.95			150 x 1.15			150 x 1.55		
	$\phi_b w_u$ kN/m		W_s kN/m	$\phi_b w_u$ kN/m		W_s kN/m	$\phi_b w_u$ kN/m		W_s kN/m	$\phi_b w_u$ kN/m		W_s kN/m
Load	Inward	Outward	Defl	Inward	Outward	Defl	Inward	Outward	Defl	Inward	Outward	Defl
2.0												
2.2												
2.4												
2.6	4.85	3.43	3.73									
2.8	4.18	2.96	2.99									
3.0	3.64	2.58	2.43	4.57	3.07	3.91						
3.2	3.20	2.26	2.00	4.02	2.78	3.22						
3.4	2.84	2.01	1.67	3.56	2.46	2.69	4.93	2.71	3.73			
3.6	2.53	1.79	1.41	3.18	2.20	2.26	4.39	2.56	3.01			
3.8	2.27	1.61	1.19	2.85	1.97	1.93	3.94	2.42	2.56	6.41	3.93	3.51
4.0	2.05	1.45	1.02	2.57	1.78	1.65	3.56	2.30	2.19	5.78	3.55	3.01
4.2	1.86	1.31	0.88	2.33	1.62	1.43	3.23	2.19	1.90	5.24	3.22	2.60
4.4	1.69	1.20	0.77	2.13	1.47	1.24	2.94	2.09	1.65	4.78	2.93	2.26
4.6	1.55	1.10	0.67	1.95	1.35	1.09	2.69	1.91	1.44	4.37	2.68	1.98
4.8	1.42	1.01	0.59	1.79	1.24	0.96	2.47	1.75	1.27	4.02	2.46	1.74
5.0	1.31	0.93	0.52	1.65	1.14	0.85	2.28	1.62	1.12	3.70	2.27	1.54
5.2	1.21	0.86	0.47	1.52	1.05	0.75	2.11	1.50	1.00	3.42	2.10	1.37
5.4	1.12	0.79	0.42	1.41	0.98	0.67	1.95	1.39	0.89	3.17	1.95	1.22
5.6	1.05	0.74	0.37	1.31	0.91	0.60	1.82	1.29	0.80	2.95	1.81	1.10
5.8	0.97	0.69	0.34	1.22	0.85	0.54	1.69	1.20	0.72	2.75	1.69	0.99
6.0	0.91	0.64	0.30	1.14	0.79	0.49	1.58	1.12	0.65	2.57	1.58	0.89
6.2	0.85	0.60	0.28	1.07	0.74	0.44	1.48	1.05	0.59	2.41	1.48	0.81
6.4				1.00	0.70	0.40	1.39	0.99	0.54	2.26	1.39	0.74
6.6				0.94	0.65	0.37	1.31	0.93	0.49	2.12	1.30	0.67
6.8				0.89	0.62	0.34	1.23	0.87	0.45	2.00	1.23	0.61
7.0				0.84	0.58	0.31	1.16	0.83	0.41	1.89	1.16	0.56
7.2				0.79	0.55	0.28	1.10	0.78	0.38	1.78	1.09	0.52
7.4							1.04	0.74	0.35	1.69	1.04	0.48
7.6							0.99	0.70	0.32	1.60	0.98	0.44
7.8							0.94	0.66	0.30	1.52	0.93	0.41
8.0							0.89	0.63	0.27	1.45	0.89	0.38
8.2										1.38	0.84	0.35
8.4										1.31	0.80	0.33
8.6										1.25	0.77	0.30
8.8												
9.0												
Fixings Steel/ Timber Cold Formed	2/14 g 2/14 g/1.5 mm			2/14 g 2/14 g/1.5 mm			2/14 g 2/14 g/1.5 mm			2/12 g 4/12 g/1.5 mm		

Steel/Timber Fixings = Number and gauge of Tek screws fixing to G300 hot rolled steel a minimum of 3mm thick or type T17 tek screws a minimum of 37mm into timber.

Cold Formed Fixings = Number and gauge of screws and minimum thickness of G450 cold formed support member.

Outward Loads = Must be adjusted if support member thickness or grades are lower.

The above loads assume the Top Flange is fully restrained by the sheeting.

W_s = Uniformly distributed serviceability load (kN/m) for deflection limit of Span/150.

$\phi_b w_u$ = Dependable Strength load resistance applied at the centroid (kN/m)

LAPPED SPAN (MS TOPHAT)

LOAD TABLE – Uniformly Distributed Load



Span (m)	60 x 0.75			60 x 0.95			100 x 0.75			100 x 0.95			120 x 0.75		
	$\phi_b w_u$ kN/m		W_s kN/m	$\phi_b w_u$ kN/m		W_s kN/m	$\phi_b w_u$ kN/m		W_s kN/m	$\phi_b w_u$ kN/m		W_s kN/m	$\phi_b w_u$ kN/m		W_s kN/m
Load	Inward	Outward	Defl	Inward	Outward	Defl	Inward	Outward	Defl	Inward	Outward	Defl	Inward	Outward	Defl
2.0	3.37	2.40	1.89	4.58	2.48	2.46	7.38	3.36	8.27						
2.2	2.69	2.10	1.42	3.65	2.25	1.85	6.10	3.05	8.22						
2.4	2.16	1.76	1.09	2.94	2.07	1.43	5.13	2.80	4.79	7.67	4.20	6.43	5.14	4.60	7.26
2.6	1.76	1.50	0.86	2.39	1.19	1.12	4.37	2.58	3.77	6.54	3.88	5.06	4.74	4.50	5.71
2.8	1.44	1.29	0.69	1.96	1.75	0.90	3.77	2.40	3.02	5.64	3.60	4.05	4.41	3.94	4.57
3.0	1.19	1.13	0.56	1.61	1.53	0.73	3.28	2.24	2.45	4.91	3.36	3.29	3.97	3.68	3.72
3.2	1.05	0.99	0.46	1.42	1.34	0.60	2.88	2.10	2.02	4.31	3.15	2.71	3.49	3.45	3.06
3.4	0.93	0.88	0.38	1.26	1.19	0.50	2.56	1.98	1.68	3.82	2.96	2.26	3.09	3.24	2.55
3.6	0.83	0.78	0.32	1.12	1.06	0.42	2.28	1.87	1.42	3.41	2.80	1.90	2.76	2.89	2.15
3.8				1.01	0.95	0.36	2.05	1.77	1.21	3.06	2.65	1.62	2.48	2.59	1.83
4.0				0.91	0.86	0.31	1.85	1.68	1.03	2.76	2.52	1.39	2.24	2.34	1.57
4.2							1.67	1.60	0.89	2.50	2.40	1.20	2.03	2.12	1.36
4.4							1.53	1.53	0.78	2.28	2.27	1.04	1.85	1.93	1.18
4.6							1.40	1.46	0.68	2.09	2.07	0.91	1.69	1.77	1.03
4.8							1.28	1.36	0.60	1.92	1.90	0.80	1.55	1.63	0.91
5.0							1.18	1.25	0.53	1.77	1.76	0.71	1.43	1.50	0.80
5.2							1.09	1.16	0.47	1.63	1.62	0.63	1.32	1.39	0.71
5.4							1.01	1.07	0.42	1.52	1.50	0.56	1.23	1.28	0.64
5.6							0.94	1.00	0.38	1.41	1.40	0.51	1.14	1.19	0.57
5.8							0.88	0.93	0.34	1.31	1.30	0.46	1.06	1.11	0.51
6.0							0.82	0.87	0.31	1.23	1.22	0.41	0.99	1.04	0.46
6.2										1.15	1.14	0.37	0.93	0.97	0.42
6.4										1.08	1.07	0.34	0.87	0.91	0.38
6.6										1.01	1.01	0.31	0.82	0.86	0.35
6.8										0.96	0.95	0.28	0.77	0.81	0.32
7.0													0.73	0.76	0.29
7.2													0.69	0.72	0.27
7.4															
7.6															
7.8															
8.0															
8.2															
8.4															
8.6															
8.8															
9.0															
Fixings Steel/ Timber Cold Formed	2/12 g 4/12 g/1.2 mm			2/12 g 4/12 g/1.2 mm			4/12 g 4/12 g/1.5 mm			4/12 g 6/12 g/1.5 mm			4/14 g 6/14 g/1.5 mm		

Steel/Timber Fixings = Number and gauge of Tek screws fixing to G300 hot rolled steel a minimum of 3mm thick or type T17 tek screws a minimum of 37mm into timber.

Cold Formed Fixings = Number and gauge of screws and minimum thickness of G450 cold formed support member.

Outward Loads = Must be adjusted if support member thickness or grades are lower.

The above loads assume the Top Flange is fully restrained by the sheeting.

Total lap length shall be 15% of the maximum adjacent span.
60MS Tophat Lap ends to be fixed with Tek screws (one in each web)
100/120/150 MS Tophat Lap ends to be fixed with 4 Tek screws (one in each web and flange).

W_s = Uniformly distributed serviceability load (kN/m) for deflection limit of Span/150.

$\phi_b w_u$ = Dependable Strength load resistance applied at the centroid (kN/m)

LAPPED SPAN (MS TOPHAT)

LOAD TABLE – Uniformly Distributed Load

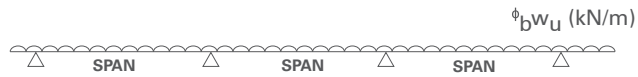

Span (m)	120 x 0.95			150 x 0.95			150 x 1.15			150 x 1.55			
	$\phi_b w_u$ kN/m		W_s kN/m	$\phi_b w_u$ kN/m		W_s kN/m	$\phi_b w_u$ kN/m		W_s kN/m	$\phi_b w_u$ kN/m		W_s kN/m	
Load	Inward	Outward	Defl	Inward	Outward	Defl	Inward	Outward	Defl	Inward	Outward Steel/Timber	Outward Cold Formed	Defl
2.0													
2.2													
2.4													
2.6													
2.8	6.79	3.94	6.25										
3.0	5.92	3.68	5.08										
3.2	5.20	3.45	4.19	6.18	3.45	6.98							
3.4	4.61	3.25	3.49	5.79	3.25	5.82							
3.6	4.11	3.07	2.94	5.16	3.07	4.90	7.14	4.09	6.29				
3.8	3.69	2.91	2.50	4.63	2.91	4.17	6.41	3.87	5.35	10.41	5.05	3.87	7.28
4.0	3.33	2.75	2.15	4.18	2.76	3.58	5.78	3.68	4.58	9.40	4.80	3.68	6.24
4.2	3.02	2.63	1.85	3.79	2.63	3.09	5.25	3.50	3.96	8.52	4.57	3.50	5.39
4.4	2.75	2.51	1.61	3.46	2.51	2.69	4.78	3.35	3.44	7.77	4.36	3.53	4.69
4.6	2.52	2.40	1.41	3.16	2.40	2.35	4.37	3.20	3.01	7.10	4.17	3.20	4.11
4.8	2.31	2.30	1.24	2.90	2.30	2.07	4.02	3.07	2.65	6.52	4.00	3.07	3.61
5.0	2.13	2.21	1.10	2.68	2.21	1.83	3.70	2.94	2.35	6.01	3.84	2.94	3.20
5.2	1.97	2.08	0.98	2.47	2.12	1.63	3.42	2.83	2.09	5.56	3.69	2.83	2.84
5.4	1.83	1.93	0.87	2.29	2.04	1.45	3.17	2.73	1.86	5.16	3.56	2.73	2.54
5.6	1.70	1.80	0.78	2.13	1.97	1.30	2.95	2.63	1.67	4.67	3.43	2.63	2.28
5.8	1.58	1.67	0.70	1.99	1.90	1.17	2.75	2.54	1.50	4.35	3.31	2.54	2.05
6.0	1.48	1.56	0.64	1.86	1.84	1.06	2.57	2.45	1.36	4.06	3.20	2.45	1.85
6.2	1.39	1.47	0.58	1.74	1.78	0.96	2.41	2.37	1.23	3.81	3.10	2.37	1.68
6.4	1.30	1.38	0.52	1.63	1.70	0.87	2.26	2.30	1.12	3.57	3.00	2.30	1.52
6.6	1.22	1.29	0.48	1.54	1.59	0.80	2.12	2.23	1.02	3.36	2.91	2.23	1.39
6.8	1.15	1.22	0.44	1.45	1.50	0.73	2.00	2.12	0.93	3.16	2.82	2.16	1.27
7.0	1.09	1.15	0.40	1.37	1.42	0.67	1.89	2.00	0.86	2.99	2.74	2.10	1.17
7.2	1.03	1.09	0.37	1.29	1.34	0.61	1.79	1.89	0.79	2.82	2.67	2.04	1.07
7.4	0.97	1.03	0.34	1.22	1.27	0.56	1.69	1.79	0.72	2.67	2.53	1.99	0.99
7.6	0.92	0.98	0.31	1.16	1.20	0.52	1.60	1.69	0.67	2.53	2.40	1.94	0.91
7.8	0.88	0.93	0.29	1.10	1.14	0.48	1.52	1.61	0.62	2.41	2.27	1.89	0.84
8.0	0.83	0.88	0.27	1.05	1.09	0.45	1.45	1.53	0.57	2.29	2.16	1.84	0.78
8.2				0.99	1.03	0.42	1.38	1.46	0.53	2.18	2.06	1.80	0.72
8.4				0.95	0.98	0.39	1.31	1.39	0.49	2.07	1.96	1.75	0.67
8.6				0.90	0.94	0.36	1.25	1.32	0.46	1.98	1.87	1.71	0.63
8.8							1.20	1.25	0.43	1.89	1.79	1.67	0.59
9.0							1.14	1.21	0.40	1.81	1.71	1.64	0.55
Fixings Steel/ Timber Cold Formed	4/14 g 6/14 g/1.5 mm			4/14 g 6/14 g/1.5 mm			6/14 g 8/14 g/1.5 mm			6/12 g 8/14 g/1.5 mm			

Steel/Timber Fixings = Number and gauge of Tek screws fixing to G300 hot rolled steel a minimum of 3mm thick or type T17 tek screws a minimum of 37mm into timber.

Cold Formed Fixings = Number and gauge of screws and minimum thickness of G450 cold formed support member.

Outward Loads = Must be adjusted if support member thickness or grades are lower.

The above loads assume the Top Flange is fully restrained by the sheeting.

Total lap length shall be 15% of the maximum adjacent span.
60MS Tophat Lap ends to be fixed with Tek screws (one in each web)
100/120/150 MS Tophat Lap ends to be fixed with 4 Tek screws (one in each web and flange).

W_s = Uniformly distributed serviceability load (kN/m) for deflection limit of Span/150.

$\phi_b w_u$ = Dependable Strength load resistance applied at the centroid (kN/m)

MS TOPHATS SECTION

MS TOPHATS SECTION GEOMETRY

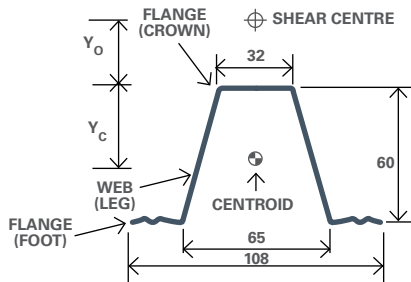

MS 60 TOPHATS

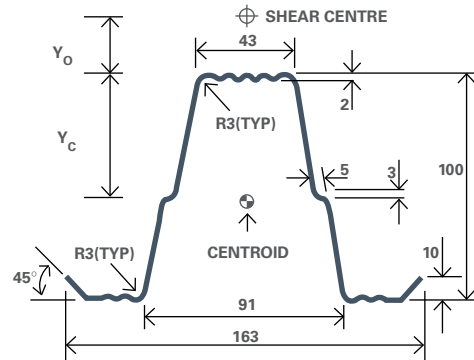

MS 100 TOPHATS

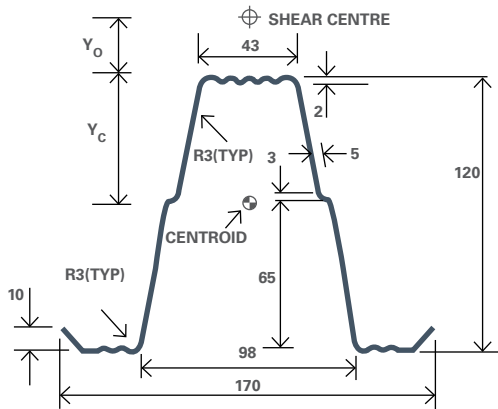

MS 120 TOPHATS

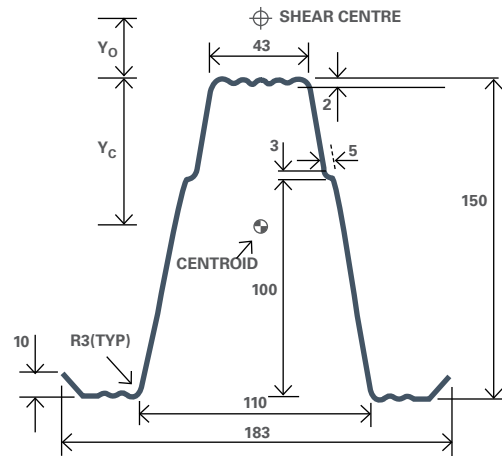

MS 150 TOPHATS

MS TOPHATS SECTION PROPERTIES

CODE	Thickness (BMT) mm	Area mm ²	Mass kg/m	Second Moment		Section Modulus		Radius Of Gyration		Centre Of Gravity Y _c mm	Shear Centre Y _o mm	Torsion Constant J mm ⁴	Warping Constant I _w 10 ⁹ mm ⁶	Mono-Symmetry Constant β _x mm		
				Area		(Full)		Z _x 10 ³ mm ³	Z _y 10 ³ mm ³						r _x mm	r _y mm
				I _x 10 ² mm ⁴	I _y 10 ⁶ mm ⁴	10 ³ mm ³	10 ³ mm ³									
60 x 0.75 BMT	0.75	150	1.18	0.078	0.119	2.45	2.20	22.8	28.1	31.7	44.2	28.2	16.05	110		
60 x 0.95 BMT	0.95	190	1.50	0.098	0.151	3.09	2.78	22.8	28.1	31.7	44.2	57.3	20.33	110		
100 x 0.75 BMT	0.75	248	1.93	0.388	0.439	6.30	5.39	37.1	42.2	55.2	67.4	46.5	238.61	158		
100 x 0.95 BMT	0.95	314	2.45	0.428	0.556	7.75	6.83	37.0	42.2	55.2	67.4	94.5	302.24	158		
120 x 0.75 BMT	0.75	278	2.17	0.527	0.519	8.03	6.13	43.7	43.3	65.6	82.3	52.1	363.31	184		
120 x 0.95 BMT	0.95	352	2.75	0.667	0.657	10.16	7.76	43.6	43.3	65.6	82.3	105.9	460.20	184		
150 x 0.95 BMT	0.95	410	3.21	1.160	0.878	14.30	9.60	53.3	46.3	81.1	103.9	123.5	758.37	225		
150 x 1.15 BMT	1.15	497	3.88	1.400	1.060	17.30	11.62	53.2	46.3	81.1	103.9	219.1	918.02	225		
150 x 1.55 BMT	1.55	670	5.23	1.890	1.430	23.32	15.66	53.2	46.3	81.1	103.9	536.5	1237.33	225		

MS TOPHATS FLOOR JOIST SPANS



CODE	Spacing					
	400		450		600	
	Single	Double	Single	Double	Single	Double
60 x 0.75 BMT	1.05	1.25	1.00	1.20	0.95	1.10
60 x 0.95 BMT	1.15	1.35	1.10	1.30	1.05	1.20
100 x 0.75 BMT	1.80	2.20	1.75	2.05	1.65	1.90
100 x 0.95 BMT	2.00	2.40	1.90	2.25	1.80	2.05
120 x 0.75 BMT	2.20	2.60	2.10	2.45	1.90	2.20
120 x 0.95 BMT	2.40	2.90	2.30	2.70	2.10	2.40
150 x 0.95 BMT	2.90	3.60	2.80	3.30	2.50	2.90
150 x 1.15 BMT	3.20	3.90	3.00	3.60	2.70	3.20
150 x 1.55 BMT	3.60	4.30	3.40	4.10	3.00	3.60

Spans are based on limited floor vibrations and are capable of carrying liveloads of at least 4kPa

SINGLE SPAN AND DOUBLE SPAN

FIXING SUPPORT DETAIL

CORRECT
Tophat Fixing

WRONG
Tophat Fixing

TYPICAL FIXING - LAPPED SECTION

Lap (15% of span minimum) 25mm (approx.)

60 MS TOPHAT

100/120/150 MS TOPHAT

TIMBER/STEEL TYPICAL SCREWED FIXINGS

Screw each side
Refer tables for specific fixing requirements

COLD FORMED TYPICAL SCREWED FIXINGS

Steel/Timber and Cold Formed

Screws each side
Refer tables for specific fixing requirements

STRAPPED FIXING

2 x 14g – 10 x 20 fasteners each side of strap
Fasten strap to web of support each side
Total 4 fastenings

FIXING DETAILS & ASSEMBLY EXAMPLES

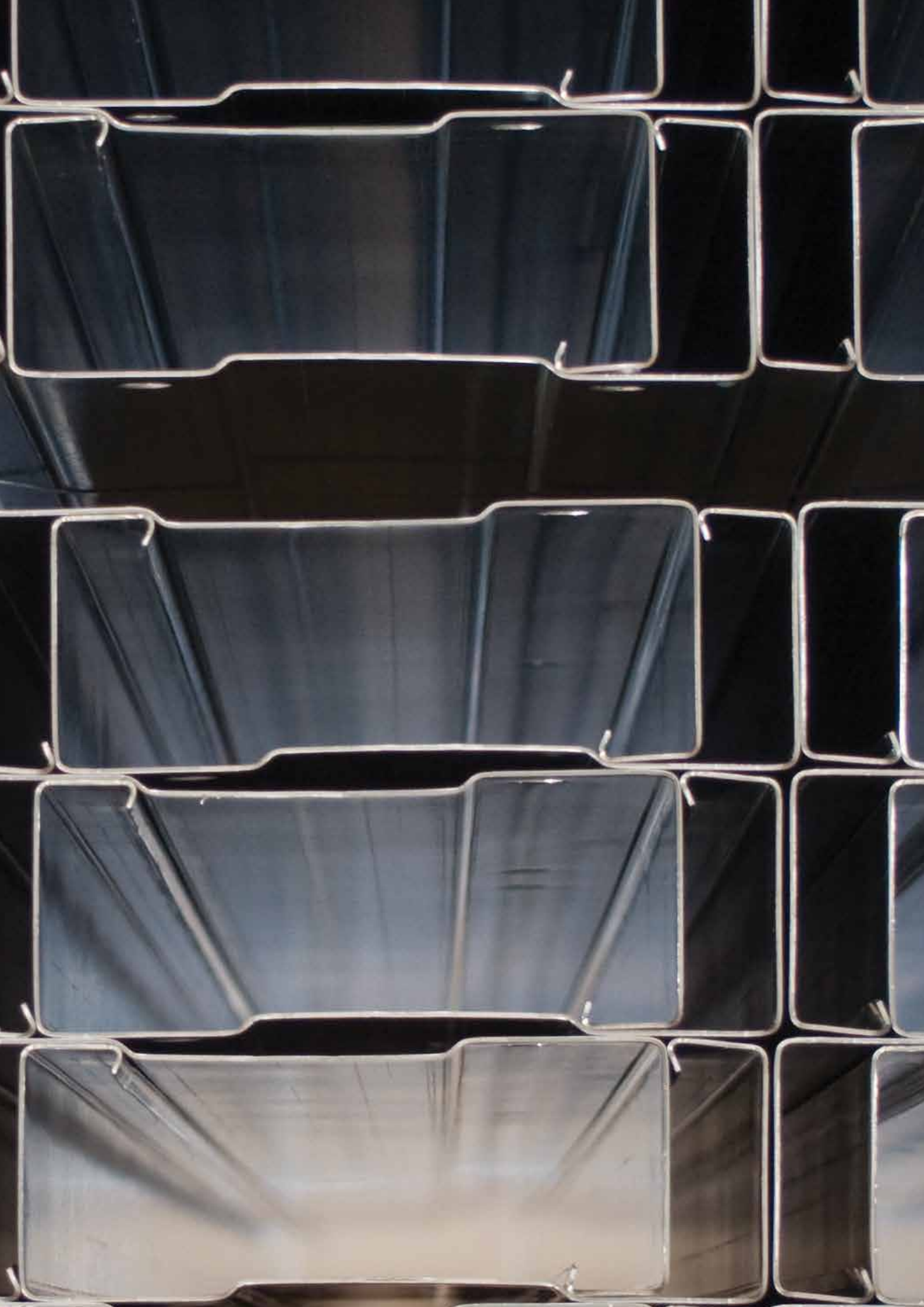

MSS SINGLE SPAN FLOOR JOISTS

CONTENTS

Floor Rigidity Notes	200
MSS Single Span Floor Joists	201
Floor Joist Span Comparisons	205

FLOOR RIGIDITY NOTES

- 1) The span data provided in the following tables is based on limited static deflections to a 21.5mm maximum of Span/300 for combined dead and live loads.
- 2) Humans sensitivity to floor vibrations varies significantly. Some users will have more demanding expectations and accordingly, for vibration assessment, an Engineer should be consulted to consider the exact configuration and loading scenarios.

It is suggested that for normal vibration control, the minimum of the stated allowable span for the given joist spacing, or that for 2mm/1kN point load should be adopted.

This assumes that ceiling battens are fixed at regular spacings to the bottom flange of the joists, or in the situation of no ceiling below, standard ceiling batten or top hat installed perpendicular to the joists at a maximum spacing of 3.0m. For situations requiring greater vibration control, specific Engineering design should be undertaken and consideration given to the following steps to improve vibration performance;

- (a) Use a deeper floor joist section to increase stiffness
- (b) Reduce the joist spacing

Note: Floor Vibration performance tends to improve with added damping through installation of ceilings, partition walls, floor coverings and furniture.

- 3) Support of joists is assumed to be via web and flange connection to supporting structure. Actual project connection detailing and design to be by Specific Engineering Design carried out by a Chartered Professional Engineer. In situations where support connection capacity is critical, joist sizes and spacing may need to be reduced from that suggested in the following tables.
- 4) Durability requirements shall be reviewed on a project by project basis, in accordance with the NZBC and relevant design standards and specifications. Refer to MSS section manual for details on section coatings for corrosion protection.
- 5) Floor span calculations provided by Blueprint Consulting Ltd.

MSS SINGLE SPAN FLOOR JOISTS

DESIGN CASE 1

Total Floor Dead Load 0.5 kPa includes SDL

Floor Live Load 1.5 kPa

NOTE: Dead Load is typical for suspended floor with timber flooring, carpet, and gib ceiling on battens below.

MSS Section ^c	Dynamic Span Limits ^b			Spans (mm) for Joist Spacing Based on Strength and Stiffness ^a		
	Limit Deflection 1mm/1kN	Limit Deflection 2mm/1kN	Limit Deflection 3mm/1kN	300mm	400mm	600mm
MSS 150/12	2350	2950	3400	4950	4600	4100
MSS 150/15	2500	3200	3650	5200	4850	4400
MSS 150/18	2650	3350	3850	5450	5050	4550
MSS 150/23	2900	3650	4200	5800	5400	4850
MSS 200/12	3050	3800	4400	6000	5550	5050
MSS 200/15	3250	4100	4700	6300	5850	5300
MSS 200/18	3450	4350	5000	6600	6150	5550
MSS 200/23	3750	4700	5400	7000	6500	5900
MSS 250/13	3800	4800	5550	7100	6600	6000
MSS 250/15	4000	5050	5800	7350	6850	6200
MSS 250/18	4250	5350	6150	7700	7150	6500
MSS 250/23	4600	5800	6650	8200	7600	6900
MSS 300/15	4800	6050	6950	8450	7850	7100
MSS 300/18	5100	6400	7350	8800	8200	7400
MSS 300/23	5500	6950	8000	9400	8700	7900
MSS 350/18	6100	7700	8800	10100	9400	8500
MSS 400/20	6700	8400	9650	10800	10050	9100
MSS 400/23	7000	8850	10100	11200	10400	9400

- a) Dead Load Deflection limited to 12.5mm, Live load Deflection Limited to 9mm, and combined G+0.7Q deflection limit of span/300
- b) For consideration of floor vibrations, the tabulated data is for single floor joists performance under applied midspan point load. Giving due consideration to load sharing under applied point load (i.e heel drop) the maximum span limits can be adopted. Refer to floor rigidity notes.
- c) For section buckling stresses and section properties, refer to MSS Purlin tables.

MSS SINGLE SPAN FLOOR JOISTS

DESIGN CASE 2

Total Floor Dead Load 1.0 kPa includes SDL

Floor Live Load 1.5 kPa

NOTE: Dead Load is typical for suspended floor with timber flooring with tiling, and gib ceiling on battens below.

MSS Section ^c	Dynamic Span Limits ^b			Spans (mm) for Joist Spacing Based on Strength and Stiffness ^a		
	Limit Deflection 1mm/1kN	Limit Deflection 2mm/1kN	Limit Deflection 3mm/1kN	300mm	400mm	600mm
MSS 150/12	2350	2950	3400	4700	4300	3750
MSS 150/15	2500	3200	3650	5050	4600	4050
MSS 150/18	2650	3350	3850	5350	4900	4300
MSS 150/23	2900	3650	4200	5800	5300	4650
MSS 200/12	3050	3800	4400	5950	5400	4750
MSS 200/15	3250	4100	4700	6300	5850	5200
MSS 200/18	3450	4350	5000	6600	6150	5550
MSS 200/23	3750	4700	5400	7000	6500	5900
MSS 250/13	3800	4800	5550	7100	6600	5950
MSS 250/15	4000	5050	5800	7350	6850	6200
MSS 250/18	4250	5350	6150	7700	7150	6500
MSS 250/23	4600	5800	6650	8200	7600	6900
MSS 300/15	4800	6050	6950	8450	7850	7100
MSS 300/18	5100	6400	7350	8800	8200	7400
MSS 300/23	5500	6950	8000	9400	8700	7900
MSS 350/18	6100	7700	8800	10100	9400	8500
MSS 400/20	6700	8400	9650	10800	10050	9100
MSS 400/23	7000	8850	10100	11200	10400	9400

a) Dead Load Deflection limited to 12.5mm, Live load Deflection Limited to 9mm, and combined G+0.7Q deflection limit of span/300

b) For consideration of floor vibrations, the tabulated data is for single floor joists performance under applied midspan point load. Giving due consideration to load sharing under applied point load (i.e heel drop) the maximum span limits can be adopted. Refer to floor rigidity notes.

c) For section buckling stresses and section properties, refer to MSS Purlin tables.

MSS SINGLE SPAN FLOOR JOISTS

DESIGN CASE 3

Total Floor Dead Load 0.5 kPa includes SDL

Floor Live Load 2.0 kPa

NOTE: Dead Load is typical for suspended residential balcony/deck structures with timber plywood flooring, membrane and allowance for soffit lining.

MSS Section ^c	Dynamic Span Limits ^b			Spans (mm) for Joist Spacing Based on Strength and Stiffness ^a		
	Limit Deflection 1mm/1kN	Limit Deflection 2mm/1kN	Limit Deflection 3mm/1kN	300mm	400mm	600mm
MSS 150/12	2350	2950	3400	4600	4300	3850
MSS 150/15	2500	3200	3650	4850	4500	4100
MSS 150/18	2650	3350	3850	5050	4700	4250
MSS 150/23	2900	3650	4200	5400	5000	4500
MSS 200/12	3050	3800	4400	5550	5200	4700
MSS 200/15	3250	4100	4700	5850	5450	4950
MSS 200/18	3450	4350	5000	6150	5700	5150
MSS 200/23	3750	4700	5400	6500	6050	5500
MSS 250/13	3800	4800	5550	6600	6150	5550
MSS 250/15	4000	5050	5800	6850	6400	5750
MSS 250/18	4250	5350	6150	7150	6650	6000
MSS 250/23	4600	5800	6650	7600	7100	6400
MSS 300/15	4800	6050	6950	7850	7300	6600
MSS 300/18	5100	6400	7350	8200	7650	6900
MSS 300/23	5500	6950	8000	8700	8100	7350
MSS 350/18	6100	7700	8800	9400	8750	7900
MSS 400/20	6700	8400	9650	10050	9350	8450
MSS 400/23	7000	8850	10100	10400	9700	8750

- a) Dead Load Deflection limited to 12.5mm, Live load Deflection Limited to 9mm, and combined G+0.7Q deflection limit of span/300
- b) For consideration of floor vibrations, the tabulated data is for single floor joists performance under applied midspan point load. Giving due consideration to load sharing under applied point load (i.e heel drop) the maximum span limits can be adopted. Refer to floor rigidity notes.
- c) For section buckling stresses and section properties, refer to MSS Purlin tables.

MSS SINGLE SPAN FLOOR JOISTS

DESIGN CASE 4

Total Floor Dead Load 1.0 kPa includes SDL

Floor Live Load 2.0 kPa

NOTE: Dead Load is typical for suspended residential balcony/deck structures with timber plywood flooring, tiles over membrane.

MSS Section ^c	Dynamic Span Limits ^b			Spans (mm) for Joist Spacing Based on Strength and Stiffness ^a		
	Limit Deflection 1mm/1kN	Limit Deflection 2mm/1kN	Limit Deflection 3mm/1kN	300mm	400mm	600mm
MSS 150/12	2350	2950	3400	4450	4050	3550
MSS 150/15	2500	3200	3650	4800	4400	3850
MSS 150/18	2650	3350	3850	5050	4650	4100
MSS 150/23	2900	3650	4200	5400	5000	4450
MSS 200/12	3050	3800	4400	5550	5150	4500
MSS 200/15	3250	4100	4700	5850	5450	4900
MSS 200/18	3450	4350	5000	6150	5700	5150
MSS 200/23	3750	4700	5400	6500	6050	5500
MSS 250/13	3800	4800	5550	6600	6150	5400
MSS 250/15	4000	5050	5800	6850	6400	5750
MSS 250/18	4250	5350	6150	7150	6650	6000
MSS 250/23	4600	5800	6650	7600	7100	6400
MSS 300/15	4800	6050	6950	7850	7300	6600
MSS 300/18	5100	6400	7350	8200	7650	6900
MSS 300/23	5500	6950	8000	8700	8100	7350
MSS 350/18	6100	7700	8800	9400	8750	7900
MSS 400/20	6700	8400	9650	10050	9350	8450
MSS 400/23	7000	8850	10100	10400	9700	8750

a) Dead Load Deflection limited to 12.5mm, Live load Deflection Limited to 9mm, and combined G+0.7Q deflection limit of span/300

b) For consideration of floor vibrations, the tabulated data is for single floor joists performance under applied midspan point load. Giving due consideration to load sharing under applied point load (i.e heel drop) the maximum span limits can be adopted. Refer to floor rigidity notes.

c) For section buckling stresses and section properties, refer to MSS Purlin tables.

FLOOR JOIST SPAN COMPARISONS

MSS SECTIONS AND NZS3604 MSG8 (400 C/C)

DESIGN CASE 1

Dead Load + SDL 0.5 kPa

Live Load 1.5 kPa

NOTE: Dead Load is typical for suspended floor with timber flooring, carpet, and gib ceiling on battens below.

Section (Timber MSG8 or Steel) MSG 8 Span data from NZS3604 Table 7.1. MSS section data from Span Table Design Case 1		Comparison with NZS3604
		Spacing 400mm
90 x 35	MSG8	1350
90 x 45	MSG8	1450
140 x 35	MSG8	2100
140 x 45	MSG8	2700
190 x 45	MSG8	3550
290 x 45	MSG8	4400
MSS 150	12	4600
MSS 150	15	4850
MSS 150	18	5050
290 x 45	MSG8	5200
MSS 150	23	5400
MSS 200	12	5550
MSS 200	15	5850
MSS 200	18	6150
MSS 200	23	6500
MSS 250	13	6600
MSS 250	15	6850
MSS 250	18	7150
MSS 250	23	7600
MSS 300	15	7850
MSS 300	18	8200
MSS 300	23	8700
MSS 350	18	9400
MSS 400	23	10400
MSS 400	20	10050

1) The above and following tables are based on span table data for MSG8 timber from NZS3604 table 7.1. (a).

2) For MSS section span data, the limiting span is taken as the limiting span determined by strength and deflection check from MSS Span Tables Design Case 1.

3) **IMPORTANT:** Designers must refer to MSS Floor Joist Design tables to ensure that appropriate level of vibration control is considered in adopting

the appropriate span limit for the section size and spacing adopted. Spans noted above for MSS sections will generally be lower when consideration for vibration control is considered.

4) Refer to design tables 1 to 4 for other notes relating to selection of MSS sections as floor joist members.

FLOOR JOIST SPAN COMPARISONS

MSS SECTIONS AND NZS3604 MSG8 (600 c/c)

DESIGN CASE 2

Dead Load + SDL 1.0 kPa

Live Load 1.5 kPa

NOTE: Dead Load is typical for suspended floor with timber flooring with tiling, and gib ceiling on battens below.

Section (Timber MSG8 or Steel) MSG 8 Span data from NZS3604 Table 7.1. MSS section data from Span Table Design Case 1		Comparison with NZS3604
		Spacing 600mm
90 x 35	MSG8	1200
90 x 45	MSG8	1250
140 x 35	MSG8	1800
140 x 45	MSG8	2000
190 x 45	MSG8	3150
240 x 45	MSG8	3900
MSS 150	12	4100
MSS 150	15	4400
MSS 150	18	4550
290 x 45	MSG8	4600
MSS 150	23	4850
MSS 200	12	5050
MSS 200	15	5300
MSS 200	18	5550
MSS 200	23	5900
MSS 250	13	6000
MSS 250	15	6200
MSS 250	18	6500
MSS 250	23	6900
MSS 300	15	7100
MSS 300	18	7400
MSS 300	23	7900
MSS 350	18	8500
MSS 400	20	9100
MSS 400	23	9400

1) The above and following tables are based on span table data for MSG8 timber from NZS3604 table 7.1. (a).

2) For MSS section span data, the limiting span is taken as the limiting span determined by strength and deflection check from MSS Span Tables Design Case 1.

3) **IMPORTANT:** Designers must refer to MSS Floor Joist Design tables to ensure that appropriate level of vibration control is considered in adopting

the appropriate span limit for the section size and spacing adopted. Spans noted above for MSS sections will generally be lower when consideration for vibration control is considered.

4) Refer to design tables 1 to 4 for other notes relating to selection of MSS sections as floor joist members.

FLOOR JOIST SPAN COMPARISONS

MSS SECTIONS AND NZS3604 MSG8 (400 C/C)

DESIGN CASE 3

Dead Load + SDL 0.5 kPa

Live Load 2.0 kPa

NOTE: Dead Load is typical for suspended residential balcony/deck structures with timber plywood flooring, membrane and allowance for soffit lining.

Section (Timber MSG8 or Steel) MSG 8 Span data from NZS3604 Table 7.1. MSS section data from Span Table Design Case 1		Comparison with NZS3604 Spacing 400mm
90 x 35	MSG8	1350
90 x 45	MSG8	1550
140 x 35	MSG8	2100
140 x 45	MSG8	2450
190 x 45	MSG8	3300
240 x 45	MSG8	4150
MSS 150	12	4300
MSS 150	15	4500
MSS 150	18	4700
MSS 150	23	5000
290 x 45	MSG8	5050
MSS 200	12	5200
MSS 200	15	5450
MSS 200	18	5700
MSS 200	23	6050
MSS 250	13	6150
MSS 250	15	6400
MSS 250	18	6650
MSS 250	23	7100
MSS 300	15	7300
MSS 300	18	7650
MSS 300	23	8100
MSS 350	18	8750
MSS 400	23	9350
MSS 400	20	9700

1) The above and following tables are based on span table data for MSG8 timber from NZS3604 table 7.1. (a).

2) For MSS section span data, the limiting span is taken as the limiting span determined by strength and deflection check from MSS Span Tables Design Case 1.

3) **IMPORTANT:** Designers must refer to MSS Floor Joist Design tables to ensure that appropriate level of vibration control is considered in adopting

the appropriate span limit for the section size and spacing adopted. Spans noted above for MSS sections will generally be lower when consideration for vibration control is considered.

4) Refer to design tables 1 to 4 for other notes relating to selection of MSS sections as floor joist members.

FLOOR JOIST SPAN COMPARISONS

MSS SECTIONS AND NZS3604 MSG8 (600 c/c)

DESIGN CASE 4

Dead Load + SDL 1.0 kPa

Live Load 2.0 kPa

NOTE: Dead Load is typical for suspended residential balcony/deck structures with timber plywood flooring, tiles over membrane.

Section (Timber MSG8 or Steel) MSG 8 Span data from NZS3604 Table 7.1. MSS section data from Span Table Design Case 1		Comparison with NZS3604 Spacing 600mm
90 x 35	MSG8	1100
90 x 45	MSG8	1250
140 x 35	MSG8	1750
140 x 45	MSG8	2000
MSS 150	12	3850
MSS 150	15	4100
MSS 150	18	4250
190 x 45	MSG8	2700
MSS 150	23	4500
MSS 200	12	4700
MSS 200	15	4950
240 x 45	MSG8	3400
MSS 200	18	5150
MSS 200	23	5500
MSS 250	13	5550
MSS 250	15	5750
290 x 45	MSG8	4100
MSS 250	18	6000
MSS 250	23	6400
MSS 300	15	6600
MSS 300	18	6900
MSS 300	23	7350
MSS 350	18	7900
MSS 400	20	8450
MSS 400	23	8750

1) The above and following tables are based on span table data for MSG8 timber from NZS3604 table 7.1. (a).

2) For MSS section span data, the limiting span is taken as the limiting span determined by strength and deflection check from MSS Span Tables Design Case 1.

3) **IMPORTANT:** Designers must refer to MSS Floor Joist Design tables to ensure that appropriate level of vibration control is considered in adopting

the appropriate span limit for the section size and spacing adopted. Spans noted above for MSS sections will generally be lower when consideration for vibration control is considered.

4) Refer to design tables 1 to 4 for other notes relating to selection of MSS sections as floor joist members.

Client: _____

Deliver to: _____

_____ Date Req.: _____ Int Ref No.: _____

Date: _____

HOLE POSITIONS - RUNNING DIMENSIONS FROM LEFT HAND END O/No.: _____



MARK: _____ NO. OFF: _____ LENGTH: _____ METRES: _____



MARK: _____ NO. OFF: _____ LENGTH: _____ METRES: _____



MARK: _____ NO. OFF: _____ LENGTH: _____ METRES: _____



MARK: _____ NO. OFF: _____ LENGTH: _____ METRES: _____

Purlin Size

HOLES: 14 18

ROUND SLOT

Bracing

STANDARD

CAMLOK™
(requires slotted holes)

Sag Rod

SIZE: 12 16

Ridge Ties

SIZE: 12 16

PITCH: _____

Notes

Packing Slip No.

Signature

Total Metres

BRANCHES

WHANGAREI

42-44 Rewa Rewa Road, Whangarei
09 470 0870
sales.whangarei@metalcraftroofing.co.nz

AUCKLAND EAST TAMAKI

26 Trugood Drive East Tamaki, Auckland
09 273 2820
sales.aucklandmanufacturing@metalcraftroofing.co.nz

HAMILTON

25 Sheffield Street, Hamilton
07 849 3807
sales.hamilton@metalcraftroofing.co.nz

NEW PLYMOUTH

218 De Havilland Drive, Bell Block, New Plymouth
06 755 2113
sales.newplymouth@metalcraftroofing.co.nz

PALMERSTON NORTH

76 Malden Street, Palmerston North
06 358 9149
sales.palmerston@metalcraftroofing.co.nz

HASTINGS

1454A Omahu Road, Hastings
06 873 9020
sales.hastings@metalcraftroofing.co.nz

WELLINGTON

201 Gracefield Rd, Seaview, Lower Hutt
04 566 2253
sales.wellington@metalcraftroofing.co.nz

CHRISTCHURCH

85 Columbia Ave, Hornby, Christchurch
03 349 7350
sales.christchurch@metalcraftroofing.co.nz

CROMWELL

20 McNulty Road, Cromwell
03 445 4180
sales.cromwell@metalcraftroofing.co.nz

AUCKLAND NORTH SHORE

4 Silverfield, Wairau Park, Glenfield, Auckland
09 444 1813
sales.auckland@metalcraftroofing.co.nz

TAURANGA

42 Poturi St, Tauriko, Tauranga
07 575 7032
sales.tauranga@metalcraftroofing.co.nz

ROTORUA

15 Monokia Street, Rotorua
07 350 1138
sales.rotorua@metalcraftroofing.co.nz

For more information on Metalcraft Roofing visit: www.metalcraftgroup.co.nz.
Metalcraft Roofing is part of United Industries Ltd. For more information on
United Industries visit: www.unitedindustries.co.nz.



www.metalcraftgroup.co.nz

