

Roof Window Fixed

The Keylite Fixed Skylight can be installed in any sloping roof with a pitch of 15°-90° making it a simple and cost-effective way of bringing natural light into a building.

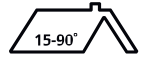

Features

- ▶ **Additional Security** - One of the many benefits of choosing a Keylite Fixed Roof Window is that it provides extra security to the occupants of the building.
- ▶ **Integrated Thermal Collar** - Unlike other Skylights Keylite's thermal collar is integrated into the frame. The collar is activated by simply pulling the release tabs for a fast insulation solution, combating cold bridging.
- ▶ **Flick-Fit Brackets** - Keylite's unique Flick-Fit brackets are pre fitted so you can lift the window straight from the box to the roof and simply select the setting for tile or slate.
- ▶ **Recessed Fit as standard** - Keylite windows all come recessed as standard sitting lower in the roof than before. No additional cost and Improved Thermal Performance as a result.
- ▶ **Appearance** - The Keylite Fixed Skylight is provided with all the same aesthetically pleasing features of one of our standard Skylights.
- ▶ **Low Profile Hood** - Keylite's new hood has a lower profile and features a more sculptured design, enhancing its appearance in the roof.
- ▶ **Glazing** – All Keylite Skylights are complete with a warm edge glazing unit as standard. This not only enhances the windows overall performance but also assists in reducing the occurrence of condensation. Furthermore Keylites glazing blocks approximately 80% of harmful radiant heat and approximately 95% of harmful UV rays.

Application

- ▶ Keylite recommend installing the window so that the frame bottom is no less than 1.85m above the floor.

Glazing

- ▶ Sun Guard (SG) – Double glazed 4mm toughened outer Sun Guard pane, 18mm argon gas filled cavity, 6mm laminated inner pane.

Finish

- ▶ Interior - White
- ▶ Exterior - Grey

Guarantee

- ▶ 10 Years – Keylite's hassle free guarantee on Skylights and flashings.
- ▶ 3 Years – Keylite's hassle free guarantee on blinds and accessories.

Maintenance

- ▶ The glazing pane of a Keylite Skylight can be cleaned with a soft, clean cloth/ chamois or non-metal squeegee. Clean water will be sufficient for cleaning the pane.



Thermal Performance

		Sun Guard (SG) Glazing Unit
Centre Pane U-Value	Ug [W/m²K]	1.1
Window U-Value	Uw [W/m²K]	1.4

Installation and Accessory Products

Flashings

Single Installation

- ▶ Deep Tile (DTRF)

Combination Installation

- ▶ Combi Tile (CTRF)
- ▶ Bi-Lite Tile (BLTRF)
- ▶ Quad Lite Tile (QLTRF)









Additional Installation Products

- ▶ Underfelt Collar (FC)
- ▶ Vapour Collar (VC)

Blinds

- ▶ Integral Blind (RWF-I)
- ▶ Black out Blind (RWF-BB)

Size Range

		Sizes (WxH)						
								
		550x780	550x980	780x980	780x1180	780x1400	1140x780	1140x1180
	White Finish	RWF-01	RWF-02	RWF-04	RWF-05	RWF-06	RWF-08A	RWF-08

*Please Note: Additional sizes may be available upon request, please contact the Keylite Technical Department for further information.

Glazing Option

Glazing Results			Sun Guard [SG]
UV	Transmittance	τ_{uv}	0.01
Light	Transmittance for standard illuminant D65	τ_v	0.50
	Reflectance for standard illuminant D65 (*) external	ρ^v	0.15
	For standard illuminant D65 (**) internal	ρ^v	0.14
	General colour rendering index	R_a	0.89
Energy	Solar direct transmittance	τ_e	0.20
	Solar direct reflectance (*) external	ρ_e	0.44
	Solar direct reflectance (**) internal	ρ_e	0.41
	Solar direct absorption (*)	a	0.36
	Secondary internal heat transfer factor (*)	q_i	0.03
	Solar heat gain coefficient (SHGC)	g	0.23
	Shading coefficient (+g_DIN/0,87)(*)	sc	0.26
Sound	Sound reduction (dB)	rw	37

Technical Information

Window Type	Window Size	External Frame Size		External Plasterboard		Glazing Size (mm)		Visible Glazing Size		Internal Plasterboard		Natural Daylight Area	Opening Size Required	
		W2	H2	W1	H1	X	Y	A	B	P1	P2		W	H
RWF	01	550	780	505	735	467	694	442	648	480	714	0.286	590	820
RWF	02	550	980	505	935	467	894	442	848	480	914	0.375	590	1020
RWF	04	780	980	735	935	697	894	672	848	710	914	0.570	820	1020
RWF	05	780	1180	735	1135	697	1094	672	1048	710	1114	0.704	820	1220
RWF	06	780	1400	735	1355	697	1314	672	1268	710	1334	0.852	820	1440
RWF	08A	1140	780	1095	735	1057	694	1032	648	1070	714	0.669	1180	820
RWF	08	1140	1180	1095	1135	1057	1094	1032	1048	1070	1114	1.082	1180	1220

Cross Sections

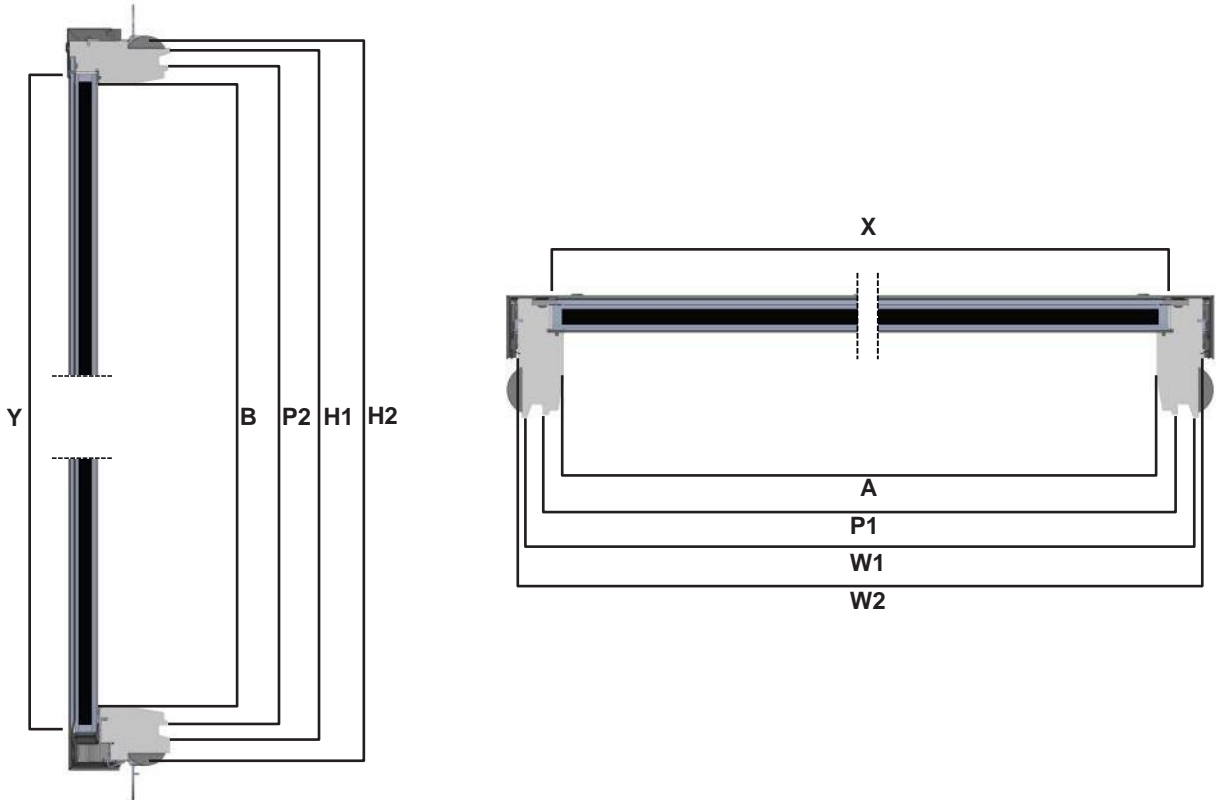

Keylite New Zealand Distribution

Adlux Industries Ltd
 36 Olive Rd
 Penrose
 Auckland

Customer Service: (09) 636 6866

Email: sales@adlux.co.nz