



# 7000 Series

Door furniture & deadbolts



Sleek sophistication is at your fingertips with the Schlage 7000 Series. This contemporary lever range has a distinctively European feel. Blending form with function, the Schlage 7000 Series will allow you to express your individuality with lasting integrity. Beautifully designed down to the last detail, this series is manufactured from high quality stainless steel for heightened durability, good looks and great feel. The Schlage 7000 Series has a round rose with solid and tubular levers to choose from.

## Features

- Constructed of quality components with solid or tubular stainless steel levers and die cast roses
- Built in privacy push-button for quick installation and ease of use
- The 7000 Series is suitable for use on fire door assemblies when used with fire rated mortice locks or latches
- Through bolts provide secure fixing, concealed by a round rose cover for aesthetic appeal
- Replaceable spring

## Specification guide

Function	Lever	Finish
Dummy trim .....7002	Albo solid .....713	Satin stainless steel ..... SSS
Latch furniture ..... 7000	Alpha solid .....715	
Passage set .....7005	Angelo solid .....714	
Privacy set ..... 7006	Dali solid .....712	
	Degas solid .....705	
	Dulag solid .....708	
	Gavarni solid .....711	
	Kahlo solid .....707	
	Katz solid .....710	
	Raphael solid .....706	
	Vargas solid .....701	
	Vinci solid .....702	
	Alpha tubular .....29-Ø19mm	
	Jordaens tubular .....16-Ø19mm	
	Diablo tubular .....15-Ø19mm	
	Diablo mitred tubular .....60-Ø19mm	





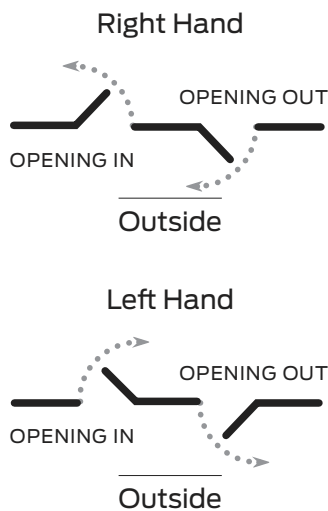

- Function  
Select the desired function e.g. Passage set ..... 7005/
- Lever  
Select the required lever design e.g. Dulag #708 ..... 7005/708
- Finish  
Select the desired finish e.g. Satin stainless steel ..... 7005/708SSS

## Handing guide



### Specifications

<b>Door type</b>	Timber or metal
<b>Door thickness</b>	Latch furniture 35mm to 50mm Passage set 35mm to 50mm Privacy set 32mm to 42mm
<b>Backset</b>	60mm or 70mm
<b>Spindle size</b>	7.6mm
<b>Compatible locks/ latches</b>	Tubular latches, ME Series mortice locks 990MF Series mortice locks
<b>Fixing</b>	Concealed through fixings
<b>Materials</b>	Solid or tubular stainless steel handles, die cast roses
<b>Finish</b>	Satin stainless steel
<b>Warranty</b>	7 year mechanical and finish when used on residential applications

Functions	Outside	Inside
<b>7002 - Dummy trim</b> Inactive lever which is used as a door pull or matching trim		
<b>7000 - Latch furniture</b> Two levers to be used with a latch, mortice lock or converted to dummy trim with fixing kit		
<b>7005 - Passage set (60mm or 70mm backset)</b> Both levers always unlocked		
<b>7006 - Privacy set (60mm or 70mm backset)</b> Push-button locks outside lever (outside emergency release). Inside lever unlocks door		

## 7000 Series solid stainless steel lever designs

**Albo #713**

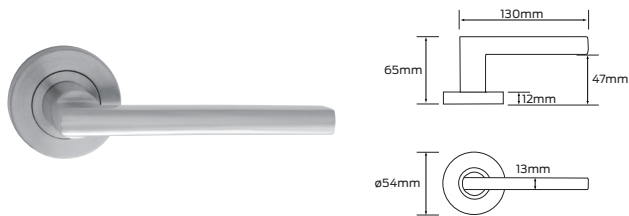

**Alpha #715**

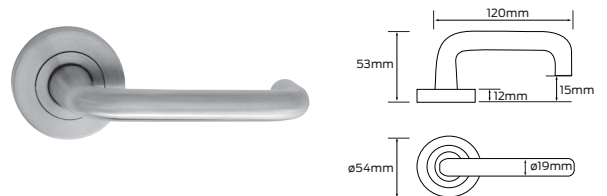

**Angelo #714**

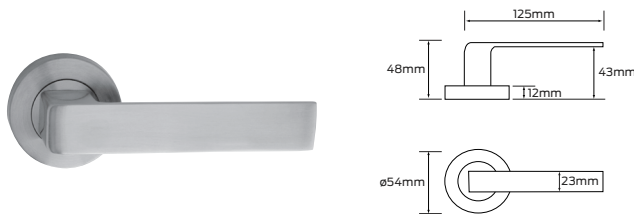

**Dali #712**

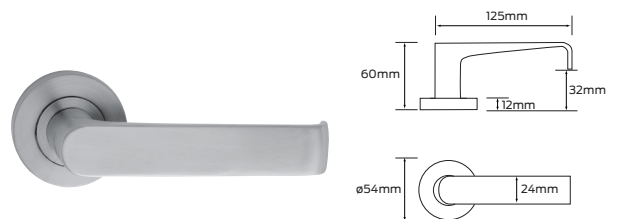

**Degas #705** 

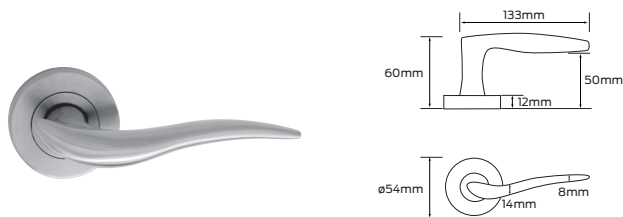

**Dulag #708**

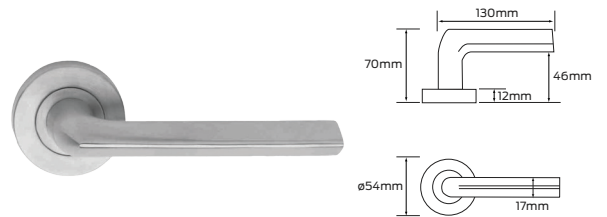

**Gavarni #711**

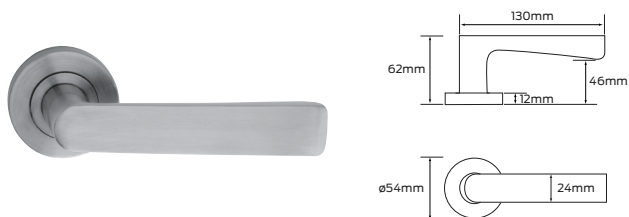

**Kahlo #707** 

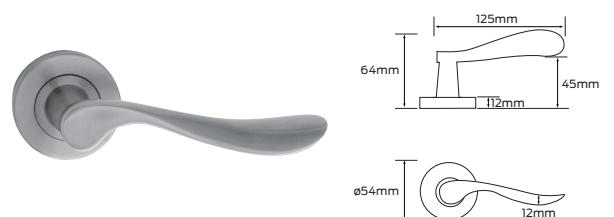

**Katz #710**

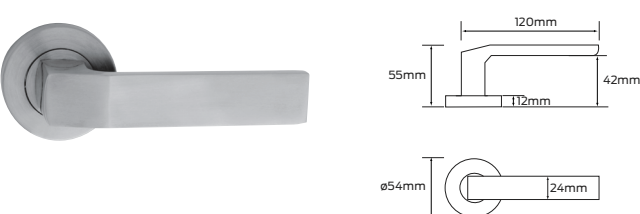

**Raphael #706** 

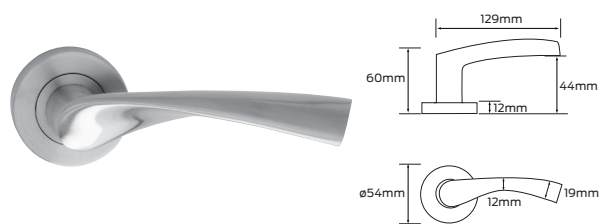

## 7000 Series solid stainless steel lever designs

Vargas #701

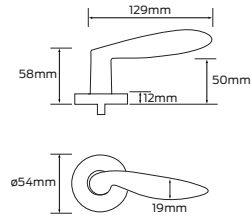

Vinci #702

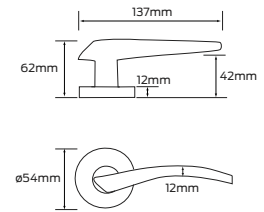

## 7000 Series tubular stainless steel lever designs

Alpha #29-Ø19mm

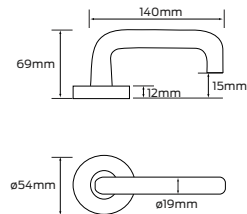
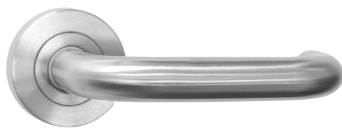

Jordaens #16-Ø19mm

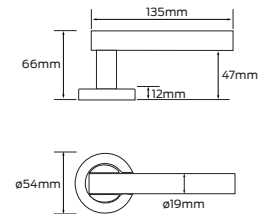
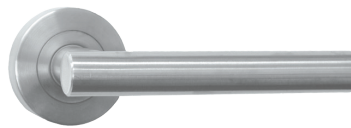

Diablo #15-Ø19mm

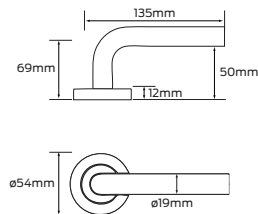
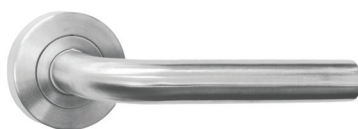

Diablo Mitred #60-Ø19mm

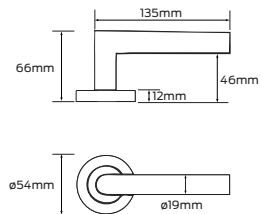
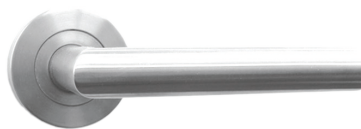

### Passage door preparation

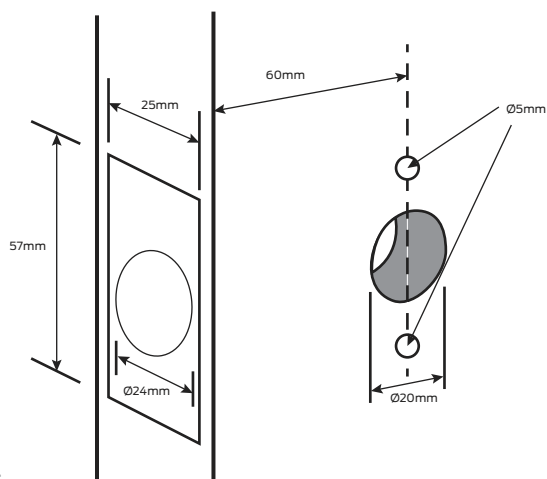

### Privacy door preparation

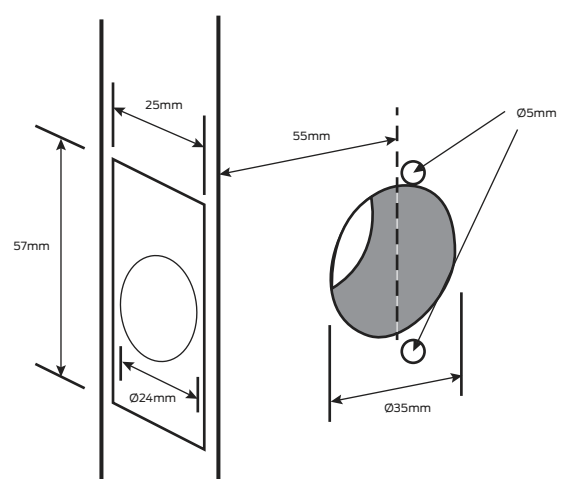

# 7000 Series escutcheons

**Turn #7007**

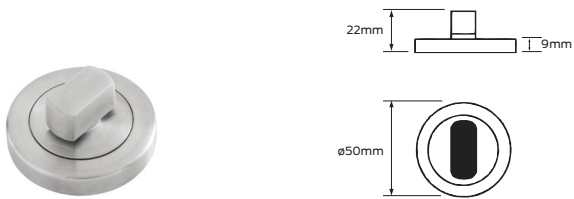

**Cylinder #7008**

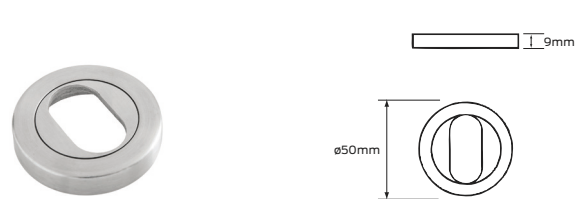

**Emergency release #7009**

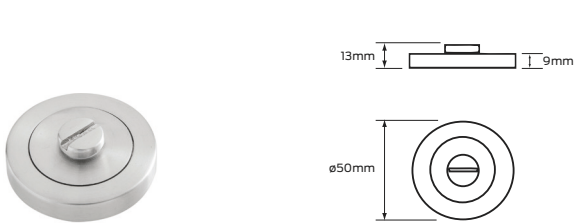

**Large turn #7010** 

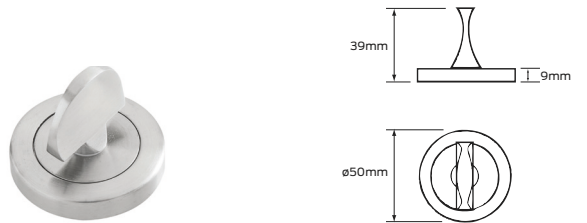

**Euro profile cylinder #7012**

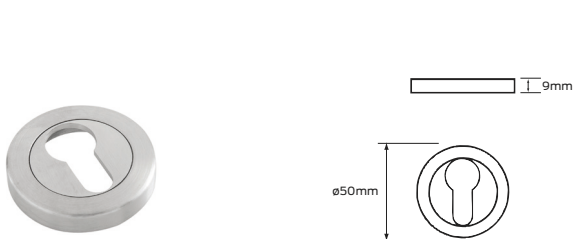

**Indicating turn #7013**

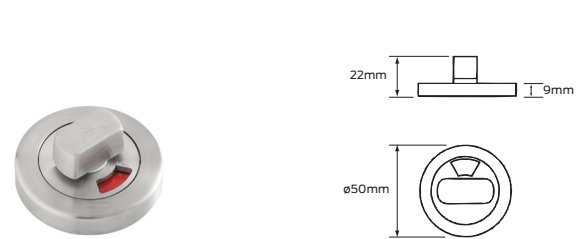

**Indicating emergency release #7014**

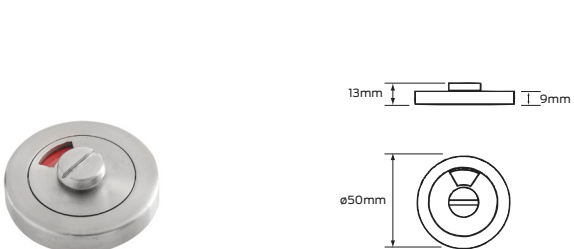

**Indicating large turn #7015** 

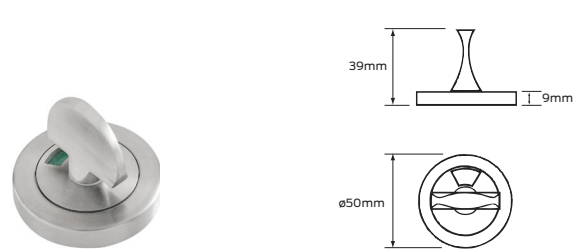

## 7000 Series accessories

### Passage latch

60mm backset  
**Finishes:** Chrome plate, satin chrome plate

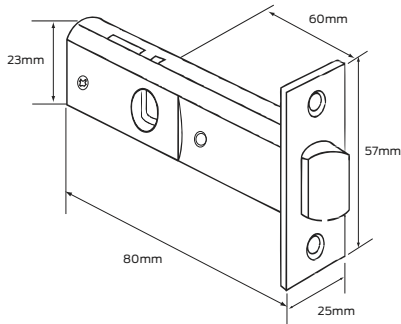

### Privacy latch

60mm backset  
**Finishes:** Chrome plate, satin chrome plate

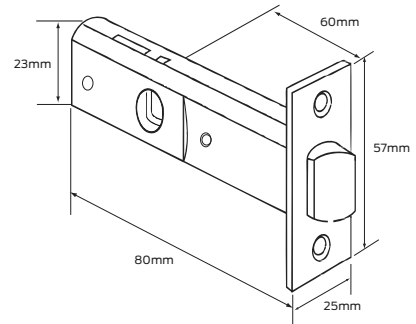

### Passage latch

70mm backset  
**Finish:** Satin stainless steel

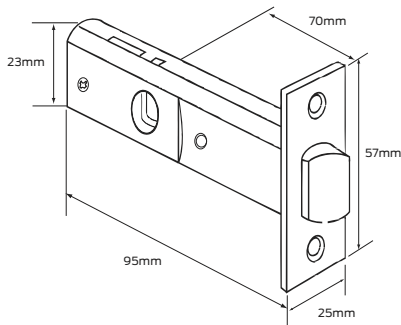

### Privacy latch

70mm backset  
**Finish:** Satin stainless steel

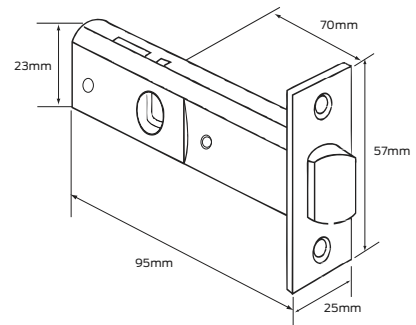

### Dummy trim fixing kit

Allows conversion of lever furniture to dummy trim function.  
 One kit required per lever

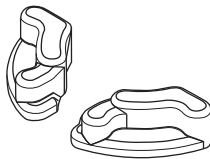

### Rose caps

Available to mix and match finishes with levers  
**Finish:** Satin stainless steel

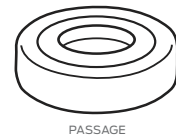

PASSAGE

### Universal rebate kit

**Finish:** Satin chrome plate

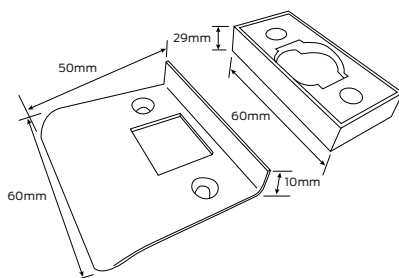

### Emergency turn set

Turn escutcheon, emergency release escutcheon and deadbolt  
**Finish:** Satin stainless steel

