

Metal Plate

Product Overview Catalogue



**Robust.
Reliable.
Safe.**

clipsal.com

CLIPSAL[®]

by Schneider Electric



ELECTRICAL ACCESSORIES

Metal Plate

Overview

Established in 1920, Clipsal by Schneider Electric is Australia's number one brand of electrical products, accessories and solutions for the residential, data, industrial, home control and management markets. Throughout our history, Clipsal has evolved and grown from its Adelaide base with great success by supporting our local economy and providing products manufactured at multiple sites across Australia. In our role as an industry leader, Clipsal is dedicated to supplying you with the most innovative and sustainable solutions available. As part of Schneider Electric, the global specialist in energy management, Clipsal provides a total electrical solution for any project or application.

clipsal.com

Metal Plate

The Clipsal Metal Plate range is designed to accommodate the needs of the high-end residential and commercial markets. Available in stainless steel and polished brass, with the options of 'A' (curved) and 'B' (flat) styles, as well as many custom made formats. The Metal Plate range offers a comprehensive selection to meet any project specifications, and is the ideal choice for premium metal switch and power outlet solutions.



Approvals and Certification

To assist meeting particular requirements, a selection of products from the Clipsal Standard range has been approved by The Department Of Energy, South Australia, and carry the Approval Mark S/1.

Metal Plate

Product Range

Clipsal's extensive Metal Plate range of switches and power outlets are available in a selection of stainless steel and brass models to suit every application. The stainless steel models provide a premium, stylish finish that is ideal for today's modern architectural interiors, while the brass models are available in a polished lacquered finish that beautifully complements a more traditional interior.

Both stainless steel and brass models offer the option of either 'A' or 'B' style plates. 'A' style plates have curved edges, providing a similar appearance to Clipsal Standard products, and 'B' style plates have a low profile appearance that is suitable for a wide range of applications.

For high security applications, Clipsal also offers robust Metal Plate Security Solutions, that provide innovative options, such as tamper proof screws and lockable outlets. So, if you require metal plate switches or power outlets look no further than Clipsal's Metal Plate range.

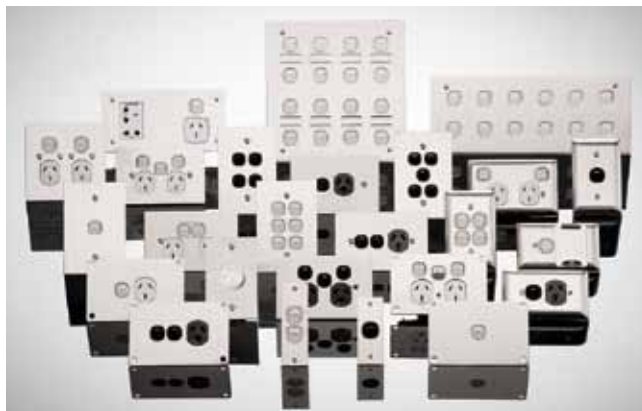

Stainless Steel Solutions

Switches and sockets with a stylish, premium metal finish.



Polished Brass Solutions

Switches and sockets to complement traditional decors, with a touch of class.



Security Solutions

When security is required for areas that can be subjected to vandalism, Clipsal Metal Plate Security Range is the best choice.

Contents

■ Page 8

Styles, Finishes & Colour Options

Styles, Plate Finishes, Grid Colours

■ Page 20

How to Order

Switches, Architrave Switches, Grids with Cover Plates, Multi-Gang Switch Panels, Socket Outlets

■ Page 32

Custom Made Products

Oversized Plates, Segregation of Services, Surface Mount, Prestige, Lockable Doors, Key Switches, Fasteners (Screws), Additional Plate Fixings, Optional Screw Lengths, Metal Plate Security Range

■ Page 44

Product Details

Flush Switches, Architrave Flush Switches, Grid Plates with Fascias, Multi-Gang Switch Assemblies, Multi-Gang Switch Assemblies - Labelling Options, Message Mechanisms, Multi-Gang Wall Boxes, Switched Socket Outlets, Mounting Accessories & Spacers, Switch Mechanisms, Safety & Cleaning Guidelines

■ Page 94

Wiring & Connection Diagrams

To assist with electrical connections, wiring diagrams of popular switches, dimmers and fan controllers.

■ Page 106

Medilec Range

Bedhead Panels, Medi-Plus Series, ESP Series

■ Page 110

Alternative Products with Metal Finishes

2000 Series, Classic C2000, Slimline, Eclipse, Saturn, Strato, Modena, Heritage, Prestige, Neo, DLT, Touch Screens, Reflection, Cable Management Systems, Lighting, Ceiling Sweep Fans

■ Page 118

Quick Reference Guide

Mounting Accessories Cross Reference Guide, Alpha Numeric Key for Mounting Accessories, Quick Reference Guide.

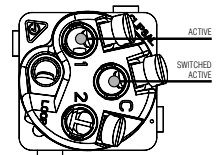
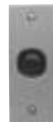

Metal Plate

Styles, Finishes & Colour Options



Styles

Clipsal's Metal Plate range offers virtually unlimited possibilities. The stainless steel switches and power outlets look superb in today's modern kitchens, while the polished brass range beautifully complements more traditional decors.

Incorporating stylish design and superior durability, the Metal Plate Range will add a touch of class to both residential and commercial interiors.

As the most comprehensive metal plate range in Australia, Clipsal offers a choice of lacquered polished brass and stainless steel finishes. The Metal Plate Range is available in two distinct styles; 'A' (curved) style and 'B' (flat) style.

'A' Style

- Curved edges, providing a similar appearance to Clipsal Standard range products.
- Prestigious metal plate for upmarket installations.
- Smooth yet sharp appearance will add a touch of class to any installation.
- Available with up to four switches or as a switched socket outlet in both vertical and horizontal formats.
- These plates have a 13mm profile (refer to Quick Reference Guide at rear of brochure for dimensions).





A25A-WE

Pictured: Stainless Steel

AVAILABLE PLATE COLOURS

Standard Colours

-  Polished Brass
-  Stainless Steel

Metal Plate

Styles, Finishes & Colour Options

'B' Style

- 'B' style plates are flat, durable and add a professional look to any installation.
- Most commonly installed in modern homes, hospitals, schools, prisons and other commercial areas.
- 'B' style plates are available in architrave and standard size switches, socket outlets and multi-gang assemblies.
- These plates have a 1.6mm profile (refer to Quick Reference Guide at rear of brochure for dimensions).





B15V2A-WE



Pictured: Stainless Steel

AVAILABLE PLATE COLOURS

Standard Colours

-  Polished Brass
-  Stainless Steel

Non-Standard Colours

-  Anodised Aluminium
-  Powder Coated
-  Mirrored

'BSL' Style

- Incorporates a combination of the Slimline, Classic and C-Bus grids. Clipsal has modernised the look of the 'B' style range to create a contemporary design.
- The twin switched sockets have centrally located switches for easier access.
- The plate size has been increased to 130mm x 85mm, so that switches and socket outlets are uniform.
- The 'BSL' range combines the prestige 'B' style design with the modern look of Slimline.
- The 1.2mm plate profile, makes it the lowest profile plate in today's market (refer to Quick Reference Guide at rear of brochure for dimensions).





BSL25A-WE



Pictured: Stainless Steel

AVAILABLE PLATE COLOURS

Standard Colours

-  Polished Brass
-  Stainless Steel

Non-Standard Colours

-  Anodised Aluminium
-  Powder Coated
-  Mirrored

Metal Plate

Styles, Finishes & Colour Options

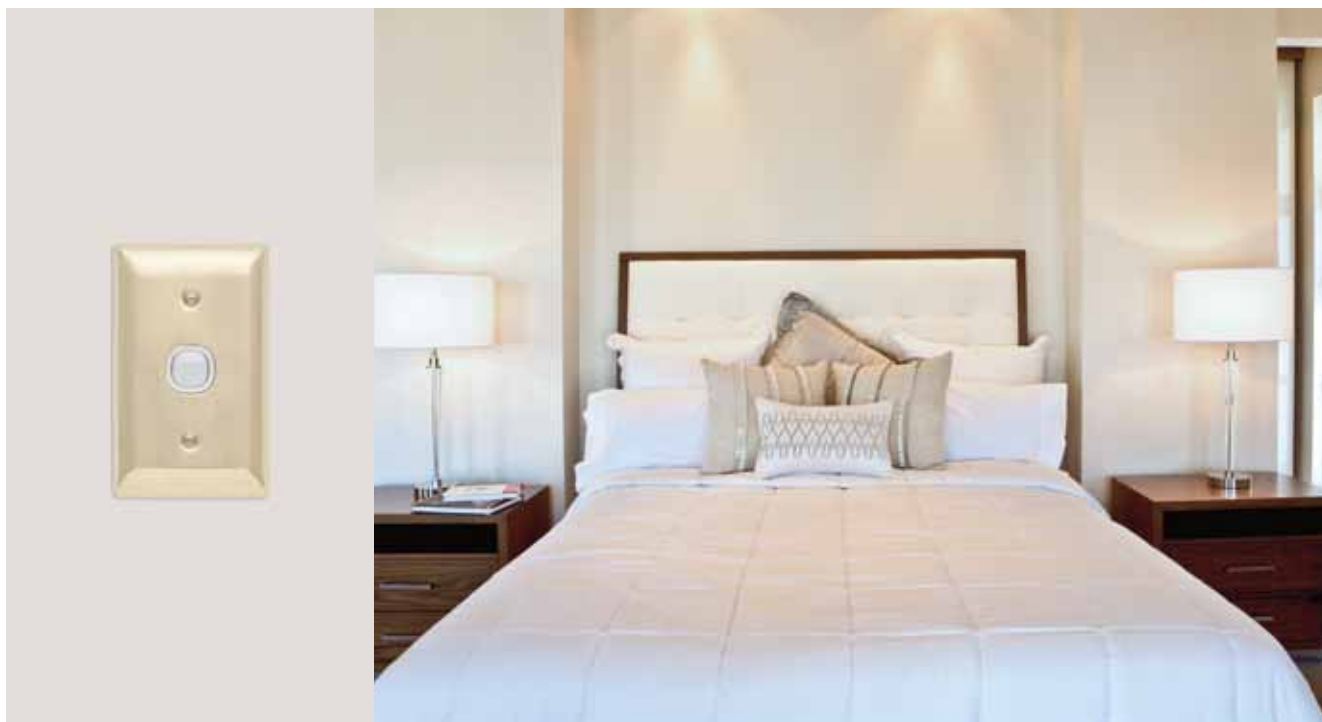

Plate Finishes

Clipsal's Metal Plate range is available in two standard plate finishes of polished brass or stainless steel.

The polished brass finish complements traditional decors and is not out of place in environments that require a touch of class to 'lift' existing finishes. Alternatively, the popular stainless steel finish is ideal for contemporary settings, such as offices, kitchens or bathrooms.

If the standard options are not suitable, Clipsal can provide other finishes. Anodised aluminium is available to special order for 'A', 'B' and 'BSL' styles, and powder coated or mirrored finishes are available in the 'B' and 'BSL' styles.

Stainless Steel

- The stainless steel plate finish is available for all plate styles, including multi-gang assemblies.
- Manufactured in 304 grade stainless steel, with a No.4 finish.
- Perfect for use in stainless steel kitchens, commercial offices and other areas where a sleek, modern finish is desired.



A31VA-WE

Pictured: Stainless Steel

Polished Brass

- Available in 'A' and 'B' styles for all products.
- Also available in a limited range of multi-gang assemblies.
- This finish is great for period homes or traditional hotels, providing a sophisticated look.
- To order polished brass finish, simply prefix the standard Catalogue Number used in the stainless steel range with the letter 'B' ('B' for brass). For example: BSL25A becomes BBSL25A.





BB5L31VA-WE



Pictured: Polished Brass

AVAILABLE PLATE COLOURS

Standard Colours

-  Polished Brass
-  Stainless Steel

Non-Standard Colours

-  Anodised Aluminium
-  Powder Coated
-  Mirrored

Note: powder coated or mirrored finishes are available in B or BSL style. only.

Metal Plate

Styles, Finishes & Colour Options

Other Finishes

- Anodised aluminium, powder coated and mirror finishes are available to special order.
- For anodised aluminium, prefix the metal plate catalogue number with the letter 'A' (e.g. ABSL25A).
- For powder coating, specify a Dulux colour. Note: not all powder coat colours are available.
- The mirrored option is a No.8 finish, which is the most reflective finish offered globally by the American Society for Testing and Materials (ASTM) standards.



Pictured: Anodised Aluminium





Pictured: Powder Coated Finish, Dulux Whisper White





Pictured: Mirror Finish

AVAILABLE PLATE COLOURS

Standard Colours

-  Polished Brass
-  Stainless Steel

Non-Standard Colours

-  Anodised Aluminium
-  Powder Coated
-  Mirrored

Note: powder coated or mirrored finishes are available in B or BSL style. only.

Grain Direction

- All stainless steel plates have 'grain direction' running vertically, on both horizontal and vertical orientated plates (unless otherwise specified).

Note: mechanisms may be removed and turned 90 degrees to change from horizontal to vertical orientation.

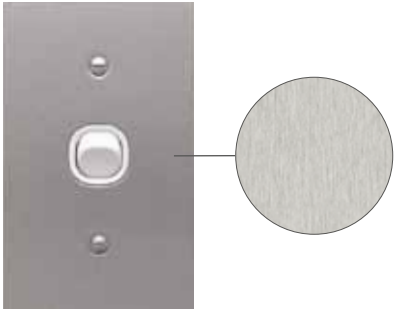

Pictured: vertical grain direction

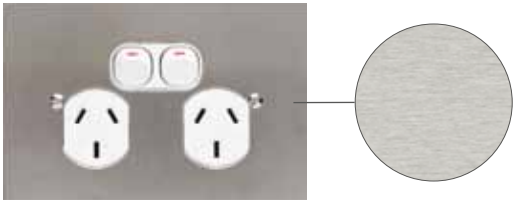

Pictured: horizontal grain direction

AVAILABLE PLATE COLOURS

Standard Colours

- Polished Brass
- Stainless Steel

Non-Standard Colours

- Anodised Aluminium
- Powder Coated
- Mirrored

Note: powder coated or mirrored finishes are available in B or BSL style. only.

Metal Plate

Styles, Finishes & Colour Options



Grid Colours

When ordering switch or socket outlets, grid colour variations also have to be taken into consideration because the grid assemblies are visible through the front cover plate. Metal Plate socket outlets have grid assemblies that are available in White Electric (WE), Black (BK) and Brown (BR). Other grid colours may be available through special order.

The grid assembly's colour is abbreviated by the last two letters of the catalogue number. The general catalogue number and colour is also separated by a dash. For example, the Catalogue Number for an 'A' style Twin Switched Socket Outlet with Stainless Steel cover and Black grid assembly is A25A-BK. The Catalogue Number for a 'BSL' style One-Gang Switch with Stainless Steel cover and White grid is BSL31VA-WE.

Note: all grid assemblies are made of a plastic that is chemically resistant, making the Metal Plate range ideal for installations where chemicals such as cleaning agents are present.

White Grid



A31VA-WE
Pictured: Stainless Steel



A25A-WE
Pictured: Stainless Steel



BSL31VA-WE
Pictured: Stainless Steel



BSL25A-WE
Pictured: Stainless Steel



BBSL31VA-WE
Pictured: Polished Brass

AVAILABLE GRID COLOURS

- Grid Colours
- White Electric
 - Black
 - Brown

The final letters after the dash indicate the grid plate and/or switch colour code:
WE - White Electric
BK - Black
BR - Brown

A 2 5 A - BK

Metal Plate

Styles, Finishes & Colour Options

Black Grid



A31VA-BK

Pictured: Stainless Steel



A25A-BK

Pictured: Stainless Steel



BSL31VA-BK

Pictured: Stainless Steel



BSL25A-BK

Pictured: Stainless Steel



BA31VA-BK

Pictured: Polished Brass

AVAILABLE GRID COLOURS

Grid Colours

- White Electric
- Black
- Brown

The final letters after the dash indicate the grid plate and/or switch colour code:

- WE - White Electric
- BK - Black
- BR - Brown

A 2 5 A - BK

Brown Grid



BA31VA-BR

Pictured: Polished Brass



BA25A-BR

Pictured: Polished Brass



BBSL31VA-BR

Pictured: Polished Brass



BBSL25A-BR

Pictured: Polished Brass

AVAILABLE GRID COLOURS

Grid Colours

- White Electric
- Black
- Brown

The final letters after the dash indicate the grid plate and/or switch colour code:

- WE - White Electric
- BK - Black
- BR - Brown

A 2 5 A - BK

Metal Plate

How to Order



Switches

The Clipsal Metal Plate range utilises 30 Series Switch Mechanisms, which have a patented design and trademark of Clipsal. Metal Plate switches in 'A' style and 'B' style are supplied with standard size fascia plates (115mm x 70mm) in one-gang through to four-gang formats. However, the 'BSL' style is an oversized version of 'B' style plates, supplied with 130mm x 85mm fascia plates in one-gang through to six-gang.

Explanation of Prefixes

Each range of switch and socket outlets have different prefixes at the beginning of the Catalogue Number. For Metal Plate products, the prefix is either 'A', 'BA', 'B', 'BB', 'BSL' or 'BBSL'. This depends on whether the product is 'A', 'B' or 'BSL' style in polished brass or stainless steel.

Prefixes at a Glance

Prefix	Dimensions (L x W x D)	Colour	Shape
A	115mm x 70mm x 10mm to 13mm	Stainless Steel	A Style
BA	115mm x 70mm x 10mm to 13mm	Polished Brass	A Style
B	115mm x 70mm x 1.6mm	Stainless Steel	B Style
BB	115mm x 70mm x 1.6mm	Polished Brass	B Style
BSL	130mm x 85mm x 1.2mm	Stainless Steel	BSL Style
BBSL	130mm x 85mm x 1.2mm	Polished Brass	BSL Style

Note: depth indicates face plate only.

'A' Style

Dimensions: L155mm x W70mm x D10mm to 13mm (external profile).

One-Gang

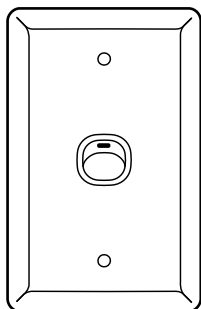

A31VA
Stainless Steel

BA31VA
Polished Brass

Two-Gang

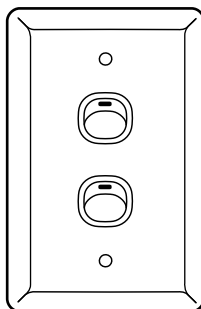

A32VA
Stainless Steel

BA32VA
Polished Brass

Three-Gang

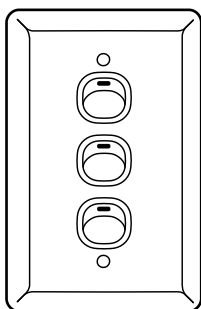

A33VA
Stainless Steel

BA33VA
Polished Brass

Four-Gang

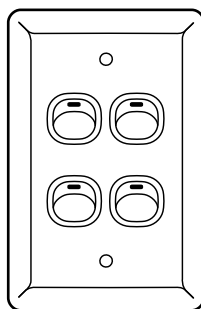

A34VA
Stainless Steel

BA34VA
Polished Brass

CATALOGUE NUMBER GUIDE

When prefixed with the letter 'A' this indicates that the product is 'A' style and cover is stainless steel.

BA 3 4 VA -WE

The letters 'BA' indicate that the product is 'A' style and that the cover is brass.

The number '3' indicates that the product is switch related.

This number indicates the amount of switch mechanisms included in the product.

The letters 'VA' indicate that the product is vertically assembled.

Colour reference of grid colours (e.g. WE is White Electric).

Note: colour reference is separated by a dash from the catalogue number prefix.

Metal Plate

How to Order

'B' Style

Dimensions: L115mm x W70mm x D1.6mm (face plate).

'BSL' Style

Dimensions: L130mm x W85mm x D1.2mm (face plate).

One-Gang

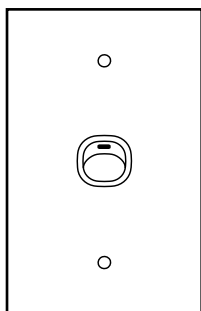

BSL31VA
Stainless Steel

BBSL31VA
Polished Brass

Two-Gang

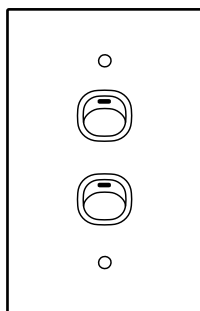

BSL32VA
Stainless Steel

BBSL32VA
Polished Brass

Three-Gang

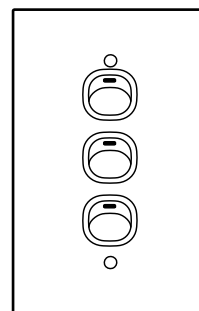

BSL33VA
Stainless Steel

BBSL33VA
Polished Brass

CATALOGUE NUMBER GUIDE

When prefixed with the letter 'BSL' this indicates that the product is 'BSL' style and cover is stainless steel.

BSL **3** **4** **VA** **-WE**

The letters 'BBSL' indicate that the product is 'BSL' style and that the cover is brass.

The number '3' indicates that the product is switch related.

This number indicates the amount of switch mechanisms included in the product.

The letters 'VA' indicate that the product is vertically assembled.

Colour reference of grid colours (e.g. WE is White Electric).

Note: colour reference is separated by a 'dash' from the catalogue number prefix.

Four-Gang

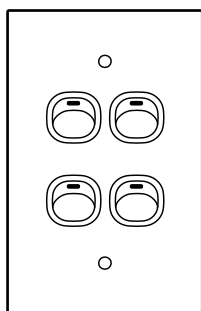

BSL34VA
Stainless Steel

BBSL34VA
Polished Brass

Five-Gang

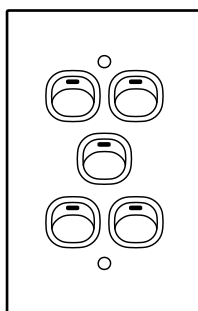

BSL35VA
Stainless Steel

BBSL35VA
Stainless Steel

Six-Gang

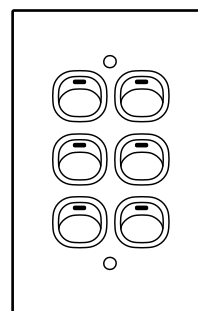

BSL36VA
Stainless Steel

BBSL36VA
Stainless Steel

CATALOGUE NUMBER GUIDE

When prefixed with the letter 'BSL' this indicates that the product is 'BSL' style and cover is stainless steel.

BSL **3** **4** **VA** **-WE**

The letters 'BBSL' indicate that the product is 'BSL' style and that the cover is brass.

The number '3' indicates that the product is switch related.

This number indicates the amount of switch mechanisms included in the product.

The letters 'VA' indicate that the product is vertically assembled.

Colour reference of grid colours (e.g. WE is White Electric).

Note: colour reference is separated by a 'dash' from the catalogue number prefix.

Metal Plate

How to Order



Architrave Switches

Metal Plate architrave switches are available in one, two and three-gang formats ('B' style only). All three architrave switch models come in different sizes.

Metal Plate architrave dimensions

Catalogue No.	Length	Width	Depth
B31A	89mm	35mm	1.6mm
B32A	109mm	35mm	1.6mm
B33A	139mm	35mm	1.6mm

Note: total depth is 30mm into the wall and face plate is 1.6mm.

Architrave Switches - Available in 'B' Style Only

One-Gang

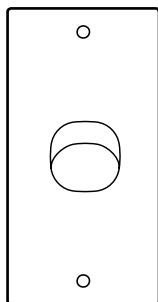

B31A
Stainless Steel

BB31A
Polished Brass

Two-Gang

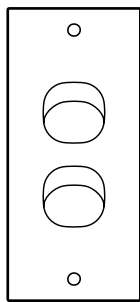

B32A
Stainless Steel

BB32A
Polished Brass

Three-Gang

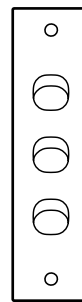

B33A
Stainless Steel

BB33A
Polished Brass

CATALOGUE NUMBER GUIDE

When prefixed with 'B' this indicates the product is 'B' style and cover is stainless steel.

BB **3** **3** **A** **-BK**

When prefixed with 'BB' this indicates the product is 'B' style and cover is brass.

The number '3' indicates that the product is switch related.

This number indicates the amount of switch mechanisms included in the product.

The final letter 'A' indicates that the product is assembled (vertically) in architrave format.

Colour reference of switch colours (e.g. BK is Black).

Note: colour reference is separated by a 'dash' from the catalogue number prefix.

Metal Plate

How to Order



Grids with Cover Plates (Less Mechanisms)

Metal Plate Switches in 'BSL' or 'BBSL' style can be supplied without mechanisms, which is ideal for projects that require specific 30 Series Mechanisms (e.g. fluorescent loads, message mechanisms or data jacks).

When ordering these products it is important to indicate what colour plate bezels will be required so that they match the colour of the mechanisms when they are inserted. For example: a vertical stainless steel switch plate with a white bezel (to match separately purchased white switch mechanisms), is ordered by requesting BSL31VH-WE.

Grids with Cover Plates (Less Mechanisms) - 'BSL' Style

One-Gang

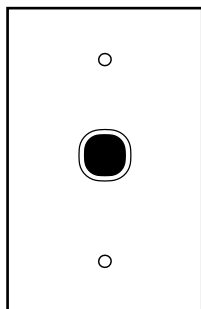

BSL31VH
Stainless Steel

BBSL31VH
Polished Brass

Two-Gang

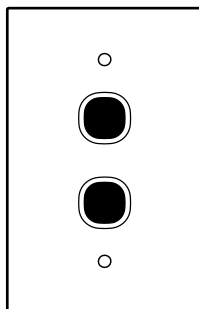

BSL32VH
Stainless Steel

BBSL32VH
Polished Brass

Three-Gang

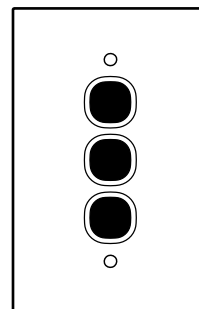

BSL33VH
Stainless Steel

BBSL33VH
Polished Brass

Four-Gang

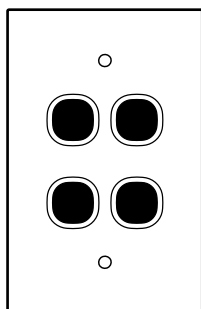

BSL34VH
Stainless Steel

BBSL34VH
Polished Brass

Five-Gang

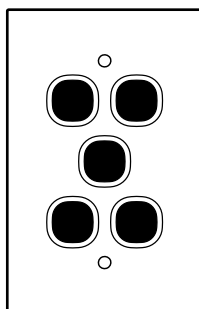

BSL35VH
Stainless Steel

BBSL35VH
Polished Brass

Six-Gang

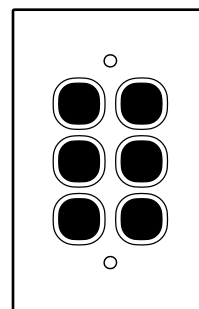

BSL36VH
Stainless Steel

BBSL36VH
Polished Brass

CATALOGUE NUMBER GUIDE

When prefixed with 'BSL' this indicates the product is 'BSL' style and cover is stainless steel.

BSL **3** **4** **VH** **-WE**

The letters 'BBSL' indicate that the product is 'BSL' style and that the cover is brass.

The number '3' indicates that the product is switch related.

This number indicates the amount of switch mechanisms included in the product.

The letters 'VH' indicates that the product can be vertically or horizontally orientated.

Indicates colour of exposed mechanism bezel (e.g. WE is White Electric).

Note: colour reference is separated by a 'dash' from the catalogue number prefix.

Metal Plate

How to Order



Multi-Gang Switch Panels

The Metal Plate range also provides multi-gang switch panels in configurations that can accommodate up to 72 mechanisms as standard units. They are all provided with 'B' style 1.6mm fascia panels without mechanisms. All flush plate finishing is vertical unless otherwise specified.

Please note: the Catalogue Numbers listed include the stainless steel cover plate, grid assembly, wall box, mounting clips and all screws. As standard, mechanisms are not included and labelling must be requested if required. There are various other multi-gang switch panels that can be custom built for specific projects. In these situations it is best to contact your Clipsal Representative or your local Clipsal Office.

Please refer to pages 60 to 65 for information on wall boxes.

Special thanks to Kooyonga Golf Club in South Australia for the use of their venue to photograph the multi-gang products shown.

Four-Gang

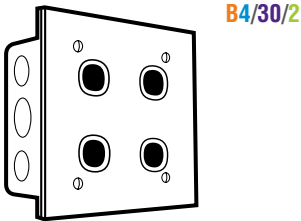

Six-Gang

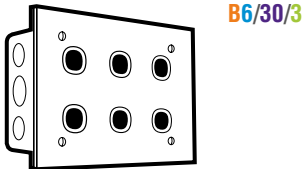

Eight-Gang

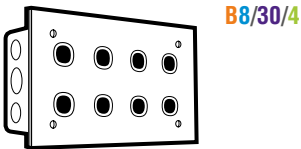

Ten-Gang

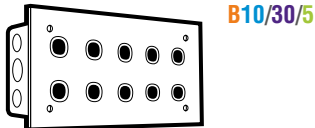

Twelve-Gang Labelled

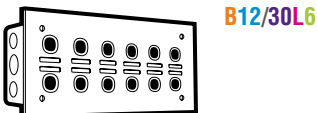

Sixteen-Gang

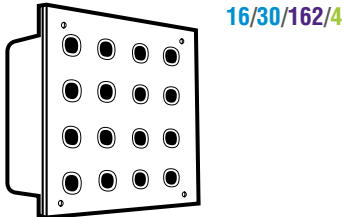

CATALOGUE NUMBER GUIDE

When prefixed with the letter 'B' this indicates the product is 'B' style and cover is stainless steel.

If product is not prefixed with 'B', the product will still be 'B' style stainless steel as standard.

The number following the 'B' or prefixing the Catalogue Number indicates the amount of switch apertures.

The number '30' indicates that the product is switch related.

The letter 'L' indicates that the product is labelled (if no 'L' is shown, product is unlabelled).

The last number indicates the amount of vertical switch columns.

Indicates colour of exposed bezel (e.g. WE is White Electric).



A 162, 163 or 164 series number indicates the product is supplied with this style of wall box. If catalogue number does not include either of these numbers, the product is supplied with the 164 series wall box as standard.

Note: colour reference is separated by a dash from the catalogue number prefix.

Metal Plate

How to Order

Socket Outlets

Switched socket outlets are often referred to as GPOs (general purpose outlets), power points or power outlets. To avoid confusion, the description 'switched socket outlets' will be used throughout this brochure.

Single and twin switched socket outlets are available in horizontal and vertical formats. Catalogue Numbers will vary depending on the number of sockets and whether the product is horizontally or vertically mounted.

'A' Styles

Single/Vertical

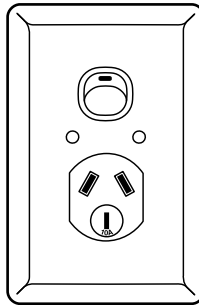

A15VA
Stainless Steel

BA15VA
Polished Brass

Single/Horizontal

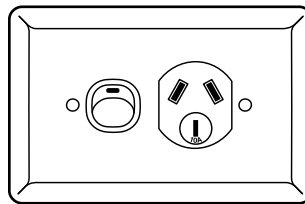

A15A
Stainless Steel

BA15A
Polished Brass

Twin/Horizontal

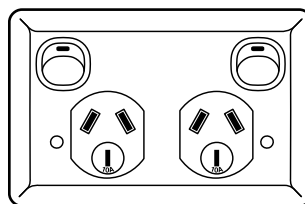

A25A
Stainless Steel

BA25A
Polished Brass

CATALOGUE NUMBER GUIDE

When prefixed with the letter 'A', this indicates that the product has an 'A' style shape with a stainless steel cover.

When prefixed with the letters 'BA', this indicates the product has an 'A' style shape with a brass cover.

The number indicates the number of sockets included in the product.

The number '5' indicates that the product is a socket outlet.

The letter 'V' indicates that the product is vertically assembled (if no 'V' is shown, product is horizontally assembled).

Colour reference of grid colours (e.g. BK is Black).



Note: colour reference is separated by a dash from the catalogue number prefix.

'B' and 'BSL' Styles

Single/Vertical

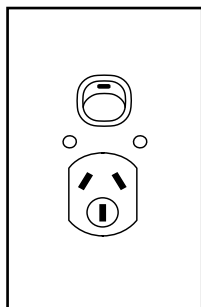

B15VA
Stainless Steel

BB15VA
Polished Brass

Twin/Square

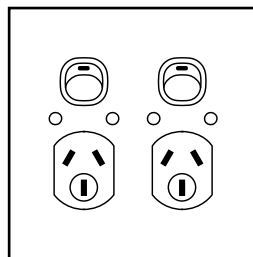

B15V2A
Stainless Steel

BB15V2A
Polished Brass

Single/Horizontal

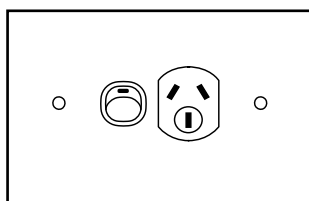

BSL15A
Stainless Steel

BBSL15A
Polished Brass

Twin/Horizontal

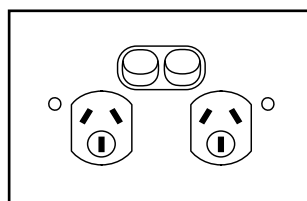

BSL25A
Stainless Steel

BBSL25A
Polished Brass

CATALOGUE NUMBER GUIDE

When prefixed with 'B' or 'BSL' this indicates the product is 'B' or 'BSL' style and cover is stainless steel.

When prefixed with 'BB' or 'BBSL' this indicates the product is 'B' or 'BSL' style and cover is brass.

The number indicates the number of sockets included in the product.

The number '5' indicates that the product is a socket outlet.

This sequence indicates that the product is a twin socket outlet with a two piece base.

Colour reference of grid colours (e.g. BR is Brown).

BSL **1** **5** **V2A** **-BR**

Note: colour reference is separated by a dash from the catalogue number prefix.

Metal Plate

Custom Made Products



Custom Made Products

Metal Plate socket outlets can be ordered with additional features, including an extra switch mechanism, safety shutters, neons, 15A sockets, round Earth for lighting and more. Please refer to pages 66 to 67 under Switched Socket Outlets for more details.

There is also a range of custom made products and features that Clipsal can provide to meet your specific project requirements. Some of the options available are shown in the following section.

Oversized Plates

The 'BSL' range of products are available as standard in an oversized plate format (130mm x 85mm). Some of the remaining 'B' style plates (e.g. B15NA) are a standard measurement of 115mm x 70mm.

If uniformity is required across the project most 'B' style plates can be ordered in oversized (130mm x 85mm) format.

Oversized Plate Size



BSL25A-WE

Pictured: Stainless Steel

Standard Plate Size



B15NA-BK

Pictured: Stainless Steel

Metal Plate

Custom Made Products

Segregation Of Services

To comply with relevant wiring standards in some situations, it is important to ensure that power, light or data cables are segregated by an appropriate distance or approved barriers. In addition to standard segregated and fire rated wall boxes, Clipsal can custom design Metal Plate Wall Boxes with segregation barriers.



2157/2SB

Surface Mount

Surface mount multi-gang switch plates are ideal when walls are not deep enough to accept wall boxes; have services, such as gas/water located within the walls; or even to allow easier access when performing service work, maintenance or upgrades.

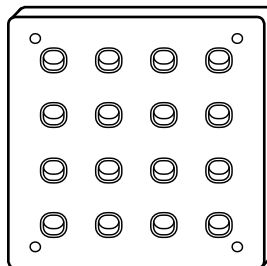

16/30/4

With surface mount box

Prestige

If larger mechanisms are required with a Metal Plate fascia, Clipsal can custom manufacture the Prestige (large switch) metal plate covers. These are ideal for aged care facilities or health care markets.

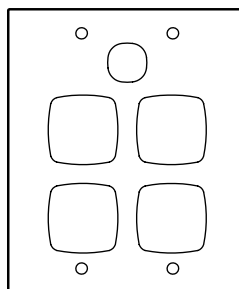

Pictured: four-gang metal plate cover to adapt to Prestige Mechanisms or socket outlets, and 30N neon

Lockable Doors

To prevent non-approved persons from accessing multi-gang switch panels, Clipsal provides lockable front doors (switch covers). The doors can be designed to be compatible with your facility's lock, or subject to availability, Clipsal can install a locking device to suit your project.



Pictured: multi-gang with lockable door.

Key Switches

Key switches provide increased security and control overloads compared to standard 30 Series Switch Mechanisms. Key switches are also available with barrels that accept 'common keys' to allow for alike keys across your project.



B31VK1
Metal Plate B Style, 1-Way,
locks in off position

Metal Plate

Custom Made Products

Fasteners (Screws)

In addition to providing additional fixing/mounting points, Clipsal offers fascia screws with options outside of standard slotted screw heads. This includes tamper-proof designs that make it impossible for persons to remove the front cover without the correct tool.

Clipsal can supply multi-gangs or other metal plate products with button head "pin-in-hex" socket security screws. They cannot be purchased as separate items. Available in lengths of 9.5mm or 19mm.

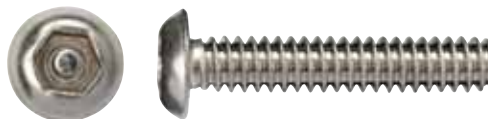

Pictured: "pin-in-hex" socket security screw

Additional Plate Fixings

To increase security on Metal Plate installations, Clipsal can provide additional fixing/mounting points on the front of the fascia cover plate. Mounting holes placed in the four corners of the metal plate will assist in preventing access to live electrics behind the plate. Refer to Metal Plate Security range on pages 80 - 85 for more information.



With standard fixing points

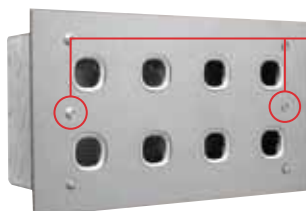

With additional fixing points

Optional Screw Lengths

If wall boxes are set back further than the standard wall depth or walls have tiles on them, the installer may require longer cover plate screws. Longer screws in 50mm or 75mm lengths are available for these installations. Additionally, 10mm shorter fascia screws are also available.



B31V-FS

10mm fascia screw, with BS M3.5 x 0.8 raised countersunk slotted head



B25-FS

50mm fascia screw with BS M3.5 x 0.8 raised countersunk slotted head (provided in packs of 10 and boxes of 100)



BSL25-FS

75mm Fascia Screw with BS M3.5 x 0.8 raised countersunk slotted head (provided in packs of 10 and boxes of 100)

Metal Plate

Product Details



Metal Plate Security Range

For many years Clipsal have provided custom-made metal plate products for environments that require additional security. They are ideal for gaols, detention centres, police stations, mental health, etc.

Clipsal's standard features for this range includes products with rounded corners, corner fixing points and additional grid mounting studs.

This Metal Plate Security range is now a standard offer for Clipsal. The range comprises:

- one to six gang switch plates
- single switched socket outlets with or without extra switches
- twin switched socket outlets with or without extra switches
- twin switched socket outlets with RCD protection
- blank flush plates
- blank flush plates with round holes.

All plates within the Metal Plate Security range are custom made to special order.

Installation Guidelines for Security Range Products

Unlike standard switches and sockets, the Metal Plate Security range are not mounted to wall surfaces at traditional 84mm mounting centres. There are no standard fixing screws supplied with each product. However, to assist with the mounting process there are 7mm diameter mounting holes placed in all four corners of each fascia plate. Holes are not countersunk and mounting screws will sit 'proud' of the cover plate.

Cavity Walls

There are no standard mounting brackets or clips available for the Metal Plate Security range, so it is recommended to use appropriate fasteners (e.g. toggle bolts). Alternatively, if other traditional fasteners are utilised, ensure wall studs or noggins are installed behind the four corner fixing points (see Figure 1). If wall boxes are used in cavity walls, they must be set back to clear grid plate assemblies (approximately 20mm) and wall boxes must be secured to appropriate wall structures.

Figure 1

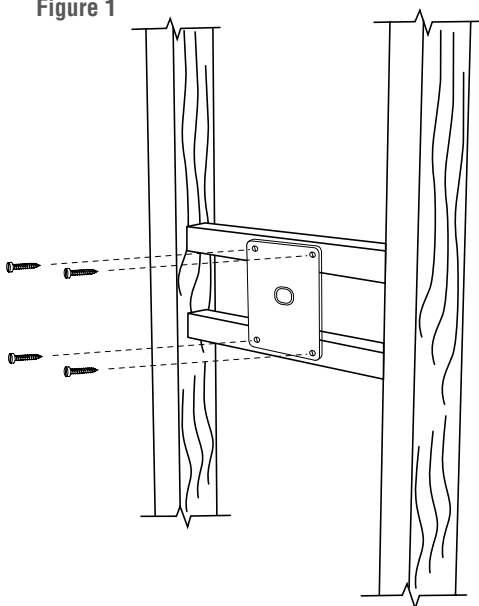

Masonry Walls

For masonry walls, it is recommended to use M5 Dynabolts with tamperproof screws or appropriate fasteners with wall plugs (see Figure 2).

If wall boxes are required for conduit termination, the 157 metal wall box is best suited, providing enough clearance for grid studs (see Figure 3).

Figure 2

Masonry wall installation

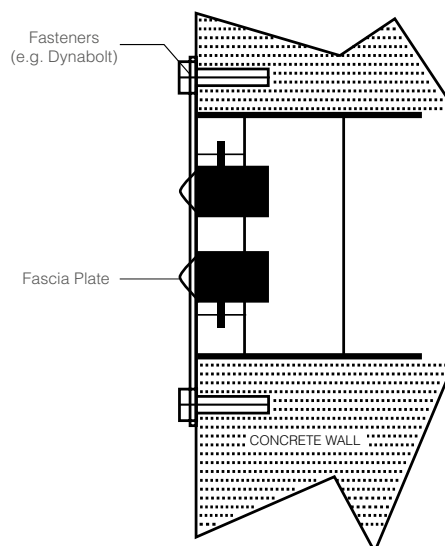

Figure 3

BSLS25A grid mounting stud positions and attached Earth strap



Metal Plate

Custom Made Security Products



Custom Made Metal Plate Security Range. Grid Plates with Fascias (Including Blank Plates)

Grid plates and fascias can be purchased together without the 30M Switch Mechanisms for convenience and greater choice. This option is particularly popular for projects that require specific mechanisms to be installed including: dimmers, fan controls, cooker mechanisms, data, telephone, television, neons, bell press, etc. They can be mounted either vertically or horizontally.

If no mechanisms are required at all, the BSLS31VX can be utilised. These are blank plates, which can be used for covering existing wall apertures or for mounting other control equipment (e.g. nurse call, emergency stop, key switches, etc).

To complement the Metal Plate Security Range of grid plates with fascias, a range of switched sockets is available in single or twin configuration, with or without extra switches, and with RCD options. They also have rounded corners and four corner fixing positions in 1.2mm flat stainless steel fascias.

Metal Plate Security Range - Stainless Steel Blank Plate -
Oversize for Security Applications

Catalogue No.	Length	Width	Depth	Mounting Centres	Corner Mounting Hole
All products	130mm	85mm	30mm	120 x 75mm	7mm ø

Description	
BSLS31VX	Blank Flush Grid Plate and 1.2mm flat stainless steel fascia. Has rounded corners and 4 corner fixing positions. Can be mounted vertically or horizontally.
BSLS31VXR1	As per BSLS31VX, with nominated single round aperture. Ideal for indicator lights, key switches, piezo switches, etc.
BSLS31VXR2	As per BSLS31VX, with two nominated round apertures. Ideal for indicator lights, key switches, piezo switches, etc.



BSLS31VX



BSLS31VXR1



BSLS31VXR2

All plates within the Metal Plate Security range are custom made to special order.

Metal Plate

Custom Made Security Products

Metal Plate Security Range - Grid Plates and Stainless Steel Fascias Blank Plate - Oversize

Catalogue No.	Length	Width	Depth	Mounting Centres	Corner Mounting Hole
All products	130mm	85mm	30mm	120 x 75mm	7mm ø

Description	
BSLS31VH	1-Gang Switch Plate with facility for 1 mechanism.
BSLS32VH	2-Gang Switch Plate with facility for 2 mechanism.
BSLS33VH	3-Gang Switch Plate with facility for 3 mechanism.
BSLS34VH	4-Gang Switch Plate with facility for 4 mechanism.
BSLS35VH	5-Gang Switch Plate with facility for 5 mechanism.
BSLS36VH	6-Gang Switch Plate with facility for 6 mechanism.

All plates within the Metal Plate Security range are custom made to special order.



BSLS31VH



BSLS32VH



BSLS33VH



BSLS34VH



BSLS35VH



BSLS36VH

Metal Plate Security Range - Stainless Steel Single Switched Socket Outlets - Oversize

Catalogue No.	Length	Width	Depth	Mounting Centres	Corner Mounting Hole
All products	130mm	85mm	35mm	120 x 75mm	7mm ø

Description	
BSLS15A	Single Switched Socket Outlet. 250V, 10A.
BSLS15XA	Single Switched Socket Outlet with removable extra switch. 250V, 10A.

All plates within the Metal Plate Security range are custom made to special order.



BSLS15A



BSLS15XA

Security Range - Stainless Steel Twin Switched Socket Outlets - Oversize for Security Applications

Catalogue No.	Length	Width	Depth	Mounting Centres	Corner Mounting Hole
All products	130mm	85mm	30mm	120 x 75mm	7mm ø

Description	
BSLS25A	Twin Switched Socket Outlet. 250V, 10A. Has rounded corners and 4 corner fixing positions in 1.2mm flat stainless steel fascia.
BSLS25XA	Twin Switched Socket Outlet with removable extra switch. Has rounded corners and 4 corner fixing positions in 1.2mm flat stainless steel fascia.
BSLS25RC	Twin Switched Socket Outlet with RCD. Has rounded corners and 4 corner fixing positions in 1.2mm flat stainless steel fascia.

All plates within the Metal Plate Security range are custom made to special order.

Note: twin switched sockets with extra switches or RCDs are available. However, consider mounting requirements, due to large grid on rear of plate.



BSLS25A



BSLS25XA



BSLS25RC

Metal Plate

Product Details



Flush Switches

These distinctive plates can accommodate up to four 30 Series Mechanisms in 'A' style format or six 30 Series Mechanisms in 'BSL' style format. All units are double insulated and suitable for vertical or horizontal mounting. The stainless steel switches look superb in today's kitchens, while the brass models beautifully complement more traditional decors.

Standard size flush switches are available in both 'A' and 'B' styles and oversized flush switches are available in 'BSL' series. All have 84mm mounting centres to suit all standard pattern mounting accessories. All switches supplied within the Metal Plate range are Clipsal's 30M Switch Mechanisms. All exposed mouldings are made of chemical resistant materials.

'A' Style Stainless Steel Switches - Standard Size

Catalogue No.	Length	Width	Depth	Mounting Centres
All products	115mm	70mm	30mm	84mm apart

Description	
A31VA	1-Gang Switch. 250V/10A, 1-way/2-way - standard size grid plate and 10mm deep curved stainless steel fascia, complete with one 30M switch in vertical format.
A32VA	2-Gang Switch. 250V/10A, 1-way/2-way - standard size grid plate and 10mm deep curved stainless steel fascia, complete with one 30M switch in vertical format.
A33VA	3-Gang Switch. 250V/10A, 1-way/2-way - standard size grid plate and 10mm deep curved stainless steel fascia, complete with one 30M switch in vertical format.
A34VA	4-Gang Switch. 250V/10A, 1-way/2-way - standard size grid plate and 10mm deep curved stainless steel fascia, complete with one 30M switch in vertical format.



A31VA



A32VA



A33VA



A34VA

'A' Style Polished Brass Switches - Standard Size

Catalogue No.	Length	Width	Depth	Mounting Centres
All products	115mm	70mm	30mm	84mm apart

Description	
BA31VA	1-Gang Switch. 250V/10A, 1-way/2-way - standard size gridplate and 10mm deep curved polished brass fascia, complete with two 30M switches in vertical format.
BA32VA	2-Gang Switch. 250V/10A, 1-way/2-way - standard size gridplate and 10mm deep curved polished brass fascia, complete with two 30M switches in vertical format.
BA33VA	3-Gang Switch. 250V/10A, 1-way/2-way - standard size gridplate and 10mm deep curved polished brass fascia, complete with two 30M switches in vertical format.
BA34VA	4-Gang Switch. 250V/10A, 1-way/2-way - standard size grid plate and 10mm deep curved polished brass fascia, complete with two 30M switches in vertical format.



BA31VA



BA32VA



BA33VA



BA34VA

Metal Plate

Product Details

'BSL' Style Stainless Steel Switches - Oversize

Catalogue No.	Length	Width	Depth	Mounting Centres
All products	130mm	85mm	30mm	84mm apart

Description	
BSL31VA	1-Gang Switch. 250V/10A, 1-way/2-way - oversize grid plate and 1.2mm flat stainless steel fascia, complete with one 30M switch in vertical format.
BSL32VA	2-Gang Switch. 250V/10A, 1-way/2-way - oversize grid plate and 1.2mm flat stainless steel fascia, complete with two 30M switch mechanisms in vertical format.
BSL33VA	3-Gang Switch. 250V/10A, 1-way/2-way - oversize grid plate and 1.2mm flat stainless steel fascia, complete with three 30M switch mechanisms in vertical format.
BSL34VA	4-Gang Switch. 250V/10A, 1-way/2-way - oversize grid plate and 1.2mm flat stainless steel fascia, complete with four 30M switch mechanisms in vertical format.
BSL35VA	5-Gang Switch. 250V/10A, 1-way/2-way - oversize grid plate and 1.2mm flat stainless steel fascia, complete with five 30M switch mechanisms in vertical format.
BSL36VA	6-Gang Switch. 250V/10A, 1-way/2-way - oversize grid plate and 1.2mm flat stainless steel fascia, complete with six 30M switch mechanisms in vertical format.

Cut outs: 73mm L x 50mm W.



BSL31VA



BSL32VA



BSL33VA

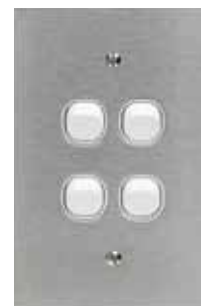

BSL34VA



BSL35VA

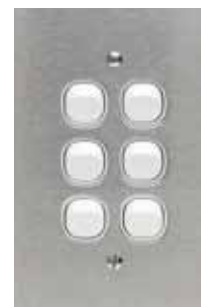

BSL36VA

“BBSL” Style Polished Brass Switches - Oversize

Catalogue No.	Length	Width	Depth	Mounting Centres
All products	130mm	85mm	30mm	84mm apart

Description	
BBSL31VA	1-Gang Switch. 250V/10A, 1-way/2-way - oversize grid plate and 1.2mm flat polished brass fascia, complete with one 30M switch in vertical format.
BBSL32VA	2-Gang Switch. 250V/10A, 1-way/2-way - oversize grid plate and 1.2mm flat polished brass fascia, complete with two 30M switch mechanisms in vertical format.
BBSL33VA	3-Gang Switch. 250V/10A, 1-way/2-way - oversize grid plate and 1.2mm flat polished brass fascia, complete with three 30M switch mechanisms in vertical format.
BBSL34VA	4-Gang Switch. 250V/10A, 1-way/2-way - oversize grid plate and 1.2mm flat polished brass fascia, complete with four 30M switch mechanisms in vertical format.
BBSL35VA	5-Gang Switch. 250V/10A, 1-way/2-way - oversize grid plate and 1.2mm flat polished brass fascia, complete with five 30M switch mechanisms in vertical format.
BBSL36VA	6-Gang Switch. 250V/10A, 1-way/2-way - oversize grid plate and 1.2mm flat polished brass fascia, complete with six 30M switch mechanisms in vertical format.

Cut outs: 73mm L x 50mm W.



BBSL31VA

BBSL32VA



BBSL33VA

BBSL34VA

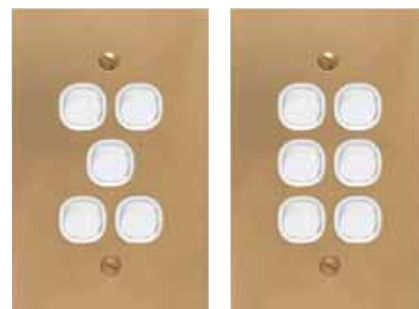

BBSL35VA

BBSL36VA

Metal Plate

Product Details

'BSL' Style Stainless Steel Medium Powered Universal Dimmer - Oversize

Catalogue No.	Length	Width	Depth	Mounting Centres
BSL31E4RUD	130mm	85mm	Front: 11mm Back: 45mm	84mm

Description	
BSL31E4RUD	Universal Dimmer. 2-way - oversize grid plate and 1.6mm flat stainless steel fascia. Integrally switched, rotary controlled (ISRC).

Parameter	Value
Rated voltage & frequency	220 - 240V ~ 50Hz
Rated power	10 - 800W
Load types	Incandescent, low voltage halogen/dichroic lights with iron-core transformers. Low voltage halogen/dichroic lights with electric transformers. Dimmable compact fluorescent lamps (400W max.). Dimmable LED lighting (400W max.). Smaller motor loads: exhaust fans (shaded pole induction motors). Ceiling fans (split-phase induction motors).
Operation temperature	0 - 45°C
Operating humidity range	10 - 90% R.H.
Safety compliance	AS/NZS3100, IEC60669-2-1
EMC Compliance	AS/NZS CISPR15, IEC61000-3-2 (except when used in conjunction with dimmable CFL loads).



BSL31E4RUD

Specifications typical at 240V, 25°C.

'BBSL' Style Polished Brass Medium Powered Universal Dimmer - Oversize

Catalogue No.	Length	Width	Depth	Mounting Centres
BBSL31E4RUD	130mm	85mm	Front: 11mm Back: 45mm	84mm

Description	
BBSL31E4RUD	Universal Dimmer. 2-way - oversize grid plate and 1.6mm flat polished brass fascia. Integrally switched, rotary controlled (ISRC).

Parameter	Value
Rated voltage & frequency	220 - 240V ~ 50Hz
Rated power	10 - 800W
Load types	Incandescent, low voltage halogen/dichroic lights with iron-core transformers. Low voltage halogen/dichroic lights with electric transformers. Dimmable compact fluorescent lamps (400W max.). Dimmable LED lighting (400W max.). Smaller motor loads: exhaust fans (shaded pole induction motors). Ceiling fans (split-phase induction motors).
Operation temperature	0 - 45°C
Operating humidity range	10 - 90% R.H.
Safety compliance	AS/NZS3100, IEC60669-2-1
EMC Compliance	AS/NZS CISPR15, IEC61000-3-2 (except when used in conjunction with dimmable CFL loads).



BBSL31E4RUD

Specifications typical at 240V, 25°C.

Metal Plate

Product Details



Architrave Flush Switches

Architrave flush switches are available in 'B' style only. An Earthing point is provided on all plates. These Metal Plate Architrave Switches are great for areas where there is limited access or wall space. Not only do they save space, they also blend in and are easy to locate.

Architrave Switch Plates - Mounting Templates

Mounting templates are provided below for all Clipsal Metal Plate Architrave Switch Plates. They can be used as a guide for drilling out of switch mechanism recesses, as well as mounting holes.

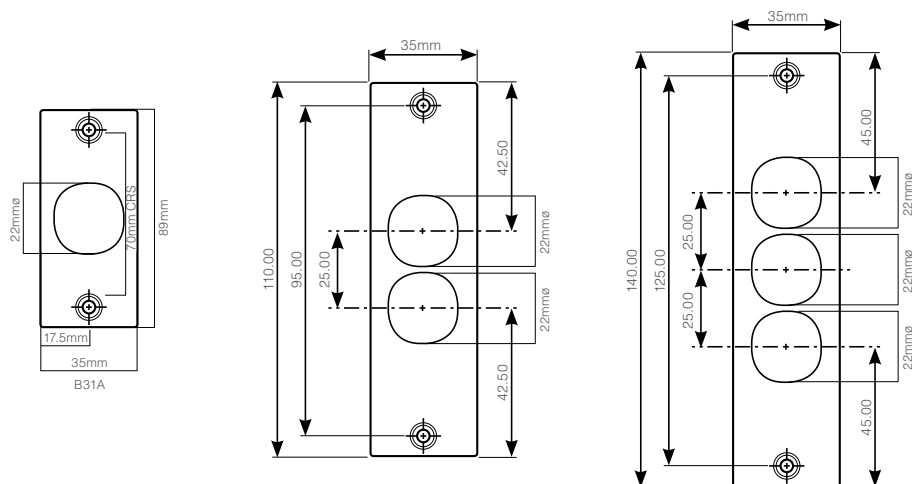

Note: images on this page are not drawn to scale.

'B' Style Stainless Steel and Polished Brass Switches - Architrave Size

Catalogue No.	Length	Width	Depth	Mounting Centres
B31A, BB31A	90mm	35mm	30mm	70mm
B32A, BB32A	110mm	35mm	30mm	95mm
B31A, BB31A	140mm	35mm	30mm	125mm

Description	
B31A	1-Gang Switch. 250V/10A, 1-way/2-way architrave grid plate and 1.6mm flat stainless steel fascia, complete with one 30M switch mechanism in vertical format.
BB31A	1-Gang Switch. 250V/10A, 1-way/2-way architrave grid plate and 1.6mm flat polished brass fascia, complete with one 30M switch mechanism in vertical format.
B32A	2-Gang Switch. 250V/10A, 1-way/2-way architrave grid plate and 1.6mm flat stainless steel fascia, complete with two 30M switch mechanisms in vertical format.
BB32A	2-Gang Switch. 250V/10A, 1-way/2-way architrave grid plate and 1.6mm flat polished brass fascia, complete with two 30M switch mechanisms in vertical format.
B33A	3-Gang Switch. 250V/10A, 1-way/2-way architrave grid plate and 1.6mm flat stainless steel fascia, complete with three 30M switch mechanisms in vertical format.
BB33A	3-Gang Switch. 250V/10A, 1-way/2-way architrave grid plate and 1.6mm flat polished brass fascia, complete with three 30M switch mechanisms in vertical format.



B31A



BB31A



B32A



BB32A



B33A



BB33A

Metal Plate

Product Details

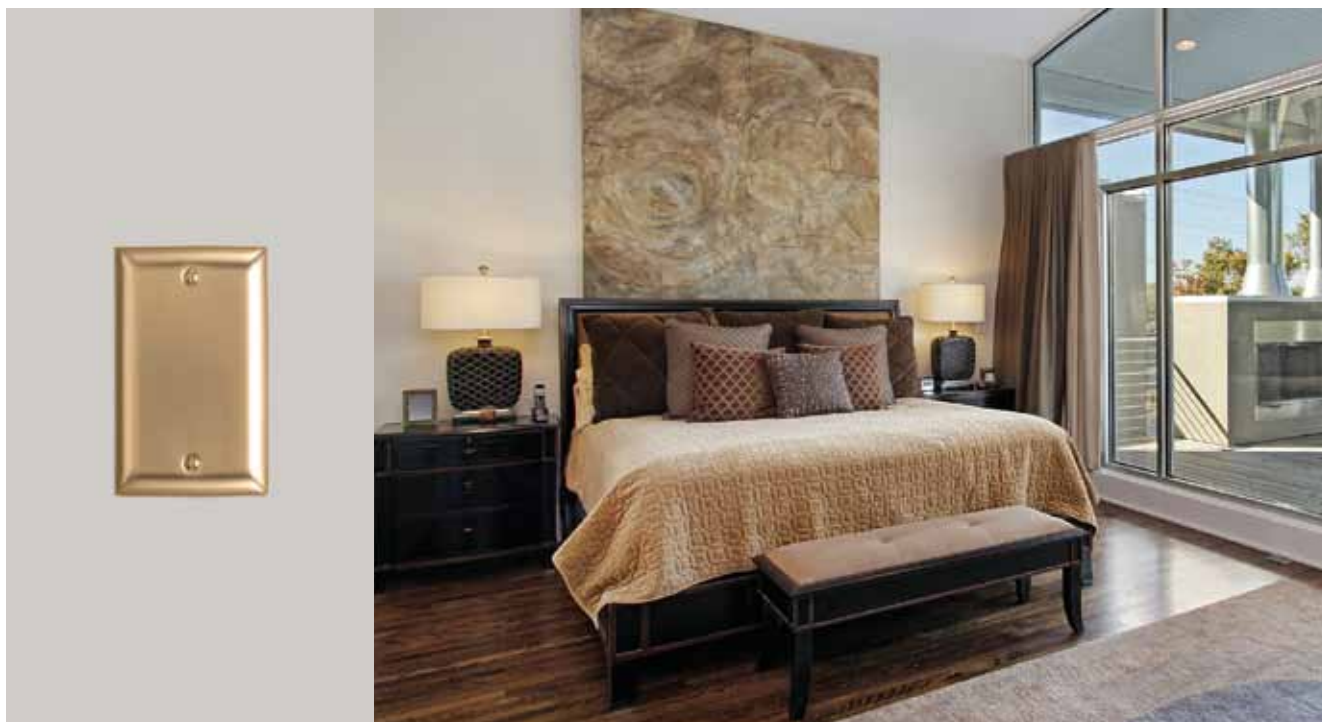

Grid Plates with Fascias (Including Blank Plates)

Grid plates and fascias can be purchased together without the 30M Switch Mechanisms for convenience and greater choice. This option is particularly popular for projects that require specific mechanisms to be installed including: dimmers, fan controls, cooker mechanisms, data, telephone, television, neons, bell press, etc. They can be mounted either vertically or horizontally.

If no mechanisms are required at all the A31VX or B31VX can be utilised. These are blank plates, which can be used for covering existing wall apertures or for mounting of other control equipment (e.g. nurse call, emergency stop, thermostats).

'A' Style Blank Plate Stainless Steel and Polished Brass - Standard Size

Catalogue No.	Length	Width	Depth	Mounting Centres
All products	115mm	70mm	10mm	84mm apart

Description	
A31VX	Blank Plate. Standard size, 10mm deep curved stainless steel fascia, suitable for mounting to any single-gang mounting accessory.
BA31VX	Blank Plate. Standard size, 10mm deep curved polished brass fascia, suitable for mounting to any single-gang mounting accessory.



A31VX



BA31VX

'B' Style Blank Plate Stainless Steel and Polished Brass - Standard Size

Catalogue No.	Length	Width	Depth	Mounting Centres
All products	115mm	70mm	1.6mm	84mm apart

Description	
B31VX	Blank Plate. Standard size, 1.6mm flat stainless steel fascia suitable for mounting to any single-gang mounting accessory. Oversized plates (B31VX-OS) measuring 130 x 85mm are available to special order.
BB31VX	Blank Plate. Standard size, 1.6mm flat polished brass fascia suitable for mounting to any single-gang mounting accessory. Oversized plates (BB31VX-OS) measuring 130 x 85mm are available to special order.



B31VX



BB31VX

Metal Plate

Product Details

'BSL' Style Grid Plates and Stainless Steel Fascias (Less Mechanisms) - Oversize

Catalogue No.	Length	Width	Depth	Mounting Centres
All products	130mm	85mm	8.7mm	84mm apart

Description	
BSL31VH	1-Gang Grid. Oversize, 1.2mm flat stainless steel fascia. Can be mounted vertically or horizontally.
BSL32VH	2-Gang Grid. Oversize 1.2mm flat stainless steel fascia. Can be mounted vertically or horizontally.
BSL33VH	3-Gang Grid. Oversize 1.2mm flat stainless steel fascia. Can be mounted vertically or horizontally.
BSL34VH	4-Gang Grid. Oversize 1.2mm flat stainless steel fascia. Can be mounted vertically or horizontally.
BSL35VH	5-Gang Grid. Oversize 1.2mm flat stainless steel fascia. Can be mounted vertically or horizontally.
BSL36VH	6-Gang Grid. Oversize 1.2mm flat stainless steel fascia. Can be mounted vertically or horizontally.

Cut outs: 73mm L x 50mm W

Note: if white switch mechanisms are to be inserted add:
 '-WE' after catalogue number for white, e.g. BSL31VH-WE
 '-BK' after catalogue number for black, e.g. BSL31VH-BK
 '-BR' after catalogue number for brown, e.g. BSL31VH-BR



BSL31VH



BSL32VH



BSL33VH



BSL34VH



BSL35VH



BSL36VH

'BBSL' Style Gridplates and Polished Brass Fascias (Less Mechanisms) - Oversize

Catalogue No.	Length	Width	Depth	Mounting Centres
All products	130mm	85mm	8.7mm	84mm apart

Description	
BBSL31VH	1-Gang Grid. Oversize 1.2mm flat polished brass fascia. Can be mounted vertically or horizontally.
BBSL32VH	2-Gang Grid. Oversize 1.2mm flat polished brass fascia. Can be mounted vertically or horizontally.
BBSL33VH	3-Gang Grid. Oversize 1.2mm flat polished brass fascia. Can be mounted vertically or horizontally.
BBSL34VH	4-Gang Grid. Oversize 1.2mm flat polished brass fascia. Can be mounted vertically or horizontally.
BBSL35VH	5-Gang Grid. Oversize 1.2mm flat polished brass fascia. Can be mounted vertically or horizontally.
BBSL36VH	6-Gang Grid. Oversize 1.2mm flat polished brass fascia. Can be mounted vertically or horizontally.

Cut outs: 73mm L x 50mm W

Note: if white switch mechanisms are to be inserted add:
 '-WE' after catalogue number for white, e.g. BBSL31VH-WE
 '-BK' after catalogue number for black, e.g. BBSL31VH-BK
 '-BR' after catalogue number for brown, e.g. BBSL31VH-BR

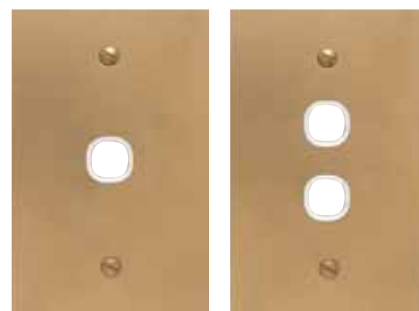

BBSL31VH

BBSL32VH

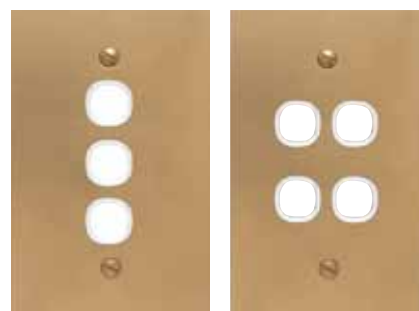

BBSL33VH

BBSL34VH

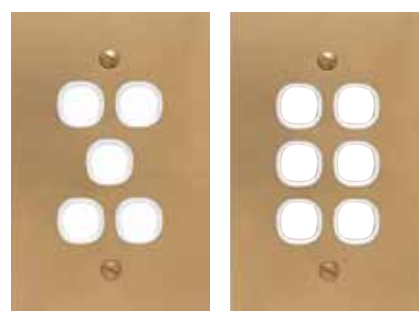

BBSL35VH

BBSL36VH

Metal Plate

Product Details



Multi-Gang Switch Assemblies

Clipsal 'B' Style multi-gang Switch Panels have been providing solutions to commercial environments for decades. Their flexibility in design allows them to accommodate up to 72 x 30 Series Mechanisms, dimmers, neons, key switches, data jacks, etc.

The low profile, versatility and premium aesthetics of the multi-gangs allow them to be installed in many areas, including modern restaurants, cafes, commercial offices, schools, hospitals, etc.

They can be provided in plain, or if required, with labels for ease of identification. All products listed are supplied as standard with Clipsal's quality wall boxes so that installation is a breeze.

Multi-Gang Switch Assemblies (Less Mechanisms) - Stainless Steel

Fascia

CatalogueNo.	Description	Length	Width
B4/30/2	4-Gang Switch Plate. 2 rows of 2. Stainless steel.	119mm	120mm
B6/30/3	6-Gang Switch Plate. 2 rows of 3. Stainless steel.	165mm	120mm
B8/30/4	8-Gang Switch Plate. 2 rows of 4. Stainless steel.	211mm	120mm
B10/30/5	10-Gang Switch Plate. 2 rows of 5. Stainless steel.	257mm	120mm
B12/30/6	12-Gang Switch Plate. 2 rows of 6. Stainless steel.	303mm	120mm
12/30/162/3	12-Gang Switch Plate. 4 rows of 3. Stainless steel.	165mm	215mm
14/30/7	14-Gang Switch Plate. 2 rows of 7. Stainless steel.	349mm	120mm
16/30/8	16-Gang Switch Plate. 2 rows of 8. Stainless steel.	395mm	120mm
16/30/162/4	16-Gang Switch Plate. 4 rows of 4. Stainless steel.	211mm	215mm
18/30/9	18-Gang Switch Plate. 2 rows of 9. Stainless steel.	441mm	120mm
20/30/10	20-Gang Switch Plate. 2 rows of 10. Stainless steel.	487mm	120mm

Wall Box

Catalogue No.	Width x Height x Depth
164/2	94 x 97 x 58mm
164/3	140 x 97 x 58mm
164/4	186 x 97 x 58mm
164/5	232 x 97 x 58mm
164/6	278 x 97 x 58mm
162/3	140 x 194 x 58mm
164/7	324 x 97 x 58mm
164/8	370 x 97 x 58mm
162/4	186 x 194 x 58mm
164/9	416 x 97 x 58mm
164/10	462 x 97 x 58mm



B4/30/2

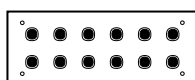

B12/30/6

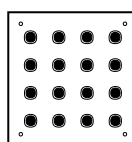

16/30/162/4

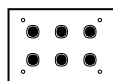

B6/30/3

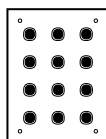

12/30/162/3

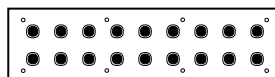

18/30/9

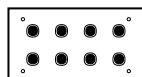

B8/30/4

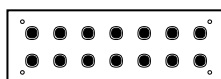

14/30/7

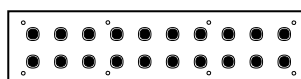

20/30/10

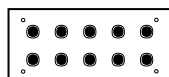

B10/30/5

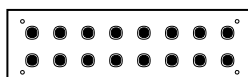

16/30/8

Includes stainless steel fascia with grid and wall box. Standard grid colours - White Electric (WE), Black (BK) and Brown (BR). Polished Brass fascias available to special order, price on application. All exposed moulded parts in the Metal Plate range are made from chemical resistant material.

Metal Plate

Product Details

Multi-Gang Switch Assemblies (Less Mechanisms) - Stainless Steel

Fascia

Catalogue No.	Description	Length	Width
20/30/162/5	20-Gang Switch Plate. 4 rows of 5. Stainless steel.	257mm	215mm
22/30/11	22-Gang Switch Plate. 2 rows of 11. Stainless steel.	533mm	120mm
24/30/12	24-Gang Switch Plate. 2 rows of 12. Stainless steel.	579mm	120mm
24/30/162/6	24-Gang Switch Plate. 4 rows of 6. Stainless steel.	303mm	215mm
24/30/163/4	24-Gang Switch Plate. 6 rows of 4. Stainless steel.	211mm	310mm
26/30/13	26-Gang Switch Plate. 2 rows of 13. Stainless steel.	625mm	120mm
28/30/14	28-Gang Switch Plate. 2 rows of 14. Stainless steel.	671mm	120mm
28/30/162/7	28-Gang Switch Plate. 4 rows of 7. Stainless steel.	349mm	215mm
30/30/15	30-Gang Switch Plate. 2 rows of 15. Stainless steel.	717mm	120mm
30/30/163/5	30-Gang Switch Plate. 6 rows of 5. Stainless steel.	257mm	310mm
32/30/162/8	32-Gang Switch Plate. 4 rows of 8. Stainless steel.	395mm	215mm

Wall Box

Catalogue No.	Width x Height x Depth
162/5	232 x 194 x 58mm
164/11	508 x 97 x 58mm
164/12	554 x 97 x 58mm
162/6	278 x 194 x 58mm
163/4	186 x 290 x 58mm
164/13	600 x 97 x 58mm
164/14	646 x 97 x 58mm
162/7	324 x 194 x 58mm
164/15	692 x 97 x 58mm
163/5	232 x 290 x 58mm
162/8	370 x 194 x 58mm

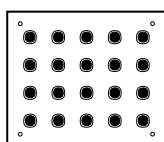
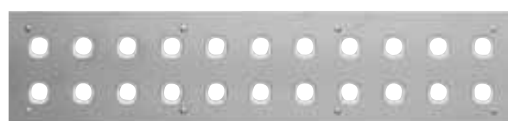
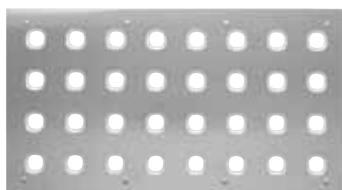

20/30/162/5

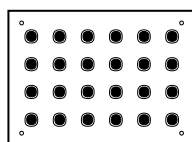

24/30/163/4

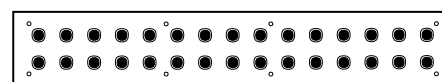

30/30/15

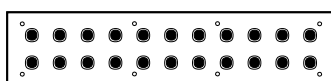

22/30/11

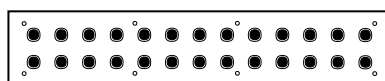

26/30/13

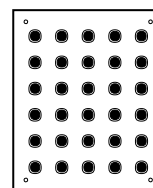

24/30/162/6

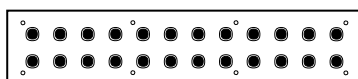

24/30/12

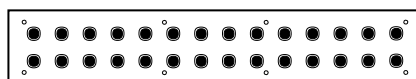

28/30/14

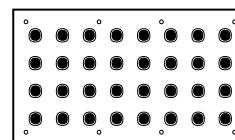

32/30/162/8

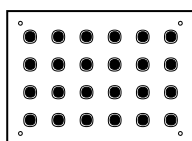

24/30/162/6

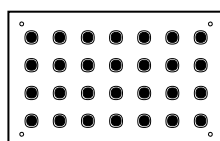

28/30/162/7

Includes stainless steel fascia with grid and wall box. Standard grid colours - White Electric (WE), Black (BK) and Brown (BR). Polished Brass fascias available to special order, price on application. All exposed moulded parts in the Metal Plate range are made from chemical resistant material.

Multi-Gang Switch Assemblies (Less Mechanisms) - Stainless Steel

Fascia

Catalogue No.	Description	Length	Width	Catalogue No.	Width x Height x Depth
36/30/162/9	36-Gang Switch Plate. 4 rows of 9. Stainless steel.	441mm	215mm	162/9	416 x 194 x 58mm
36/30/163/6	36-Gang Switch Plate. 6 rows of 6. Stainless steel.	303mm	310mm	163/6	278 x 290 x 58mm
40/30/162/10	40-Gang Switch Plate. 4 rows of 10. Stainless steel.	487mm	215mm	162/10	462 x 194 x 58mm
42/30/163/7	42-Gang Switch Plate. 6 rows of 7. Stainless steel.	349mm	310mm	163/7	324 x 290 x 58mm
44/30/162/11	44-Gang Switch Plate. 4 rows of 11. Stainless steel.	533mm	215mm	162/11	508 x 194 x 58mm
48/30/162/12	48-Gang Switch Plate. 4 rows of 12. Stainless steel.	579mm	215mm	162/12	554 x 194 x 58mm
48/30/163/8	48-Gang Switch Plate. 6 rows of 8. Stainless steel.	395mm	310mm	163/8	370 x 290 x 58mm
54/30/163/9	54-Gang Switch Plate. 6 rows of 9. Stainless steel.	441mm	310mm	163/9	416 x 290 x 58mm
60/30/163/10	60-Gang Switch Plate. 6 rows of 10. Stainless steel.	487mm	310mm	163/10	462 x 290 x 58mm
66/30/163/11	66-Gang Switch Plate. 6 rows of 11. Stainless steel.	533mm	310mm	163/11	508 x 290 x 58mm
72/30/163/12	72-Gang Switch Plate. 6 rows of 12. Stainless steel.	579mm	310mm	163/12	554 x 290 x 58mm

Wall Box

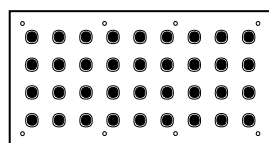

36/30/162/9

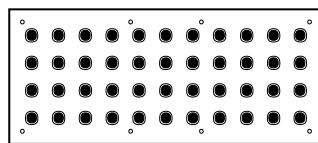

44/30/162/11

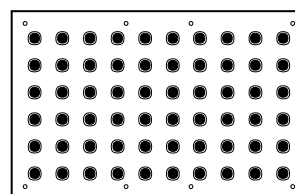

60/30/163/10

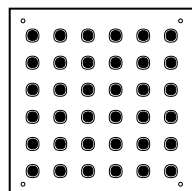

36/30/163/6

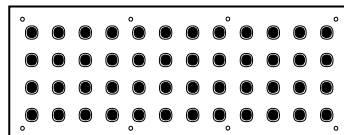

48/30/162/12

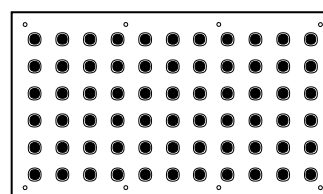

66/30/163/11

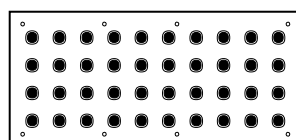

40/30/162/10

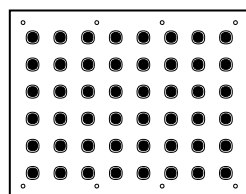

48/30/163/8

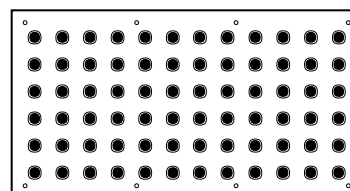

72/30/163/12

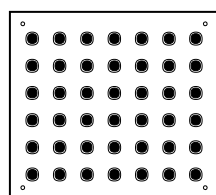

42/30/163/7

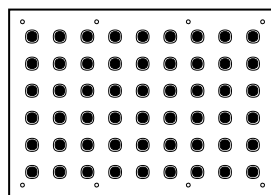

54/30/163/9

Includes stainless steel fascia with grid and wall box. Standard grid colours - White Electric (WE), Black (BK) and Brown (BR). Polished Brass fascias available to special order, price on application. All exposed moulded parts in the Metal Plate range are made from chemical resistant material.

Metal Plate

Product Details

Multi-Gang Switch Assemblies - Labelling Options

All Clipsal multi-gang products can be labelled using three alternative labelling options as follows:

Option 1: labelled multi-gangs

Option 2: direct engraving of plates

Option 3: messages directly to switch dollies.

Labelled Multi-Gangs

Labelled multi-gang products are provided with plastic strips that can be engraved and are coated with a removable transparent protective film. The strips are a two-ply design (white on black) that are screw fixed across the full length of the multi-gangs grid assembly. For each row of the labelled multi-gang, there is a full plastic strip provided.

If required, engraving on the plastic strips can be provided in 3mm Arial font. The front metal fascia of the labelled Multi-Gang has individual window apertures measuring 31mm wide x 6mm high.

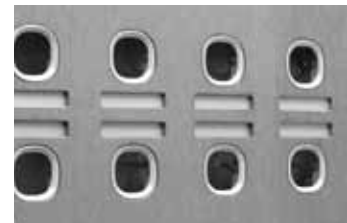

Engraved Multi-Gangs

Plate engraving - alternatively if labelled multi-gangs are not suitable, direct engraving on the front metal fascia is available. Standard black font for this option is 4mm, other colours and font sizes are available upon special request.



Message Mechanisms

In addition to labelling or plate engraving, one of the more popular forms of labelling is to 'laser etch' or 'hot stamp' the face of the 30 series dollies with your preferred message. There are a number of standard messages available that are shown on pages 58 to 59.



Multi-Gang Switch Assemblies - Labelled Versions (Less Mechanisms) - Stainless Steel

Fascia

Catalogue No.	Description	Length	Width
B4/30L2	4-Gang Labelled Switch Plate. 2 rows of 2. Stainless steel.	119mm	120mm
B6/30L3	6-Gang Labelled Switch Plate. 2 rows of 3. Stainless steel.	165mm	120mm
B8/30L4	8-Gang Labelled Switch Plate. 2 rows of 4. Stainless steel.	211mm	120mm
B10/30L5	10-Gang Labelled Switch Plate. 2 rows of 5. Stainless steel.	257mm	120mm
B12/30L6	12-Gang Labelled Switch Plate. 2 rows of 6. Stainless steel.	303mm	120mm
12/30L162/3	12-Gang Labelled Switch Plate. 4 rows of 3. Stainless steel.	165mm	215mm
14/30L7	14-Gang Labelled Switch Plate. 2 rows of 7. Stainless steel.	349mm	120mm
16/30L8	16-Gang Labelled Switch Plate. 2 rows of 8. Stainless steel.	395mm	120mm
16/30L162/4	16-Gang Labelled Switch Plate. 4 rows of 4. Stainless steel.	211mm	215mm
18/30L9	18-Gang Labelled Switch Plate. 2 rows of 9. Stainless steel.	441mm	120mm
20/30L10	20-Gang Labelled Switch Plate. 2 rows of 10. Stainless steel.	487mm	120mm

Wall Box

Catalogue No.	Width x Height x Depth
164/2	94 x 97 x 58mm
164/3	140 x 97 x 58mm
164/4	186 x 97 x 58mm
164/5	232 x 97 x 58mm
164/6	278 x 97 x 58mm
162/3	140 x 194 x 58mm
164/7	324 x 97 x 58mm
164/8	370 x 97 x 58mm
162/4	186 x 194 x 58mm
164/9	416 x 97 x 58mm
164/10	462 x 97 x 58mm

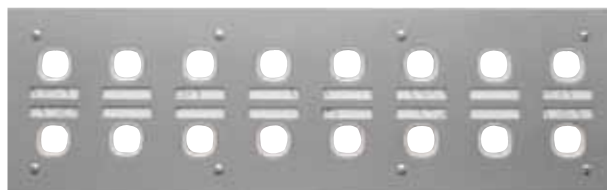
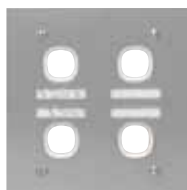

B4/30L2

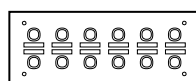

B12/30L6

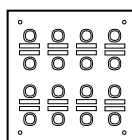

16/30L162/4

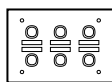

B6/30L3

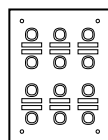

12/30L162/3

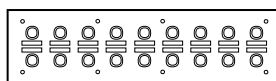

18/30L9

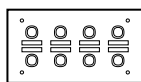

B8/30L4

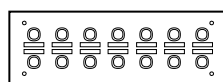

14/30L7

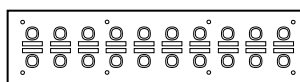

20/30L10

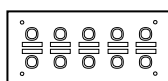

B10/30L5

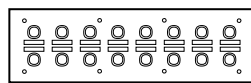

16/30L8

Includes stainless steel fascia with grid and wall box. Standard grid colours - White Electric (WE), Black (BK) and Brown (BR). Polished Brass fascias available to special order, price on application. All exposed moulded parts in the Metal Plate range are made from chemical resistant material.

Metal Plate

Product Details

Multi-Gang Switch Assemblies - Labelled Versions (Less Mechanisms) - Stainless Steel

Fascia

Catalogue No.	Description	Length	Width
20/30L162/5	20-Gang Labelled Switch Plate. 4 rows of 5. Stainless steel.	257mm	215mm
22/30L11	22-Gang Labelled Switch Plate. 2 rows of 11. Stainless steel.	533mm	120mm
24/30L162/6	24-Gang Labelled Switch Plate. 4 rows of 6. Stainless steel.	303mm	215mm
24/30L163/4	24-Gang Labelled Switch Plate. 6 rows of 4. Stainless steel.	211mm	310mm
28/30L162/7	28-Gang Labelled Switch Plate. 4 rows of 7. Stainless steel.	349mm	215mm
30/30L163/5	30-Gang Labelled Switch Plate. 6 rows of 5. Stainless steel.	257mm	310mm
32/30L162/8	32-Gang Labelled Switch Plate. 4 rows of 8. Stainless steel.	395mm	215mm
36/30L163/6	36-Gang Labelled Switch Plate. 6 rows of 6. Stainless steel.	303mm	310mm
40/30L162/10	40-Gang Labelled Switch Plate. 4 rows of 10. Stainless steel.	487mm	215mm
42/30L163/7	42-Gang Labelled Switch Plate. 6 rows of 7. Stainless steel.	487mm	310mm
44/30L162/11	44-Gang Labelled Switch Plate. 4 rows of 11. Stainless steel.	533mm	215mm

Wall Box

Catalogue No.	Width x Height x Depth
162/5	232 x 194 x 58mm
164/11	508 x 97 x 58mm
162/6	278 x 194 x 58mm
163/4	186 x 290 x 58mm
162/7	324 x 194 x 58mm
163/5	232 x 290 x 58mm
162/8	370 x 194 x 58mm
163/6	278 x 290 x 58mm
162/10	462 x 194 x 58mm
163/7	324 x 290 x 58mm
162/11	508 x 194 x 58mm

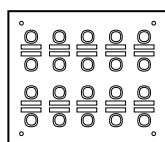
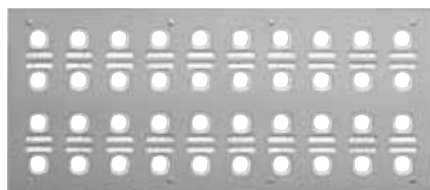
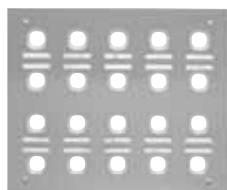

20/30L162/5

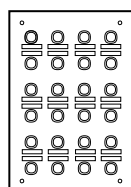

24/30L163/4

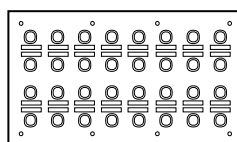

32/30L162/8

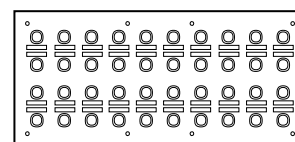

40/30L162/10

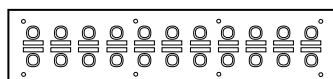

22/30L11

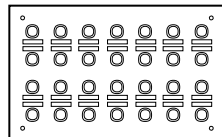

28/30L162/7

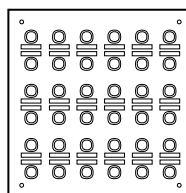

36/30L163/6

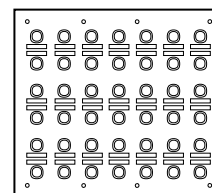

42/30L163/7

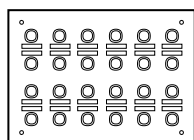

24/30L162/6

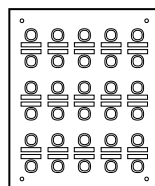

30/30L163/5

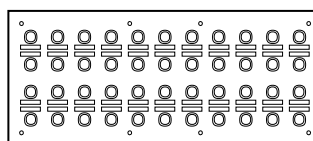

44/30L162/11

Includes stainless steel fascia with grid and wall box. Standard grid colours - White Electric (WE), Black (BK) and Brown (BR). Polished brass fascias available to special order, price on application. All exposed moulded parts in the Metal plate range are made from chemical resistant material.

Multi-Gang Switch Assemblies - Labelled Versions (Less Mechanisms) - Stainless Steel

Fascia

Catalogue No.	Description	Length	Width
48/30L163/8	48-Gang Labelled Switch Plate. 6 rows of 8. Stainless steel.	395mm	310mm
52/30L162/13	52-Gang Labelled Switch Plate. 4 rows of 13. Stainless steel.	625mm	215mm
54/30L163/9	54-Gang Labelled Switch Plate. 6 rows of 9. Stainless steel.	441mm	310mm
56/30L162/14	56-Gang Labelled Switch Plate. 4 rows of 14. Stainless steel.	487mm	310mm
60/30L162/15	60-Gang Labelled Switch Plate. 4 rows of 15. Stainless steel.	717mm	215mm
60/30L163/10	60-Gang Labelled Switch Plate. 6 rows of 10. Stainless steel.	395mm	310mm

Wall Box

Catalogue No.	Width x Height x Depth
163/8	370 x 290 x 58mm
162/13	600 x 194 x 58mm
163/9	416 x 290 x 58mm
162/14	646 x 194 x 58mm
162/15	692 x 194 x 58mm
163/10	462 x 290 x 58mm

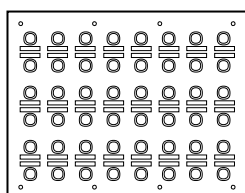
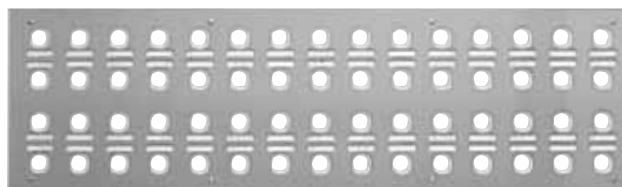
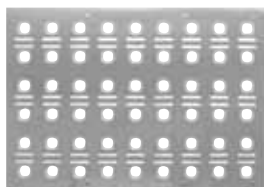

48/30L163/8

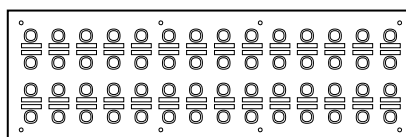

56/30L162/14

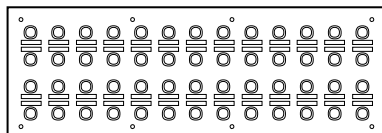

52/30L162/13

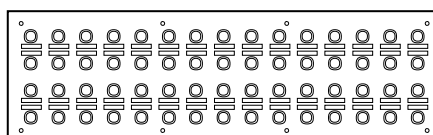

60/30L162/15

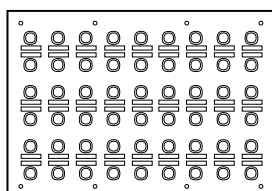

54/30L163/9

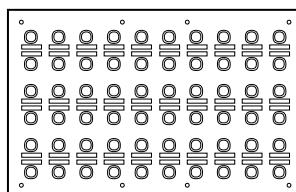

60/30L163/10

Includes stainless steel fascia with grid and wall box. Standard grid colours - White Electric (WE), Black (BK) and Brown (BR). Polished brass fascias available to special order, price on application. All exposed moulded parts in the Metal plate range are made from chemical resistant material.

Metal Plate

Product Details

Labelled Mechanisms

In addition to labelling or plate engraving, one of the more popular forms of labelling is to 'laser etch' or 'hot stamp' the 30 Series Mechanisms with your preferred message. There are a number of standard messages available that are shown below.

Clipsal can provide one, two or three rows of text. Font sizes are typically 1.9mm high and font style is 'Helvetica Narrow'.

Message Mechanisms

Catalogue No.	Labelled	Catalogue No.	Labelled
30ACM	AIR CON	30PM	DISPOSAL
30AM	ALARM	30DM	DINE
30BM	BATH	30EM	EXHAUST
30BDM	BED	30FAM	FAMILY
30BD1M	BED 1	30FM	FAN
30BD2M	BED 2	30MFD	FRIDGE
30BD3M	BED 3	30HM	HEAT
30BD4M	BED 4	30HLM	HI / LO
30COM	COOL	30KM	KITCHEN
30DNM	DAY / NIGHT	30LM	LIGHT

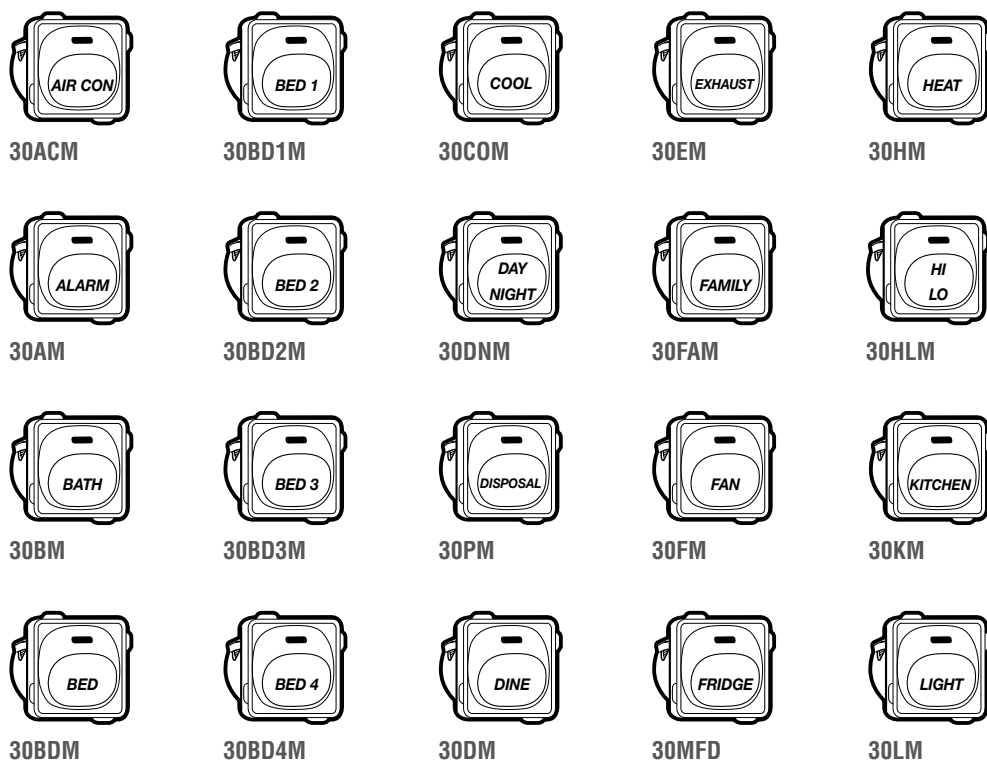

Message Mechanisms

Catalogue No.	Labelled	Catalogue No.	Labelled
30LOM	LOUNGE	30YM	WASH
30MAM	MAN - AUTO	30XM	WASTE
30MMW	MICROWAVE	30MZ1	ZONE 1
30M-MIRROR	MIRROR	30MZ2	ZONE 2
30FNM	OFF/ON	30MZ3	ZONE 3
30MOS	OUTSIDE	30MZ4	ZONE 4
30PUM	PUMP	39M	HI/OFF/LO
30RUM	RUMPUS	39MSON	SENSOR/OFF/ON
30MSEN	SENSOR	39MUOD	UP/OFF/DOWN
30STM	STUDY	39MAOM	AUTO/OFF/MAN
30TM	TV		

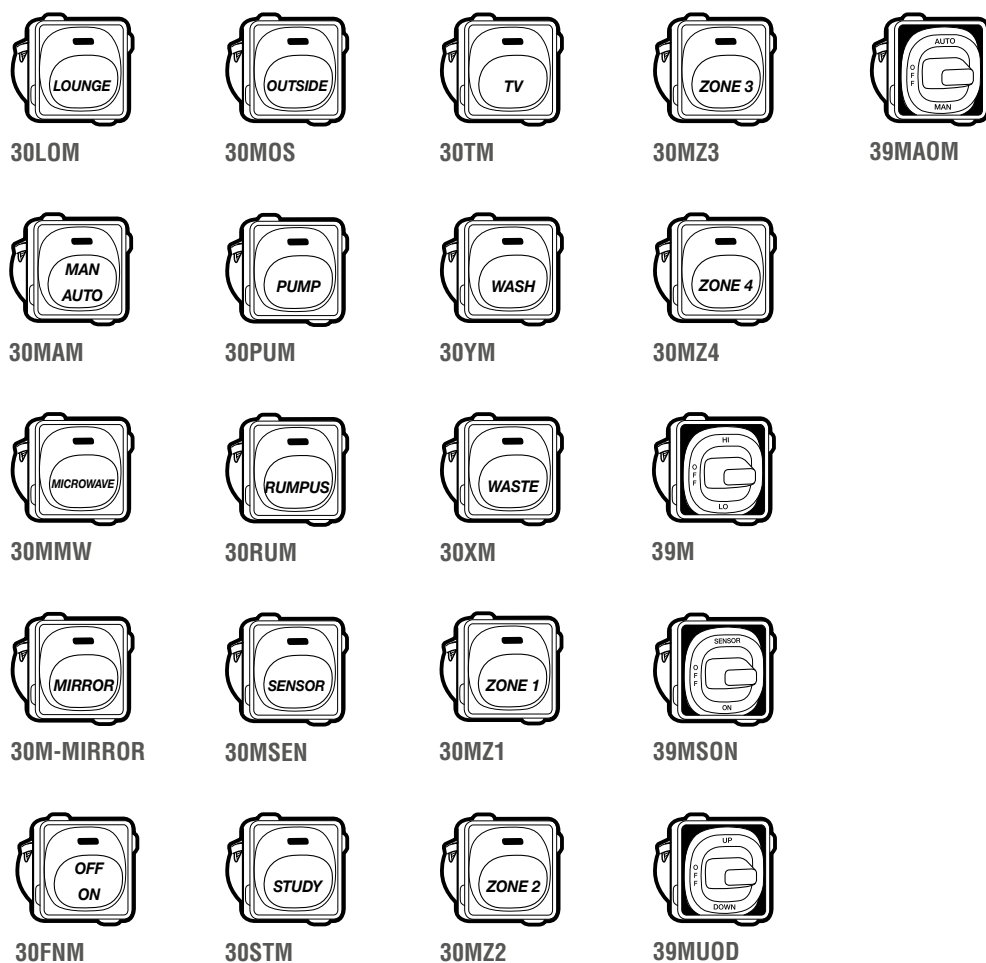

Metal Plate

Product Details

Multi-Gang Wall Boxes

All Clipsal Metal Plate Wall Boxes are manufactured from 0.9mm steel and are bright electro-galvanised. They are solidly spot-welded together and ample knock-outs are provided with cable entry from all directions. They are drilled and tapped to mount standard pattern mounting accessories with 84mm x 46mm increment centres.

The corresponding Clipsal metal wall boxes designed for use with multi-gang switch panels are shown in the accompanying multi-gang switch panel tables. More information on these wall boxes is shown on the following pages, as well as on the mounting accessories cross-reference chart shown at the back of this book.

It is important to note that when used with multi-gang switch panels or specific oversized 'B' style metal plates, wall boxes must be set a minimum of 16mm below the finished wall surface. This provides enough clearance for grid plate assemblies and also for adjustment on uneven walls.

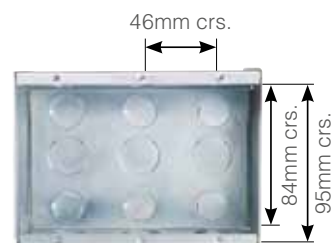

164/3

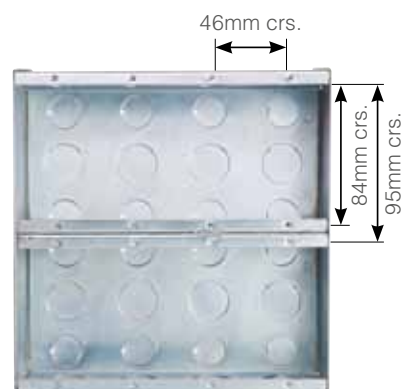

162/4



163/4

Step-By-Step Installation of a Multi-Gang Switch Panel



Step 1.
Mark out location of multi-gang wall box (use outside of wall box as a guide).



Step 2.
Cut-out wall box position.



Step 3.
Knock out appropriate cable entry points (ensure sharp edges are removed). Insert wall box.



Step 4.
Ensuring wall box is a minimum of 16mm below finished wall surface, screw-fix to wall studs.



Step 5.
Insert switch mechanisms (supplied separately) into grid plate.



Step 6.
Connect cables to switch mechanisms. Back off adjustment screws 'Y' in grid plate.



Step 7.
Insert fixing screws 'Z' through grid plate and engage into wall box mounting holes. Place a straight edge on finished wall face across switch assemblies.



Step 8.
Adjust screws 'Y' & 'Z' in and out until all shoulders on moulded mechanism clips align with finished wall face.



Step 9.
Place metal fascia (cover plate) over mechanisms and secure with screws 'X' to grid plate.



Step 10.
Finished installation.

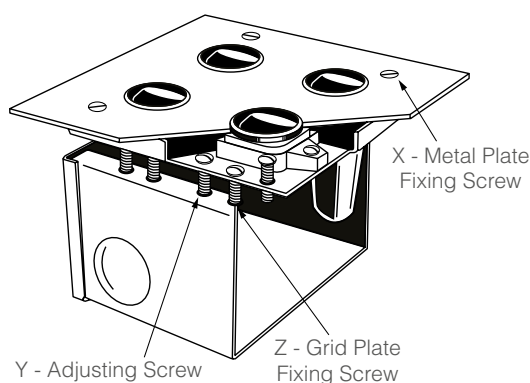

Metal Plate

Product Details

Metal Wall Boxes - 164 Series (Single Height Versions)

Catalogue No.	Description	Length	Width	Depth	Mounting Centres
	Metal Wall Box supplied with fixed nuts, precision stamped from 0.9mm strip bright electro-galvanised, for poured concrete (suits universal wall construction).				
164/2	2-Gang Metal Wall Box, single height.	96mm	97mm	58mm	84mm x 46mm
164/3	3-Gang Metal Wall Box, single height.	142mm	97mm	58mm	84mm x 46mm
164/4	4-Gang Metal Wall Box, single height.	188mm	97mm	58mm	84mm x 46mm
164/5	5-Gang Metal Wall Box, single height.	234mm	97mm	58mm	84mm x 46mm
164/6	6-Gang Metal Wall Box, single height.	280mm	97mm	58mm	84mm x 46mm
164/7	7-Gang Metal Wall Box, single height.	326mm	97mm	58mm	84mm x 46mm
162/8	8-Gang Metal Wall Box, single height.	372mm	97mm	58mm	84mm x 46mm

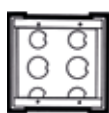

164/2

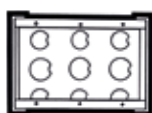

164/3

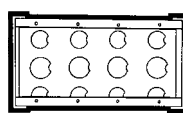

164/4

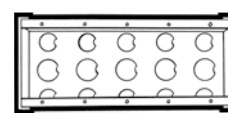

164/5

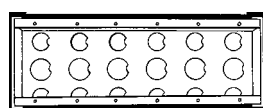

164/6

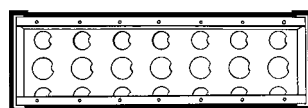

164/7

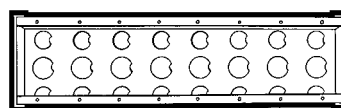

164/8

Metal Wall Boxes - 164 Series (Single Height Versions)

Catalogue No.	Description	Length	Width	Depth	Mounting Centres
	Metal wall box supplied with fixed nuts, precision stamped from 0.9mm strip bright electro-galvanised, for poured concrete (suits universal wall construction).				
164/9	9-Gang Metal Wall Box, single height.	418mm	97mm	58mm	84mm x 46mm
164/10	10-Gang Metal Wall Box, single height.	464mm	97mm	58mm	84mm x 46mm
164/11	11-Gang Metal Wall Box, single height.	510mm	97mm	58mm	84mm x 46mm
164/12	12-Gang Metal Wall Box, single height.	556mm	97mm	58mm	84mm x 46mm
162/13	13-Gang Metal Wall Box, single height.	600mm	97mm	58mm	84mm x 46mm

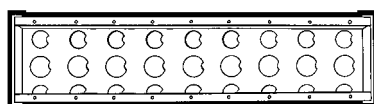

164/9

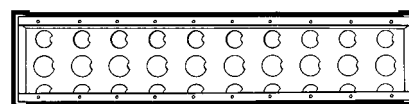

164/10

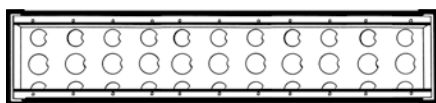

164/11

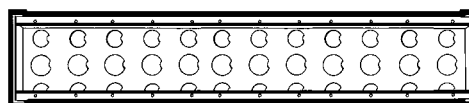

164/12

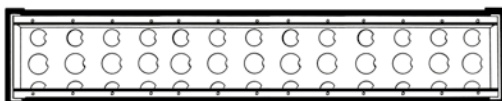

164/13

Metal Wall Boxes - 162 Series (Double Height Versions)

Catalogue No.	Description	Length	Width	Depth	Mounting Centres
	Metal wall box supplied with fixed nuts, precision stamped from 0.9mm strip bright electro-galvanised, for poured concrete (suits universal wall construction).				
162/3	3-Gang Metal Wall Box, double height.	140mm	194mm	58mm	84mm x 46mm
162/4	4-Gang Metal Wall Box, double height.	186mm	194mm	58mm	84mm x 46mm
162/5	5-Gang Metal Wall Box, double height.	232mm	194mm	58mm	84mm x 46mm
162/6	6-Gang Metal Wall Box, double height.	278mm	194mm	58mm	84mm x 46mm
162/7	7-Gang Metal Wall Box, double height.	324mm	194mm	58mm	84mm x 46mm

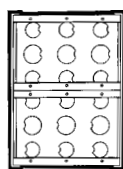

162/3

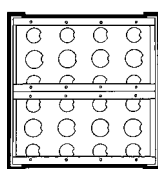

162/4

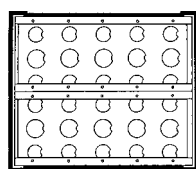

162/5

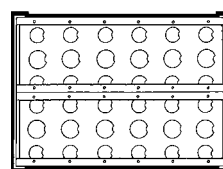

162/6

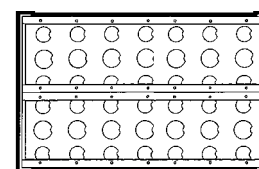

162/7

Metal Wall Boxes - 162 Series (Double Height Versions)

Catalogue No.	Description	Length	Width	Depth	Mounting Centres
	Metal wall box supplied with fixed nuts, precision stamped from 0.9mm strip bright electro-galvanised, for poured concrete (suits universal wall construction).				
162/8	8-Gang Metal Wall Box, double height.	370mm	194mm	58mm	84mm x 46mm
162/9	9-Gang Metal Wall Box, double height.	416mm	194mm	58mm	84mm x 46mm
162/10	10-Gang Metal Wall Box, double height.	462mm	194mm	58mm	84mm x 46mm
162/12	12-Gang Metal Wall Box, double height.	554mm	194mm	58mm	84mm x 46mm
162/14	14-Gang Metal Wall Box, double height.	646mm	194mm	58mm	84mm x 46mm

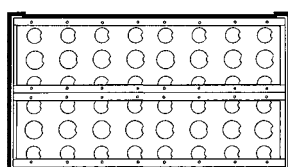

162/8

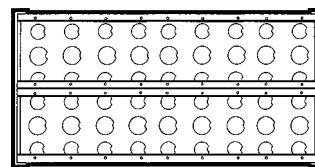

162/9

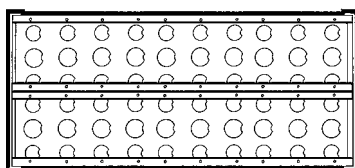

162/10

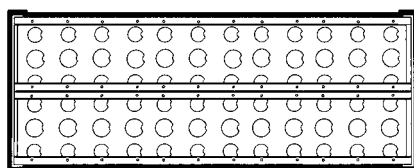

162/12

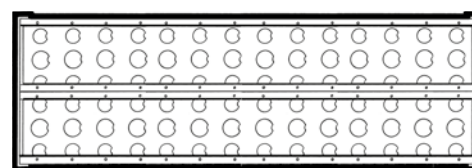

162/14

Metal Plate

Product Details

Metal Wall Boxes - 163 Series (Triple Height Versions)

Catalogue No.	Description	Length	Width	Depth	Mounting Centres
	Metal Wall Box supplied with fixed nuts, precision stamped from 0.9mm strip bright electro-galvanised, for poured concrete (suits universal wall construction).				
163/4	4-Gang Metal Wall Box, triple height.	189mm	289mm	58mm	84mm x 46mm
163/5	5-Gang Metal Wall Box, triple height.	235mm	289mm	58mm	84mm x 46mm
163/6	6-Gang Metal Wall Box, triple height.	278mm	289mm	58mm	84mm x 46mm
163/7	7 Gang Metal Wall Box, triple height.	324mm	289mm	58mm	84mm x 46mm

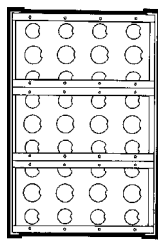

163/4

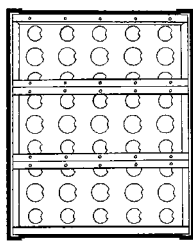

163/5

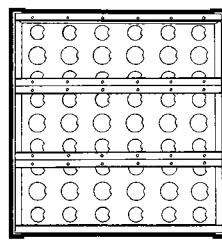

163/6

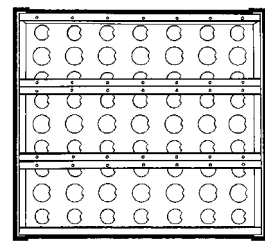

163/7

Metal Wall Boxes - 163 Series (Triple Height Versions)

Catalogue No.	Description	Length	Width	Depth	Mounting Centres
	Metal wall box supplied with fixed nuts, precision stamped from 0.9mm strip bright electro-galvanised steel, for poured concrete (suits universal wall construction).				
163/8	8-Gang Metal Wall Box, triple height.	370mm	289mm	58mm	84mm x 46mm
163/9	9-Gang Metal Wall Box, triple height.	416mm	289mm	58mm	84mm x 46mm
163/10	10-Gang Metal Wall Box, triple height.	462mm	289mm	58mm	84mm x 46mm

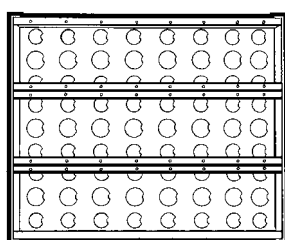

163/8

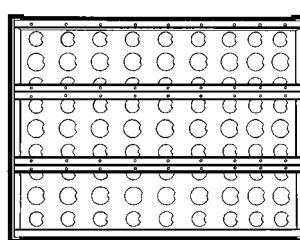

163/9

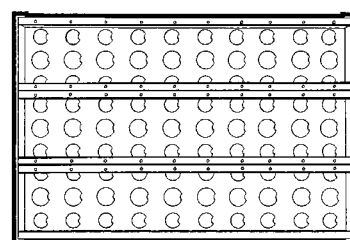

163/10

Metal Plate

Product Details



Switched Socket Outlets

Clipsal offer a complete range of Switched Socket Outlets to match the Metal Plate Flush Switches. 'A', 'B' and 'BSL' style plates are available in both stainless steel and brass finishes.

They are perfect for use in commercial areas where chemical resistance is required (the moulded area of the socket outlet and switches is chemical resistant), but are also great for use in hotels, foyers, hospitals, security areas, government buildings, up-market homes, kitchen splashbacks and schools. All models are double insulated.

The prestigious look of the Metal Plate Switched Socket Outlets make them a fantastic feature in commercial environments and also stainless steel kitchens (anywhere where a prestigious look is desired).

It is worth noting that the BSL25A Twin Switched Socket is designed so it can be fitted to most standard wall clips, brackets and boxes, without the need for any special mounting requirements or changes to installation methods.

'A' Style Stainless Steel Single Switched Socket Outlets - Horizontal Mounting

Catalogue No.	Length	Width	Depth	Mounting Centres
A15A, A15LA, A15NA, A15SA, A15/15A, A15/15NA	115mm	70mm	30mm	84mm apart
A15M, A15/15M	105mm	55mm	28mm (rear projection)	84mm apart



A15A

Description	
A15A	Single Switched Socket Outlet, 250V, 10A, deep curved - stainless steel.
A15LA	Single Switched Socket Outlet, 250V, 10A, deep curved, with round Earth pin - stainless steel.
A15NA	Single Switched Socket Outlet, 250V, 10A, deep curved, with shutter and neon - stainless steel.
A15SA	Single Switched Socket Outlet, 250V, 10A, deep curved, with safety shutter - stainless steel.
A15/15A	Single Switched Socket Outlet, 250V, 15A, deep curved - stainless steel.
A15/15NA	Single Switched Socket Outlet, 250V, 15A, deep curved, with shutter and neon - stainless steel.
A15M	Single Switched Socket Outlet Mechanism, 250V, 10A.
A15/15M	Single Switched Socket Outlet Mechanism, 250V, 15A.



A15NA



A15M

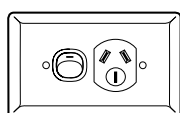

A15A

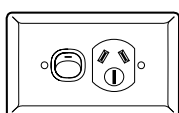

A15/15A

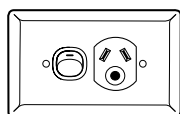

A15LA

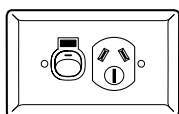

A15/15NA

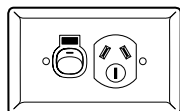

A15NA

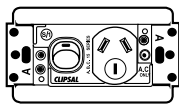

A15M

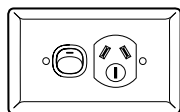

A15SA

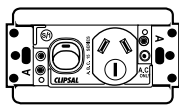

A15/15M

Metal Plate

Product Details

“A” Style Polished Brass Single Switched Socket Outlets - Horizontal Mounting

Catalogue No.	Length	Width	Depth	Mounting Centres
All Products	115mm	70mm	30mm	84mm apart

Description	
BA15A	Single Switched Socket Outlet. 250V, 10A, deep curved - polished brass.
BA15/15A	Single Switched Socket Outlet. 250V, 15A, deep curved - polished brass.



BA15A



BA15/15A

“A” Style Stainless Steel Lockable Switched Socket Outlets - Horizontal Mounting

Catalogue No.	Length	Width	Depth	Mounting Centres
All Products	115mm	70mm	45mm	84mm apart

Description	
A15YA	Single Switched Socket Outlet. 250V, 10A, deep curved, lockable flap on socket. Front projection with flap closed is 27mm. Hole for padlock is 8mm diameter - stainless steel.



A15YA

'B' and 'BSL' Style Stainless Steel Single Switched Socket Outlets - Horizontal Mounting

Catalogue No.	Length	Width	Depth	Mounting Centres
BSL15A, BSL15XA	130mm	85mm	35mm	84mm apart
B15LA, B15NA, B15/15A	115mm	70mm	30mm	84mm apart
B15M, B15/15M, B15LM	95mm	55mm	32.5mm	84mm apart



BSL15A

Description	
BSL15A	Single Switched Socket Outlet, 250V, 10A, flat plate, stainless steel fascia. Cut out: 76mm L x 43mm W.
BSL15XA	Single Switched Socket Outlet, with extra removable switch, 250V, 10A, flat plate, stainless steel fascia. Cut out: 77mm L x 53mm W.
B15LA	Single Switched Socket Outlet, 250V, 10A, flat plate, with round Earth pin, stainless steel fascia.
B15NA	Single Switched Socket Outlet, 250V, 10A, flat plate, with safety shutter and neon, stainless steel fascia.
B15/15A	Single Switched Socket Outlet, 250V, 15A, flat plate, stainless steel fascia.
B15M	Single Switched Socket Outlet Mechanism, 250V, 10A.
B15/15M	Single Switched Socket Outlet Mechanism, 250V, 15A.
B15LM	Single Switched Socket Outlet Mechanism, 250V, 10A, with round Earth pin.



B15LA



B15/15M

Note: neons, shutters, round Earth, 15A and socket outlet mechanisms are available only in the B Series (not BSL).

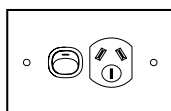

BSL15A

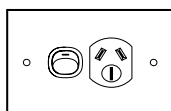

B15/15A

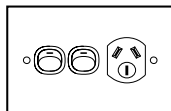

BSL15XA

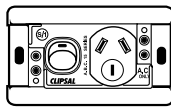

B15M

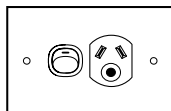

B15LA

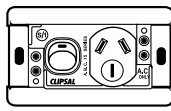

B15/15M

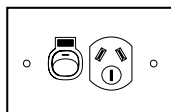

B15NA

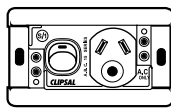

B15LM

Metal Plate

Product Details

'BB' and 'BBSL' Style Polished Brass Single Switched Socket Outlets - Horizontal Mounting

Catalogue No.	Length	Width	Depth	Mounting Centres
BBSL15A BBSL15XA	130mm	86mm	28mm	84mm apart
BB15LA , BB15/15A	115mm	70mm	30mm	84mm apart



BBSL15A



BBSL15XA



BBSL15XA



BB15/15A

Description	
BBSL15A	Single Switched Socket Outlet, 250V, 10A, flat plate, polished brass fascia. Cut out: 76mm L x 43mm W.
BBSL15XA	Single Switched Socket Outlet, 250V, 10A, flat plate, with extra removable switch, polished brass fascia. Cut out: 77mm L x 53mm W.
BB15LA	Single Switched Socket Outlet, 250V, 10A, flat plate, with round Earth pin, polished brass fascia.
BB15/15A	Single Switched Socket Outlet, 250V, 15A, flat plate - polished brass.

'A' Style Stainless Steel Twin Switched Socket Outlets - Horizontal Mounting

Catalogue No.	Length	Width	Depth	Mounting Centres
All Products	130mm	86mm	28mm	84mm apart

Description	
A25A	Twin Switched Socket Outlet, 250V, 10A, deep curved, stainless steel fascia.
A25NA	Twin Switched Socket Outlet, 250V, 10A, deep curved, with safety shutters and neons, stainless steel fascia.
A25SA	Twin Switched Socket Outlet, 250V, 10A, deep curved, with safety shutters, stainless steel fascia.
A25X	Twin Switched Socket Outlet, 250V, 10A, deep curved, with extra switch, stainless steel fascia.



A25A



A25NA



A25SA



A25X

Metal Plate

Product Details

'A' Style Polished Brass Twin Switched Socket Outlets - Horizontal Mounting

Catalogue No.	Length	Width	Depth	Mounting Centres
All Products	130mm	86mm	28mm	84mm apart

Description	
BA25A	Twin Switched Socket Outlet, 250V, 10A, deep curved, polished brass fascia.
BA25NA	Twin Switched Socket Outlet, 250V, 10A, deep curved, with safety shutters and neons, polished brass fascia.
BA25SA	Twin Switched Socket Outlet, 250V, 10A, deep curved, with safety shutters, polished brass fascia.
BA25X	Twin Switched Socket Outlet, 250V, 10A, deep curved, with extra switch, polished brass fascia.



BA25A



BA25NA



BA25SA



BA25X

'B' and 'BSL' Style Stainless Steel Twin Switched Socket Outlets - Horizontal Mounting

Catalogue No.	Length	Width	Depth	Mounting Centres
All Products	130mm	86mm	35mm	84mm apart

Description	
BSL25A	Twin Switched Socket Outlet, 250V, 10A, flat plate, stainless steel fascia.
B25NA	Twin Switched Socket Outlet, 250V, 10A, flat plate, with safety shutters and neons, stainless steel fascia.
B25SA	Twin Switched Socket Outlet, 250V, 10A, flat plate, with safety shutters, stainless steel fascia.
BSL25XA	Twin Switched Socket Outlet, 250V, 10A, flat plate, with extra removable switch, stainless steel fascia.

Recommended cut outs: BSL25A 77mm L x 57mm W
BSL25XA 112.5mm L x 73.5mm

BSL25A can be mounted on standard mounting accessories. However, B25SA, B25NA and BSL25XA require the 154B25 mounting bracket for installation (order separately). 15A models are available upon request.



BSL25A



B25NA



B25SA



BSL25XA

Metal Plate

Product Details

'BB' and 'BBSL' Style Polished Brass Twin Switched Socket Outlets - Horizontal Mounting

Catalogue No.	Length	Width	Depth	Mounting Centres
All Products	130mm	86mm	35mm	84mm apart

Description	
BBSL25A	Twin Switched Socket Outlet, 250V, 10A, flat plate, polished brass fascia.
BB25NA	Twin Switched Socket Outlet, 250V, 10A, flat plate, with safety shutters and neons, polished brass fascia.
BB25SA	Twin Switched Socket Outlet, 250V, 10A, flat plate, with safety shutters, polished brass fascia.
BBSL25XA	Twin Switched Socket Outlet, 250V, 10A, flat plate, with removable extra switch, polished brass fascia.

Recommended cut outs: BBSL25A 77mm L x 57mm W
BBSL25XA 112.5mm L x 73.5mm W

BBSL25A can be mounted on standard mounting accessories. However, BB25SA, BB25NA and BBSL25XA require the 154B25 mounting bracket for installation (order separately). 15A models are available upon request.



BBSL25A



BB25NA



BB25SA



BBSL25XA

'B' Style Stainless Steel Universal Shaver Outlets - Horizontal Mounting

Catalogue No.	Length	Width	Depth	Mounting Centres
All Products	186mm	95mm	90mm*	L157 x W64mm (fascia)

Description	
B727H	Universal Shaver Outlet, 240V-110V, includes 727VHB wall box, flat plate, stainless steel fascia.

Note: without wall box the depth is 70mm, wall box mounting centres are 152mm apart. There is also a grid frame between the wall box and the front fascia plate. Stainless steel depth is 1.6mm.



B727H

'B' Style Stainless Steel RCD Protected Shaver Outlets - Horizontal Mounting

Catalogue No.	Length	Width	Depth	Mounting Centres
All Products	216mm	146mm	70mm	L180mm x W104mm (fascia)*

Description	
B727EL	Universal Shaver Outlet, 240V-110V, with 30mA RCD protection, includes B727EL-5 wall box, flat plate, stainless steel fascia.

Wall box mounting centres are L180mm x 84mm apart, wall box measures L197 x W122 x D58mm. There is also a grid frame between the wall box and the front fascia plate. Stainless steel fascia depth is 1.6mm.



B727EL

Metal Plate

Product Details

'A' Style Stainless Steel Single Switched Socket Outlets - Vertical Mounting

Catalogue No.	Length	Width	Depth	Mounting Centres
A15VA, A15V15A,	115mm	70mm	35mm	84mm apart*
A15VM	105mm	55mm	28mm	84mm apart

Description	
A15VA	Single Switched Socket Outlet, 250V, 10A, deep curved, stainless steel fascia.
A15V15A	Single Switched Socket Outlet, 250V, 15A, deep curved, stainless steel fascia.
A15VM	Single Switched Socket Outlet Mechanism, 250V, 10A.

* Cover plate mounting centres are 30mm apart



A15VA



A15V15A



A15VM

'A' Style Polished Brass Single Switched Socket Outlets - Vertical Mounting

Catalogue No.	Length	Width	Depth	Mounting Centres
All Products	115mm	70mm	35mm	84mm apart

Description	
BA15VA	Single Switched Socket Outlet, 250V, 10A, deep curved, polished brass fascia.



BA15VA

'B' Style Stainless Steel Single Switched Socket Outlets - Vertical Mounting

Catalogue No.	Length	Width	Depth	Mounting Centres
B15VA, B15VLA, B15VNA, B15V15A,	115mm	70mm	35mm	84mm apart*
B15VM	95mm	55mm	32.5mm	84mm apart

Description	
B15VA	Single Switched Socket Outlet, 250V, 10A, flat plate, stainless steel fascia.
B15VLA	Single Switched Socket Outlet, 250V, 10A, flat plate, with round earth pin, stainless steel fascia.
B15VNA	Single Switched Socket Outlet, 250V, 10A, flat plate, with safety shutters, neon, stainless steel fascia.
B15V15A	Single Switched Socket Outlet, 250V, 15A, flat plate, stainless steel fascia.
B15VM	Single Switched Socket Outlet Mechanism, 250V, 10A.

Recommended cut outs: 96mm L x 56mm W.

* Cover plate mounting centres are 30mm apart



B15VA



B15VLA



B15VNA



B15V15A



B15VM

'B' Style Polished Brass Single Switched Socket Outlets - Vertical Mounting

Catalogue No.	Length	Width	Depth	Mounting Centres
All Products	115mm	70mm	35mm	84mm apart

Description	
BB15VA	Single Switched Socket Outlet, 250V, 10A, flat plate, polished brass fascia. Cut outs: 96mm L x 56mm W.



BB15VA

Metal Plate

Product Details

'B' Style Stainless Steel Twin Switched Socket Outlets - Vertical Mounting

Catalogue No.	Length	Width	Depth	Mounting Centres
All Products	115mm	115mm	35mm	84mm apart (2 sets)

Description	
B15V2A	Twin Switched Socket Outlet, 250V, 10A, flat plate, stainless steel fascia.
B15V2NA	Twin Switched Socket Outlet, 250V, 10A, flat plate, with safety shutters and neons, stainless steel fascia.
B15V2SA	Twin Switched Socket Outlet, 250V, 10A, flat plate, with safety shutters and stainless steel fascia.
B15V2/15A	Twin Switched Socket Outlet, 250V, 15A, flat plate - stainless steel, stainless steel fascia.

Recommended cut outs: 104mm L x 96mm W.

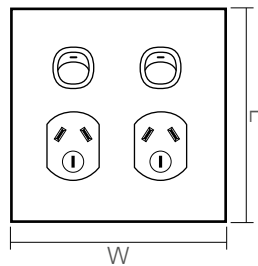

B15V2A



B15V2NA



B15V2SA



B15V2/15A

'B' Style Brass Twin Switched Socket Outlets - Vertical Mounting

Catalogue No.	Length	Width	Depth	Mounting Centres
All Products	115mm	115mm	35mm	84mm apart (2 sets)

Description	
BB15V2A	Twin Switched Socket Outlet, 250V, 10A, flat plate, polished brass fascia.
BB15V2SA	Twin Switched Socket Outlet, 250V, 10A, flat plate, with safety shutters, polished brass fascia.

Recommended cut outs: 104mm L x 96mm W.



BB15V2A

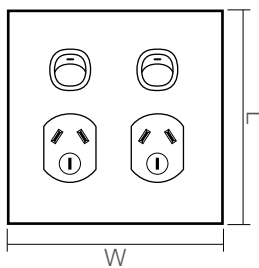

BB15V2SA

Metal Plate

Product Details



Mounting Accessories & Spacers

Generally, the single gang Metal Plate range of switches and switched sockets can be mounted to all Clipsal standard pattern mounting accessories. Unless using mounting accessories with recessed mounting centres (e.g. 157/1PRM Wall Box, 155PRM Mounting Bracket, 155NAR Nail Bracket or 154RM Wall Clip), the mounting accessory face should be set back 10mm (minimum) from the finished wall surface. This is necessary to allow 'B' style or some 'BSL' style grid plates and mechanisms to be located in the wall cavity between the plate underside and the mounting accessory.

As the 'A' style range has its grid plate assembly located predominantly in front of the wall surface, the need to set back any associated mounting accessories for this range is not required.

Wall Box Spacers

To assist in the correct positioning of wall boxes installed in poured concrete or plastered brickwork and to form a recess for mechanisms when using 'B' or some 'BSL' style plates, a range of wall box mounting spacers is available. They should be securely screw-fixed to the wall box before concrete is poured. The spacer should be removed and discarded before wiring 'B' or some 'BSL' style accessories.

The B15WBS is suitable for the complete range of 'B' style Single-Gang Standard Pattern mounting range of switches, and switched sockets. The B25WBS is suitable for the B25 Series Single Gang Standard Pattern Twin Switched Sockets and the BSL25XA Twin Switched Socket, with extra switch.

For further information on suitable mounting accessories, refer to the Mounting Accessories Cross Reference Guide located on pages 120 to 121.

'B' Style Wall Box Spacers

Catalogue No.	Length	Width	Depth	Mounting Centres
B15WBS	100mm	61mm	13mm	84mm apart
B25WBS	100mm	73mm	13mm	84mm apart

Description	
B15WBS	Spacer to suit B15 and B30 Series.
B25WBS	Spacer to suit B25 Series and BSL25XA.

Note: some of the Metal Plate Security range products with larger grid plates may also require the use of the B25WBS spacer. Consult your Clipsal Representative for more details.



B25WBS

Mounting Clips

The BSL25XA is supplied with an oversized rear grid plate. To assist with installing this product in cavity walls, it is recommended to use the 154B25 Wall Mounting Clip. The mounting clip sits behind the wall cavity when used in conjunction with longer mounting screws; it secures the BSL25XA firmly against the wall. Some custom 'BSL' products may also require a 154B25 Mounting Clip.

'B' Style Wall Box Spacers

Catalogue No.	Length	Width	Depth	Mounting Centres
154B25	110mm	96mm	20mm	84mm

Description	
154B25	Metal Wall Clip for cavity wall mounting of BSL25XA



154B25

Metal Plate

Product Details



Switch Mechanisms

Clipsal's unique "dolly" switch was developed in 1971 and proved to be a great leap forward. Unsatisfied with the hard lines of traditional switch rockers at the time, Clipsal engineers fashioned a more stylish alternative. The Standard range of switch and socket outlets was the first to use the new switch.

Over the years, this patented Clipsal switch has undergone very subtle changes to adapt to new technologies, plastics and designs. But to the naked eye the original design remains unchanged and is as strong today as it was many years ago. Today, you'll find the Clipsal switch shape in dozens of different switch models, ranging from the traditional 30M to the latest 30PB Push-Button, with blue LED. The following pages provide information on Clipsal's switch mechanism ranges.

For further information on labelled mechanisms refer to pages 58 to 59.

The shape of the switch "dolly" is a trademark (TM) of Clipsal by Schneider Electric.

Catalogue No.	Description
30M	250V/10A, 1-Way/2-Way. Terminal bores of 4.1mm ϕ accommodate 4 x 1.5mm ² or 3 x 2.5mm ² cables. Body fits 22mm ϕ hole. M rating is 100.
30MRD	250V/10A, 1-Way/2-Way with red dolly mark. Terminal bores of 4.1mm ϕ accommodate 4 x 1.5mm ² or 3 x 2.5mm ² cables. Body fits 22mm ϕ hole. M rating is 100.
30FLM	250V/10A, 1-Way/2-Way. Suits fluorescent loads. Terminal bores of 4.1mm ϕ accommodate 4 x 1.5mm ² or 3 x 2.5mm ² cables. Body fits 22mm ϕ hole. M rating is 120.
30USM	250V/20A 16AX. 1-way/2-way, universal rocker. Accommodates 4x 1.5mm ² cables or 3 x 2.5mm ² cables.



30M



30MRD



30FLM



30USM

Catalogue No.	Description
30RSM2	250V/15A, Rotary (2 On - 2 Off). Also suitable for 12V d.c. 15A, audio and control applications. Switch positions indicated in window. M rating is 50.
30RSM3	250V/15A, Rotary (3 On - 1 Off). Also suitable for 12V d.c. 15A, audio and control applications. Switch positions indicated in window. M rating is 50.



30RSM2

Catalogue No.	Description
30MCO	250V/10A, Changeover Double Throw (selects alternate circuits).
30MI	250V/10A, Intermediate. 4 terminals of 3.5mm ϕ accommodates 2 x 2.5mm ² cables. Body fits 22mm ϕ hole.



30MCO



30MI

Metal Plate

Product Details

Catalogue No.	Description
30MBP	440V/15A, Bell Press. Facility for momentary ON or OFF. 1 looping terminal.
30MBPN	250V/15A, Illuminated Bell Press. Facility for momentary ON or OFF. Neon is connected across terminals 1 and 4. Alternative lamp voltages available.
30MBPR	250V/10A Bell Press Rocker. Facility for momentary ON or OFF. Suitable for extra low voltage applications. 1 looping terminal.



30MBP



30MBPN



30MBPR

Catalogue No.	Description
30PB	250V/20 16AX, 1-Way/2-Way Push-Button (no LED indicator). Accommodates 4 x 1.5mm ² cables or 3 x 2.5mm ² cables
30PBBP	250V/16A, Momentary Push-Button (no LED indicator). Accommodates 4 x 1.5mm ² cables or 3 x 2.5mm ² cables
30PBI	250V/16A 10AX, Intermediate Push-Button. Accommodates 4 x 1.5mm ² cables or 3 x 2.5mm ² cables
30PBL	250V/20AMP 16AX, 1-Way/2-Way Push-Button (with blue LED indication). Accommodates 4 x 1.5mm ² cables or 3 x 2.5mm ² cables
30PBBPL	250V/16A, Momentary Push-Button (with LED indicator). Accommodates 4 x 1.5mm ² cables or 3 x 2.5mm ² cables



30PB



30PBBP



30PBI



30PBL



30PBBPL

Catalogue No.	Description
30MD	250V/10A, 1-Way Double Pole Single Throw. Terminal bores of 4.1mm ϕ accommodate 4 x 1.5mm ² or 3 x 2.5mm ² cables. Body fits 22mm ϕ hole. M rating is 90.
30HMD	250V/10A, Double Pole - marked HEAT.
30MD2	250V/10A, 2-Way, Double Pole Double Throw. 6 terminal bores of 4.1mm ϕ accommodate 4 x 1.5mm ² or 3 x 2.5mm ² cables. M rating is 75.
30MD15	250V/15A, 1-Way Double Pole Single Throw. Terminal bores of 4.1mm ϕ accommodate 4 x 1.5mm ² or 3 x 2.5mm ² cables. Body fits 22mm ϕ hole. M rating is 90.
30MD20	250V/20A, 1-Way Double Pole. 4 terminals of 1.5mm ϕ accommodate 3 x 2.5mm ² cables. Body fits 34mm ϕ hole. M rating is 100.
30M35	250V/35A, 1-Way/2-Way. Terminal bore of 3.6mm ϕ and looping terminal bore of 3.9mm ϕ . M rating is 160.



30MD



30MD2



30MD20



30HMD



30MD15



30M35

Catalogue No.	Description
30/1/2LM	250V/10A, 1-Way Rocker. 2 looping terminals. Terminal bores of 4.1mm ϕ accommodate 4 x 1.5mm ² or 3 x 2.5mm ² cables. Body fits 22mm ϕ hole. M rating is 100.
30/1ELM	250V/10A, 1-Way Rocker. 1 looping and 1 Earth terminal - terminal bores of 4.1mm ϕ accommodate 4 x 1.5mm ² or 3 x 2.5mm ² cables. Body fits 22mm ϕ hole. M100 rating
30/1NM	250V/10A, 1-Way Rocker (with neon indicator). Neon can be wired to indicate "ON", "OFF" or "POWER AVAILABLE". Looping/switch terminal bores of 4.1mm ϕ . Body fits 34mm ϕ hole (note: Neutral required).
30/2NM	250V/10A, 2-Way Rocker (with neon indicator). Neon can be wired to indicate "ON", "OFF" or "POWER AVAILABLE". Looping/switch terminal bores of 4.1mm ϕ . Body fits 34mm ϕ hole (note: Neutral not required if wiring neon to be permanently ON when load is OFF).
30/5M	250V/10A, 1-Way/2-Way Rocker. 5 terminals - 1 looping and 1 Earth terminal. Terminal bore for common, looping and Earth of 5.3mm ϕ - accommodates 4 x 2.5mm ² cables. Terminal bore for 1 and 2 of 4.1mm ϕ accommodates 4 x 1.5mm ² or 3 x 2.5mm ² cables. Body fits 26mm ϕ hole. M rating is 40.
30TKM	250V/20A (5A fluorescent load), 1-Way/2-Way Toggle Key Actuated. 1 looping terminal. M rating is 100.



30/1/2LM



30/1ELM



30/1NM



30/2NM



30/5M



30TKM

Catalogue No.	Description
39M	250V/10A, 3 Position. Labelled HI-OFF-LO. 3 terminals, 3.5mm ϕ . Accommodates 2 x 2.5mm ² cables
39MAOM	250V/10A, 3 Position. Labelled MAN-OFF-AUTO. 3 terminals, 3.5mm ϕ . Accommodates 2 x 2.5mm ² cables
39MSON	250V/10A, 3 Position. Labelled SENSOR-OFF-ON. 3 terminals, 3.5mm ϕ . Accommodates 2 x 2.5mm ² cables
39MUOD	250V/10A, 3 Position. Labelled UP-OFF-DOWN. 3 terminals, 3.5mm ϕ . Accommodates 2 x 2.5mm ² cables



39M



39MAOM



39MSON



39MUOD

Neon Indicator Mechanisms

Catalogue No.	Description
30N-RED	250V, Neon Indicator (red).
30N-COLOUR	250V, Neon Indicator (other colours).



30N-RED



30N-COLOUR

Metal Plate

Product Details

Dimmer, Fan Control and Surge Filter Mechanisms

Catalogue No.	Description
32E2CFLDM	C-Thru® Dimmer Mechanism, CFL. Suits dimmable compact fluorescent lamps, incandescent lighting, halogen/dichroic lamps, as well as low voltage lighting using iron core or electronic transformers. 220- 240V/300W.
32E450LM	C-Thru® Dimmer Mechanism, Leading Edge. Suits incandescent lighting and low voltage lighting using iron core transformers. 220- 240V/450W.
32E450TM	C-Thru® Dimmer Mechanism, Trailing Edge. Suits incandescent lighting and low voltage lighting using electronic transformers. 220- 240V/450W.
32E450UDM	C-Thru® Dimmer Mechanism, Universal. Suits incandescent lighting, halogen/dichroic lamps and low voltage lighting using iron core or electronic transformers. 220- 240V/450W. Also suitable to control small motor loads such as ceiling sweep and exhaust fans.
32E500FM	C-Thru® Fan Speed Controller Mechanism. 220-240V/500W.
30SFM	Surge Filter Mechanism, 250V 10A. Protects equipment from transient spikes or surges. Maximum clamping voltage (8/20µs, 100A) 710V.
31E2PUDM	Dimmer - Single Mechanism. Does not require separate switch. ON/OFF push-button, universal, 250V/350W.
31E2RUDM	Dimmer - Single Mechanism. Does not require separate switch. ON/OFF, rotary, universal, 250V/350W.



32E2CFLDM



32E450TM



32E500FM



31E2PUDM



32E450LM



32E450UDM



30SFM



31E2RUDM

C-Bus 30 Mechanism Wall Switches

Catalogue No.	Description
5031NMMIRL	IR capable C-Bus master mechanism for Clipsal 30 series aperture, gridplates and enclosures.
5031NMML	C-Bus master mechanism for Clipsal 30 series apertures, gridplates and enclosures.
5031NMS	C-Bus slave mechanism for Clipsal 30 series apertures, gridplates and enclosures.



5031NMMIRL



5031NMML



5031NMS

Switch Mechanism Mounting Accessories

The following mounting accessories are used for mounting mechanisms in a panel or enclosure. The B30GFZ Mounting Clip is a standard and crucial component of the multi-gang grid assemblies and is held in by fixing screws. The P30GFZ and 539 Mounting Clips are also anchored by fixing screws. However, the F30Z Series is a range of mounting clips that 'push-fit' into panel apertures.

Circuit Identification and Blanking Products

Catalogue No.	Description
B30GFZ	Mounting Clip with Moulded Surround. Suits 30 Series Mechanisms. 36mm mounting centres for outer fixing screws.
P30GFZ	Mounting Clip with Moulded Surround. Suits P30 Series Mechanisms. 55.6mm diagonal mounting centres for fixing screws.
539	Mounting Clip with Moulded Surround. Suits PDL 500/600 Series Mechanisms. 40mm mounting centres for fixing screws.
F30Z1	Mounting Clip. Suits 1mm thick sheet.
F30Z1.5	Mounting Clip. Suits 1.5mm thick sheet.
F30Z2	Mounting Clip. Suits 2mm thick sheet.
F30Z4	Mounting Clip. Suits 4mm thick sheet.



B30GFZ



P30GFZ



539



F30Z1



F30Z1.5



F30Z2



F30Z4

Circuit Identification Products

Clipsal offers a range of blanking plugs for circuit identification products to provide added flexibility, safety and secure labelling.

Circuit Identification and Blanking Products

Catalogue No.	Description
30P	Removable Blank Plug to suit or blank out 30 Series aperture
30PFO	Plug labelled FRIDGE - FREEZER ONLY.
30PID	30 Series ID Circuit Plug - tamper proof.
30PIDA4L*	Sheets, 10 x A4 packet, available in white only (non-adhesive).

*Software for printing these Label Sheets is available on the Clipsal eCatalogue



30P



30PFO



30PID



30PIDA4L

Metal Plate

Product Details

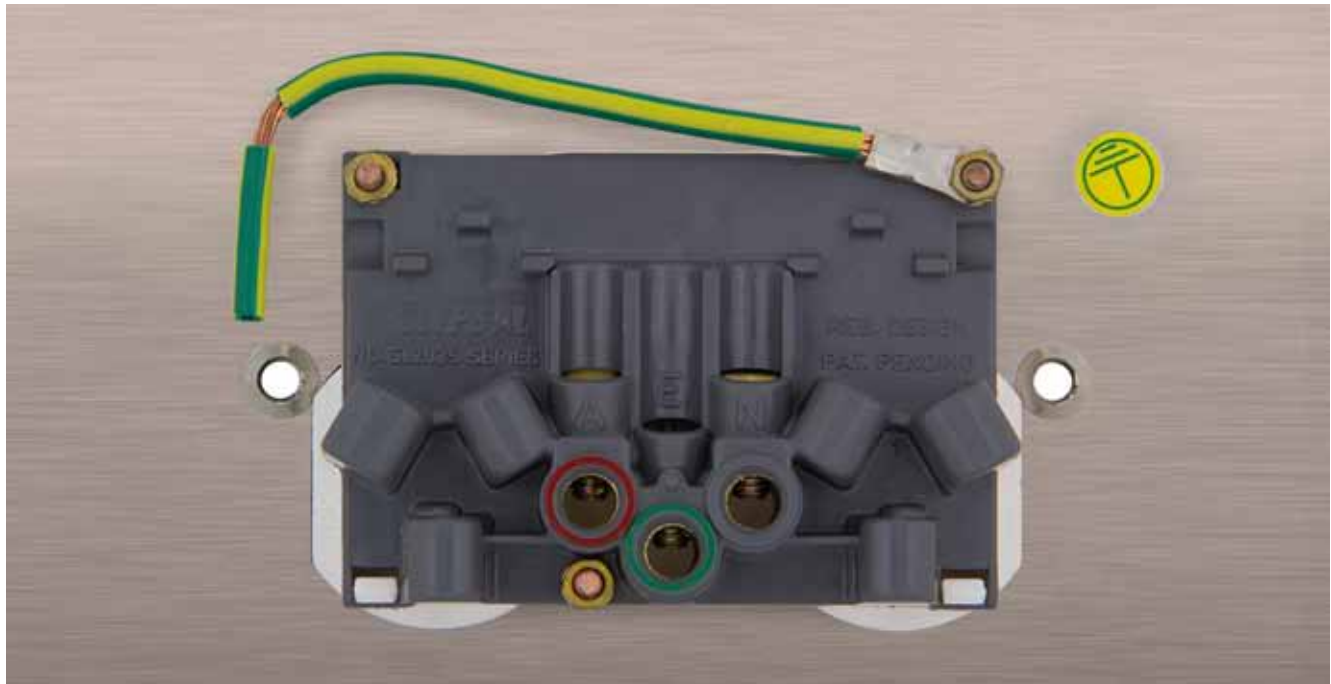

Safety & Cleaning Guidelines

Installation Safety

All electrical products should be installed by a licensed electrician to Australian and New Zealand Wiring Rules AS/NZS 3000.

Earthing Safety

Where required Metal Plate products are provided with Earthing points to ensure safety requirements are met. For example: either a crimp lug or crimp lug with Earth strap are provided on the back of BSL cover plates.

Cleaning Guidelines

It is not recommended to spray cleaning products directly on to electrical switches or sockets. Before applying ensure that switches or sockets are isolated (switched off). Cleaning sprays should be sprayed onto a clean cloth before applying to the cover plate. Do not use any cleaning sprays on moulded parts, such as switches or sockets - only wipe down with damp or dry cloth.

Stainless Steel

When cleaning Metal Plate, stainless steel abrasive cleaners (e.g. Silvo) should not be used. The Stainless Steel Metal Plate range can be cleaned by approved products such as 3M™ Stainless Steel Cleaner and Polish. It leaves behind a light protective film to reduce fingerprints and smudges. It also leaves a streak-free finish.



Polished Brass

The polished brass Metal Plate range is specially coated to prevent tarnishing. The coating protects the polished brass finish and eliminates the need for polishing.

To clean the plate, simply wipe with a wax based cleaner (e.g. Mr. Sheen). Under no circumstances use abrasive cleaners (either liquid or powder), brass polish (e.g. Brasso), or solvent cleaners. Such use could result in surface damage and tarnishing may occur.



Plastic Mouldings

The majority of the Metal Plate products are supplied with plastic grid assemblies, which are resistant to most common chemicals and cleaning agents. For more information please contact your Clipsal Representative.



Metal Plate

Wiring & Connection Diagrams

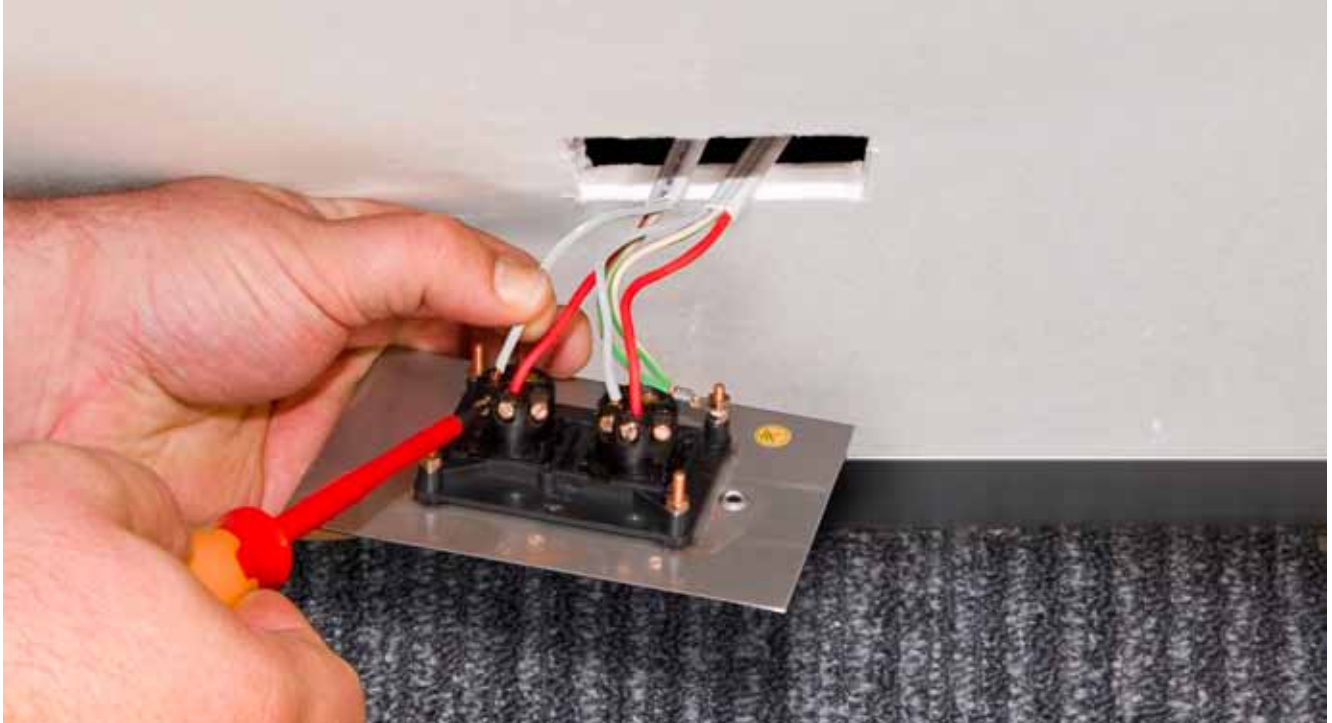

Wiring and Connection Diagrams

Clipsal Mechanisms provide the flexibility to control various loads, particularly in residential or commercial applications. The terminal designs come in an array of shapes and sizes with the majority fitting into the Metal Plate Switch range. Allowance must always be made for wiring space and where required (e.g. dimming) derating of mechanisms.

The following pages provides connection guidelines are so that electrical contractors can determine the suitability of certain mechanisms for specific applications. These wiring and connection methods are to be used as a guide only. It is paramount that selection and installation of these mechanisms comply with local wiring regulations.

For more information on Clipsal Mechanisms, please contact your local Clipsal Sales Office or Representative.

30 Series Switch Mechanism, 10A, 250V a.c.

One-Way Switching

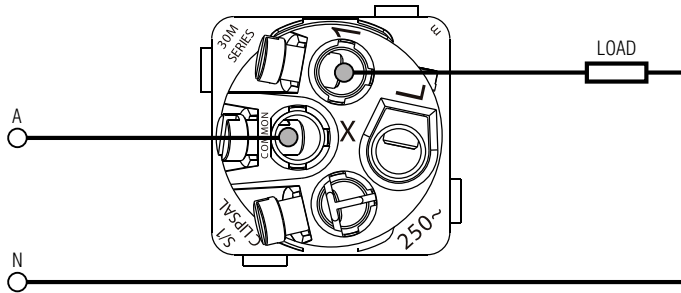

30M, 30FLM

Two-Way Switching

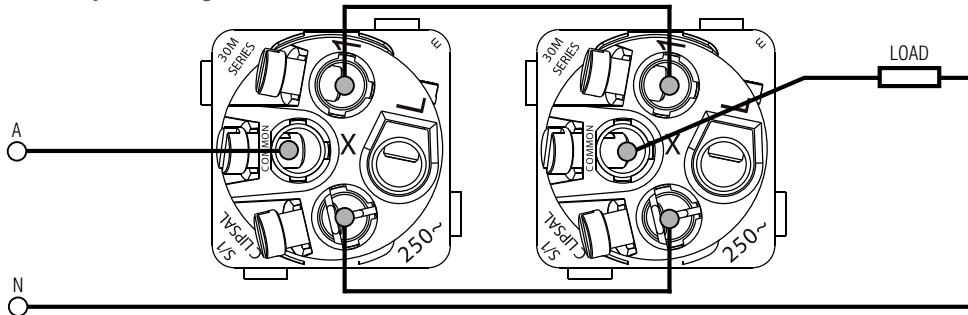

Universal Switch Mechanism, 20A/16AX, 250V a.c.

One-Way Switching

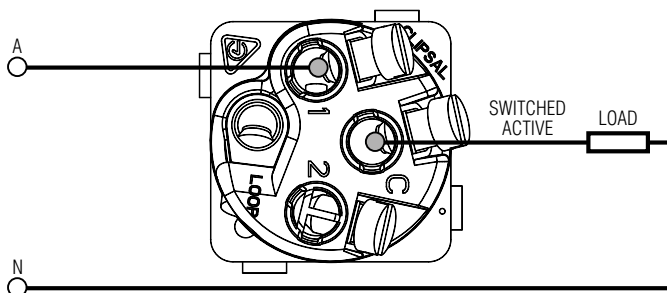

30USM

Two-Way Switching

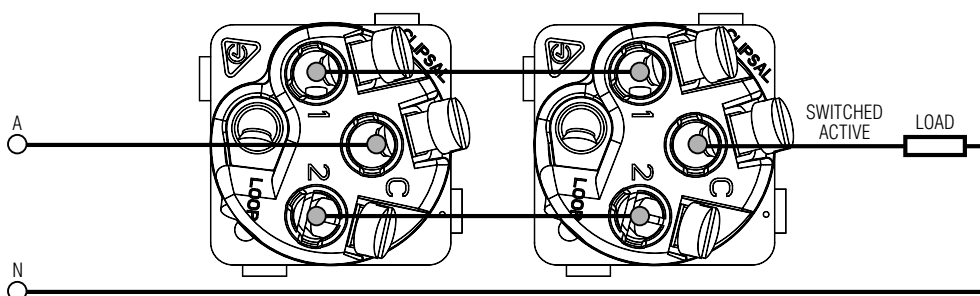

Metal Plate

Wiring & Connection Diagrams

Impress Push-Button Mechanism, 20A/16AX, 250V a.c.

No LED fitted - load OFF permanently, ON momentarily

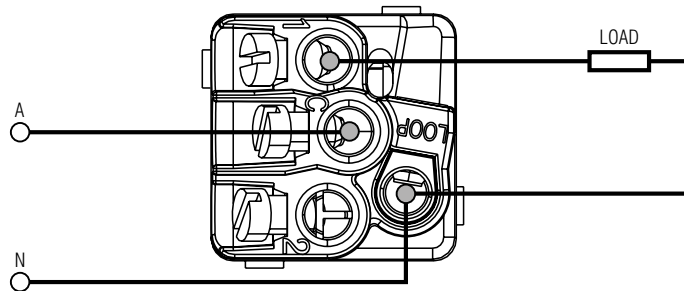

30PB

No LED fitted - load ON permanently, ON momentarily

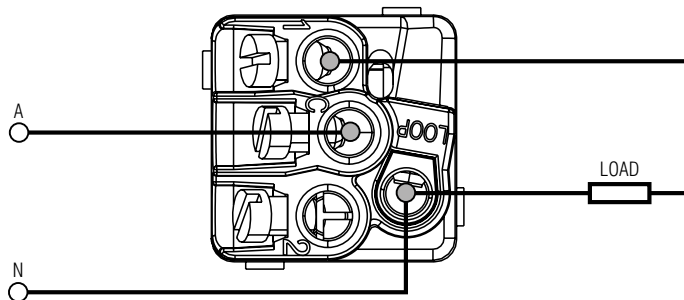

Impress Push-Button Mechanism with LED, 20A/16AX, 250V a.c. One-Way Switching

LED fitted - load OFF permanently, ON momentarily

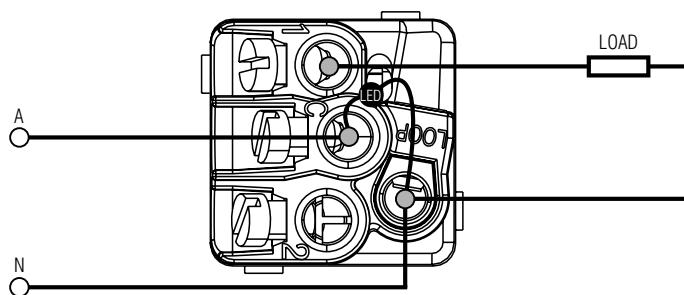

30PBL

LED fitted - load ON permanently, ON momentarily

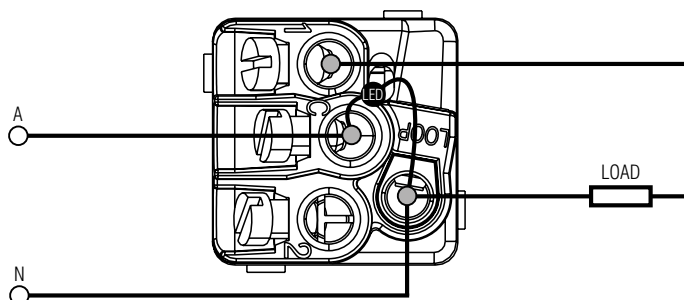

Impress Push-Button Mechanism, 20A/16AX, 250V a.c.

Two-Way Switching, No Neutral Present LED 'ON' Switch 'OFF'

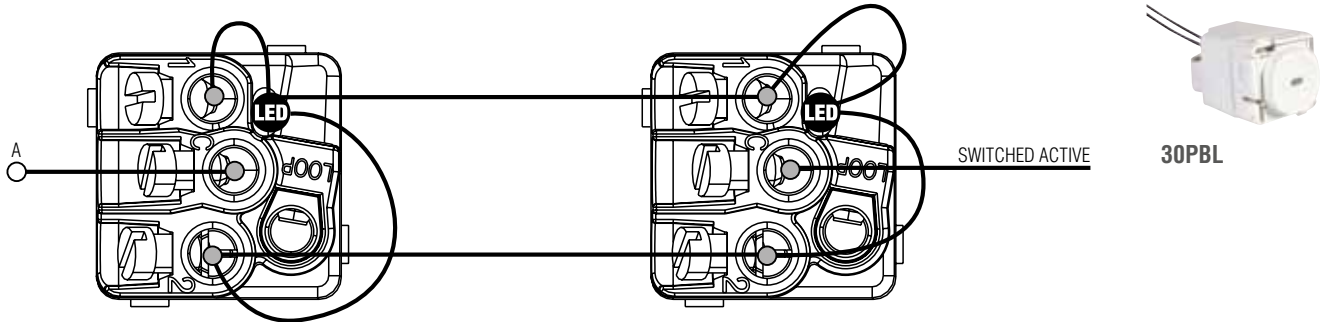

Impress Push-Button Mechanism, 20A/16AX, 250V a.c.

Two-Way Switching, Neutral Present at the Switch LED 'ON' Switch 'ON'

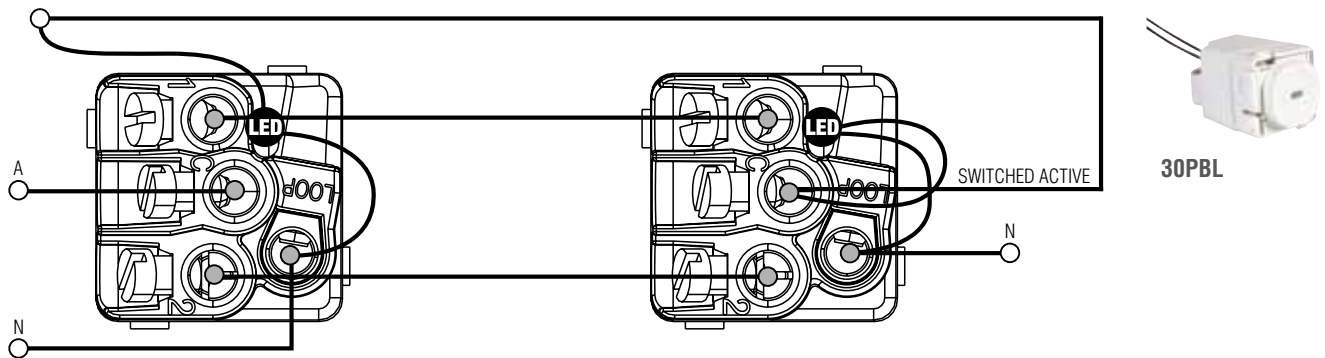

Impress Push-Button Mechanism, 20A/16AX, 250V a.c.

Two-Way Switching, Neutral Present at the Switch LED 'ON' Switch 'OFF'

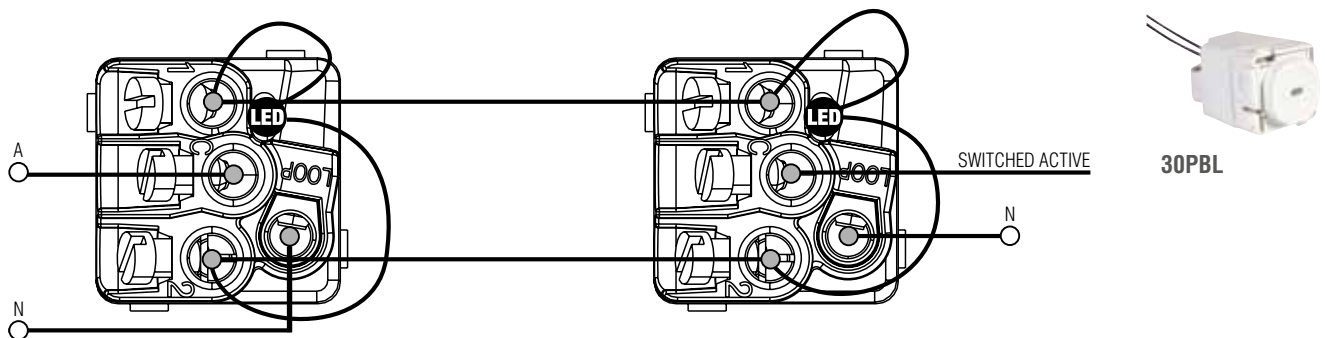

Metal Plate

Wiring & Connection Diagrams

Double Pole, Single Throw One-Way Mechanism, 10A/16AX, 250V a.c.

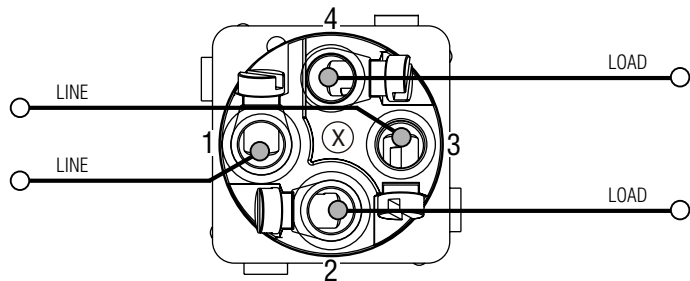

Double Pole, Double Throw Two-Way Mechanism, 10A/16AX, 250V a.c.

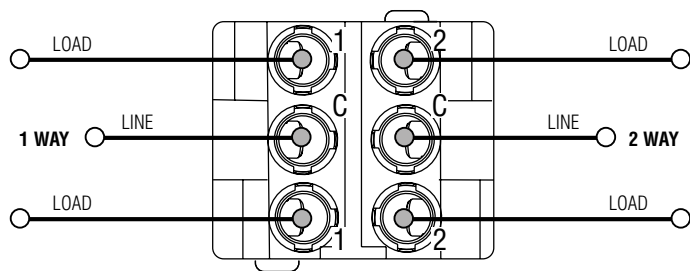

Double Pole, One-Way Mechanism, 20A ,250V a.c.

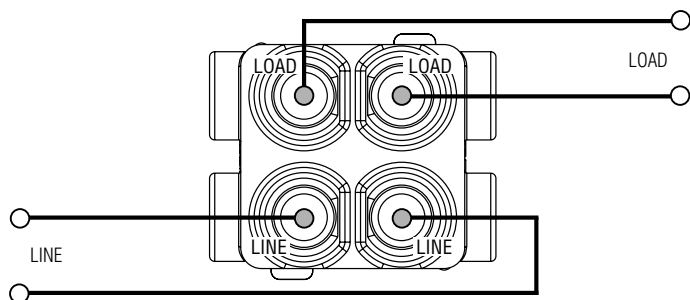

Intermediate Switch Mechanism, 10A, 250V a.c.

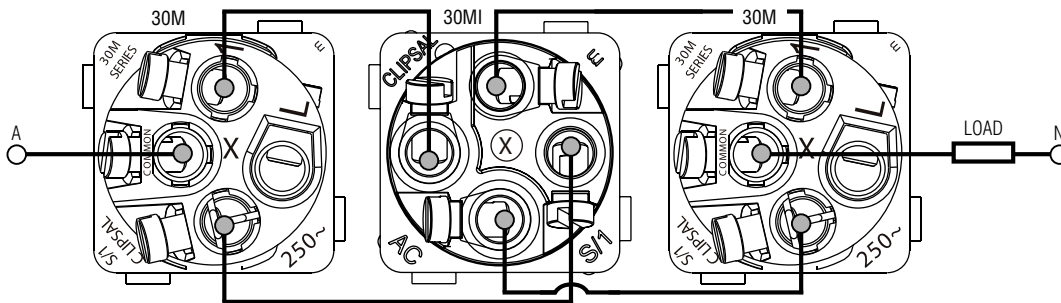

30MI

Changeover Switch Mechanism, 10A, 250V a.c.

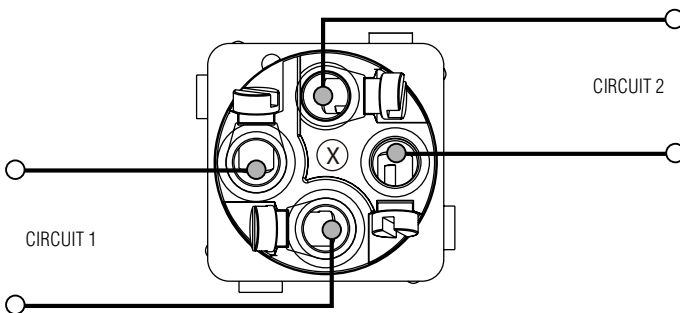

30MCO

Three Position Switch Mechanism, Marked HI-OFF-LO

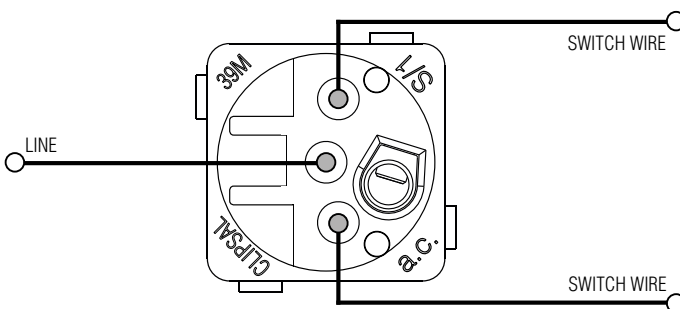

39M

Metal Plate

Wiring & Connection Diagrams

Rotary Switch Mechanism, (2 ON, 2 OFF), 15A, 250V a.c.

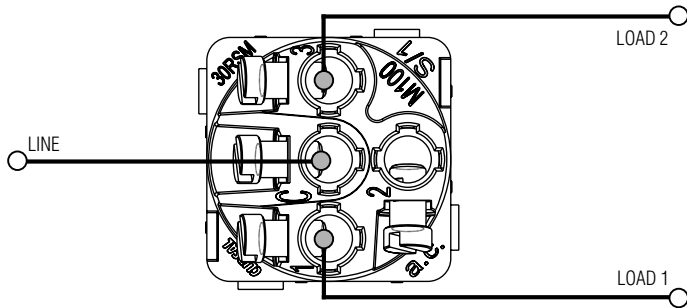

30RSM2

Rotary Switch Mechanism, (3 ON, 1 OFF), 15A, 250V a.c.

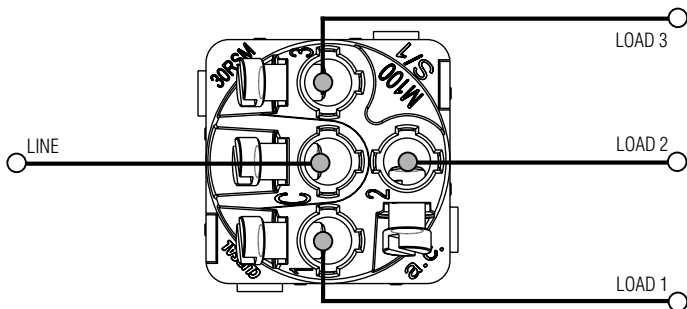

30RSM3

Three Position Switch Mechanism, Marked AUTO-OFF-MAN

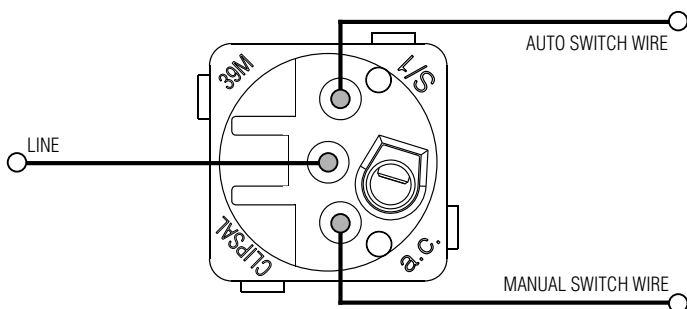

39MAOM

One-Way / Two-Way Switch Mechanism with Dimmer/Fan Controller

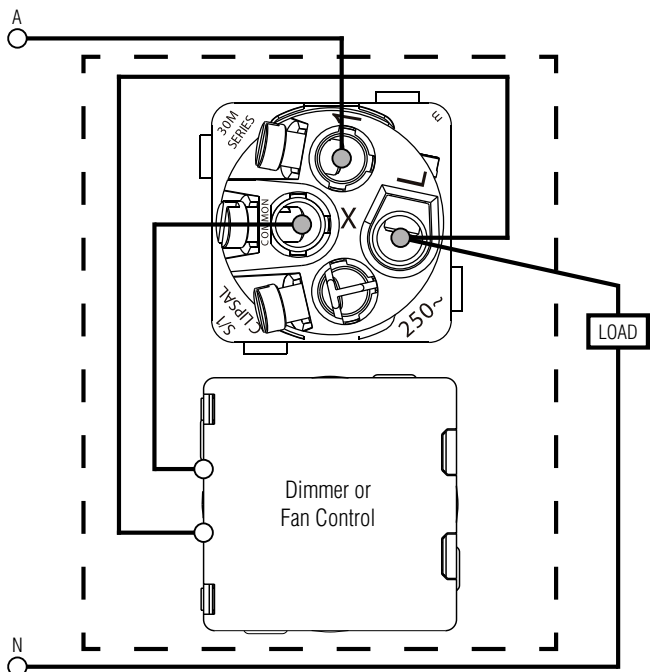

32E450UDM



32E450TM



32E450LM



32E2CFLDM



32E500FM

Note: all C-Thru™ dimmer plate variants are supplied with a 30/1/2LM switch mechanism. This mech is designed to be reconfigurable.
Default state: 1-way with two looping terminals (marked LOOP and 2).
Alternative state: 2-way with one looping terminal (marked LOOP).
To change over, remove terminal screws and interchange 2 and LOOP terminal poles/contacts. Reinsert screws and terminate wiring as usual.

One-Way Switch Mechanism with Two Load Terminals (30/1/2LM)

One-Way Switch Mechanism with One Earth and One Loop Terminal (30/1ELM)

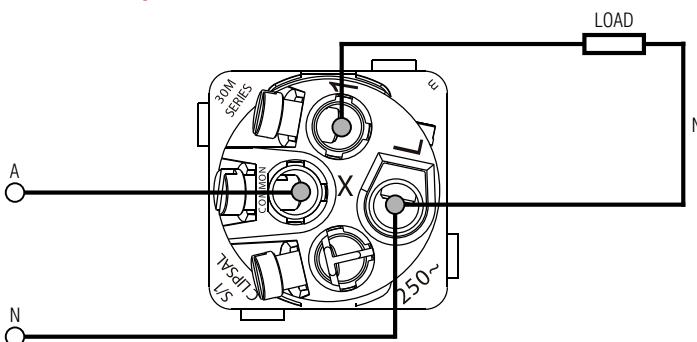

30/1/2LM
30/1ELM

One-Way / Two-Way Switch Mechanism with Five Load Terminals

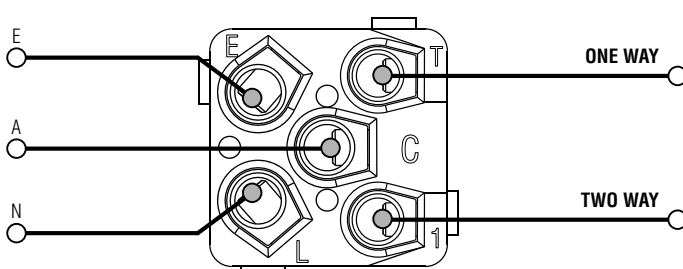

30/5M

Metal Plate

Wiring & Connection Diagrams

One-Way Mechanism with Neon Indicator

To wire neon permanently ON

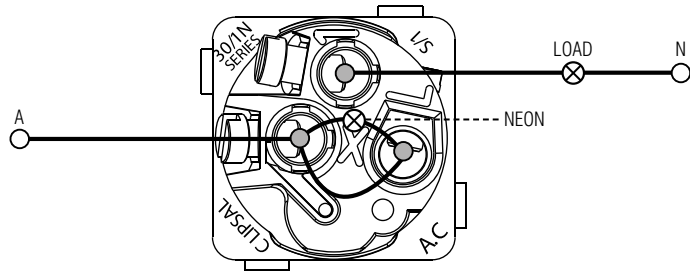

30/1NM

To wire neon ON when switch OFF

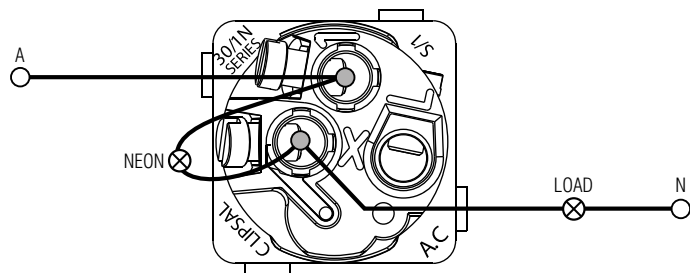

To wire neon ON when switch ON

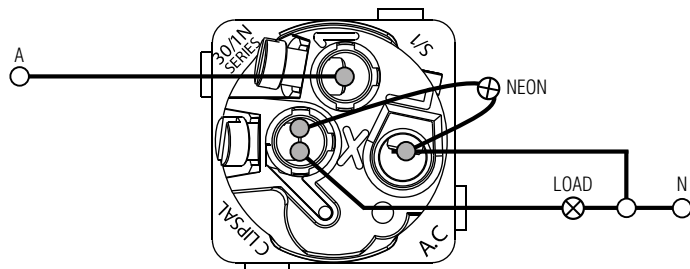

Two-Way Mechanism with Neon Indicator

To wire neon permanently ON

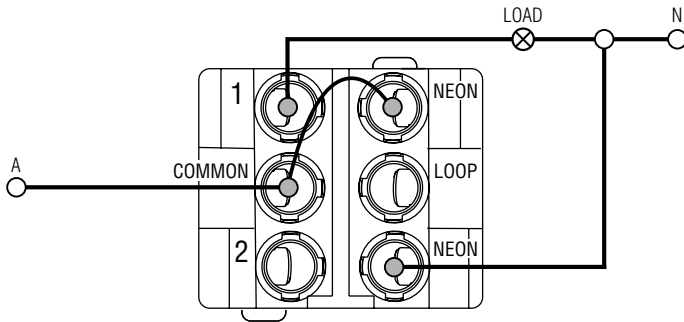

30/2NM

To wire switch ON when switch OFF

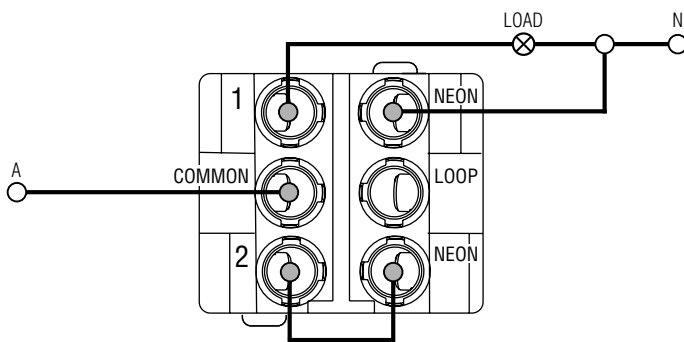

To wire neon ON when switch ON

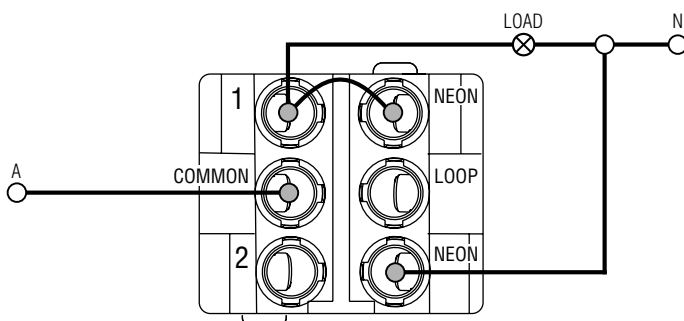

Metal Plate

Wiring & Connection Diagrams

Two-Way Mechanism with Neon Indicator

Two-way switching, to wire neon ON when load is ON

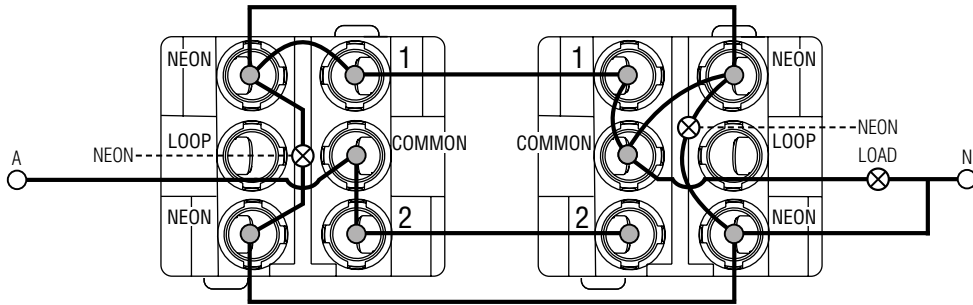

30/2NM

Two-way switching, to wire neon ON when load is OFF

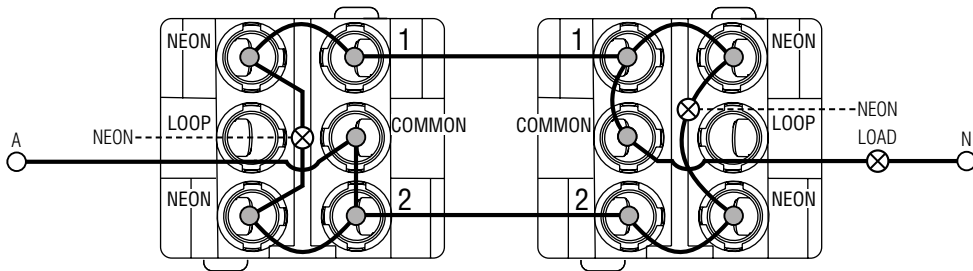

Twin Switched Socket with Extra Switch, 10A, 250V a.c.

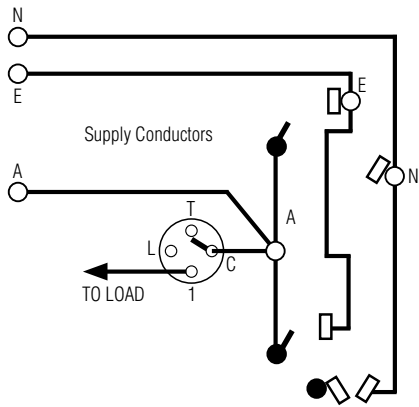

BSL25XA

Twin Vertical Switched Socket, 10A, 250V a.c.

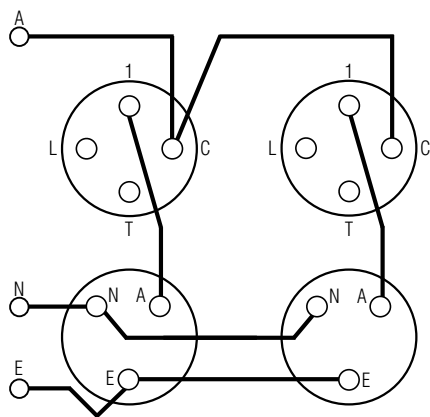

B15V2A

Metal Plate

Medilec Range



Medilec Range

Clipsal Medilec provides a wide range of electrical equipment for patient treatment areas of hospitals, medical and dental practices.

The Medilec range of medical electrical accessories and electrical safety equipment is specifically developed to suit the specialised requirements of the medical industry.

This includes the design, development and manufacturing of residual current devices (RCDs), line isolation and overload monitors (LIOMs), medical service panels, isolation transformers, equipotential junctions and RCD protected power outlets.

Medilec products have become a key component in many landmark hospitals across Australia. Some of these include The Prince Charles Hospital, QLD; Joondalup Public Hospital, WA; Launceston General Hospital, Tasmania; Warrnambool Hospital, Victoria; Royal Children's Hospital, Melbourne; Royal Adelaide Hospital, SA; and the Mater Mothers' Hospitals, Brisbane - just to name a few.

The following pages provide an overview of metal finishes for the Clipsal Health Solutions range. For further details on the Medilec product range go to clipsal.com or contact your local Clipsal Representative.

Bedhead Panels

Medical service panel (MSP) systems are a convenient way of providing bedhead access to services such as power, data, nurse call, medical gas and climate control to patients and medical staff.

The latest generation ML2144, ML2164, ML2165 (and ML2000 Series) MSPs have been developed to meet the current needs of hospitals, which now require less intimidating surroundings and a more relaxed environment. They are also suitable for dental practices, aged care facilities, medical clinics and laboratories.

ML2164 Series Flush Mounted Metal Plate System

The ML2164 Series fits standard Medilec Wall Boxes and Grids, which can easily be joined together to produce custom length MSPs to suit specialised requirements. This allows for custom wall box assemblies incorporating grids and accessories to be supplied in appropriate time frames.



ML2144 Series Surface Mounted Metal Plate System

The ML2144 Series can be fitted to a variety of joinery profiles and mounted onto a mounting enclosure constructed by the builder using MDF or similar materials. When compared to typical aluminium extruded or sheet metal surface mounted trunking systems, there is a significant reduction in costs, while still maintaining an attractive surface mounted enclosure.



ML2165 Series Surface Mounted Metal Plate System

The ML2165 Series fits standard Medilec grid plates, with a box that can be quickly modified from pre-cut 2.4m lengths to produce custom length MSPs, suiting the customer's specific requirements. This unique design allows for installation post wall construction, which means the MSP can be supplied fully assembled. This eliminates partial deliveries, and the product can be installed in one operation.



Metal Plate

Medilec Range



Medi-Plus Surface Mount Ducted Systems

The Medi-Plus Series Surface Mount Duct System incorporates Clipsal 2000 Series Accessories and complementary products manufactured by other companies, into aluminium extruded duct.

It allows the customer to purchase all components as pre-made stocked items and the product can be constructed on-site to suit the required application. Surface Mounted Duct Systems are also available pre-assembled to suit the customer's specific requirements. The advantage of this duct system is that the services, such as gas piping and wiring, run within the trunking and not inside the wall cavity, reducing the amount of wall preparation.

There is a choice of fascia finishes and colours, including high-grade stainless steel, natural anodised and powder coated finish. All duct incorporates three segregated service channels. The ducting can also be semi-recessed to give a flush appearance and its sloping face reduces dust collection.

ESP Series Surface Mounted Duct System

The ESP Surface Mounted Duct System incorporates ESP electrical accessories and a variety of Clipsal accessories, as well as products manufactured by other companies, into aluminium extruded duct.

Like the ESP Surface Mounted Trunking System, the advantage of this duct system is that the services (gas piping and wiring) run within the trunking and not the wall cavity, reducing the amount of wall preparation.

The ESP system offers a choice of fascia finishes and colours, including high-grade stainless steel and powder coated finish. It also incorporates three segregated service channels.



ESP Series Flush & Surface Mount Metal Plate System

Both ESP Flush Mount and Surface Mount Metal Plate solutions are typically fitted with ESP electrical accessories, but can also incorporate a variety of Clipsal Accessories, as well as products manufactured by other companies. They can be flush or surface mounted and are available in a choice of fascia finishes and colours, including high-grade stainless steel and powder coated finish. They also have the ability to integrate Clipsal accessories, nurse call systems, and gas outlets. In addition, the ESP Series offers recessed wall boxes that incorporate fascia height adjusters, ensuring flush fitting and correct alignment.

For more information on the Clipsal Health Solutions range, please refer to the Medilec Hospital Solutions brochure. Alternatively, go to clipsal.com or contact your Clipsal Representative.



Metal Plate

Alternative Products with Metal Finishes

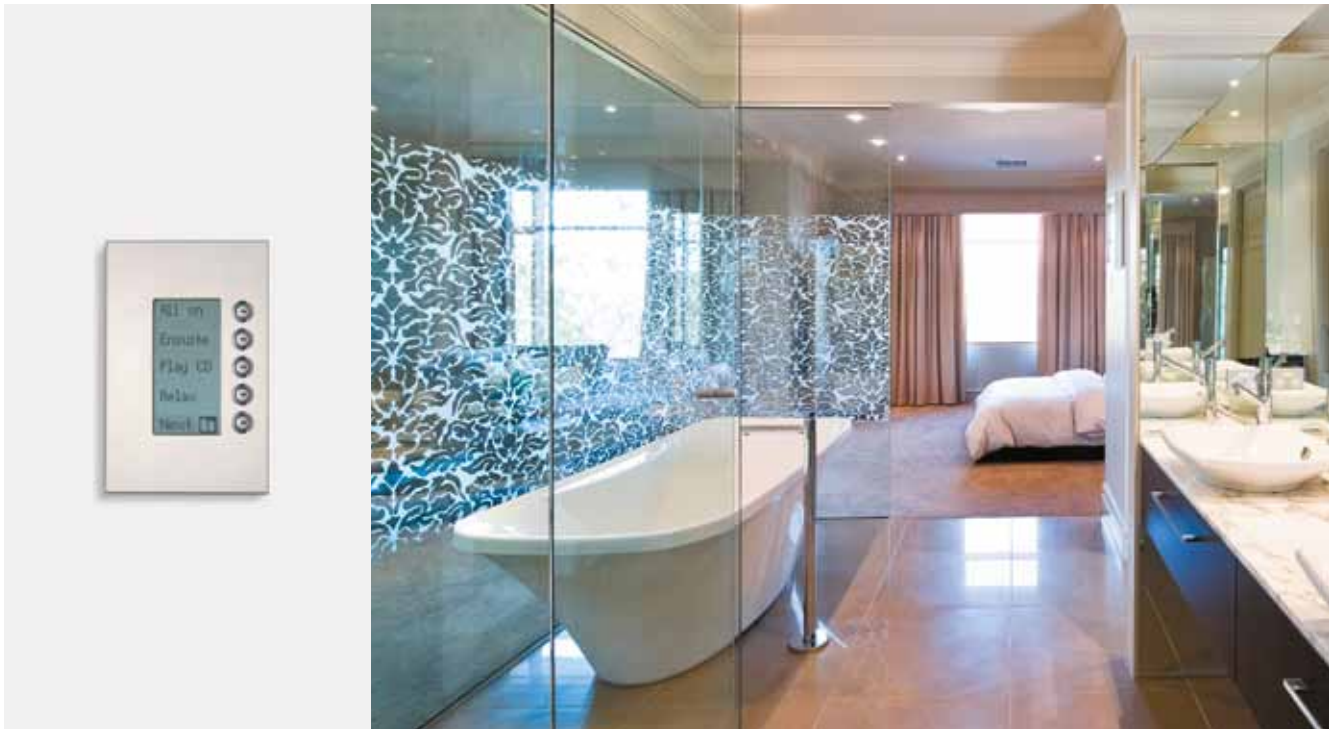

Alternative Products with Metal Finishes

The Metal Plate range is the ideal choice when looking for electrical accessories with metal finishes. Clipsal also offer many other products with metal or decorative metal finishes to complement your project, including various switch and socket ranges, as well as C-Bus, lighting, ceiling sweep fans or specialty products from the Cable Management range. Clipsal's extensive selection of metal finish products ensures you will always find what you are looking for.

2000 Series

The 2000 Series is Australia's biggest selling switch. Manufactured in high gloss, impact resistant material, the 2000 Series incorporates surrounds that simply clip on and are totally interchangeable to create several colour combinations.

The surrounds can be easily removed to enable painting or wall papering right up to the edge. This makes decorating a breeze, as you don't need to fuss over painting too close to the edges. The 2000 Series is available in a full range of colours and metallic surrounds.



2000M-BA plus 2031VA
Wall switch, 1 button, rectangular

Pictured: White with Brushed Aluminium surround.

Classic C2000 Series

The smooth curves and sleek lines of the Classic range reflect the latest interior design trends. Remarkable and affordable, the Classic range features a level of quality and elegance that you would expect from electrical switches and power outlets costing much more.

There are even metal cover finishes and moulded covers, such as the Arctic Silver and Chrome Shadow in the Classic quad power points. Covers and grid plates are easily interchangeable, so you can create combinations to match any interior décor.



C2031VA-WE plus C2031C-BA
Wall switch, 1 button, rectangular

Pictured: Brushed Aluminium



C2015D4-3S
Quad switched socket.

Pictured: Chrome Shadow

Slimline

The Slimline range of switches and sockets are only 4mm thick, or should we say thin. Slimline offers a unique design that still looks at home when used with the Classic range. A selection of metal plate covers and Chrome Shadow finishes are also available.



SC2031VA-3S
Wall switch, 1-gang, rectangular

Pictured: Chrome Shadow

Metal Plate

Alternative Products with Metal Finishes

Eclipse

The Eclipse range of switches and sockets offers one of the thinnest switch plates on the market. With a wafer thin 4mm profile, they are up to 60% thinner than traditional switches. As with Slimline, a range of metal plate covers and Chrome Shadow finishes are also available.



**S2031C-GD plus
SL2031VA-BK**
Wall switch, 1-gang,
rectangular

Pictured: Gold

Saturn Horizon

As recent additions to the stunning Saturn range, Clipsal now offers a textural metallic finish that comes in two fantastic new colours of Horizon Silver and Horizon Black. Horizon features a flat, square edge design that will complement any modern interior.

Horizon Silver and Horizon Black come with a subtle charcoal grey frame and push-buttons that perfectly match the stylish new fascia, and superbly blend in with today's interior design.



4061PBL-HS
Wall switch, 1-gang
push-button
with blue LED,
rectangular

Pictured: Saturn
Horizon Silver

Strato

The Strato 8000 Series provides a minimal low profile design that complements any modern interior. The unique modular look will appeal to those who want an eye-catching, stylish switch to suit today's interior designs.

A wide range of configurations is available in both black and white, providing a seamless electrical solution. Ten interchangeable coloured surrounds are also available and if this doesn't suit your requirements, custom colour options can be ordered from a huge Laminex® selection.

With an extensive choice of easily interchangeable colours you can change your switch colour to suit trends and styles.



**S8083LHA-BK
& S8000HC-BA**
Wall switch, 3-gang, with blue LED

Pictured: Brushed Aluminium

Modena

The Modena 8000 Series is designed with the best form, function and safety features in mind. This classic range comes with larger switches and easy-to-view indicators, tailored with a subtle minimalist finish. The large soft-resistance switch mechanism provides easier operation and practical functionality for all users – including those with limited mobility.

The range of finishes, colours and configurations provides an option to suit any interior décor and perfectly complement a residential or commercial environment. The Modena 8000 Series caters for all applications and specific requirements. From audiovisual and HDMI to push-button dimmer options, Modena 8000 Series is a complete modular switch solution. The Modena 8000 Series surrounds are also compatible with the C-Bus Modena range of wall switches.



**M8025-BK
& M8000HC-CH**
Twin socket outlet, rectangular

Pictured: Chrome

Heritage

The Heritage range brings together old world charm with the benefit of today's technology. These switches and sockets are the perfect solution for those renovating an older style home or to complement the décor of a new federation style dwelling.

Unlike toggle switches of the past, the Clipsal Heritage range offers the safety standards and reliability of modern materials. They're even adaptable to suit outlets for TV antennas, faxes and computers.



1920FR30-BK
Wall switch, 1-gang,
ribbed cover on
porcelain base

Pictured: Chrome
cover on Black base

Prestige

The large 'soft-switch' buttons of the Prestige Range make life easier for those who find a regular switch difficult to use. They're great for when your hands are full or when you're fumbling around for a switch in the middle of the night.

The Prestige range is designed and manufactured in Australia specifically for the visually impaired, people with limited movement or even those who just appreciate the unique, stylish good looks. Streamlined bevelled edges give Prestige switches a generally softer appearance.

Prestige switches are available in a choice of plate sizes, in either moulded colour or metal plate finishes. Covers are easily removed, either to allow painting or papering right up to the edge, or for interchanging with other covers for a brand new décor look.



**P2004/2M-GD plus
P2025/2-WE**
Twin switched
socket, square

Pictured: Gold cover
with White base

Metal Plate

Alternative Products with Metal Finishes

C-Bus Wall Switches

If you're keen on keeping the same style of switches throughout your entire home, Clipsal offer their most popular switch styles incorporated with home automation controls, giving you greater choice than ever before.

Clipsal's striking metal switches also incorporate C-Bus control, and are available in high quality stainless steel or polished brass.



B5032NL
Wall switch,
2-button, 'B' style
flat plate

Pictured: Stainless
Steel



BA5032NL
Wall switch,
2-button, 'A' style
deep curved plate

Pictured: Brass

C-Bus Touch Screens

The C-Touch™ 6.4 Inch Colour Touch Screen is the most advanced of the C-Bus wall mounted LCD touch screens. This stylish touch screen can display pages of graphical items. Buttons, sliders and images can all perform programmable functions, at the touch of your finger. Available in a wide range of metal, Saturn glass or Neo fascias, you can even personalise the screen with your own colour scheme, photographs or screen savers.

The stainless steel fascia is also available in the C-Touch Spectrum Series and Black and White MKII Series of touch screens.



BS5000CTC2
'B' style flat plate metal fascia colour touch
screen, 6.4 inch colour

Pictured: Stainless Steel

C-Bus Dynamic Labelling Technology (DLT) Wall Switches

One of the biggest problems people find with home control is the difficulty in remembering which buttons do what. Clipsal have solved that problem with user friendly Dynamic Labelling Technology™ (DLT).

An Australian first, Clipsal's DLT is available in the C-Bus Saturn and Neo Wall Switches and allows the buttons to be electronically labelled according to your needs. The units have eight function buttons over two pages, a backlight for easy viewing, and support up to eight languages.



5085DL-J80
Wall switch
5 button, DLT

Pictured: Stainless
Steel

C-Bus Saturn Wall Switches

The C-Bus Saturn range boasts a luxurious face and distinctive illuminated round buttons – and is arguably the most beautiful switch range available. The brushed stainless steel finish is not only stylish but is durable and easy to clean. It is fully programmable and can go beyond simple on/off functions, delivering unlimited dimming, switching and other control functions as part of a C-Bus control system.



5086NL-J80
Wall switch, 6-gang
push-button

Pictured: Stainless
Steel

C-Bus Neo Wall Switches

Neo is a smart C-Bus Wall Switch featuring sleek lines and distinctive styling. It provides an alternative to the standard look of electrical wall switches.

The large rocker covers blend beautifully into the fascia. Neo wall switches are fully programmable offering many control functions as part of a C-Bus Control System.



5052NL-GB
Wall switch 2 button

Pictured: Battleship
Grey/Brushed
Aluminium

C-Bus Reflection Wall Switches

Reflection offers a sleek, contemporary design that is constructed from smooth stainless steel - featuring a flat rectangular switch plate without unsightly screws. The metal-look buttons on the C-Bus Reflection Wall Switches can also be removed for engraving if needed. The switches also feature an inbuilt 'cool blue' LED status indicator.



R5061NL
Wall switch 1 button

Pictured: Stainless
Steel

Metal Plate

Alternative Products with Metal Finishes

Downlights

Clipsal's extensive range of downlights come in many varieties to satisfy any style and budget. They're available with standard dichroic lamps, the latest IRC technology, energy saving CFLs and LEDs, so there's sure to be a downlight to suit your needs.



L935W/12WH
Led downlight, 35
degree gimbal

Pictured: White

Exterior Lights

Clipsal offers a range of exterior lighting that is sure to meet most of your outdoor lighting requirements. With a focus towards energy efficiency, Clipsal's Exterior Lighting range constantly evolves with the changing market trends and requirements.



CGB772SS
IP65 light

Pictured: Stainless
Steel

Stair/Wall Lights

Stair/wall lights are ideal for anywhere in the home where low-level lighting is required, such as stairwells and home theatres. They make a great energy efficient lighting option because they utilise LED lamp technology, which consumes very little power and has an extremely long lamp life.

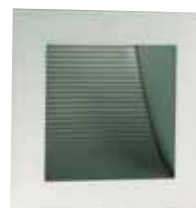

L780WH
Square up down
wall light

Ceiling Sweep Fans

Clipsal's stylish range of super quiet ceiling sweep fans are a great way to circulate air throughout your home. Ceiling sweep fans will keep you cool in summer and circulate warm air in the winter, helping you save on expensive heating and air conditioning bills.

They are also just as effective outdoors in areas such as verandahs and pergolas to keep you cool on hot days and balmy nights. Clipsal ceiling fans are available with remote control and inbuilt lighting options, and a selection of stainless steel and powder coat finishes, so there's sure to be a ceiling fan to suit your home's décor and requirements.



ACES52R5L

5-blade, 1300mm reversible. Satin body and Silver/Black blades, integrated light

Pictured: 5-Blade Ceiling Sweep Fan and Light



ACES48R-SS

Infrared remote control 3-Blade, 1200mm reversible. Satin Chrome body and Stainless Steel blades

Pictured: 3-Blade Ceiling Sweep Fan

Cable Management

Cable Management Floor Access Boxes and Pop-Up Outlets are ideal for any application where safe and convenient access to power, data and audiovisual is required; such as universities, schools, open plan offices, convention/exhibition centres, shopping centres, home theatres and much more.

Cable Management Floor Boxes come in a range of square, rectangular and circular designs in a variety of materials to allow for design coordination, with a selection of outlet configurations to accommodate power, voice/data and audiovisual requirements.

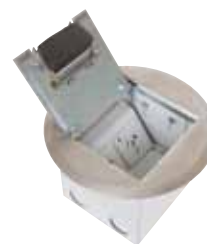

CFFB

CFFB Series Floor Box - round with flush lid

Pictured: Stainless Steel



SBIP2PSS

SOHO pop up desk service outlet

Pictured: Stainless Steel

Metal Plate

Mounting Accessories Cross Reference Guide



	Cat. No.	Switches			Switches	Switches		Electronic Switches
		B31A BB31A	B32A BB32A	B33A BB33A	BSL31VH - BSL36VH BBSL31VH - BBSL36VH BSL31VA, BBSL31VA BSL32VA, BBSL32VA BSL33VA, BBSL33VA BSL34VA, BBSL34VA BSL35VA, BBSL35VA BSL36VA, BBSL36VA	A31VX BA31VX	B31VX BB31VX	B727H, B727EL
Mounting Blocks	449AS	NS2	DM19	NS4	NS12	YES	NS12	UN
	449ASD	NS2	DM19	NS4	NS12	YES	NS12	UN
	449A	NS2	DM19	NS4	NS12	YES	NS12	UN
	238	NS2	DM19	NS4	NS12	YES	NS12	UN
	C2449ASD	NS2	DM19	NS4	NS12	YES	NS12	UN
	900SPBP	NS2	DM19	NS4	NS12	YES	NS12	UN
	900SPMB	NS2	DM19	NS4	NS12	YES	NS12	UN
	25ELSB	NS2	DM19	NS4	NS12	YES	NS12	UN
	900SKMB	NS2	DM19	NS4	NS12	NS12	NS12	UN
Heritage Mounting Blocks	1920MB	NS2	DM19	NS4	NS12	YES	NS12	UN
Wall Clips	154	NS2	DM19	NS4	Y1	YES	YES	UN
	154B25	N13	N13	N13	YES	YES	YES	UN
	154RM	NS2	DM19	NS4	Y1	YES	YES	UN
	154/2	NS2	DM19	NS4	NS12	NS12	NS12	UN
Wall Brackets and Plates	155PRM	NS2	DM19	NS4	Y1X2	YES	YES	UN
	155P	NS2	DM19	NS4	Y1X2	YES	YES	UN
	155	NS2	DM19	NS4	Y1X2	YES	YES	UN
	155NAR	NS2	DM19	NS4	Y1X2	YES	YES	UN
Wall Boxes	157/1P	NS2	DM19	NS4	X5	YES	YES	UN
	157/1PRM	NS2	DM19	NS4	X5	YES	YES	UN
	257	NS2	DM19	NS4	X5	YES	YES	UN
	257D	NS2	DM19	NS4	X5	YES	YES	UN
	257D2	NS2	DM19	NS4	NS12	NS12	NS12	UN
	157	NS2	DM19	NS4	X5	YES	YES	UN
	157/1	NS2	DM19	NS4	X5	YES	YES	UN
	157/1X	NS2	DM19	NS4	X5	YES	YES	UN
	157/2	NS2	DM19	NS4	NS12	NS12	NS12	UN
	160	NS2	DM19	NS4	X5	YES	YES	UN
	164	NS2	DM19	NS4	X5	YES	YES	UN
	164/1	NS2	DM19	NS4	X5	YES	YES	UN
	164/2	NS2	DM19	NS4	NS12	NS12	NS12	UN
	Fire Rated Wall Boxes	157/1F	NS2	DM19	NS4	X5	YES	YES
F157/1		NS2	DM19	NS4	X5	YES	YES	UN
157/2F		NS2	DM19	NS4	NS12	NS12	NS12	UN
Enclosures	224/1	NS2	DM19	NS4	NS12	YES	NS12	UN
	223H	NS2	DM19	NS4	NS12	YES	NS12	UN
	255	NS2	DM19	NS4	NS12	YES	NS12	UN

YOU WILL FIND THE ALPHA NUMERIC KEY TO THESE TABLES ON PAGES 122-123.

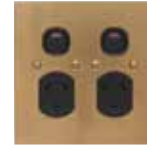

Horizontal Socket Outlets					Vertical Socket Outlets		
	A15A A15SA A15NA A15/15A A15LA A15YA BA15A A15/15A	B15NA, BSL15A BBSL15A, BSL15XA B15LA, BB15NA BB15LA, BSL25A BBSL25A	A25A A25SA A25NA A25X BA25A BA25X	B25SA B25NA BSL25XA BBSL25XA BB25A	A15VA A15VNA A15V15A A15VLA BA15VA BA15VSA BA15VNA	B15VA B15VNA B15V15A B15VLA BB15VA	B15V2A B15V2SA B15V2NA B15V2/15A B15V2LA BB15V2A
Mounting Blocks	Y1	NS12	NS12	NS12	Y1	NS12	NS
	YES	NS12	NS12	NS12	YES	NS12	NS
	YES	NS12	NS12	NS12	YES	NS12	NS
	YES	NS12	NS12	NS12	YES	NS12	NS
	YES	NS12	NS12	NS12	YES	NS12	NS
	YES	NS12	NS12	NS12	YES	NS12	NS
	YES	NS12	NS12	NS12	YES	NS12	NS
	YES	NS12	NS12	NS12	YES	NS12	NS
	NS12	NS12	NS12	NS12	NS12	NS12	NS
Heritage Mounting Blocks	YES	NS12	NS12	NS12	YES	NS12	NS
Wall Clips	Y1	Y1P	Y1	NS12	Y1	Y1P	NS
	YES	YES	YES	YES	YES	YES	N13
	Y1	Y1P	Y1	NS12	Y1	Y1P	NS
	NS12	NS12	NS12	NS12	NS12	NS12	YES
Wall Brackets and Plates	Y1	Y1X2	Y1	Y1X4	Y1	Y1X2	NS
	Y1	Y1X2	Y1	Y1X4	Y1	Y1X2	NS
	Y1	Y1X2	Y1	Y1X4	Y1	Y1X2	NS
	Y1	Y1X2	Y1	Y1X4	Y1	Y1X2	NS
Wall Boxes	YES	X5	YES	X5	YES	X5	NS
	YES	X5	YES	X5	YES	X5	NS
	YES	X5	YES	X5	YES	X5	NS
	YES	X5	YES	X5	YES	X5	NS
	NS12	NS12	NS12	NS12	NS12	NS12	X5
	YES	X5	YES	X4	YES	X5	NS
	YES	X5	YES	X4	YES	X5	NS
	YES	X5	YES	X4	YES	X5	NS
	NS12	NS12	NS12	NS12	NS12	NS12	X5
	YES	X5	YES	X4	YES	X5	NS
	YES	X5	YES	X4	YES	X5	NS
	YES	X5	YES	X4	YES	X5	NS
	NS12	NS12	NS12	NS12	NS12	NS12	X5
Fire Rated Wall Boxes	YES	X5	YES	X4	YES	X5	NS
	YES	X5	YES	X4	YES	X5	NS
	NS12	NS12	NS12	NS12	NS12	NS12	X5
Enclosures	YES	NS12	NS12	NS12	AS	NS12	NS
	Y1	NS12	NS12	NS12	AS	NS12	NS
	YES	NS12	NS12	NS12	AS	NS12	NS

Please Note: Junction boxes are not suitable for Metal Plate range.

YOU WILL FIND THE ALPHA NUMERIC KEY TO THESE TABLES ON PAGES 122-123.

Metal Plate

Alpha Numeric Key for Mounting Accessories

Code	Description
A	Not suitable; access card can't be inserted.
AS	Not suitable; the product can be mounted, however, it will not meet Australian Standards requirements.
CL	Cord line switch (is not mounted to anything).
IP1	Not suitable; as this will affect IP rating of the product.
N	Not suitable; the product can be mounted, however, there is some overhang so covers/surrounds can be easily removed.
N2	Not suitable; product base fouls the inner edge of the accessory, meaning that the mounting centres do not line up.
N3	Not suitable; product base fouls the accessory mounting bosses, meaning that the product can't be mounted flush.
N4	Not suitable; the product can be mounted, however, the required IP rating can no longer be met.
N5	Not suitable; large product base fouls the duct entries of the mounting accessory, meaning that the product can't be flush mounted.
N6	Not suitable; the product can be mounted, however, the 'press to test' and 'press to reset' buttons can't be pushed.
N7	Not suitable; product mounting bosses foul the inner edge of accessory, meaning the product does not fit.
N8	Not suitable; the finished result looks very unprofessional.
N9	Not suitable; the cover/surround does not fit into accessory.
N10	Not suitable; mounting centres line up, however, the product overhangs the accessory.
N11	Not suitable; cored angled recess of C2449ASD can be seen, giving an unprofessional look.
N12	Not suitable; the bosses attaching the mechanism back box to the flush plate protrude below the flush plate edge, meaning that the product can't be flush mounted.
N13	Not suitable; product base is too large to fit into the accessory.
NS1	Not suitable; can be direct mounted to surface (55mm mounting centres).
NS2	Not suitable; can be direct mounted to surface (70mm mounting centres).
NS3	Not suitable; can be direct mounted to surface (98mm mounting centres).
NS4	Not suitable; can be direct mounted to surface (123mm mounting centres).
NS5	Not suitable; can be direct mounted to surface (40mm mounting centres).
NS6	Not suitable; can be direct mounted to surface (60mm mounting centres).
NS7	Not suitable; can be direct mounted to surface (87mm mounting centres).
NS8	Not suitable; can be direct mounted to surface (78mm mounting centres).
NS9	Not suitable; can be direct mounted to surface (136mm mounting centres).
NS11	Not suitable; can be direct mounted to surface (50mm mounting centres).
NS12	Not suitable; can be direct mounted to surface (84mm mounting centres).
NS13	Not suitable; can be direct mounted to surface (75mm mounting centres).
NS14	Not suitable; can be direct mounted to surface (145mm mounting centres).
NS15	Not suitable; can be direct mounted to surface (104mm mounting centres).
NS16	Not suitable; can be direct mounted to surface (120mm mounting centres).
NS17	Not suitable; can be direct mounted to surface (230mm x 40mm mounting centres).
NS18	Not suitable; can be direct mounted to surface (153mm mounting centres).
NS20	Not suitable; can be direct mounted to surface (42mm mounting centres).
NS21	Not suitable; can be direct mounted to surface; must provide insulation on the back of product if mounting to a conductive surface (39mm mounting centres).
NS22	Not suitable; can be direct mounted to surface (35mm mounting centres).
NS23	Not suitable; can be direct mounted to surface (70mm x 70mm mounting centres).
NS24	Not suitable; can be direct mounted to surface (52mm mounting centres).
NS25	Not suitable; can be direct mounted to surface (66mm x 57mm mounting centres).
NS26	Not suitable; can be direct mounted to surface; used as a component part for air movement and heating products, however, if direct mounting product care should be taken with cable isolation (32mm x 34mm mounting centres).
NS27	Not suitable; can be direct mounted to surface (48mm mounting centres).
T	Not suitable; the text on the top of the cover can't be seen.
UN	Unique wall box is supplied with the product.
X4	Yes; ensure mounting accessory is set back 12mm from outer wall surface.
X5	Yes; ensure mounting accessory is set back 25mm from outer wall surface.

Code	Description
S	Yes; the screws supplied with the product are not long enough to mount the product to the accessory.
Y1	Yes; allow 10mm depth for mechanism and cable protrusion.
Y1N	Yes; there is some overhang meaning that covers/surrounds can be easily removed. Allow 10mm depth for mechanism and cable protrusion.
Y1P	Yes; allow 10mm depth for mechanism and cable protrusion. Plastic side flange must be cut off for product to be mounted.
Y1R	Yes; however the product will require 3mm recess to be provided as it will 'bottom out' on the mounting surface.
Y1X2	Yes; ensure mounting accessory is set back 8mm from outer wall surface. Allow 10mm depth for mechanism and cable protrusion.
Y1X4	Yes; ensure mounting accessory is set back 12mm from outer wall surface. Allow 10mm depth for mechanism and cable protrusion.
Y1Y10	Yes; sealant must be used around the mounting accessory (or around where the accessory is mounted to the wall), sealing the accessory to the wall, in order to retain its IP rating. Allow 10mm depth for mechanism and cable protrusion.
Y1Y10N	Yes; sealant must be used around the mounting accessory (or around where the accessory is mounted to the wall), sealing the accessory to the wall, in order to retain its IP rating. Allow 10mm depth for mechanism and cable protrusion. There is also some product overhang, meaning covers/surrounds can be easily removed.
Y1Y11	Yes; sealant must be used around the mounting accessory (or around where the accessory is mounted to the wall), sealing the accessory to the wall, and the cored area mounting bosses in order to retain its IP rating. Allow 10mm depth for mechanism and cable protrusion.
Y2	Yes; allow 15mm depth for mechanism and cable protrusion.
Y2N	Yes; there is some overhang meaning, covers/surrounds can be easily removed. Allow 15mm depth for mechanism and cable protrusion.
Y2X2	Yes; ensure mounting accessory is set back 8mm from outer wall surface. Allow 15mm depth for mechanism and cable protrusion.
Y3	Yes; allow 20mm depth for mechanism and cable protrusion.
Y3N	Yes; there is some overhang meaning, covers/surrounds can be easily removed. Allow 20mm depth for mechanism and cable protrusion.
Y3X2	Yes; ensure mounting accessory is set back 8mm from outer wall surface. Allow 20mm depth for mechanism and cable protrusion.
Y3Y10	Yes; sealant must be used around the mounting accessory (or around where the accessory is mounted to the wall), sealing the accessory to the wall, in order to retain its IP rating. Allow 20mm depth for mechanism and cable protrusion.
Y4	Yes; allow 25mm depth for mechanism and cable protrusion.
Y4N	Yes; there is some overhang meaning, covers/surrounds can be easily removed. Allow 25mm depth for mechanism and cable protrusion.
Y5	Yes; allow 30mm depth for mechanism and cable protrusion.
Y5R	Yes; allow 40mm depth for mechanism and cable protrusion.
Y5N	Yes; there is some overhang meaning, covers/surrounds can be easily removed. Allow 30mm depth for mechanism and cable protrusion.
Y6	Yes; allow 45mm depth for mechanism and cable protrusion.
Y7	Yes; the conduit plugs or conduit have to be shortened to accommodate the large base of product.
Y8	Yes; use as a 3-gang mount (cut out aperture to suit 3-gang product).
Y9	Yes; use as a 3-gang mount (cut out aperture to suit 3-gang product). Allow 30mm depth for mechanism and cable protrusion.
Y10	Yes; sealant must be used around the mounting accessory (or around where the accessory is mounted to the wall), sealing the accessory to the wall, in order to retain its IP rating.
Y10N	Yes; there is some overhang meaning that covers/surrounds can be easily removed. Sealant must be used around the mounting accessory (or around where the accessory is mounted to the wall), sealing the accessory to the wall, in order to retain its IP rating.
Y11	Yes; product must be fully sealed against the 2449ASD (much pressure must be applied) and the deep surround must be sealed against the wall in order for the product to retain its IP rating.
Y12	Yes; sealant must be used in the area around the mounting screws and the conduit/duct entries in order for the product to retain its IP rating.
Y12N	Yes; there is some overhang meaning that covers/surrounds can be easily removed. Sealant must be used in the area around the mounting screws and the conduit/duct entries in order to retain its IP rating.
YM	Yes; must be mounted on a Heritage Mounting Block.

Metal Plate

Quick Reference Guide

Catalogue No.	Description	Length	Width	Depth	Mounting Centres	Page
A31VA	1 Gang Switch. 250V/10A, 1-way/2-way, stainless.	115mm	70mm	30mm	84mm apart	45
A15/15A	Single Switched Socket Outlet, 250V, 15A, stainless.	115mm	70mm	30mm	84mm apart	71
A15/15M	Single Switched Socket Outlet Mechanism, 250V, 15A.	96mm	70mm		84mm apart	71
A15/15NA	Single Switched Socket Outlet, 250V, 15A, neon.	115mm	70mm	30mm	84mm apart	71
A15A	Single Switched Socket Outlet, 250V, 10A, stainless.	115mm	70mm	30mm	84mm apart	71
A15LA	Single Switched Socket Outlet, 250V, 10A, round Earth, stainless.	115mm	70mm	30mm	84mm apart	71
A15M	Single Switched Socket Outlet Mechanism, 250V, 10A.	96mm	70mm		84mm apart	71
A15NA	Single Switched Socket Outlet, 250V, 10A, neon, stainless.	115mm	70mm	30mm	84mm apart	71
A15SA	Single Switched Socket Outlet, 250V, 10A, safety shutters, stainless.	115mm	70mm	30mm	84mm apart	71
A15V15A	Single Switched Socket Outlet, 250V, 15A, stainless.	115mm	70mm	30mm	84mm apart*	80
A15VA	Single Switched Socket Outlet, 250V, 10A, stainless.	115mm	70mm	30mm	84mm apart*	80
A15VM	Single Switched Socket Outlet Mechanism, 250V, 10A.	94mm	55mm	36mm	84mm apart	80
A15YA	Single Switched Socket Outlet, 250V, 10A, lockable flap on socket, stainless.	115mm	70mm	45mm	84mm apart	72
A25A	Twin Switched Socket Outlet, 250V, 10A, stainless.	130mm	86mm	28mm	84mm apart	75
A25NA	Twin Switched Socket Outlet, 250V, 10A, safety shutters and neons, stainless.	130mm	86mm	28mm	84mm apart	75
A25SA	Twin Switched Socket Outlet, 250V, 10A, safety shutters, stainless.	130mm	86mm	28mm	84mm apart	75
A25X	Twin Switched Socket Outlet, 250V, 10A, extra switch, stainless.	130mm	86mm	28mm	84mm apart	75
A31VX	Blank Plate, standard size, stainless.	115mm	70mm	30mm	84mm apart	53
A32VA	2 Gang Switch. 250V/10A, 1-way/2-way, stainless.	115mm	70mm	30mm	84mm apart	45
A33VA	3 Gang Switch. 250V/10A, 1-way/2-way, stainless.	115mm	70mm	30mm	84mm apart	45
A34VA	4 Gang Switch. 250V/10A, 1-way/2-way, stainless.	115mm	70mm	30mm	84mm apart	45
B15/15A	Single Switched Socket Outlet, 250V, 15A, stainless.	115mm	70mm	30mm	84mm apart	73
B15/15M	Single Switched Socket Outlet Mechanism, 250V, 15A.	96mm	55mm		64mm apart	73
B15LA	Single Switched Socket Outlet, 250V, 10A, round Earth, stainless.	115mm	70mm	30mm	84mm apart	73
B15LM	Single Switched Socket Outlet Mechanism, 250V, 10A, round Earth pin.	96mm	55mm		64mm apart	73
B15M	Single Switched Socket Outlet Mechanism, 250V, 10A.	96mm	55mm		64mm apart	73
B15NA	Single Switched Socket Outlet, 250V, 10A, safety shutter and neon, stainless.	115mm	70mm	30mm	84mm apart	73
B15V15A	Single Switched Socket Outlet, 250V, 15A, stainless.	115mm	70mm	35mm	84mm apart*	81

Catalogue No.	Description	Length	Width	Depth	Mounting Centres	Page
B15V2/15A	Twin Switched Socket Outlet, 250V, 15A, stainless.	115mm	115mm	35mm	84mm apart	82
B15V2A	Twin Switched Socket Outlet, 250V, 10A, stainless.	115mm	115mm	35mm	84mm apart	82
B15V2NA	Twin Switched Socket Outlet, 250V, 10A, safety shutters and neons, stainless.	115mm	115mm	35mm	84mm apart	82
B15V2SA	Twin Switched Socket Outlet, 250V, 10A, safety shutters, stainless.	115mm	115mm	35mm	84mm apart	82
B15VA	Single Switched Socket Outlet, 250V, 10A, stainless.	115mm	70mm	35mm	84mm apart*	81
B15VLA	Single Switched Socket Outlet, 250V, 10A, round Earth pin, stainless.	115mm	70mm	35mm	84mm apart*	81
B15VM	Single Switched Socket Outlet Mechanism, 250V, 10A.				84mm apart*	81
B15VNA	Single Switched Socket Outlet, 250V, 10A, safety shutter and neon, stainless.	115mm	70mm	35mm	84mm apart*	81
B15WBS	Spacer to suit B15 and B30 series.	100mm	61mm	13mm	84mm apart	85
B25NA	Twin Switched Socket Outlet, 250V, 10A, safety shutters and neons, stainless.	130mm	85mm	35mm	84mm apart	77
B25SA	Twin Switched Socket Outlet, 250V, 10A, safety shutters, stainless.	130mm	85mm	35mm	84mm apart	77
B25WBS	Spacer to suit B25 series and BSL25XA.	100mm	73mm	13mm	84mm apart	85
B31A	1-Gang Switch. 250V/10A, 1-way/2-way, architrave, stainless.	90mm	35mm	30mm	70mm apart	51
B32A	3-Gang Switch. 250V/10A, 1-way/2-way, architrave, stainless.	110mm	35mm	30mm	95mm apart	51
B33A	5-Gang Switch. 250V/10A, 1-way/2-way, architrave, stainless.	140mm	35mm	30mm	125mm apart	51
B727EL	Universal Shaver Outlet, 240V-110V, with 30mA RCD protection, stainless.	216mm	146mm	70mm	L180mm x W104mm (fascia)*	79
B727H	Universal Shaver Outlet, 240V-110V, includes 727VHB wall box, stainless.	186mm	95mm	90mm*	L157 x W64mm (fascia)	79
BA15/15A	Single Switched Socket Outlet, 250V, 15A, brass.	115mm	70mm	30mm	84mm apart	72
BA15A	Single Switched Socket Outlet, 250V, 10A, brass.	115mm	70mm	30mm	84mm apart	72
BA15VA	Single Switched Socket Outlet, 250V, 10A, brass.	115mm	70mm	35mm	84mm apart*	80
BA25A	Twin Switched Socket Outlet, 250V, 10A, brass.	130mm	86mm	28mm	84mm apart	76
BA25NA	Twin Switched Socket Outlet, 250V, 10A, safety shutters and neons, brass.	130mm	86mm	28mm	84mm apart	76
BA25SA	Twin Switched Socket Outlet, 250V, 10A, safety shutters, brass.	130mm	86mm	28mm	84mm apart	76
BA25X	Twin Switched Socket Outlet, 250V, 10A, extra switch, brass.	130mm	86mm	28mm	84mm apart	76

Metal Plate

Quick Reference Guide

Catalogue No.	Description	Length	Width	Depth	Mounting Centres	Page
BA31VA	1-Gang Switch. 250V/10A, 1-way/2-way, brass.	115mm	70mm	30mm	84mm apart	45
BA31VX	Blank Plate, standard size, brass.	115mm	70mm	30mm	84mm apart	53
BA32VA	2-Gang Switch. 250V/10A, 1-way/2-way, brass.	115mm	70mm	30mm	84mm apart	45
BA33VA	3-Gang Switch. 250V/10A, 1-way/2-way, brass.	115mm	70mm	30mm	84mm apart	45
BA34VA	4-Gang Switch. 250V/10A, 1-way/2-way, brass.	115mm	70mm	30mm	84mm apart	45
BB15/15A	Single Switched Socket Outlet, 250V, 15A, brass.	115mm	70mm	30mm	84mm apart	74
BB15LA	Single Switched Socket Outlet, 250V, 10A, round Earth, brass.	115mm	70mm	30mm	84mm apart	74
BB15VA	Single Switched Socket Outlet, 250V, 10A, brass.	115mm	70mm	35mm	84mm apart*	81
BB25NA	Twin Switched Socket Outlet, 250V, 10A, safety shutters and neons, brass.	130mm	85mm	35mm	84mm apart	78
BB25SA	Twin Switched Socket Outlet, 250V, 10A, safety shutters, brass.	130mm	85mm	35mm	84mm apart	78
BB31A	2-Gang Switch. 250V/10A, 1-way/2-way, architrave, brass.	90mm	35mm	30mm	70mm apart	51
BB32A	4-Gang Switch. 250V/10A, 1-way/2-way, architrave, brass.	110mm	35mm	30mm	95mm apart	51
BB33A	6-Gang Switch. 250V/10A, 1-way/2-way, architrave, brass.	140mm	35mm	30mm	125mm apart	51
BBSL15A	Single Switched Socket Outlet, 250V, 10A, brass.	130mm	85mm	28mm	84mm apart	74
BBSL15XA	Single Switched Socket Outlet, 250V, 10A, extra switch, brass.	130mm	85mm	28mm	84mm apart	74
BBSL25A	Twin Switched Socket Outlet, 250V, 10A, brass.	130mm	85mm	35mm	84mm apart	78
BBSL25XA	Twin Switched Socket Outlet, 250V, 10A, extra switch, brass.	130mm	85mm	35mm	84mm apart	78
BBSL31VA	1-Gang Switch. With over size fascia, brass.	130mm	85mm	30mm	84mm apart	47
BBSL32VA	2-Gang Switch. 250V/10A, 1-way/2-way, brass.	130mm	85mm	30mm	84mm apart	47
BBSL33VA	3-Gang Switch. 250V/10A, 1 way/2 way, brass.	130mm	85mm	30mm	84mm apart	47
BBSL34VA	4-Gang Switch. 250V/10A, 1-way/2-way, brass.	130mm	85mm	30mm	84mm apart	47
BBSL35VA	5-Gang Switch. 250V/10A, 1-way/2-way, brass.	130mm	85mm	30mm	84mm apart	47
BBSL36VA	6-Gang Switch. 250V/10A, 1-way/2-way, brass.	130mm	85mm	30mm	84mm apart	47
BSL15A	Single Switched Socket Outlet, 250V, 10A, stainless.	130mm	85mm	28mm	84mm apart	73
BSL15XA	Single Switched Socket Outlet with extra switch, 250V, 10A, stainless.	130mm	85mm	28mm	84mm apart	73
BSL25A	Twin Switched Socket Outlet, 250V, 10A, stainless.	130mm	85mm	35mm	84mm apart	77

Catalogue No.	Description	Length	Width	Depth	Mounting Centres	Page
BSL25XA	Twin Switched Socket Outlet, 250V, 10A, extra switch, stainless.	130mm	85mm	35mm	84mm apart	77
BSL31VA	1-Gang Switch. 250V/10A, 1-way/2-way, stainless.	130mm	85mm	30mm	84mm apart	46
BSL31VH	1-Gang Switch. With over size fascia, stainless.	130mm	85mm	30mm	84mm apart	54
BSL32VA	2-Gang Switch. 250V/10A, 1-way/2-way, stainless.	130mm	85mm	30mm	84mm apart	46
BSL32VH	2-Gang Switch. With over size fascia, stainless.	130mm	85mm	30mm	84mm apart	54
BSL33VA	3-Gang Switch. 250V/10A, 1-way/2-way, stainless.	130mm	85mm	30mm	84mm apart	46
BSL33VH	3-Gang Switch. With over size fascia, stainless.	130mm	85mm	30mm	84mm apart	54
BSL34VA	4-Gang Switch. 250V/10A, 1-way/2-way, stainless.	130mm	85mm	30mm	84mm apart	46
BSL34VH	4-Gang Switch. With over size fascia, stainless.	130mm	85mm	30mm	84mm apart	54
BSL35VA	5-Gang Switch. 250V/10A, 1-way/2-way, stainless.	130mm	85mm	30mm	84mm apart	46
BSL35VH	5-Gang Switch. With over size fascia, stainless.	130mm	85mm	30mm	84mm apart	54
BSL36VA	6-Gang Switch. 250V/10A, 1-way/2-way, stainless.	130mm	85mm	30mm	84mm apart	46
BSL36VH	6-Gang Switch. With over size fascia, stainless.	130mm	85mm	30mm	84mm apart	54
BSLS15A	Single Switched Socket Outlet, 250V, 10A, security version.	130mm	85mm	28mm	120 x 75mm	43
BSLS15XA	Single Switched Socket Outlet with extra switch, 250V, 10A, security.	130mm	85mm	28mm	120 x 75mm	43
BSLS25A	Twin Switched Socket Outlet, 250V, 10A, security version.	130mm	85mm	35mm	120 x 75mm	43
BSLS25XA	Twin Switched Socket Outlet with extra switch, 250V, 10A, security.	130mm	85mm	35mm	120 x 75mm	43
BSLS25RC	Twin Switched Socket Outlet with RCD, 250V, 10A, security.	130mm	85mm	35mm	120 x 75mm	43
BSLS31VH	1-Gang Switch. With over size fascia, security version.	130mm	85mm	30mm	120 x 75mm	42
BSLS31VX	Blank Flush Gridplate and oversize fascia, security version.	130mm	85mm	1.6mm	120 x 75mm	41
BSLS31VXR1	Blank Flush oversize fascia with single round aperture, security version.	130mm	85mm	1.6mm	120 x 75mm	41
BSLS31VXR2	Blank Flush oversize fascia with two round apertures, security version.	130mm	85mm	1.6mm	120 x 75mm	41
BSLS32VH	2-Gang Switch. With over size fascia, security version.	130mm	85mm	30mm	120 x 75mm	42
BSLS33VH	3-Gang Switch. With over size fascia, security version.	130mm	85mm	30mm	120 x 75mm	42
BSLS34VH	4-Gang Switch. With over size fascia, security version.	130mm	85mm	30mm	120 x 75mm	42
BSLS35VH	5-Gang Switch. With over size fascia, security version.	130mm	85mm	30mm	120 x 75mm	42
BSLS36VH	6 Gang Switch. With over size fascia, security version	130mm	85mm	30mm	120 x 75mm	42

*Without wall box the depth is 70mm, wall box mounting centres are 152mm apart. There is also a grid frame between the wall box and the front fascia plate.

*Wall box mounting centres are L180mm x 84mm apart, wall box measures L197 x W122 x D58mm. There is also a grid frame between the wall box and the front fascia plate.

*Cover plate mounting centres are 30mm apart.

Schneider Electric (Australia) Pty Ltd

33-37 Port Wakefield Road,
Gepps Cross, South Australia 5094

PO Box 132, Enfield Plaza
South Australia 5085

Contact us: cis@clipsal.com.au

CIS Technical Support Hotline

Australia: 1300 722 247
New Zealand: 0800 888 219
Northern Asia: +852 2484 4157
(Hong Kong)
South Africa: 011 314 5200
Southern Asia: +603 7665 3555 x236 or 242
United Kingdom: +44 870 608 8 608
Technical Support Email: cis_support@clipsal.com.au

National Customer Care Enquiries:
1300 2025 25

National Customer Care Facsimile:
1300 2025 56

International Enquiries
International Sales and Marketing
Email: export@clipsal.com.au

New Zealand
Schneider Electric (NZ) Ltd
Telephone: +64 9 576 3403

You can find this brochure and many others online in PDF format at:
clipsal.com

Follow the links off the home page or access the following page directly:
clipsal.com/brochures

You can find this brochure and many others online in PDF format at: **clipsal.com**
Follow the links off the home page or access the following page directly:
clipsal.com/brochures

clipsal.com

As standards, specifications and designs change from time to time, always ask for confirmation of the information given in this publication.

Information given in this publication was accurate at the time of printing.

© 2012 Schneider Electric. All Rights Reserved.
Trademarks are owned by Schneider Electric Industries SAS or its affiliated companies.

This document has been printed using FSC Mix Certified paper. ISO 14001 environmental management system in use at mill.