

2.1 - A Series 105

Suite overview

Potter Interior Systems new series of partitioning systems incorporates a number of new design elements and is still interchangeable with existing series.

Potters have consulted architects, designers, builders and glazing companies and have designed an aluminium system to suit all design and budget requirements.

A Series 105 provides a central line glazing with numerous configurations and design options offering a complete partition system for plasterboard and glazing.

A Series 105 has the following features:

- Standard profile size of 105mm x 25mm or 105mm x 50mm
- Standard wall size based on 64mm steel stud with one layer of plaster board on each side
- Can accommodate glass thicknesses between 6mm - 12.38mm
- Door thicknesses between 38mm - 50mm can be used.
- Shadowline details optional

Specification

The Masterspec branded section 5211PP POTTER ALUMINIUM INTERNAL PARTITIONS is available for download from the following resources.

www.masterspec.co.nz

www.potters.co.nz

www.eboss.co.nz

www.productspec.co.nz



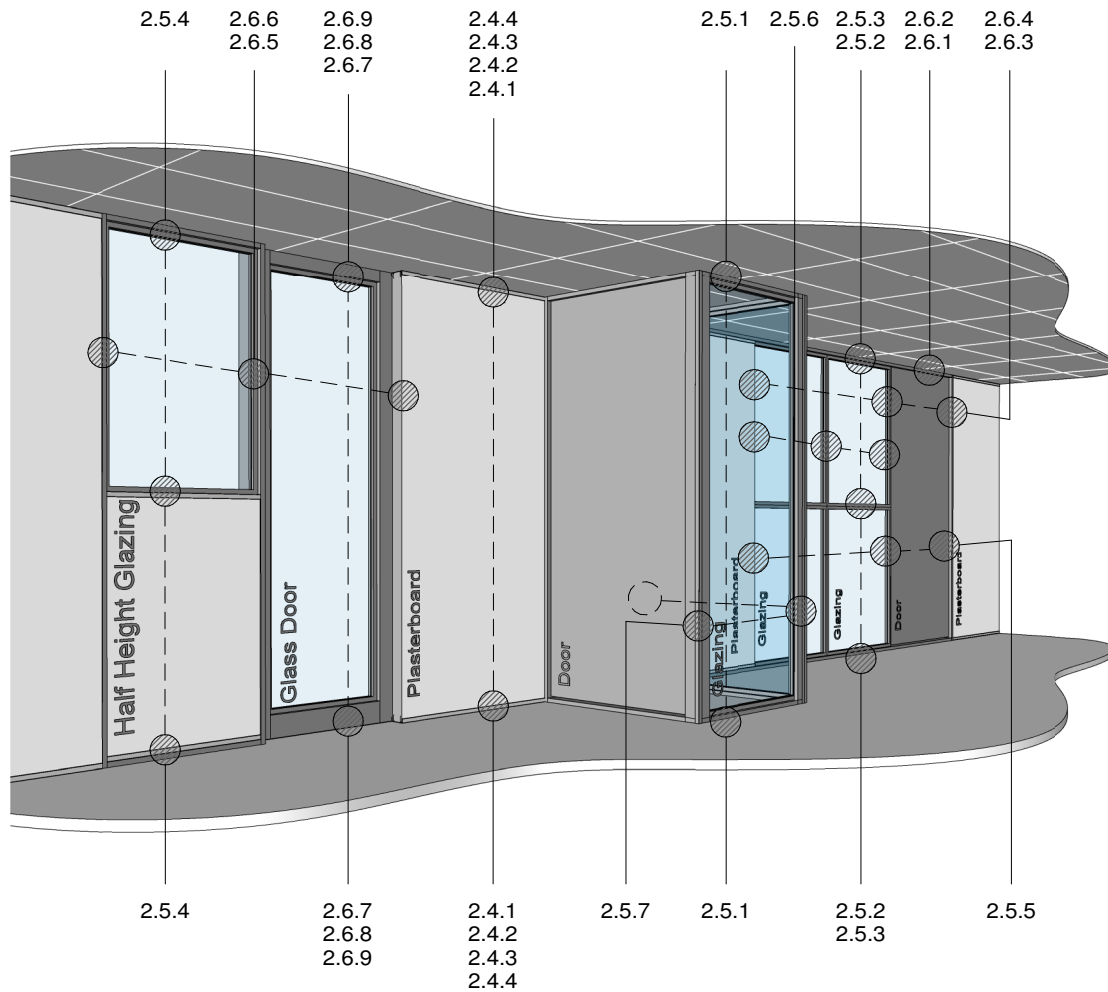

**TIPS FOR ARCHITECTS AND DESIGNERS:
TYPICAL FOR ALL SUITES**

- 6MM - 12.38MM MAXIMUM LAMINATED GLASS SIZE
- 13MM PLASTERBOARD ONLY
- 105MM PROFILES = 64MM STUD
- 132MM PROFILES = 92MM STUD
- FOR SOUND TRANSMISSION CLASS POINTS (STC) REFER TO THE POTTERS WEBSITE WWW.POTTERS.CO.NZ IN THE "PARTITIONING" SECTION

**POTTER ALUMINIUM SYSTEMS
A SERIES 105 DETAIL REFERENCES**

2.2.1
SHEET

SCALE

10/01/2011
ISSUED DATE

0800 POTTER (0800 768 837) WWW.POTTERS.CO.NZ
DETAILS SUBJECT TO CHANGE WITHOUT NOTICE

CSR



PAS009
100MM SKIRTING



PAS009/B
150MM SKIRTING

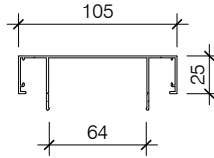

PAS010
105 HEAD/SILL TRACK

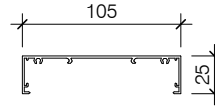

PAS010/A
105 CAPPING HEAD/FRA

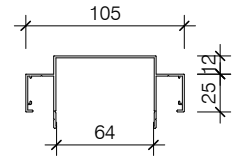

PAS010/C
105 SHADOWLINE HEADTRACK

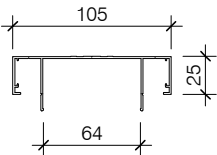

PAS010/R
64mm CAPPING HEAD/FRA

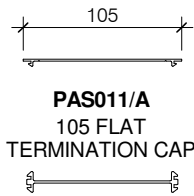

PAS011/A
105 FLAT TERMINATION CAP

PAS011/D
105 JOINING PLATE

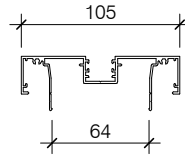

PAS014
105 PLASTERBOARD POCKET CAPPING/FRA

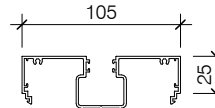

PAS014/A
105 GLAZING ADAPTOR

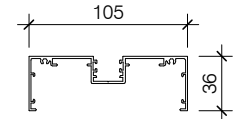

PAS015
105 MEDIUM POCKET CAPPING/FRA

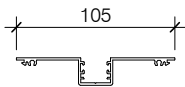

PAS016
105 SNAP IN POCKET



PAS017
105 SNAP IN DOORSTOP UP TO 40MM DOORS



PAS018
105 SNAP IN DOORSTOP UP TO 50MM DOORS

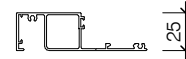

PAS019
105 WIDELINE GLAZING SILL

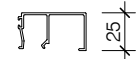

PAS020
105 GLAZING BEAD

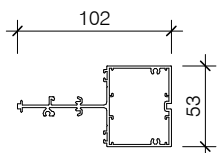

PAS021
105 GLAZING SILL/TRANSOM

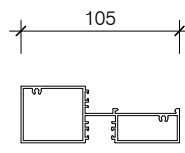

PAS021/A
105 GLAZING SILL/TRANSOM



PAS022
105 TRANSOM BEAD

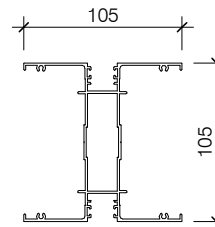

PAS024
105 CORNER POST



PAS023
105 POCKET FLUSH FILLER

POTTER ALUMINIUM SYSTEMS
A SERIES 105 STANDARD SUITE PROFILES

2.3.1
SHEET

1 : 5 @ A4
SCALE

10/01/2011
ISSUED DATE

0800 POTTER (0800 768 837) WWW.POTTERS.CO.NZ
DETAILS SUBJECT TO CHANGE WITHOUT NOTICE

CSR

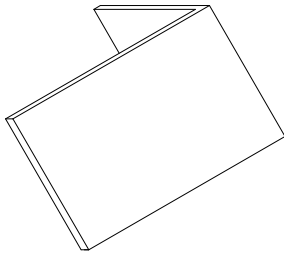

STAKE/1

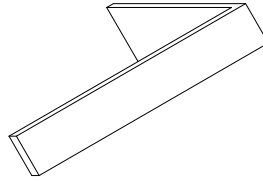

STAKE/3

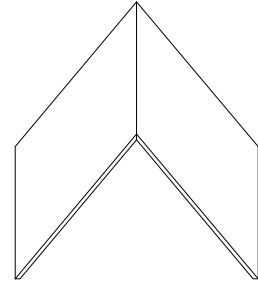

STAKE/8

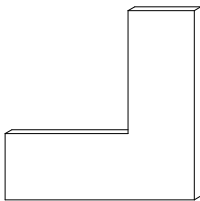

STAKE/6



STAKE/7



PVC SKIRTING INFILL

 UNIVERSAL
 JAMBSEAL

JAMBSEAL INFILL

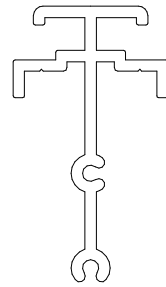
 ACE CAPTIVE
 WEDGE

 GLAZING POST
 SPIGOT

POTTER ALUMINIUM SYSTEMS
A SERIES 105 ACCESSORIES
2.3.2
 SHEET

 1 : 2 @ A4
 SCALE

 10/01/2011
 ISSUED DATE

 0800 POTTER (0800 768 837) WWW.POTTERS.CO.NZ
 DETAILS SUBJECT TO CHANGE WITHOUT NOTICE

CSR

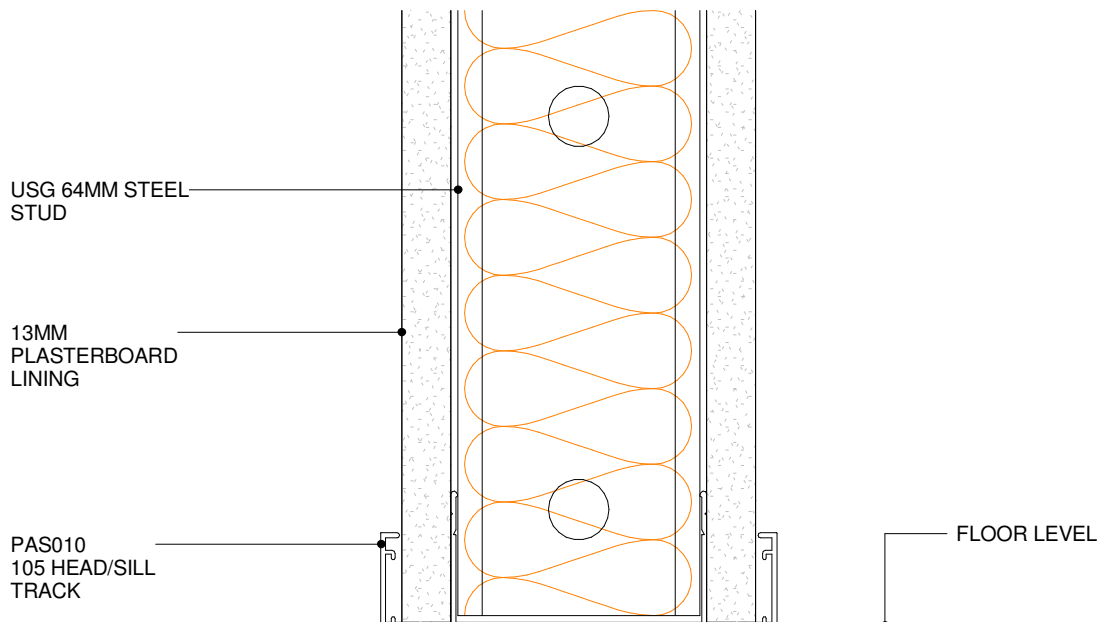
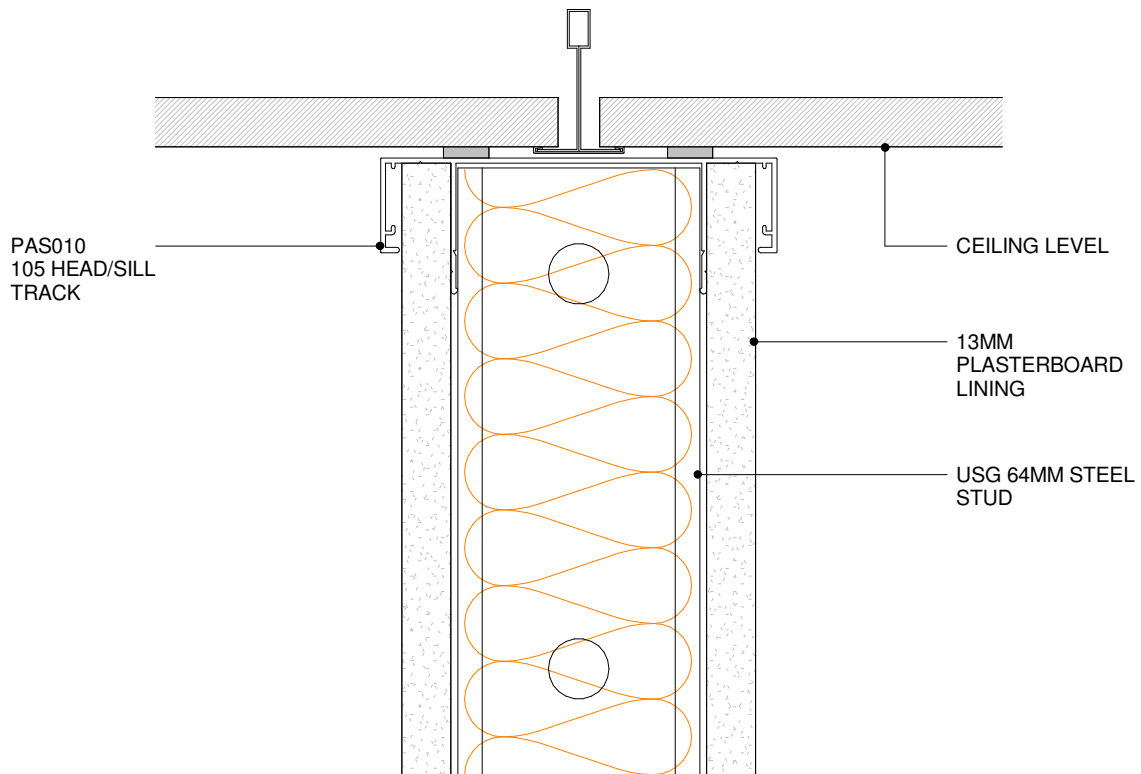

POTTER ALUMINIUM SYSTEMS
A SERIES 105 64MM - STEEL STUD WALL
CROSS SECTION

2.4.1
SHEET

1 : 2 @ A4
SCALE

10/01/2011
ISSUED DATE

0800 POTTER (0800 768 837) WWW.POTTERS.CO.NZ
DETAILS SUBJECT TO CHANGE WITHOUT NOTICE



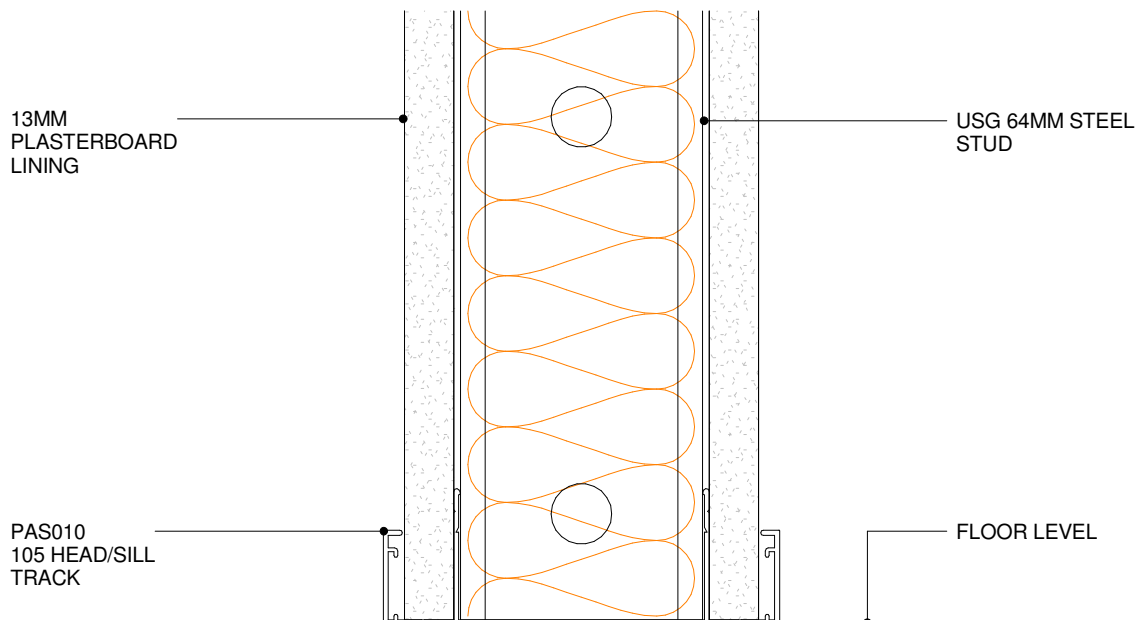
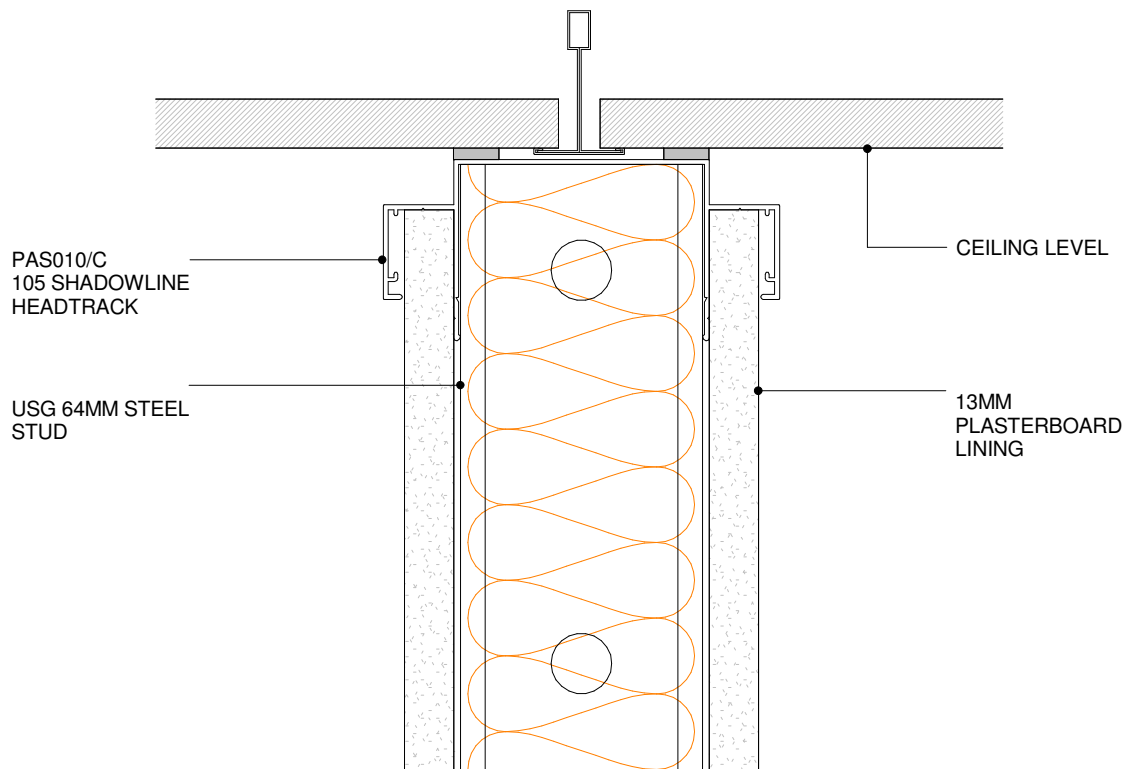

POTTER ALUMINIUM SYSTEMS
A SERIES 105 64MM - STEEL STUD WALL 2
CROSS SECTION

2.4.2
SHEET

1 : 2 @ A4
SCALE

10/01/2011
ISSUED DATE

0800 POTTER (0800 768 837) WWW.POTTERS.CO.NZ
 DETAILS SUBJECT TO CHANGE WITHOUT NOTICE

CSR

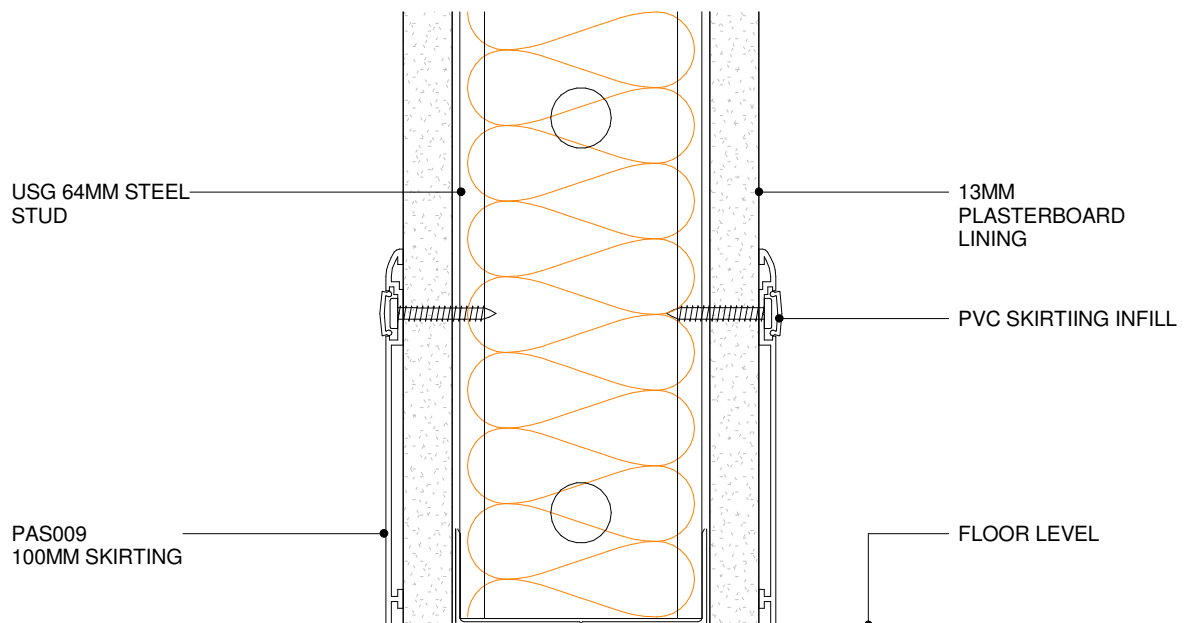
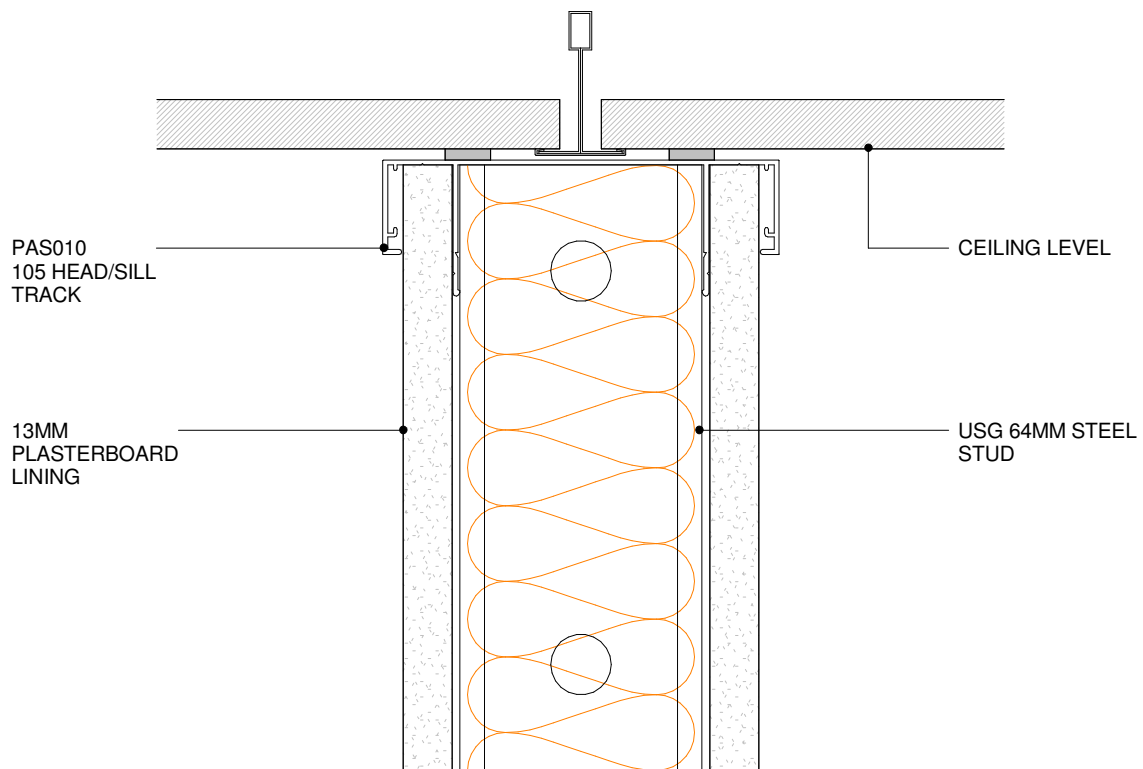

POTTER ALUMINIUM SYSTEMS
A SERIES 105 64MM - FULL HEIGHT STEEL STUD WALL
CROSS SECTION

2.4.3
SHEET

1 : 2 @ A4
SCALE

10/01/2011
ISSUED DATE

0800 POTTER (0800 768 837) WWW.POTTERS.CO.NZ
 DETAILS SUBJECT TO CHANGE WITHOUT NOTICE



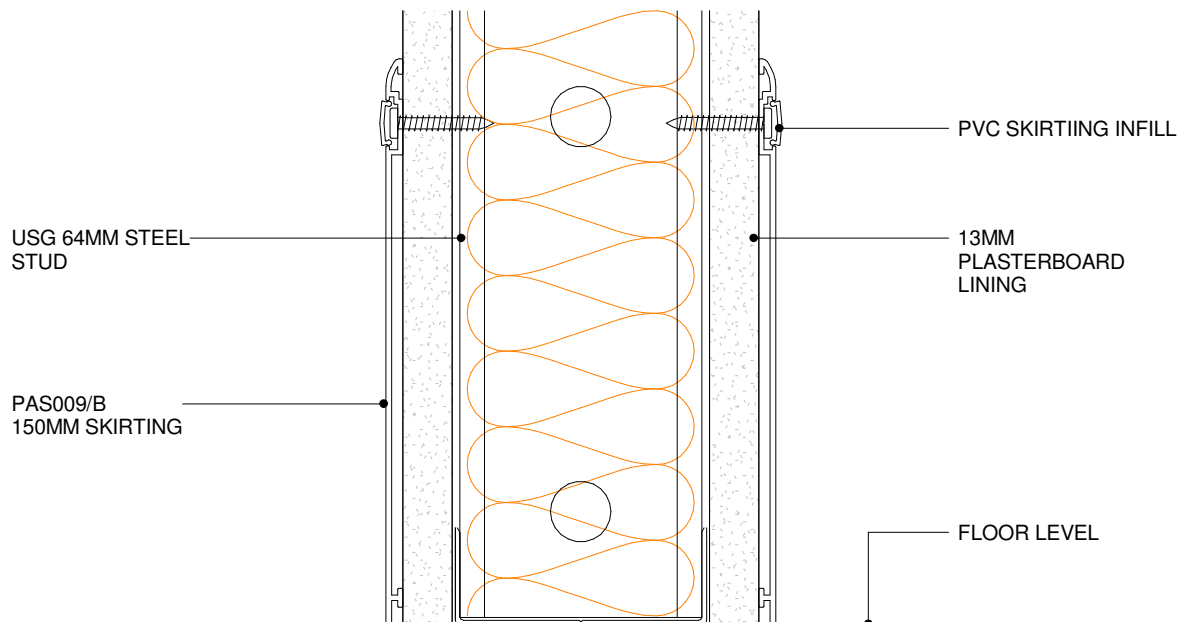
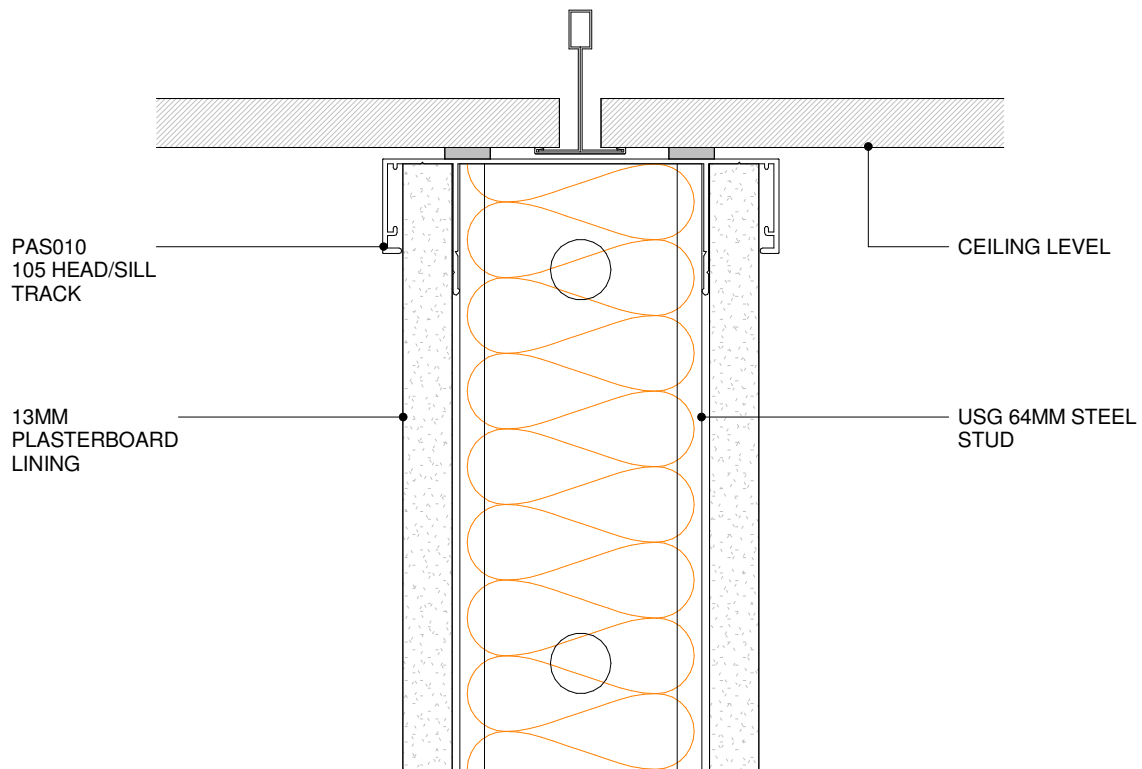

POTTER ALUMINIUM SYSTEMS
A SERIES 105 64MM - FULL HEIGHT STEEL STUD WALL 2
CROSS SECTION

2.4.4
 SHEET

1 : 2 @ A4
 SCALE

10/01/2011
 ISSUED DATE

0800 POTTER (0800 768 837) WWW.POTTERS.CO.NZ
 DETAILS SUBJECT TO CHANGE WITHOUT NOTICE



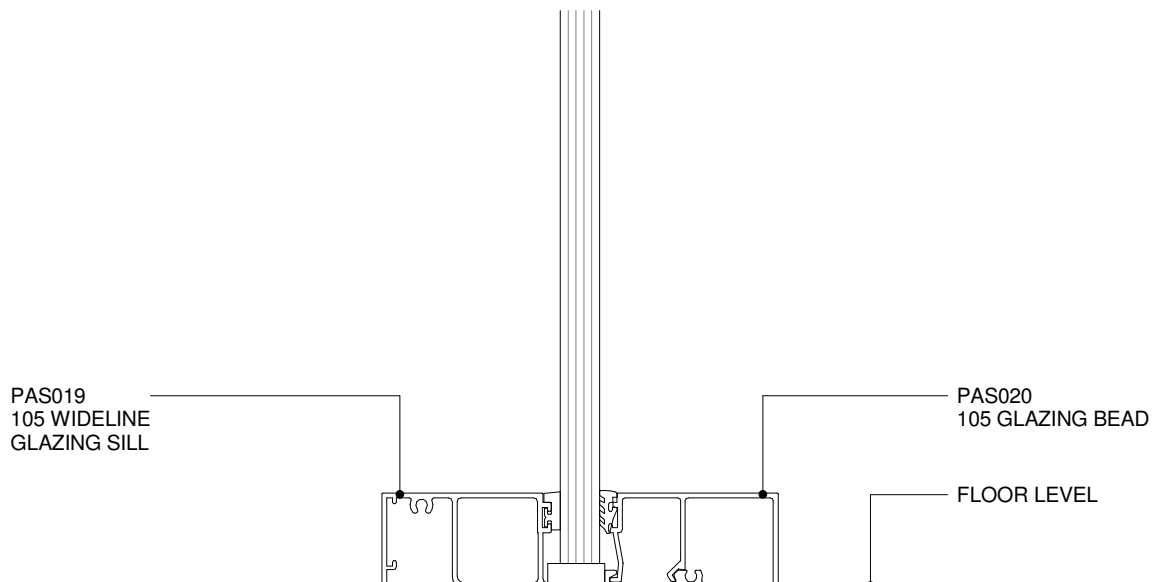
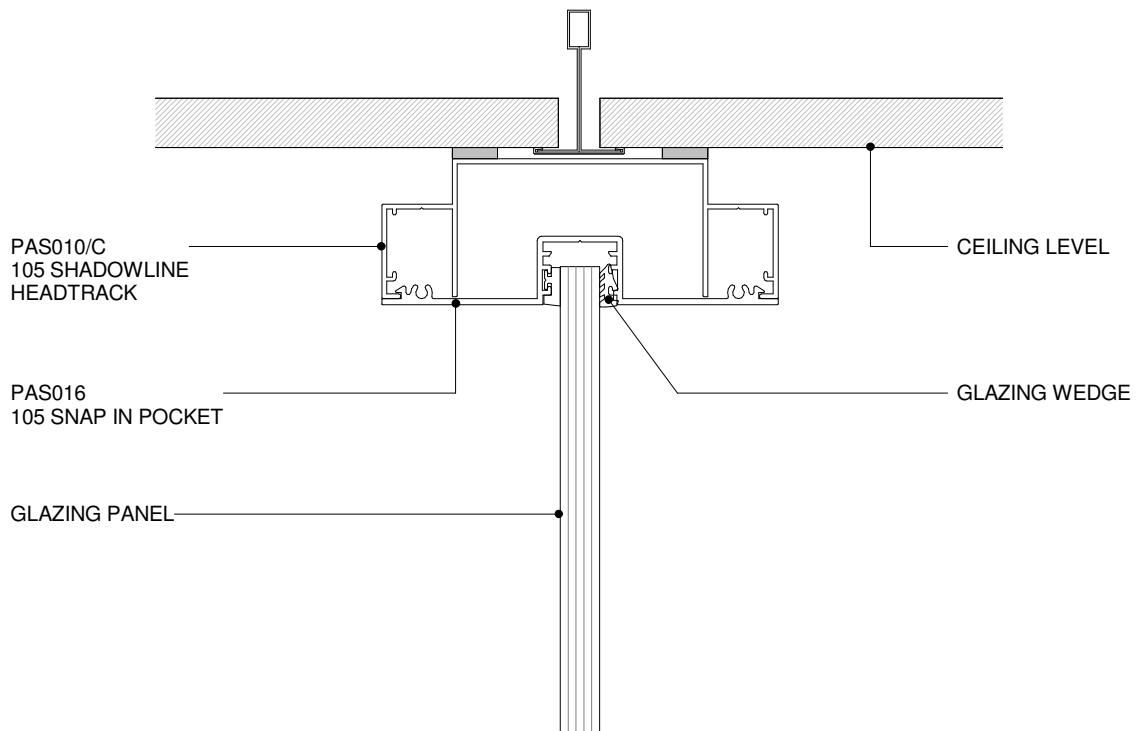

POTTER ALUMINIUM SYSTEMS
A SERIES 105 64MM - FULL HEIGHT GLAZING
CROSS SECTION

2.5.1

SHEET

1 : 2 @ A4
SCALE

10/01/2011
ISSUED DATE

0800 POTTER (0800 768 837) WWW.POTTERS.CO.NZ
DETAILS SUBJECT TO CHANGE WITHOUT NOTICE

CSR

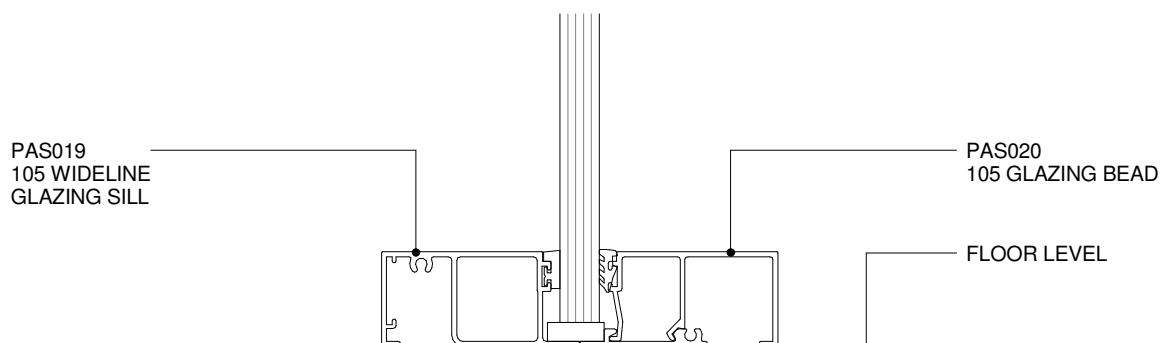
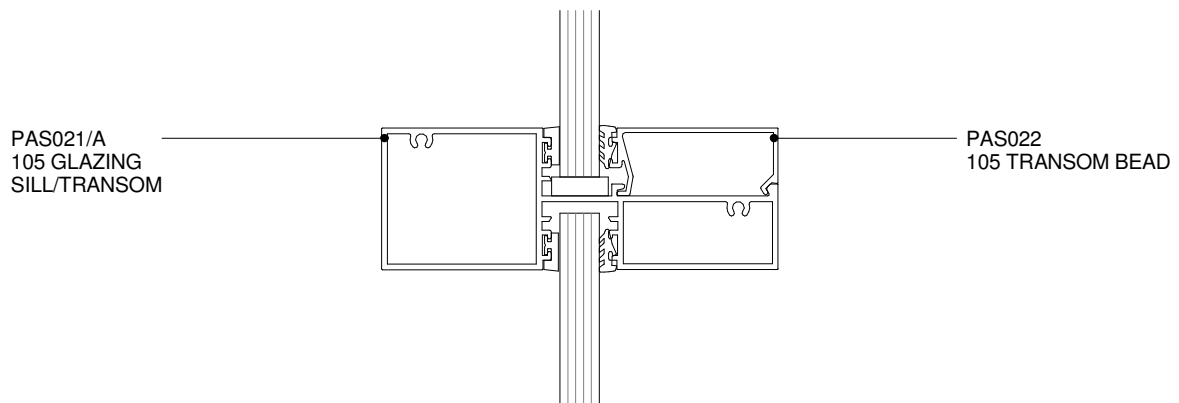
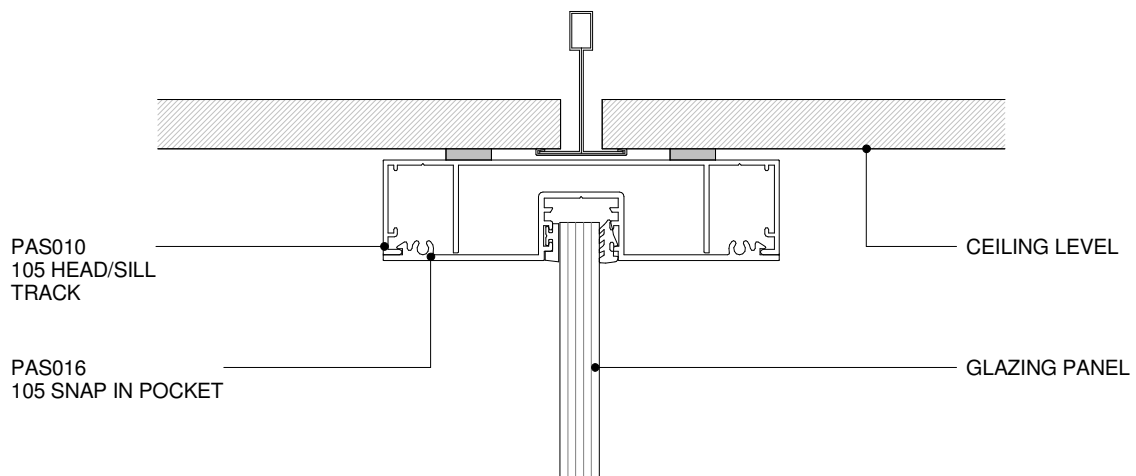

POTTER ALUMINIUM SYSTEMS
A SERIES 105 64MM - TRANSOM IN GLAZED WALL
CROSS SECTION

2.5.2
SHEET

1 : 2 @ A4
SCALE

10/01/2011
ISSUED DATE

0800 POTTER (0800 768 837) WWW.POTTERS.CO.NZ
DETAILS SUBJECT TO CHANGE WITHOUT NOTICE

CSR

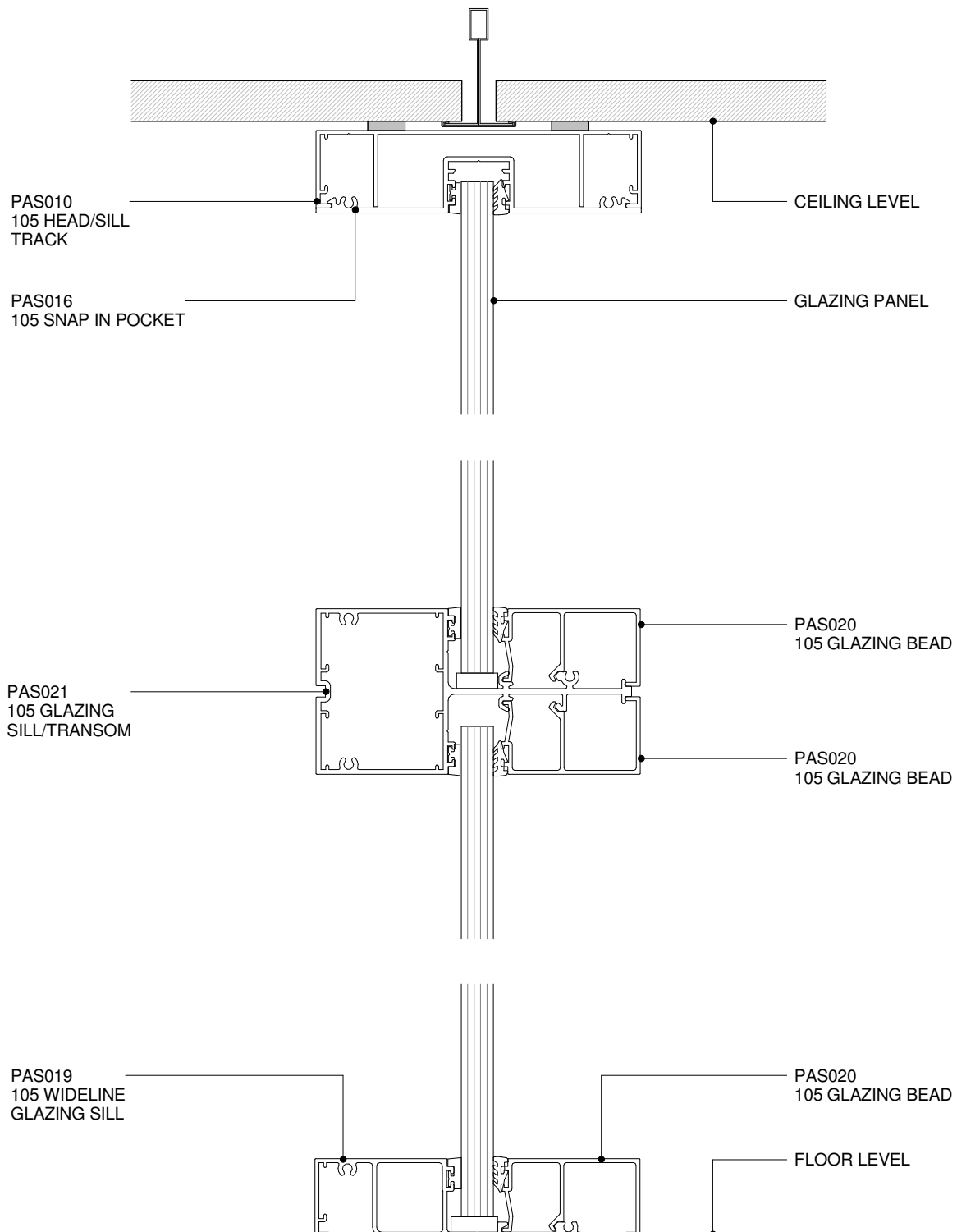

POTTER ALUMINIUM SYSTEMS
A SERIES 105 64MM - OPTIONAL TRANSOM IN GLAZED WALL
CROSS SECTION

2.5.3

SHEET

1 : 2 @ A4
SCALE

10/01/2011
ISSUED DATE

0800 POTTER (0800 768 837) WWW.POTTERS.CO.NZ
DETAILS SUBJECT TO CHANGE WITHOUT NOTICE

CSR

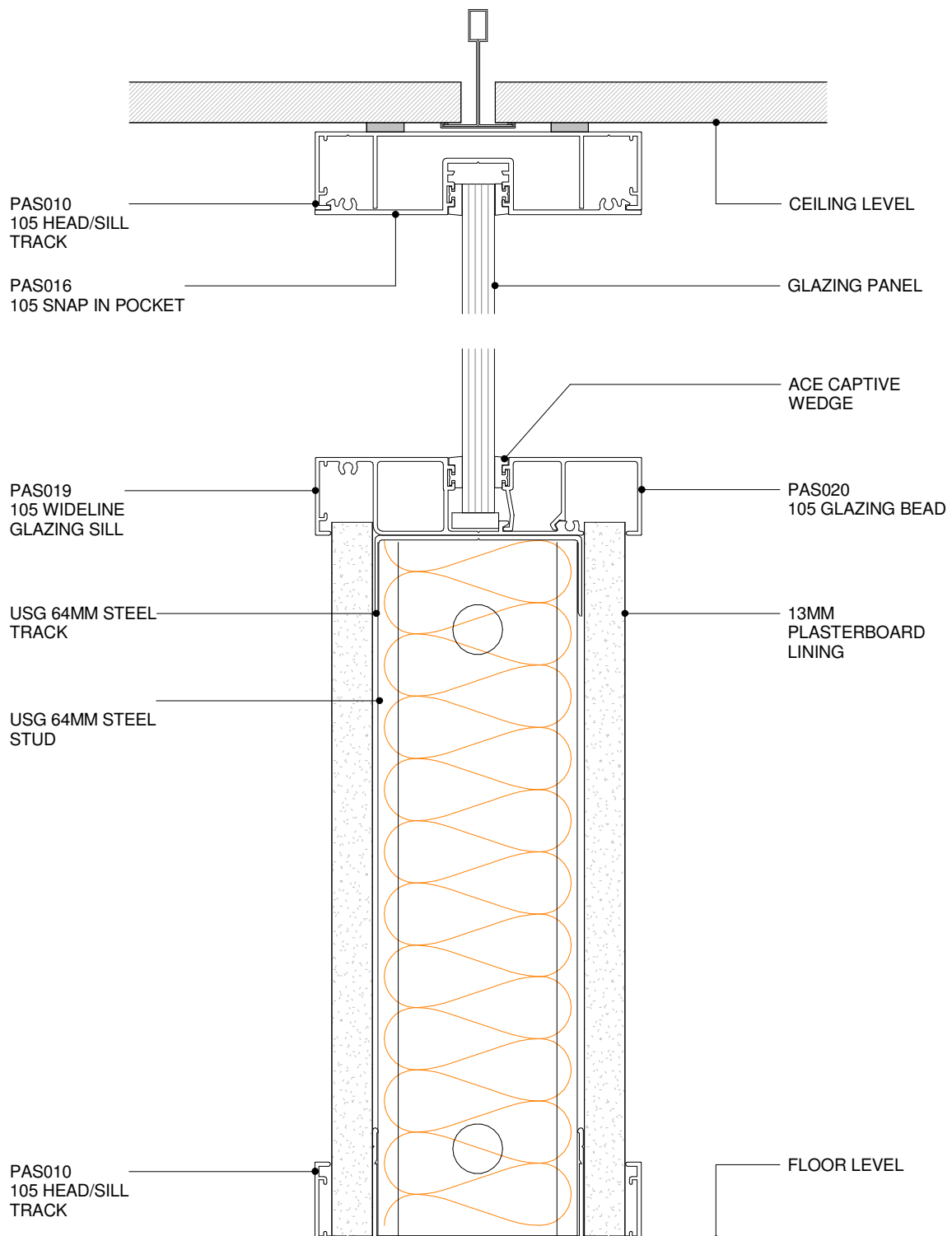

POTTER ALUMINIUM SYSTEMS
A SERIES 105 64MM - HALF HEIGHT GLAZED WALL
CROSS SECTION

2.5.4
SHEET

1 : 2 @ A4
SCALE

10/01/2011
ISSUED DATE

0800 POTTER (0800 768 837) WWW.POTTERS.CO.NZ
DETAILS SUBJECT TO CHANGE WITHOUT NOTICE



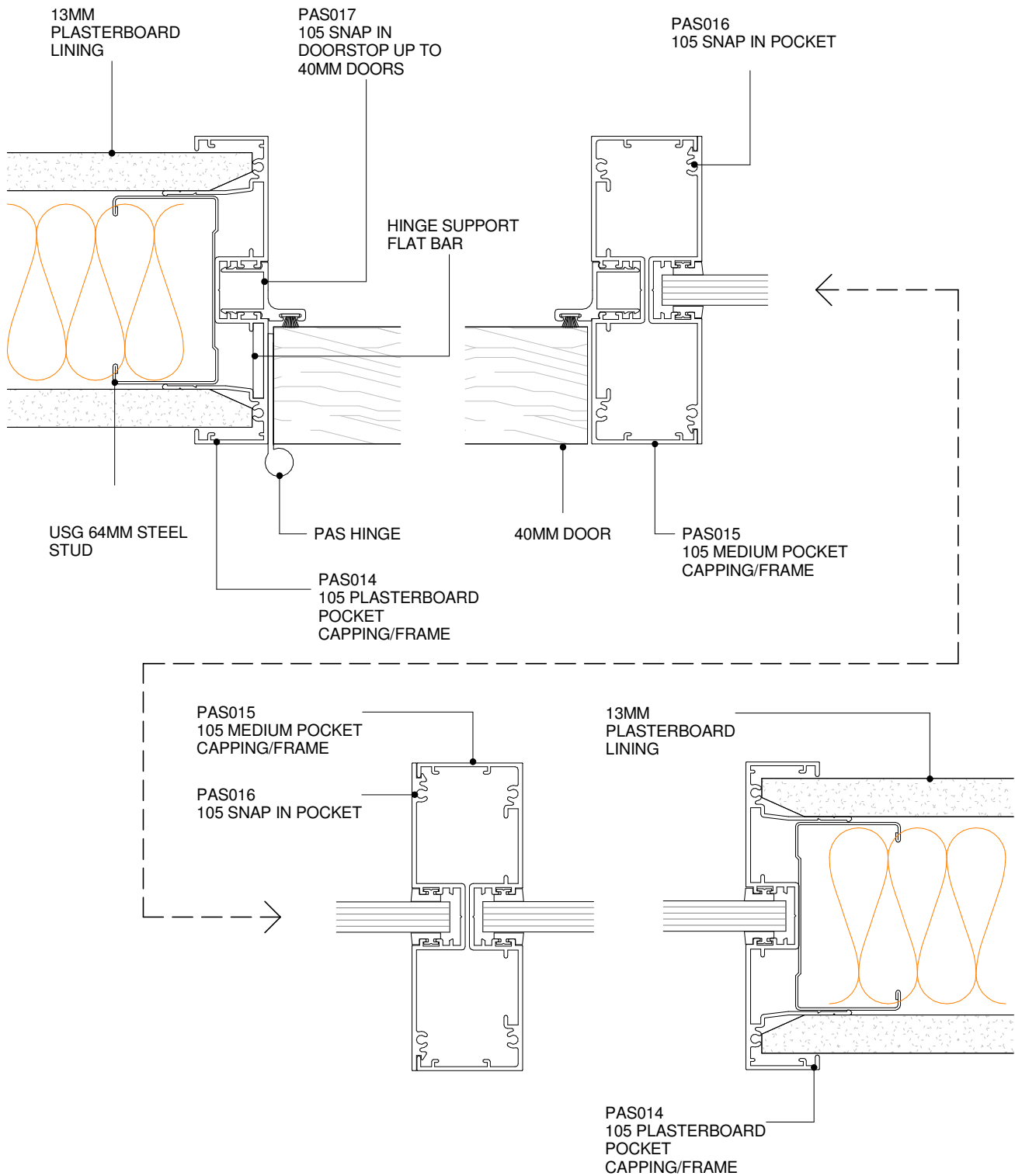

POTTER ALUMINIUM SYSTEMS
A SERIES 105 64MM - DOOR/GLAZING MULLION
PLAN VIEW

2.5.5

SHEET

1 : 2 @ A4
 SCALE

10/01/2011
 ISSUED DATE

0800 POTTER (0800 768 837) WWW.POTTERS.CO.NZ
 DETAILS SUBJECT TO CHANGE WITHOUT NOTICE

CSR

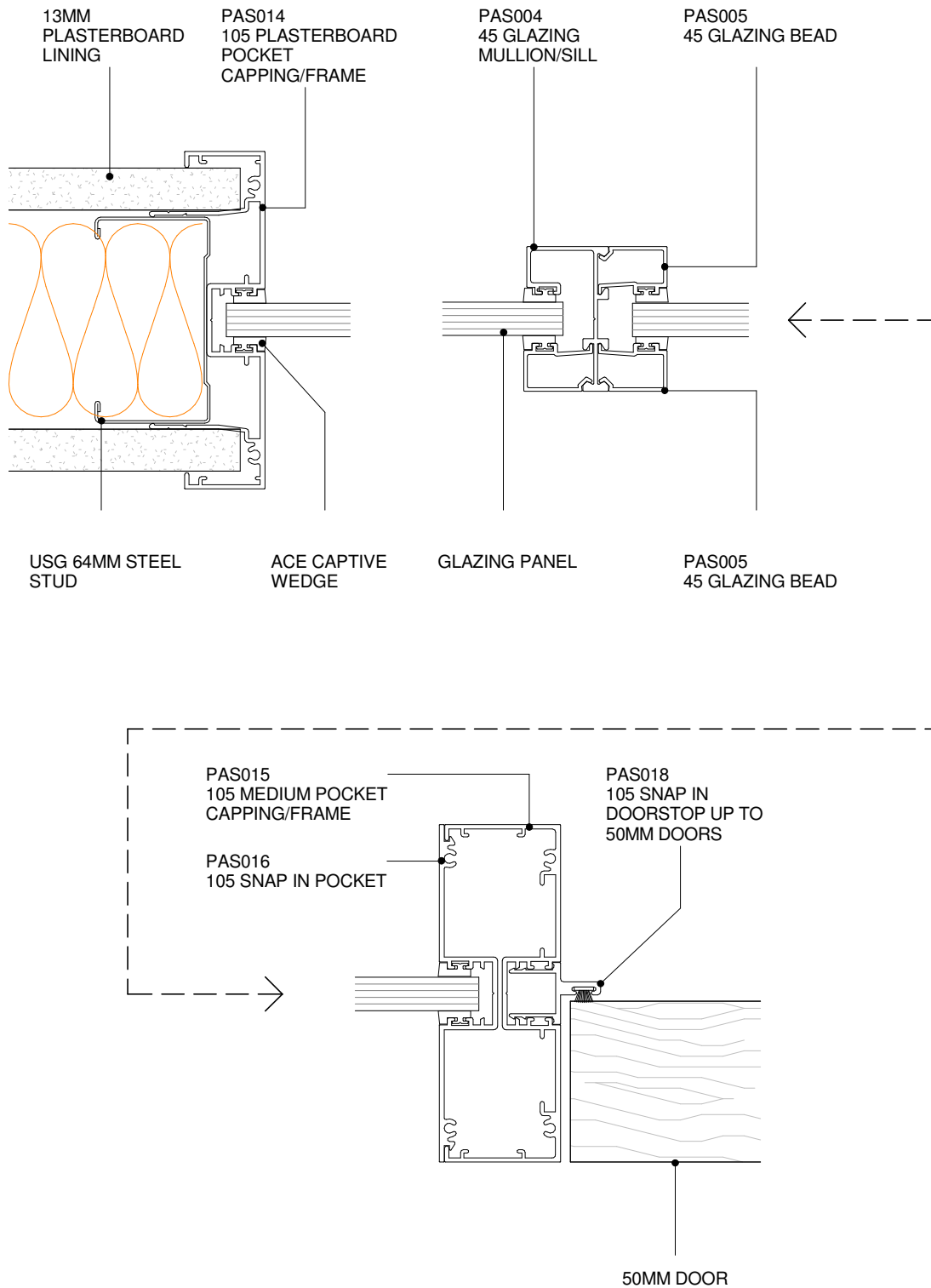

POTTER ALUMINIUM SYSTEMS
A SERIES 105 64MM - GLAZING BAR/BEAD MULLION
PLAN VIEW

2.5.6

SHEET

1 : 2 @ A4
 SCALE

10/01/2011
 ISSUED DATE

0800 POTTER (0800 768 837) WWW.POTTERS.CO.NZ
 DETAILS SUBJECT TO CHANGE WITHOUT NOTICE

CSR

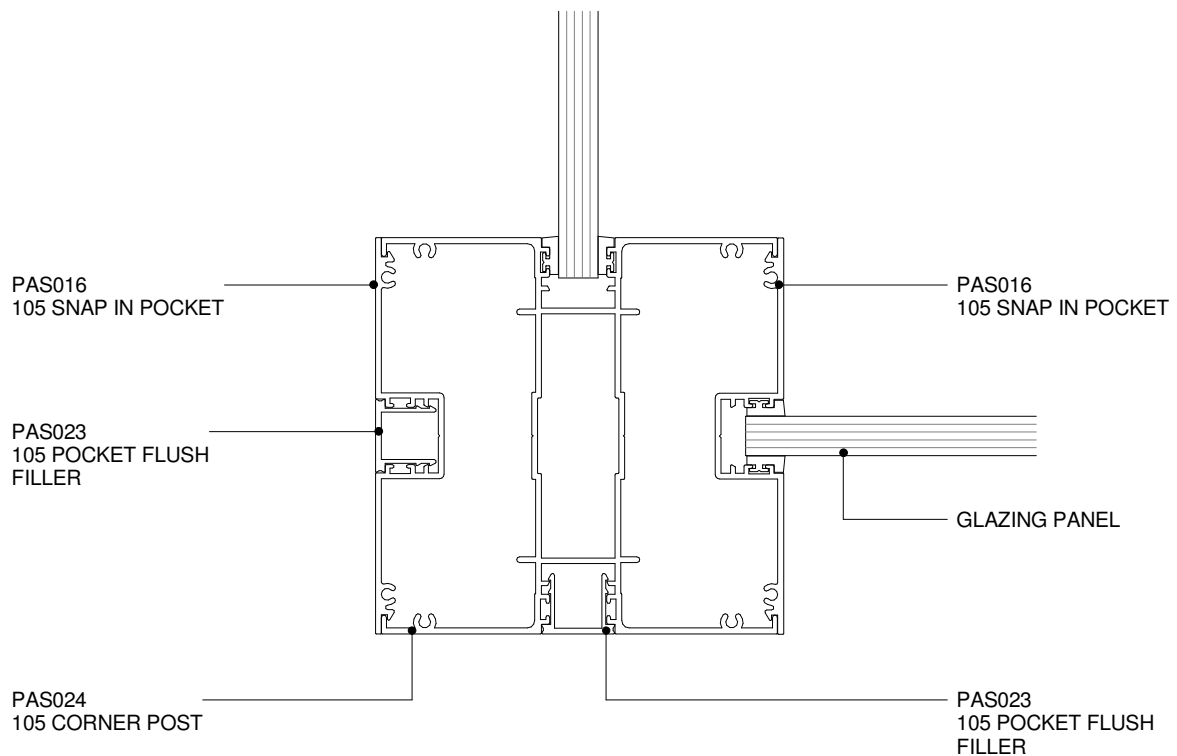
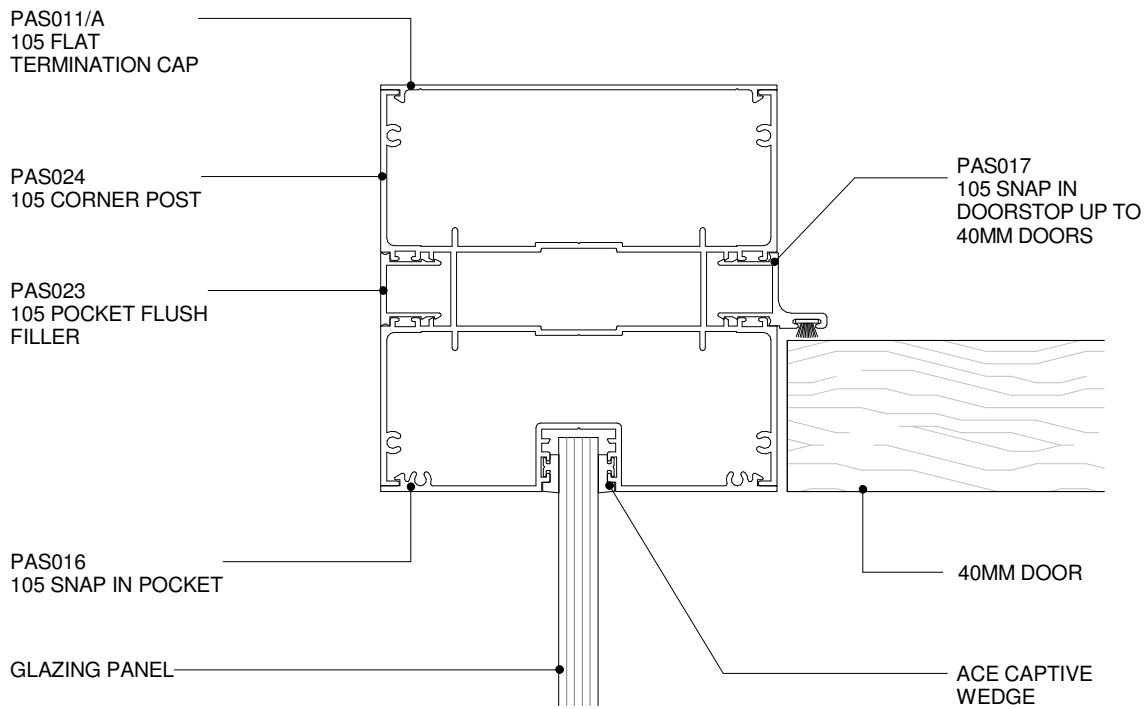

POTTER ALUMINIUM SYSTEMS
A SERIES 105 64MM - LARGE GLAZING POSTS
PLAN VIEW

2.5.7
 SHEET

1 : 2 @ A4
 SCALE

10/01/2011
 ISSUED DATE

0800 POTTER (0800 768 837) WWW.POTTERS.CO.NZ
 DETAILS SUBJECT TO CHANGE WITHOUT NOTICE



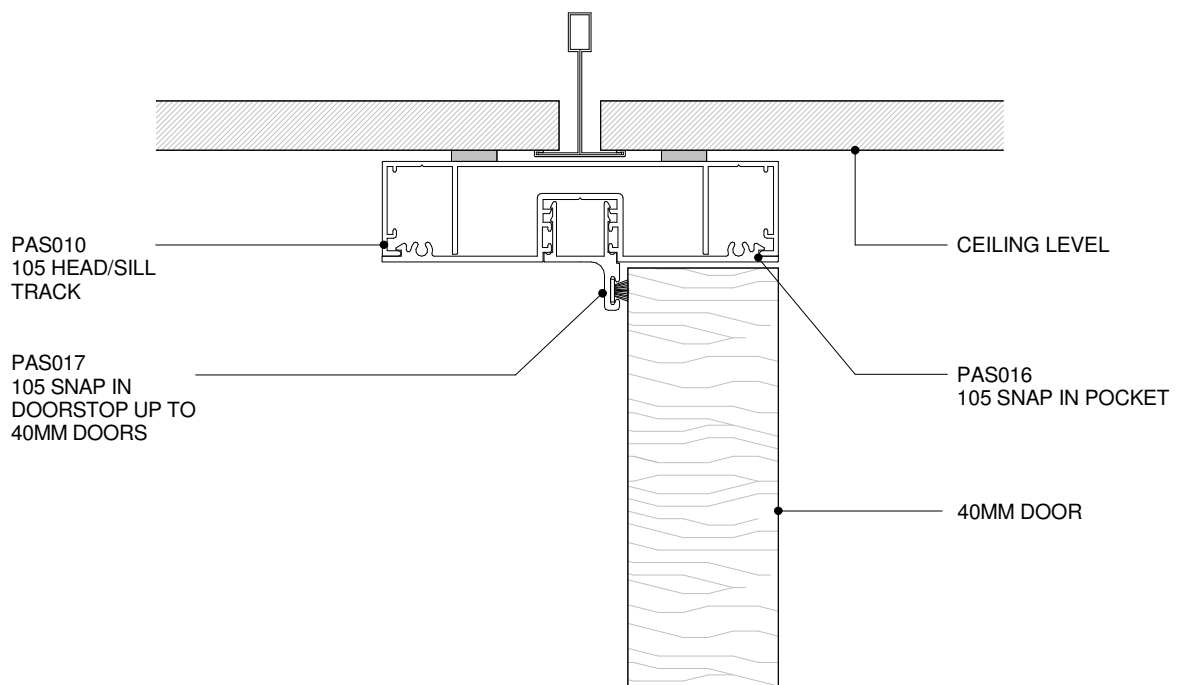
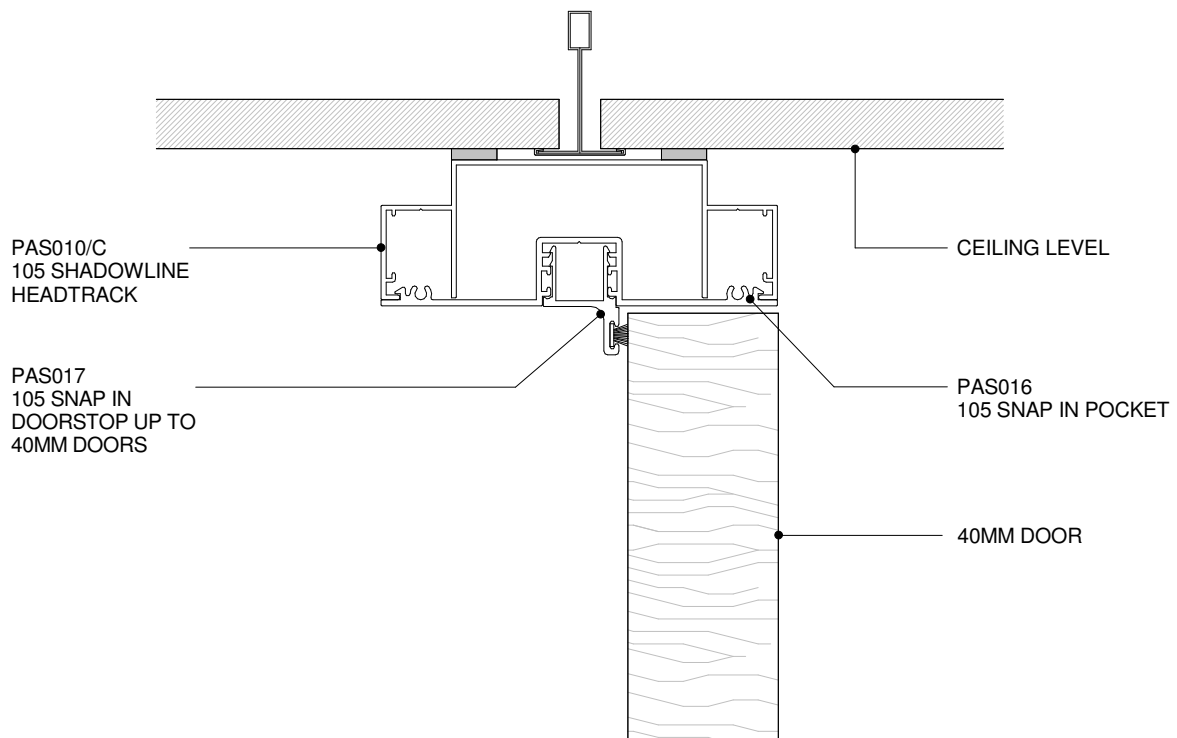

POTTER ALUMINIUM SYSTEMS
A SERIES 105 64MM - 40MM DOOR HEADTRACK DETAILS
CROSS SECTION

2.6.1
SHEET

1 : 2 @ A4
SCALE

10/01/2011
ISSUED DATE

0800 POTTER (0800 768 837) WWW.POTTERS.CO.NZ
 DETAILS SUBJECT TO CHANGE WITHOUT NOTICE



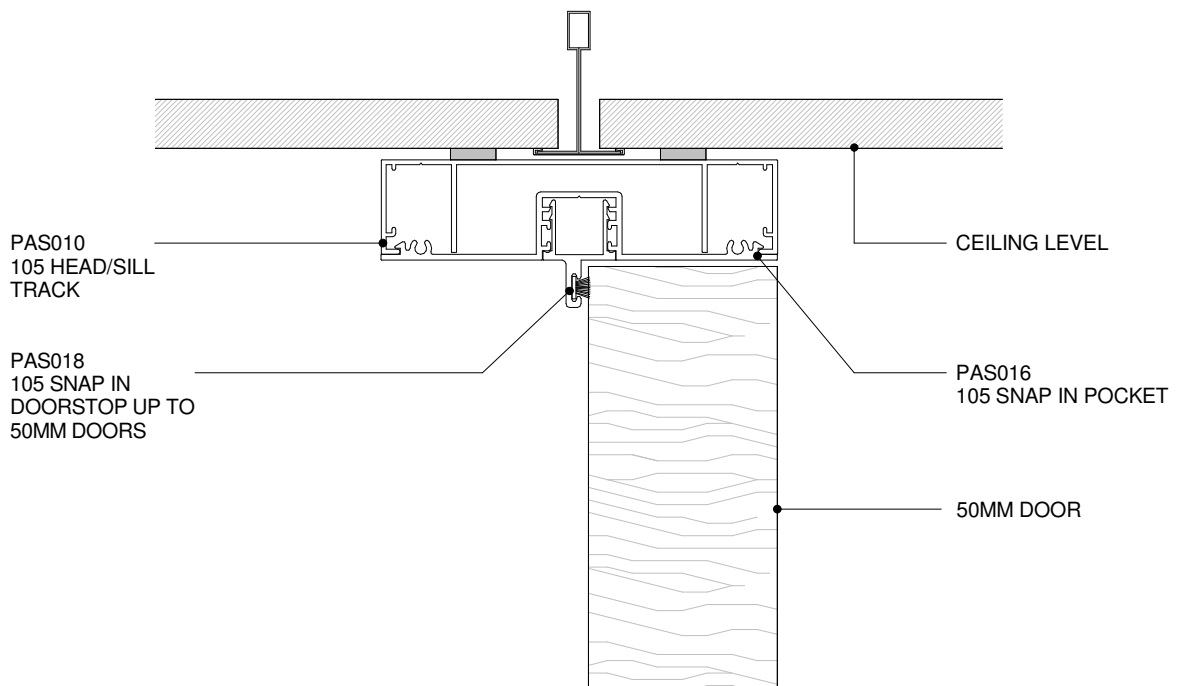
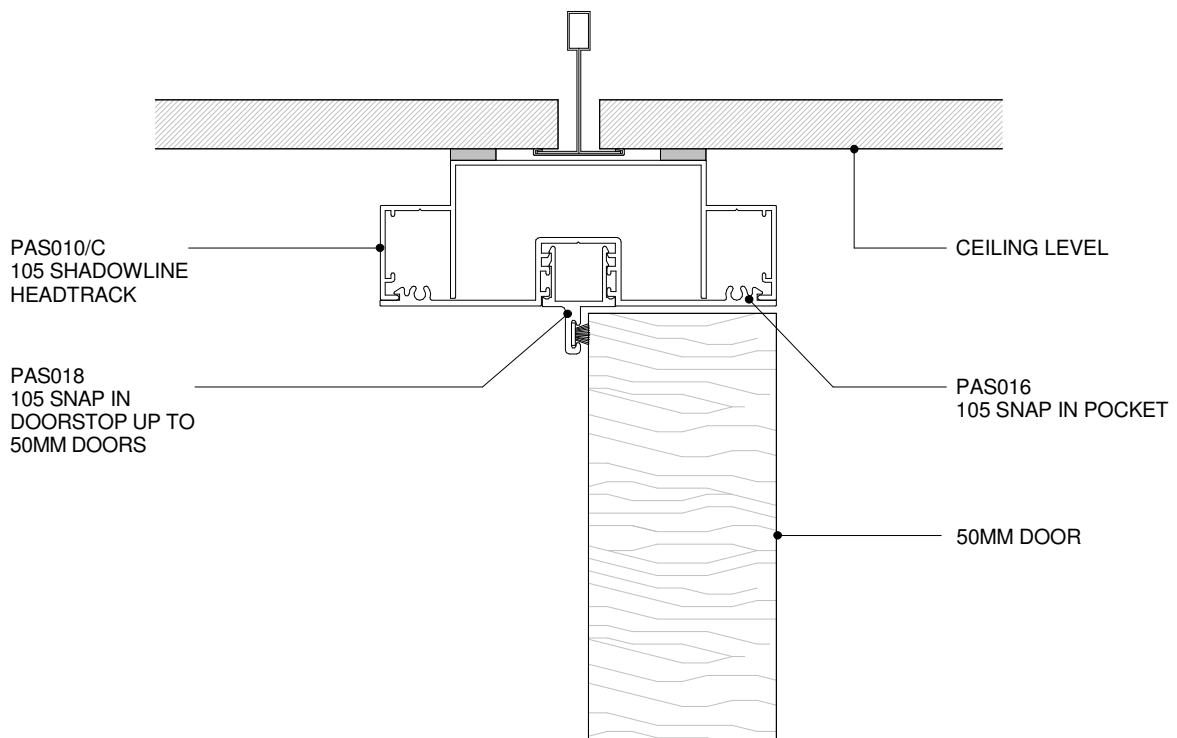

POTTER ALUMINIUM SYSTEMS
A SERIES 105 64MM - 50MM DOOR HEADTRACK DETAILS
CROSS SECTION

2.6.2
 SHEET

1 : 2 @ A4
 SCALE

10/01/2011
 ISSUED DATE

0800 POTTER (0800 768 837) WWW.POTTERS.CO.NZ
 DETAILS SUBJECT TO CHANGE WITHOUT NOTICE



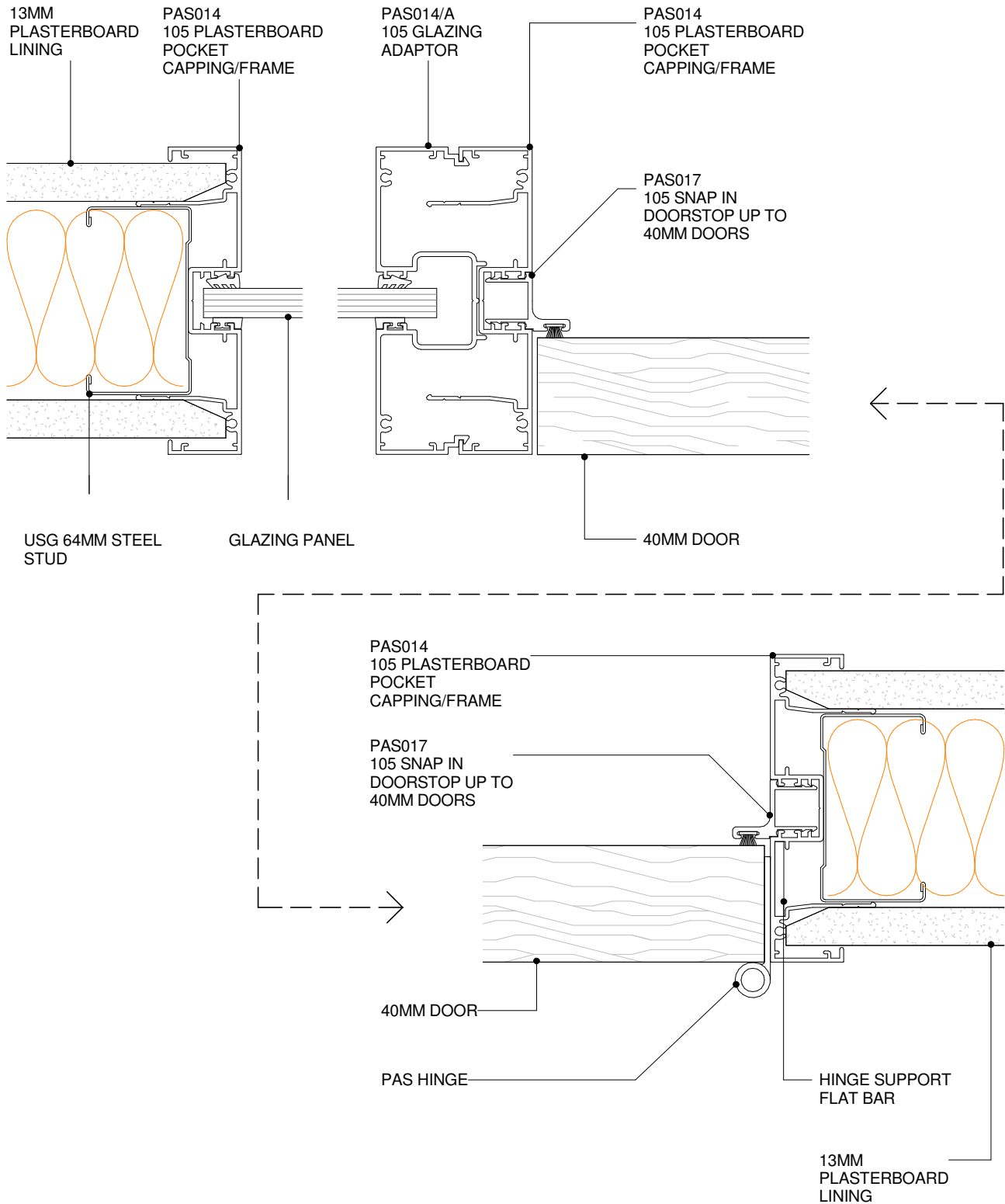

POTTER ALUMINIUM SYSTEMS
A SERIES 105 - 40MM DOOR TO HEADTRACK
PLAN VIEW

2.6.3

SHEET

1 : 2 @ A4
 SCALE

10/01/2011
 ISSUED DATE

0800 POTTER (0800 768 837) WWW.POTTERS.CO.NZ
 DETAILS SUBJECT TO CHANGE WITHOUT NOTICE

CSR

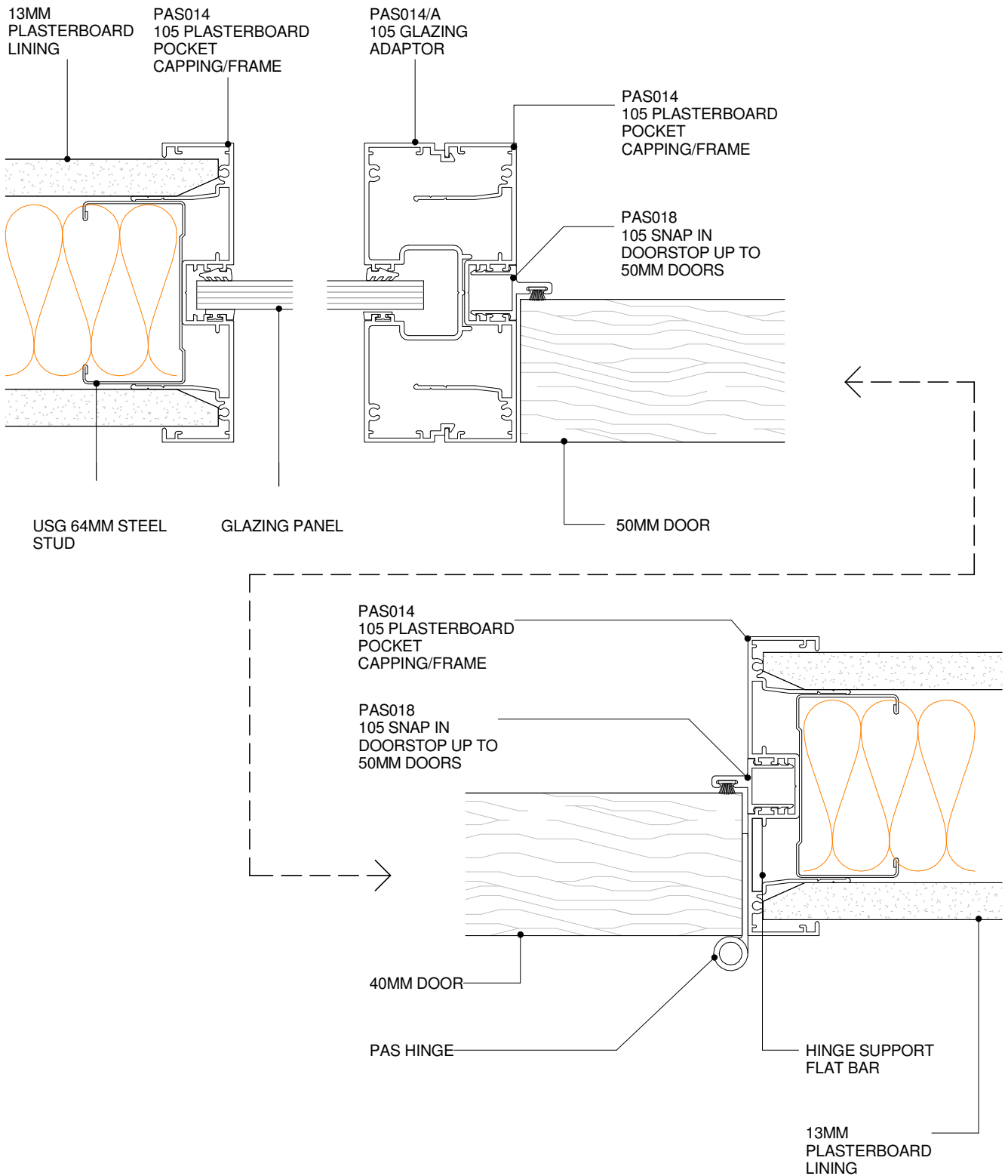

POTTER ALUMINIUM SYSTEMS
A SERIES 105 - 50MM DOOR TO HEADTRACK
PLAN VIEW

2.6.4

SHEET

1 : 2 @ A4
 SCALE

10/01/2011
 ISSUED DATE

0800 POTTER (0800 768 837) WWW.POTTERS.CO.NZ
 DETAILS SUBJECT TO CHANGE WITHOUT NOTICE

CSR

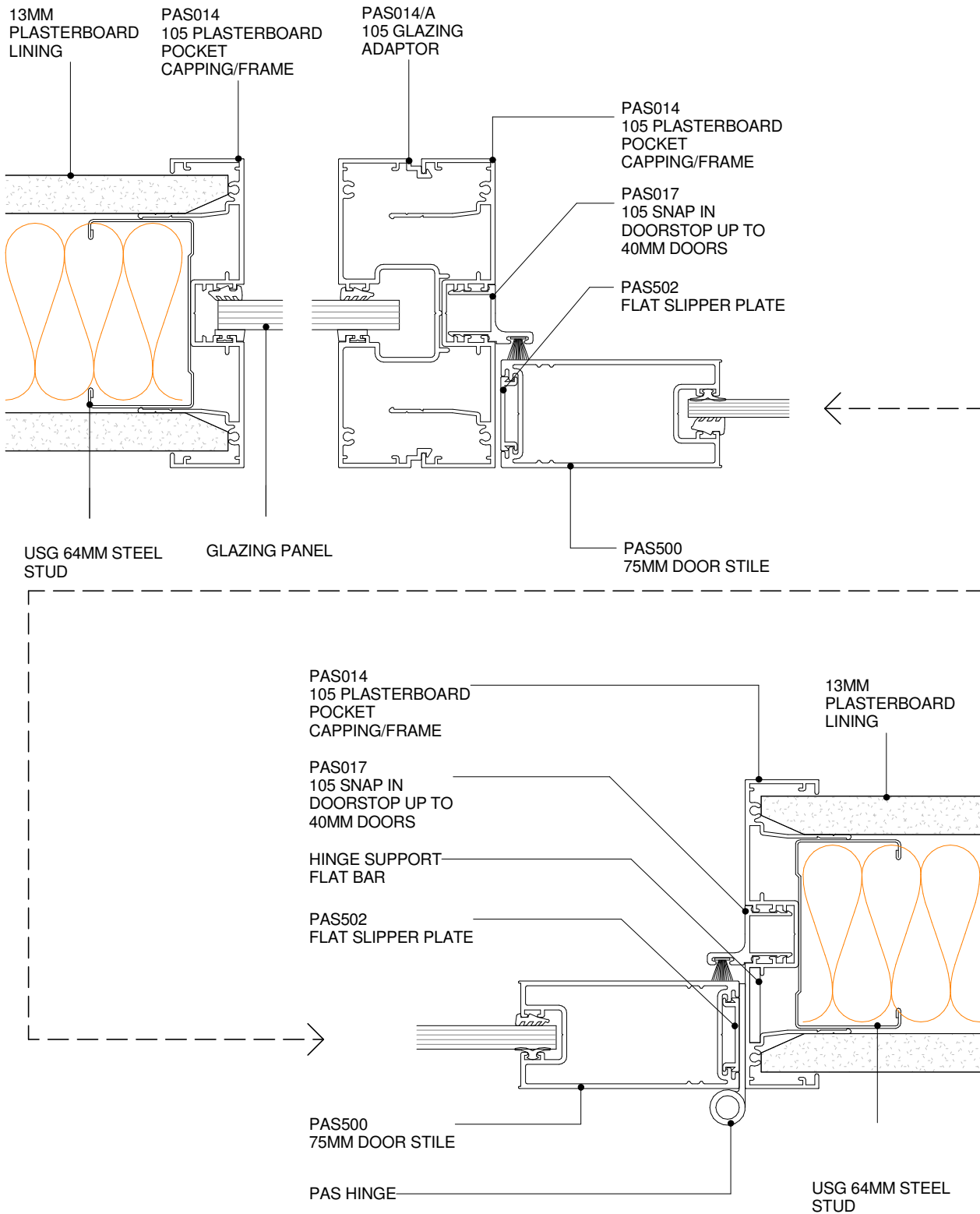

POTTER ALUMINIUM SYSTEMS
A SERIES 105 50MM - MULLION & DS SERIES 75MM DOOR
PLAN VIEW

2.6.5

SHEET

1 : 2 @ A4
 SCALE

10/01/2011
 ISSUED DATE

0800 POTTER (0800 768 837) WWW.POTTERS.CO.NZ
 DETAILS SUBJECT TO CHANGE WITHOUT NOTICE

CSR

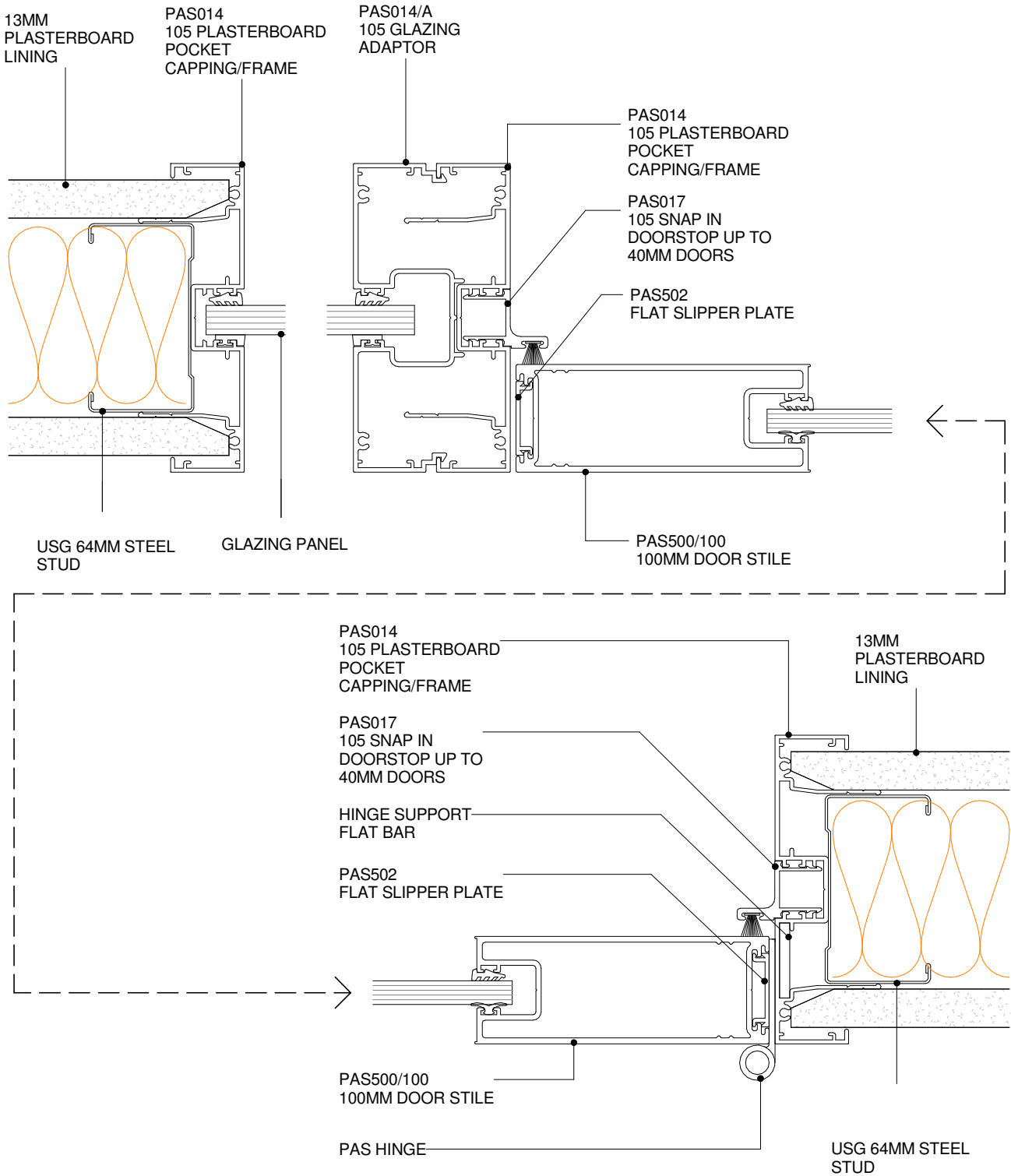

POTTER ALUMINIUM SYSTEMS
A SERIES 105 50MM - MULLION & DS SERIES 100MM DOOR
PLAN VIEW

2.6.6
 SHEET

1 : 2 @ A4
 SCALE

10/01/2011
 ISSUED DATE

0800 POTTER (0800 768 837) WWW.POTTERS.CO.NZ
 DETAILS SUBJECT TO CHANGE WITHOUT NOTICE

CSR

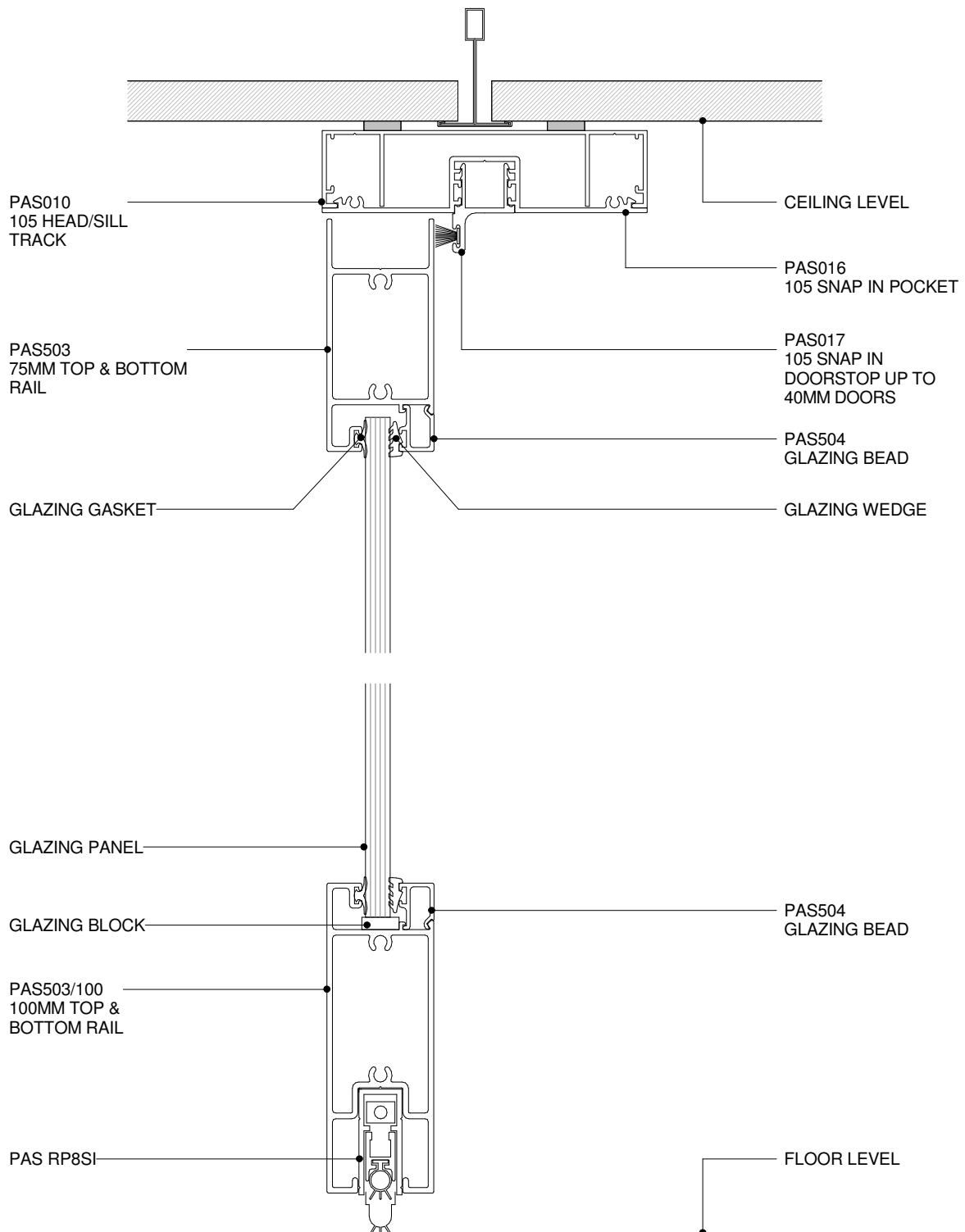

POTTER ALUMINIUM SYSTEMS
A SERIES 105 64MM - DS SERIES 100MM DOOR & RP8SI DOOR SEAL
CROSS SECTION

2.6.7

SHEET

1 : 2 @ A4
 SCALE

10/01/2011
 ISSUED DATE

0800 POTTER (0800 768 837) WWW.POTTERS.CO.NZ
 DETAILS SUBJECT TO CHANGE WITHOUT NOTICE



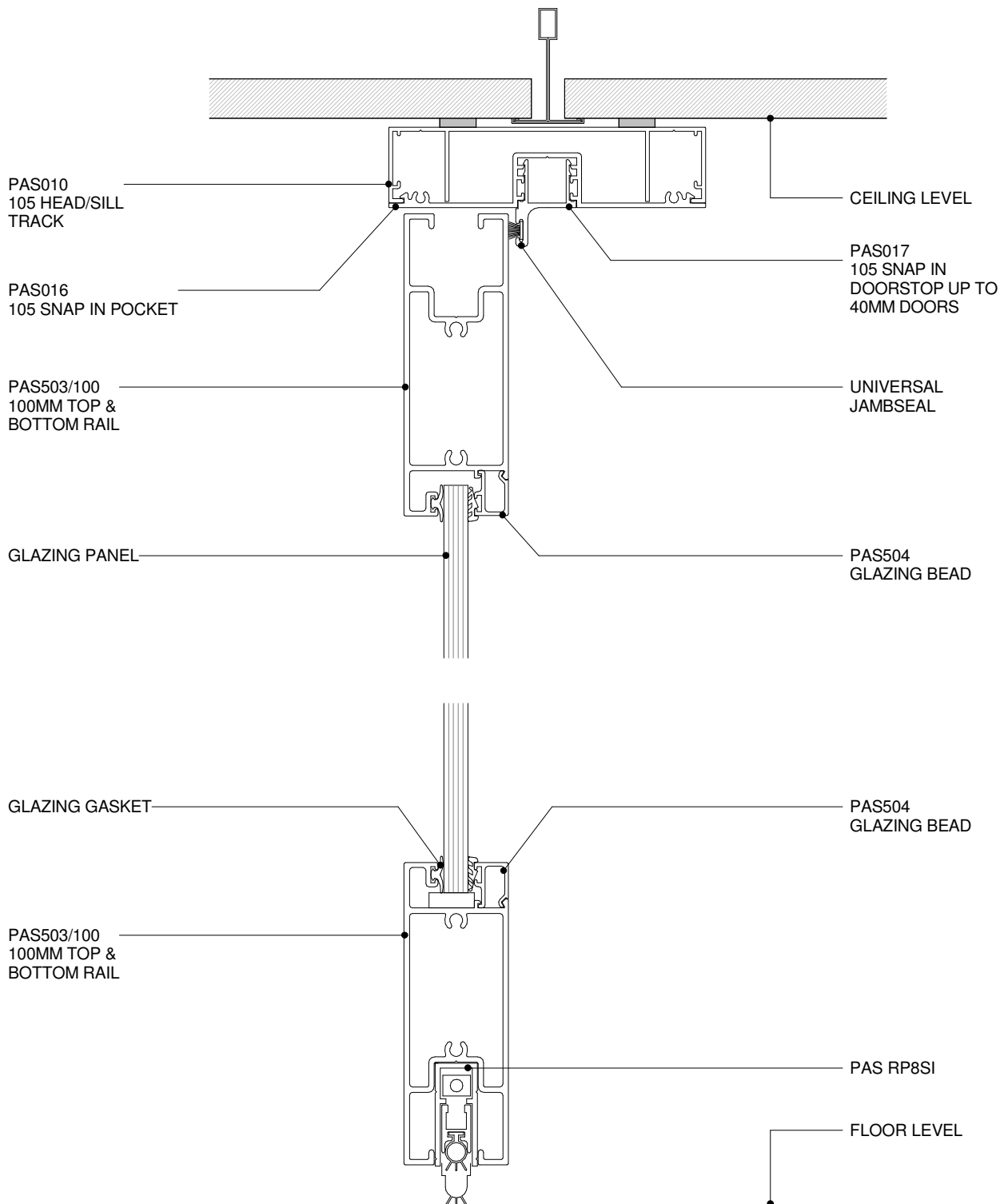

POTTER ALUMINIUM SYSTEMS
A SERIES 105 64MM - DS SERIES 100MM DOOR & RP8SI DOOR SEAL
CROSS SECTION

2.6.8

SHEET

1 : 2 @ A4
SCALE

10/01/2011
ISSUED DATE

0800 POTTER (0800 768 837) WWW.POTTERS.CO.NZ
DETAILS SUBJECT TO CHANGE WITHOUT NOTICE

CSR

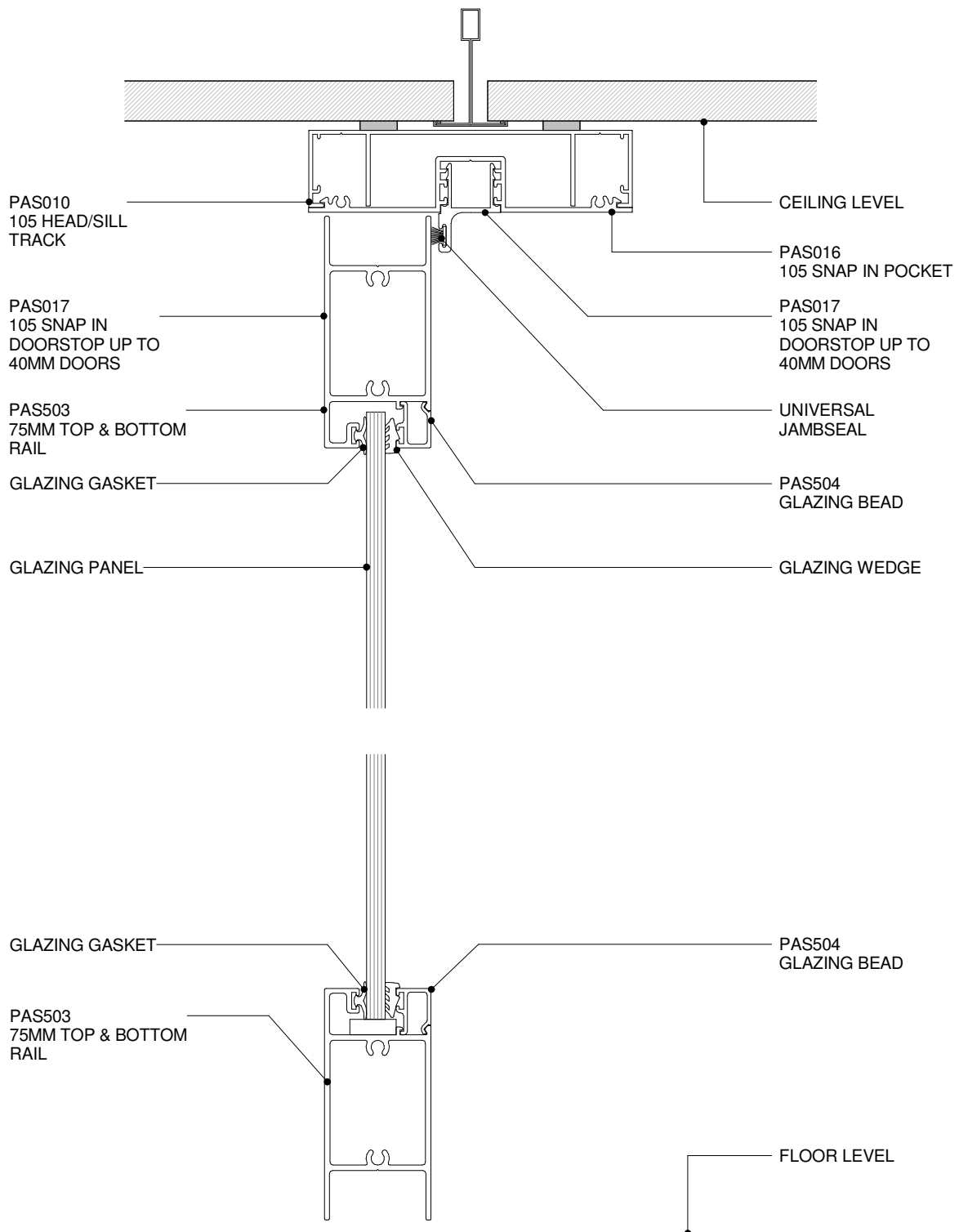

POTTER ALUMINIUM SYSTEMS
A SERIES 105 64MM - DS SERIES 75MM DOOR
CROSS SECTION

2.6.9
 SHEET

1 : 2 @ A4
 SCALE

10/01/2011
 ISSUED DATE

0800 POTTER (0800 768 837) WWW.POTTERS.CO.NZ
 DETAILS SUBJECT TO CHANGE WITHOUT NOTICE

CSR