

Installation instructions



Zenith HydroTap® G5

Model:

Command Centre (see table of contents for specific models)



HydroTap G5 specifications

Using these instructions & IMPORTANT SAFETY INSTRUCTIONS 4
 WARNINGS AND REGULATORY INFORMATION 6
 Technical data 8
 Supplied parts check list..... 10
 Installation check list 12
 Before Installation 13
 General product features 14

Installation instructions

Step 1 Measure and cut all the tap holes, fit the taps : Refer to Tap installation instructions supplied.

Step 2 Check for adequate ventilation.

Section 2 Ventilation.

Section 2.1 - 2.4 Ventilation for all models 15

Step 3 Install the booster / lime scale filter / water block / CO₂ & carbonation valve (if required).

Section 3 Ancillary installations

Section 3.1 Water block description 20

Section 3.2 Water block installation 21

Section 3.3 Connect the water supply 22

Section 3.4 Set the external scale filter bypass valve 23

Section 3.5 Lime scale filter installation 24

Section 3.6 Booster installation 25

Section 3.7 CO₂ cylinder and regulator installation 28

Section 3.8 Font installation 31

Step 4 Install the Command Centre.

Section 4 Commercial & Residential Command Centre installation.

Section 4.1 Generic Command Centre installation instructions 41

Section 4.2 BCS60 - BCS100 commercial installation 45

Section 4.3 BCS20 - BCS30 commercial and BCS Home installation 49

Section 4.4 BC40 - BC100 commercial installation 53

Section 4.5 BC20 - BC30 commercial and BC Home installation 57

Section 4.6 B60 - B100, BA60 - BA100 and B & BA Home installation 61

Section 4.7 CS100 commercial installation 67

Section 4.8 C40 - C100 commercial installation 69

Section 4.9 CS Home installation 71

Section 4.10 C Home installation 73

Step 5 Commission the HydroTap G5.

Section 5 Commissioning

Section 5.1 Generic commissioning instructions 75

Section 5.2 Select the language 75

Section 5.3 Filter flush 77

Section 5.4 Tank flush 77

Section 5.5 Boiling calibration 78

Section 5.6 CO₂ purge 78

Section 5.7 Booster enable 78

Section 5.8 Carbonation valve adjustment 79

Section 5.9 Safety sensor calibration (optional) 79

Trouble shooting





Section 6 Service, trouble shooting table 80

INSTALLATION INSTRUCTIONS Table of contents

Section 7 End of life disposal	81
Contact details, at end of document.....	123

Using these instructions

Explanation of symbols

					
Read the instructions	WARNING	DANGER Electric shock	DANGER Hot surface	DANGER Flammable	CO ₂ Gas WARNING

Safety instructions

 Read and use the instructions and safety information supplied with individual kit components for a safe installation.

IMPORTANT SAFETY INSTRUCTIONS



Compliance

In Australia/New Zealand electrical installation must comply with AS/NZS3000.
 In Australia/New Zealand plumbing installation must comply with AS/NZS3500.
 In Australia/New Zealand For residential chilled models, all refrigeration must comply with AS/NZS 60335.2.24.

Safety

This appliance is not intended for use by children under 8 years or persons (including children under 8 years) with reduced physical, sensory or mental capabilities, or lack of experience and knowledge, unless they have been given supervision or instruction concerning the use of the appliance by a person responsible for their safety. Children should be supervised to ensure that they do not play with the appliance.

Refrigerant



The Zenith HydroTap Command Centre range uses either HIGHLY FLAMMABLE R290, R600a or R134A refrigerant under pressure.

Check the rating plate or contact Zenith before commencing work.

Maintenance of the refrigeration unit must be carried out by an accredited service provider or qualified refrigeration technician.

Keep ventilation openings, in the appliance enclosure or in the built-in structure, clear of obstruction. Do not use mechanical devices or other means to accelerate the defrosting process, other than those recommended by the manufacturer.

Do not store explosive substances such as aerosol cans with a flammable propellant in this appliance.

CO₂

- Keep out of reach of children.
- Use according to MSDS (material safety data sheet).
- Pressurised container. Contains gas under pressure, may explode if heated.



IMPORTANT SAFETY INSTRUCTIONS

- Protect from sunlight.
- Do not expose to temperatures exceeding 50°C.
- Do not expose to naked flame or any incandescent material.
- Do not pierce or burn, even after use. Avoid shock.
- High concentration of gas may cause asphyxiation.
- Use only in an upright position.
- The cylinder must be used with the supplied pressure regulator.
- The gas cylinder must be installed in an open plan area, or in an enclosed room with a volume no less than 22m³ per 1200g cylinder, or 50m³ per 2640g cylinder.
- If more than 1 gas cylinder containing CO₂ is present within the same location, the recommended ventilated area should be in proportion to the number of gas cylinders stored in that location. A ventilated area is a non-enclosed area which could include the kitchen, living room etc.
- Refer to the gas cylinder and MSDS for a complete list of warnings (www.zenithwater.co.nz).

Qualifications

To avoid hazards, all installation procedures must be carried out by a suitably qualified tradesperson. The power cable and power outlet must be in a safe visible position for connection.

Venting

Sometimes steam and / or boiling water droplets may discharge through a vent outlet on the tap. If not using the font, ensure the tap body is located so the tap outlet safely dispenses into the sink bowl.

Lifting

Take care when lifting. The Command Centre may exceed safe lifting limits. If you feel this is beyond your personal capabilities, please seek assistance with the lift. The weight of the Command Centre is marked on the packaging. Do not lift the Command Centre by the front cover or any of its connections.

Airflow

The Zenith HydroTap operates within the ambient temperature range 5°C - 35°C. Proper air circulation must be provided. The system will operate satisfactorily only if the recommended air gaps are provided. The vent kit supplied must be fitted.

Altitude

Water boils at varying temperatures at different altitudes. The HydroTap adjusts for this during startup calibration and will recalibrate itself on a regular basis.

Frost protection

If the HydroTap is located where the ambient air temperature could fall below 5°C when the system is not in use, do not turn off the Command Centre electrically. This safeguard does not offer the same protection to the connecting pipework and fittings.

Application

The HydroTap G5 Home series is intended to be used in household and similar applications such as:

- Staff kitchen areas in shops, offices and other working environments;
- Farm houses and by clients in hotels, motels and other residential type environments;
- Bed and breakfast type environments;
- Catering and similar non-retail applications.

WARNINGS AND REGULATORY INFORMATION



- For continued safety of this appliance it must be installed, operated and maintained in accordance with the manufacturer's instructions.



- This appliance may deliver water at high temperature. Refer to the Plumbing Code of Australia (PCA), local requirements and installation instructions to determine if additional delivery temperature control is required.



- The Zenith HydroTap must be earthed, earthing is provided via the supplied power cord. The resistance of the earth connection to each exposed metal part must be less than 1Ω. Use the power cable supplied. It is the responsibility of the installer to ensure the power point is earthed.



- All installation and service work must be completed by trained and suitably qualified tradespeople. Faulty operation due to unqualified persons working on this product, may void warranty coverage.



- As the installer, it is your responsibility to supply and install all valves as required by local regulations and relevant standards.

- The HydroTap is rated for 220-240V 50Hz AC operation.

- Do not remove the cover of the appliance under any circumstances without first isolating the appliance from the power supply.

- Connect only to a potable (wholesome, cat1) mains water supply.

- Never locate the system near, or clean with water jets.

- Do not expose the Zenith HydroTap to the elements of nature.

- The booster complies with protection class IP 20.

- For UK, a pressure limiting valve must be fitted for mains water pressures above the max. limits stated.

- Use of tools can be hazardous, assess the risks before you start.

- A clearance envelope around all Command Centres must be provided to allow adequate ventilation for the safe and effective use of the HydroTap system.

- The vent tray, if provided, must be fitted. It provides a safe exhaust for refrigerant gas in the unlikely event of a leak.

- Valve and fitting threads must be sealed appropriately with PTFE tape where compression seals are not provided.

- Always flush new filter before use.

- Do not connect booster to electrical supply until commissioning.

- Do not over tighten plumbing and hose connections.

- Braided hoses supplied cannot be lengthened.

- Be aware of the risks of hazards which could cause harm when handling compressed CO₂. Assess the risks before starting the installation.

- Do not proceed with a CO₂ cylinder change if the seals are damaged. Take care not to cross thread the regulator, a cross threaded regulator poses a potential hazard.

- Care must be taken when working with high pressure carbon dioxide, and in no case should the normal operating pressure of 3.0 bar be exceeded.

- The power cord and general power outlet must be in a safe and accessible position after installation. When positioning the appliance, ensure the power supply cord is not trapped or damaged. If the power supply cord is damaged it must be replaced by a Zenith service provider or a qualified electrician.

- Do not locate multiple portable socket-outlets or portable power supplies at the rear of the appliance.

WARNINGS AND REGULATORY INFORMATION



- Do not locate multiple portable socket-outlets or portable power supplies at the rear of the appliance.



- For safe operation, the HydroTap is designed to be installed, commissioned and used within 48 hours. Should the HydroTap not be required for an extended period of time (72 hours or more), do not fill and commission the HydroTap until ready for first use.



- For water taste and quality reasons, following any non-use period of more than 72 hours, Zenith recommends to perform a system flush. Failure to flush the system may affect water quality.



- For UK, this appliance incorporates adequate backflow prevention in accordance to S.I.1999 No.1148 The Water Supply (Water fittings) Regulations 1999 Schedule 2 requirement. No further backflow prevention is required for connection to the water supply.

- For UK, this appliance only contains materials that conform to the requirements of BS6920:2014 'Suitability of non metallic materials and products for use in contact with water intended for human consumption with regard to their effect on the quality of water'.



- Use the new hose set supplied with the unit. Do not re-use old hose set.

Technical data

Technical data table

Model	Power rating kW 220-240V 50Hz	Power rating kW 220V 60Hz	Dimensions W x D x H (mm) Command Centre only	Dimensions including Duct W x D x H (mm) Vent tray additional measurements in ()	Weight (kg)
Boiling Chilled Sparkling models					
BCS100 BCS100 H	2.15 + Booster	2.05 + Booster	395 x 464 x 333	450 (500) [#] x 464 (520) [#] x 333 (373) [#]	41
BCS60 BCS60 H	2.15	2.05	395 x 464 x 333	450 (500) [#] x 464 (520) [#] x 333 (373) [#]	41
BCS30 BCS30 H	1.96 + Booster	1.86 + Booster	339 x 460 x 333	N/A	34
BCS20 BCS20 H	1.96	1.86	339 x 460 x 333	N/A	34
BCS Home BCS H Home	1.53	1.45	339 x 460 x 333	N/A	34
Boiling Chilled models					
BC100 BC100 H	2.1 + Booster	2.00 + Booster	395 x 464 x 333	450 (500) [#] x 464 (520) [#] x 333 (373) [#]	30
BC60 BC60 H	2.1	2.00	395 x 464 x 333	450 (500) [#] x 464 (520) [#] x 333 (373) [#]	30
BC40 BC40 H	1.97	1.84	395 x 464 x 333	450 (500) [#] x 464 (520) [#] x 333 (373) [#]	30
BC30 BC30 H	1.9 + Booster	N/A	280 x 455 x 333	N/A	23
BC20 BC20 H	1.9	N/A	280 x 455 x 333	N/A	23
BC Home BC H Home	1.44	N/A	280 x 455 x 333	N/A	30
Boiling, Boiling Ambient models					
B100, BA100	1.8 + Booster	1.65 + Booster	280 x 313 x 333	N/A	13
B60, BA60	1.8	1.65	280 x 313 x 333	N/A	13
B, BA Home B H Home	1.35	1.24	280 x 313 x 333	N/A	13
Chilled Sparkling, Chilled models					
CS100	0.37	0.410	280 x 480 x 333	330 (500) [#] x 480 (520) [#] x 333 (373) [#]	36.5
C100	0.34	0.37	280 x 476 x 333	330 (500) [#] x 476 (520) [#] x 333 (373) [#]	24.2
C40	0.16	0.19	280 x 476 x 333	330 (500) [#] x 476 (520) [#] x 333 (373) [#]	24.2
CS Home	0.18	0.21	280 x 406 x 333	N/A	30
C Home	0.17	0.20	280 x 406 x 333	N/A	21

[#]Including vent tray
Please leave 60mm clearance above the rear of the Command Centre for all water connections.

Electricity supply requirements

220-240V 50Hz AC (for power requirement see table above).

220 60Hz AC.

Country	Without Booster	With Booster
Australia	1x 220 - 240V AC 10A socket	2x 220 - 240V AC 10A sockets
UK	1x 220 - 240V AC 13A socket	2x 220 - 240V AC 13A sockets

Water supply pressure requirements

Component	Min - Max pressure, kPa (bar)
HydroTap	170 (1.7) - 700 (7.0)
Sparkling HydroTap	250 (2.5) - 700 (7.0)
Vented Mixer Tap	300 (3.0) - 700 (7.0)
Booster	200 (2.0) - 700 (7.0)
Lime scale filter	200 (2.0) - 700 (7.0)



UK models: A pressure limiting valve must be fitted for mains water pressures above the maximum limits stated above, in accordance with local plumbing regulations.

All other models (except UK): HydroTaps have an internal pressure limiting device to reduce the maximum mains regulated pressure, protecting the system against pressure surges above 500 kPa.

Water supply connection

1/2" BSP (G1/2)

Booster specification

Specification	Rating
Power 230V 50/60Hz	2.20 kW
Power 240V 50/60Hz	2.40 kW
Flow rate	1.2 L/min

Supplied parts checklist

BCS, BC, B, BA models

Parts supplied in the kit	HydroTap								
	BCS for Work	BCS H for Work	BCS for Home	BCS H for Home	BC for Work	BC H for Work	BC for Home	B, BA for Work	B, BA for Home
Tap									
HydroTap tap, pipes, tubes hoses and fittings					✓				
Vented Mixer Tap, hoses, fittings & instructions	✗	✓	✗	✓	✗	✓	✗	✗	✗
Mains Mixer Tap, hoses, fittings & instructions	Optional								
Command Centre									
Command Centre					✓				
Mains electrical supply cable					✓				
Water supply inlet hose					✓				
Water supply inlet adaptor and strainer					✓				
Ventilation kit (inc. vent tray, Chilled 60 - 100 models)					✓				
Water block kit									(UK only)
CO₂									
CO ₂ cylinder & instructions		✓		✓			✗		
CO ₂ regulator & hose		✓		✓			✗		
CO ₂ regulator adaptor*		(UK only)		✓			✗		
Booster									
Booster & hoses		Optional		✗		Optional	✗	Optional	✗
Filters									
Water filter & instructions					✓				
Lime scale filter kit						Optional			
Font									
Font kit						Optional			

Note Mains water isolation valve is not supplied with the kit.

Contact Zenith for the full range of consumables and accessories.

Supplied parts checklist

CS & C models

Parts supplied in the kit	HydroTap			
	CS for Work	CS for Home	C for Work	C for Home
Tap				
HydroTap tap, pipes, tubes hoses and fittings		✓		
Vented Mixer Tap, hoses, fittings & instructions		✗		
Mains Mixer Tap, hoses, fittings & instructions		Optional		
Command Centre				
Command Centre		✓		
Mains electrical supply cable		✓		
Water supply inlet hose		✓		
Water supply inlet adaptor and strainer		✓		
Ventilation kit (inc. vent tray 100 models)		✓		
Water block kit		(UK only)		
CO₂				
CO ₂ cylinder & instructions	✓		✗	
CO ₂ regulator & hose	✓		✗	
CO ₂ regulator adaptor*	(UK only)		✗	
Booster				
Booster & hoses	✗		✗	
Filters				
Water filter & instructions		✓		
Lime scale filter kit		✗		
Font				
Font kit		Optional		

Note Mains water isolation valve is not supplied with the kit.

Contact Zenith for the full range of consumables and accessories.

Installation checklist



- Check if there is adequate space to install all of the components.
- Note Not all fittings are supplied with the appliance kit. Isolation valves are not supplied.
- Check the mains water pressure is within min / max requirements (see page 9).
- Check the water quality to determine if extra filtration will be required.
- Note This product must be fitted to a wholesome water supply.
- Check the Command Centre rating plate and ensure correct power is available.
- Check the under counter cupboard floor supporting the Command Centre is adequate for its total weight, when full of water.



Before commissioning

- Check the system has been installed correctly.
- Check all plumbing fittings for water tightness.
- Ensure the outlet and vent pipes are positioned to drain correctly.
- Ensure there is adequate ventilation.
- Check all tubes and pipes from the Command Centre to the tap have a constant rise and there are no sags or kinks in the hoses.



Commissioning

- Flush the supply line before connecting.
- Turn on the water and check for leaks.
- Flush the filter(s).
- Activate / enable the booster (if fitted).
- Adjust the carbonation flow valve (sparkling models).
- Calibrate the safety sensor for boiling models (optional).
- Where applicable, programme the Command Centre to suit the customer's requirements.

Before installation



- Review of all the technical specifications.
- Ensure the under counter cupboard floor can support the product weight when full of water (allow an extra 3-8kg when full).
- Sufficient space in the cupboard to install the Command Centre and other components in accordance with these installation instructions. See Technical data, page 8 for dimensions. Make allowance for a booster if required.
- **Note** Check all cable and hose lengths against inlet /outlet positions before proceeding (see Section 4 for general layout).
- A Potable (wholesome) water supply connection with a minimum working pressure of: (see page 9 min. / max. water supply pressure) with isolating valve inside the cupboard within reach of the braided hoses and positioned so that the connection point and the stop cock will not be obstructed when the Command Centre is installed.
- For the All-in-One Classic, Celsius and Mains mixer taps a hot and cold water supply are required. (see page 9 for min /max. water supply pressure).
- If external filtration or a lime scale protection filter is required, then it is important to allow extra space for it.
- The appliance must be placed with its base in a horizontal position.
- Ensure proper ventilation for CO₂ (see Important safety instructions, Warnings and regulatory information).

IMPORTANT! Do not proceed with the installation if these requirements are not met.

Thank you for purchasing a Zenith HydroTap G5. Please read and follow these instructions carefully to ensure safe and trouble free operation.

If help and advice is required, contact your local service provider.

What is the Zenith HydroTap G5?

This Zenith HydroTap G5 is an electronically controlled, filtered, boiling, chilled and sparkling (functionality is dependant upon model purchased) drinking water system for the kitchen. The HydroTap G5 systems are under counter drinking water appliances with a dispensing tap mounted on a sink or worktop, which have been designed for commercial or residential applications. The HydroTap G5 utilises a conventional refrigerant compressor to chill the water and an immersion heating element to boil the water.

These units are NOT designed to be used solely as sanitary fixtures.

The Zenith HydroTap G5 models which dispense boiling water are fitted with a tap mounted safety lock. In addition, there are various energy saving options accessible via the main menu. The system is equipped with a self-calibrating program which caters for altitude adjustment. The water filter and CO₂ gas cylinder (sparkling models) are disposable items which will require periodic replacement and are covered by a limited OEM warranty.

It is important that the installation be undertaken safely, correctly and completely in order to utilise all the benefits that the HydroTap G5 can provide. Classic taps can be ordered with the accessible tap head assembly, supplied with Braille caps.



Command Centre

2.1 Generic requirements

- The system must be provided with adequate ventilation and air circulation in order to operate efficiently.
- An exhaust outlet is necessary to provide a safe exhaust for refrigerant gas in the unlikely event of a leak.
- It is important to ensure that cool air is provided within the cabinet where the HydroTap is installed, under a forced ventilation system, to support removal of heat.
- Ventilation of hot air out of the cabinet is necessary to ensure the ambient temperature in the cabinet remains below 35°C.
- Continued operation at a higher temperature will affect the function and reduce the lifespan of internal components and increase the likelihood of failure.
- Should the temperature within the cabinet rise above 35°C, additional ventilation is required. Contact your local service provider for options (including additional vents and fan kit).



A clearance envelope around all Command Centres must be provided to allow ventilation for the safe and effective use of the HydroTap system.



Read and use the instructions and safety information supplied with individual kit components for a safe installation.

Clearance envelope

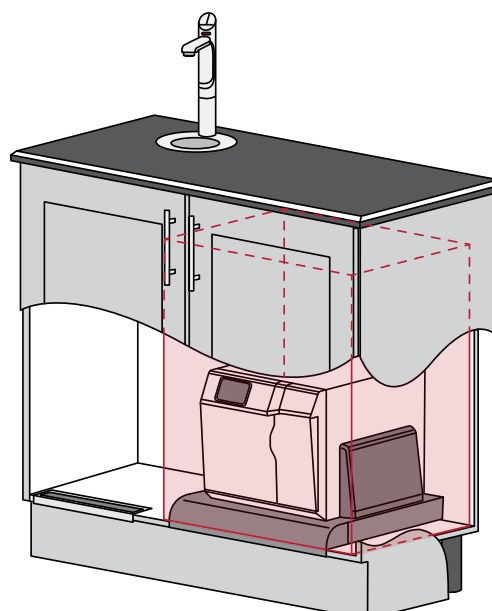
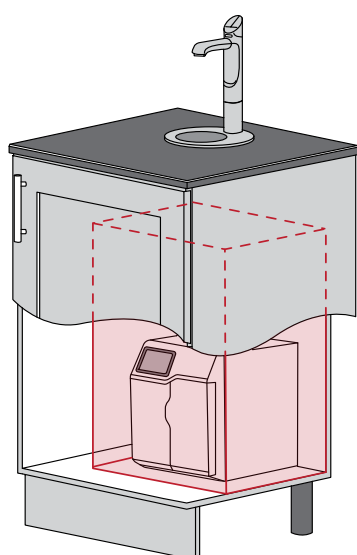
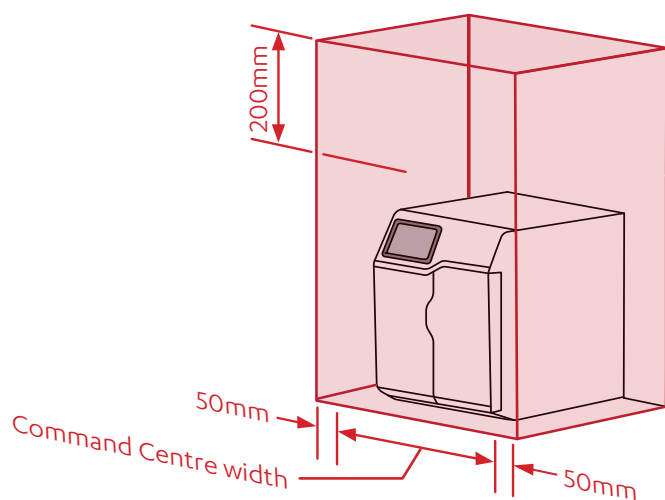

Ventilation options

HydroTap is supplied with one of three ventilation types. Follow the instructions to suit your model.

Front vent

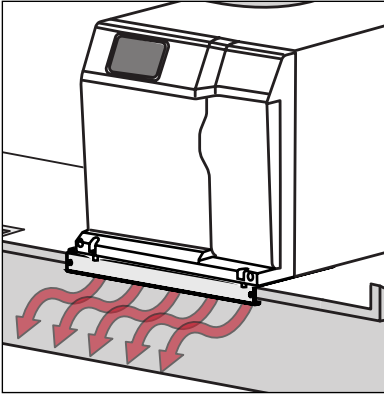

Side vent & tray

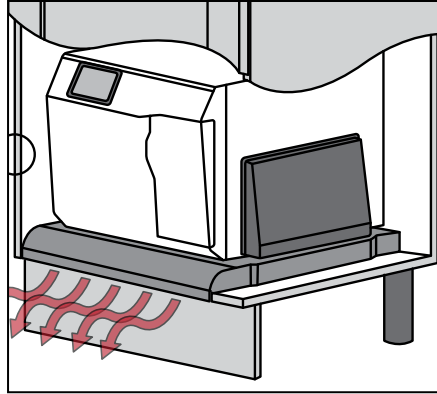

Ambient ventilation

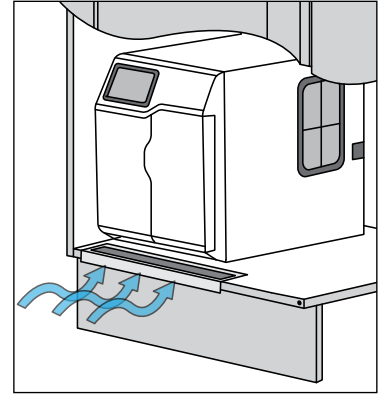

Section 2 Ventilation

2.2 Models with side vent and tray (BCS60, BCS100; BC40, BC60, BC100; CS100, C100)

- Cold air is drawn in through the inlet vent and gap provided by the door buffers.
- The inlet vent is positioned in the cupboard side, door or floor.
- Warm air is exhausted through vent tray.
- Observe 100mm inlet / outlet vent separation.

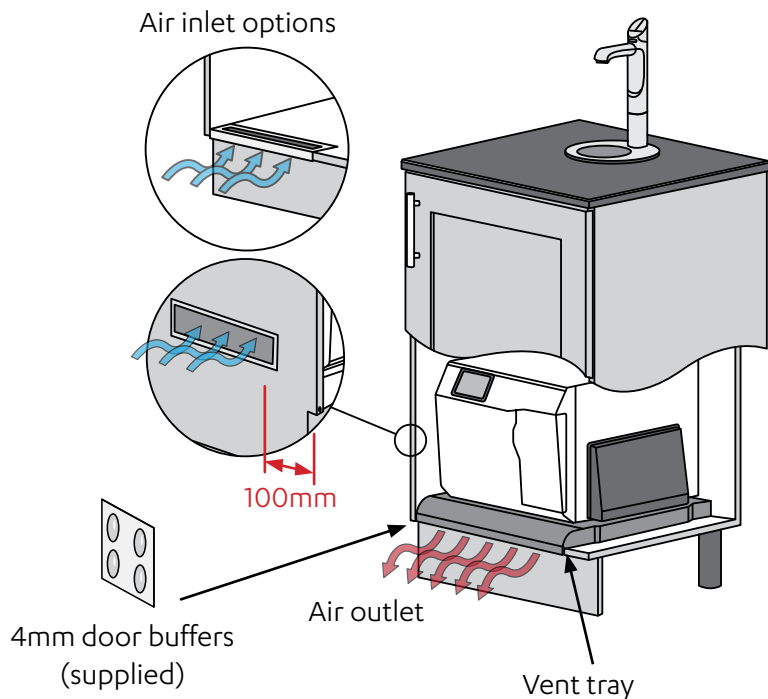

The supplied vent tray must be fitted. It provides a safe exhaust for refrigerant gas in the unlikely event of a leak.

Vent tray exhaust cut-out

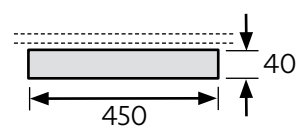

Vent tray dimensions
WxDxH (mm):
500 x (515-555) x 40

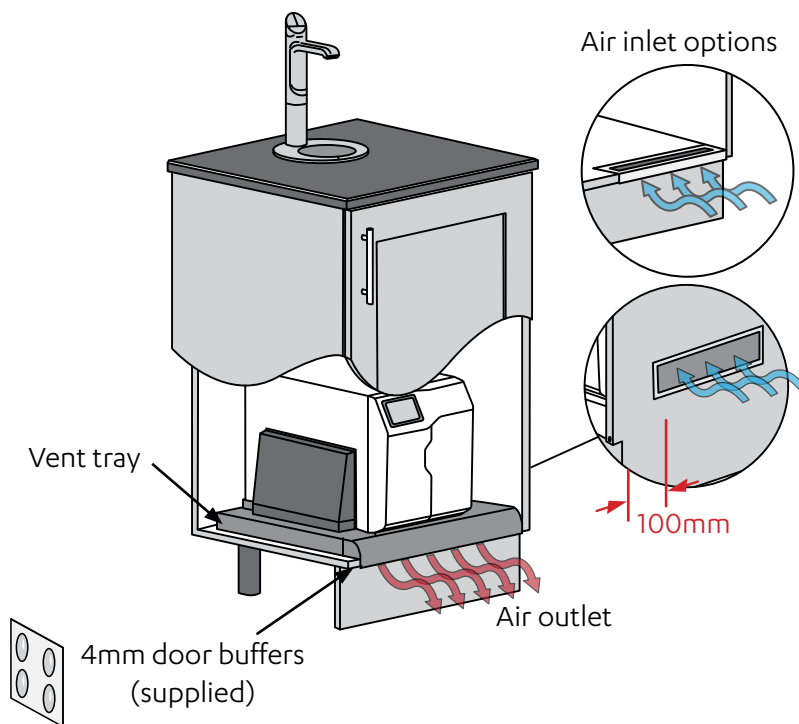

2.3 Models with front vent (BCS20, BCS30 & BCS Home; BC20, BC30 & BC Home, C40, CS Home, C Home)

- Cold air is drawn in through the inlet vent and gap provided by the door buffers.
- The inlet vent is positioned in the cupboard side, door or floor.
- Warm air is exhausted through the base of the Command Centre, through the cupboard floor cut-out.
- Observe 100mm inlet / outlet vent separation.



The cupboard exhaust must be cut out. It provides a safe exhaust for refrigerant gas in the unlikely event of a leak.

- a** Air inlet cut-out options (refer to the instructions provided with the vent grilles)

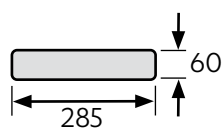

- b**
-

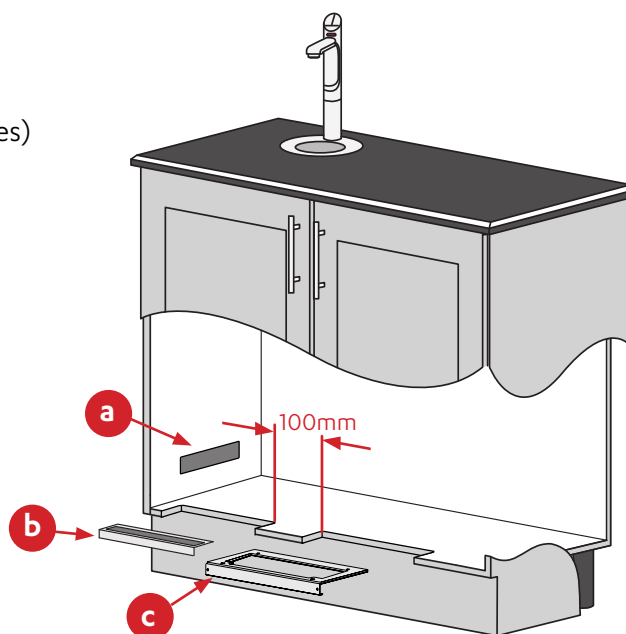

- c** Air exhaust vent cut-out.
Check size relative to your product.

For Command Centre width 280mm



For Command Centre width 339mm

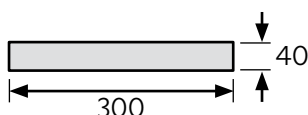

- Align the mounting plate to the edge of the cupboard floor, and secure with the 2 self-tapping screws supplied.
- Then, secure Command Centre to mounting plate with 2 screws supplied.

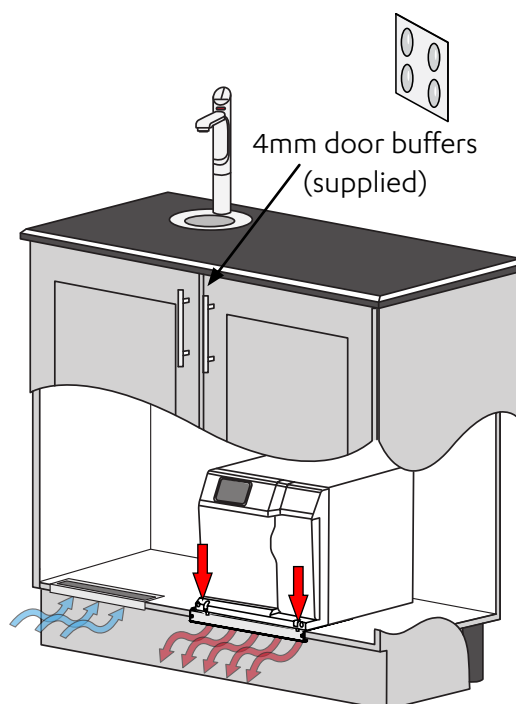

2.4 Ambient vented models (BCS20, BCS30 & BCS Home; BC20, BC30 & BC Home, C40, CS Home, C Home; B60, B100, BA60, BA100, B Home, BA Home)



This ventilation system must NOT be used for models utilising R290 refrigerant, including ALL UK chilled models. In the unlikely event of a leak, this system will NOT adequately vent the refrigerant.

- Cold air is drawn in through the inlet vent and lower gap provided by the door buffers.
- The inlet vent is positioned in the cupboard side, door or floor.
- Warm air is exhausted through upper gap provided by the door buffers.

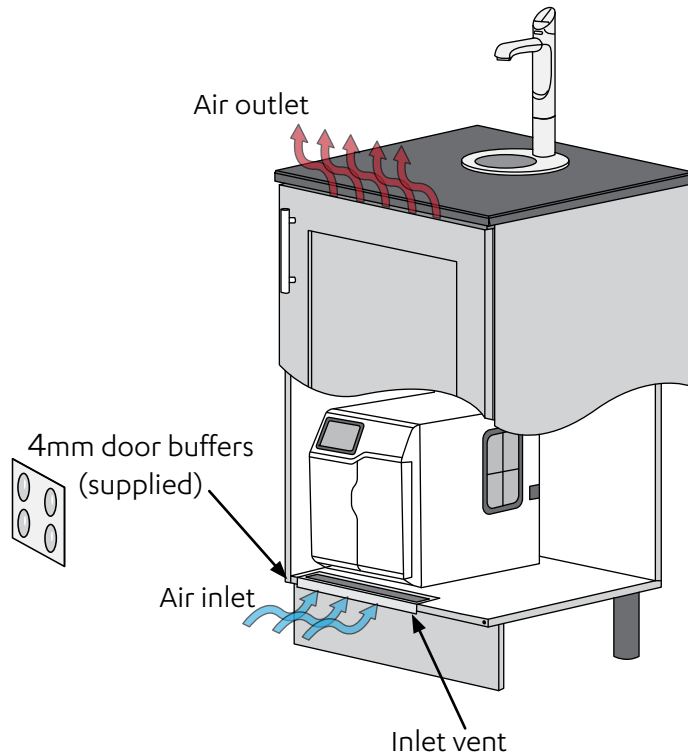

Section 3.1 Water Block description (optional accessory)



The HydroTap has an internal leak detection system that will automatically shut off water supply into the product, should a leak occur internally. For external leaks that cannot be protected by the HydroTap, consider using a Water Block. For UK, the Water Block is a recommended installation requirement.

3.1.1 Description

- The Water Block is designed to be installed upstream of any Zenith product and associated pipe-work to minimise the potential for water leakage in the event of a system malfunction.
- The Water Block is ideal for limiting potential leakage and resulting water damage from water heaters, water chillers etc. when fitted in supply pipe work that is subject to mains water pressure.
- Once set, the Water Block will ensure that the volume of water that can flow through at one time is limited to a pre-determined maximum, providing the flow rate through it exceeds 2 litres per minute.
- The Water Block also incorporates a non-return valve.

3.1.2 Specification

Parameter	Specification
Flow control range	5 - 50 litres
Minimum / Maximum pressure	0.2 - 10.0 bar
Maximum ambient temperature	40°C
Maximum water temperature	70°C
Minimum operating flow rate	1.5 +/- 0.5 litres / min.
Inlet connection	¾" BSP female or 15mm
Outlet connection	¾" BSP male or 15mm

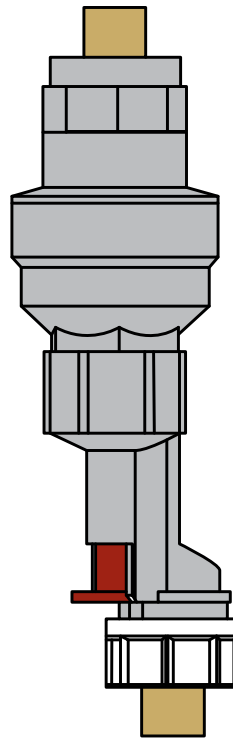

3.1.3 Precautions

- The Water Block will help to contain leakage exceeding a rate of 2 L/min.
- **Note** The leakage at lower flow rates may not be detected by the Water Block and could remain unchecked.
- Appropriate measures should be taken to contain leakage in these circumstances.

Section 3.2 Water Block installation (optional accessory)

3.2.1 Installation



This device must be installed vertically with the direction of flow downwards (inlet at the top, outlet at the bottom. See Fig.1 adjacent).

- The Water Block should be installed in a convenient location on the water supply line to the Zenith product.
- Pointer 'P' (see Fig.3) should be rotated until in line with the maximum required flow at one time. Each number on the scale corresponds to 5 litres of flow i.e. 1 = 5 litres, 10 = 50 litres.
- The adjustment key (see Fig.2) should be used to adjust the pointer.
- The inlet should be connected via an 15mm isolation valve (not supplied).
- The outlet shall be connected via the 15mm - 1/2" brass compression fitting supplied.
- Ensure that the direction of flow through the Water Block is correct and that the filter screen (see Fig.2) is inserted correctly with the convex surface facing towards the water supply.

Fig. 1

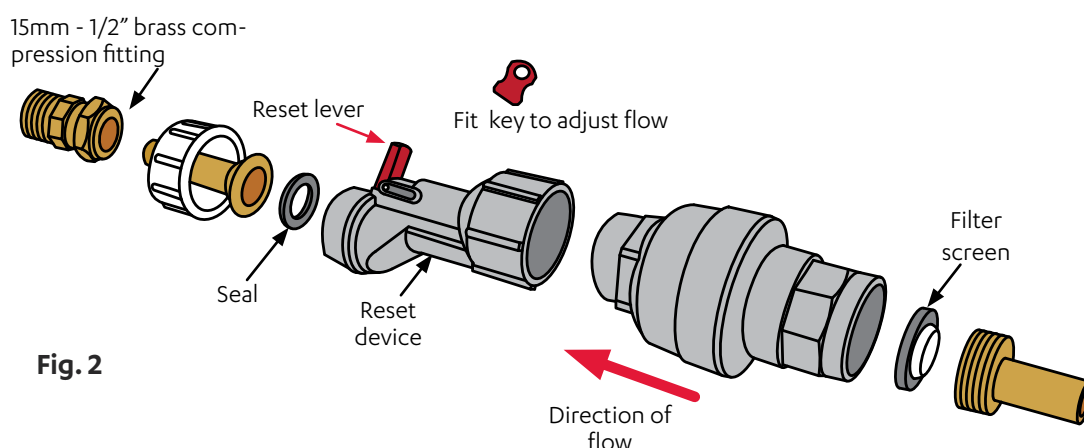
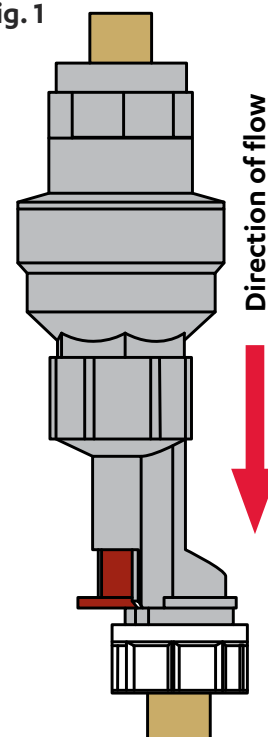

Fig. 2

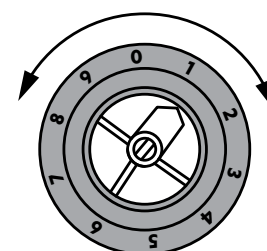

Fig. 3

3.2.2 Reset Procedure

- The Water Block will activate and shut off the supply if more water than the set amount is drawn off at one time.
- In this event firstly isolate and de-pressurise the water supply to the Water Block, identify and repair the cause of the leak then remove the pipe-work downstream of the Water Block and press the reset button 'H' (see Fig.3).
- The reset device (see Fig.2) may be fitted to avoid disconnection. This allows the Water Block to be reset by operating the lever in the direction shown in Fig.2.
- In the event of persistent tripping contact Zenith for advice.

3.2.3 Maintenance

- The filter screen should be checked and cleaned periodically subject to water conditions and usage.

3.3.1 Connect the braided hose to the mains water supply



Valves and fittings must be sealed with PTFE tape if compression seals are not included.

Note Mixer tap installations also use a 'Tee piece' as part of the water supply plumbing connections, see the Tap installation instructions supplied with the Mixer Tap to connect the water supply if using the mixer tap option.

Note correct strainer orientation.

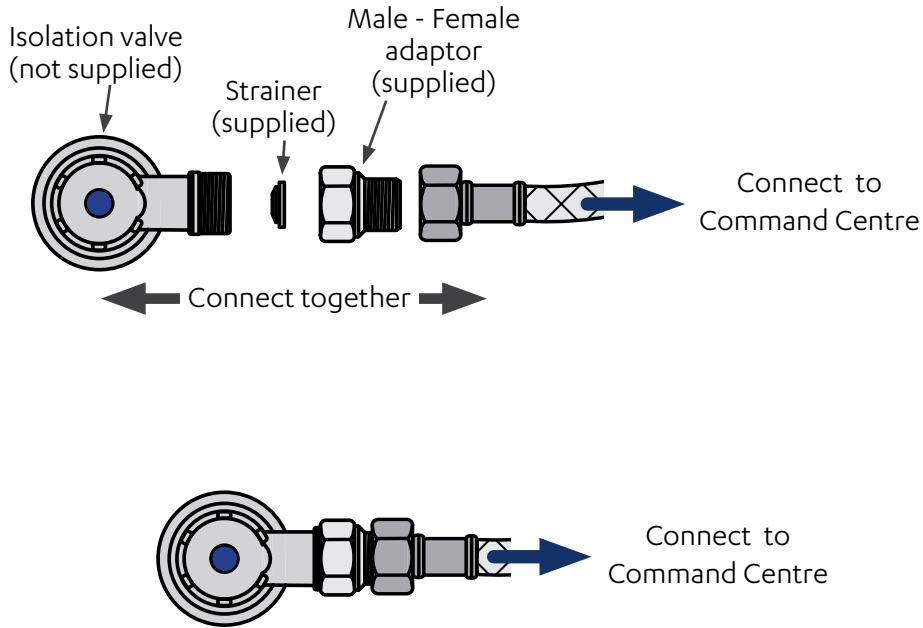

Section 3.4 Set the external Scale filter Bypass valve

3.4.1 External bypass valve

The following products have an external bypass valve

- Boiling and Ambient
- Boiling and Chilled
- Boiling, Chilled and Sparkling

The external bypass valve allows the user to choose to have the boiling feed water bypass the internal filter and only be filtered by the external filtration. This valve is located at the rear panel of the Command Centre.

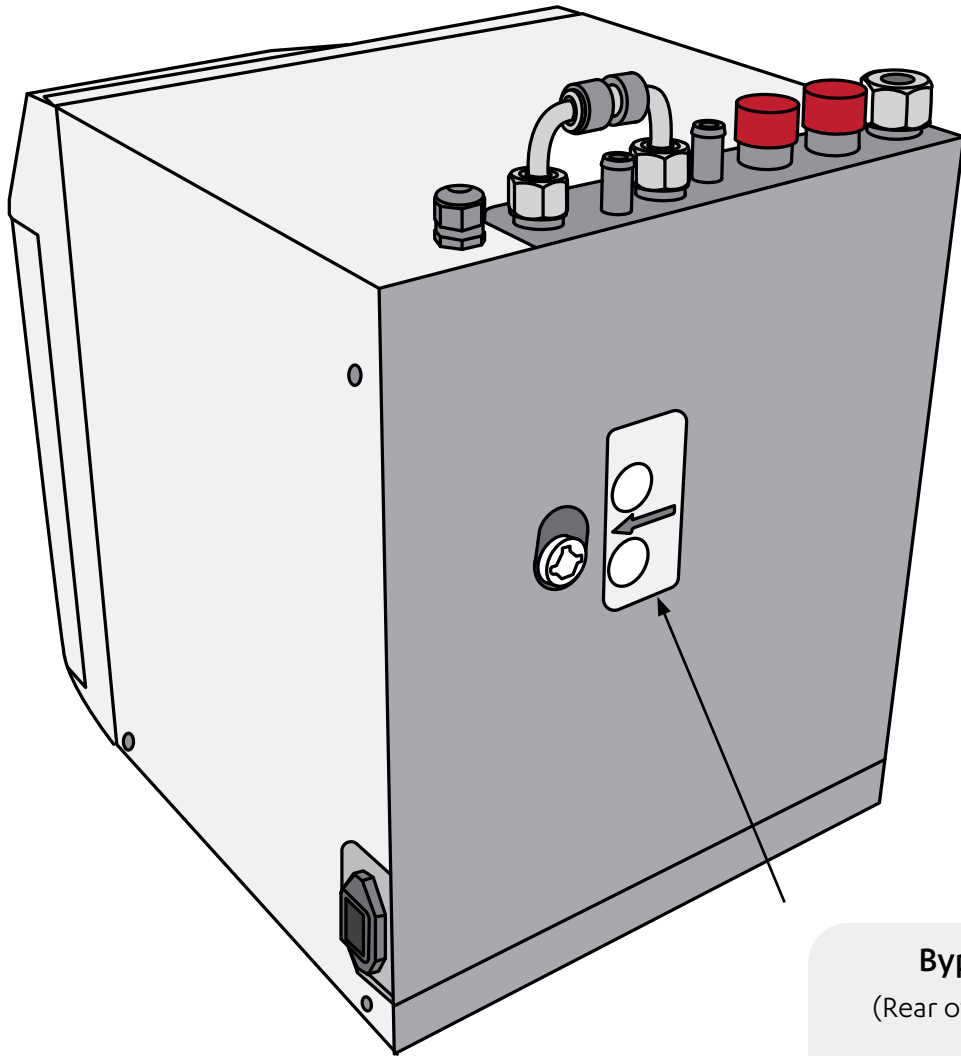

Bypass valve
(Rear of the Command Centre)

3.5.1 Lime scale filter

An external lime scale filter may be fitted as an optional accessory to reduce the incidence of lime scale build up in the hot tank or may be supplied at the customer's request.



For filter head and lime scale filter installation use the guide supplied with the filter head and filter respectively.

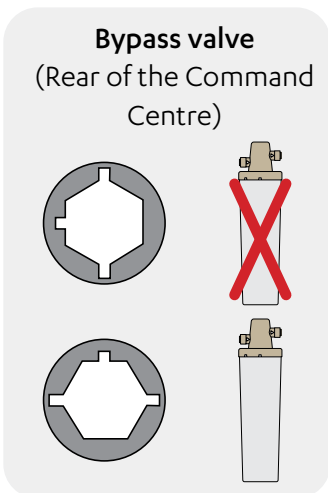
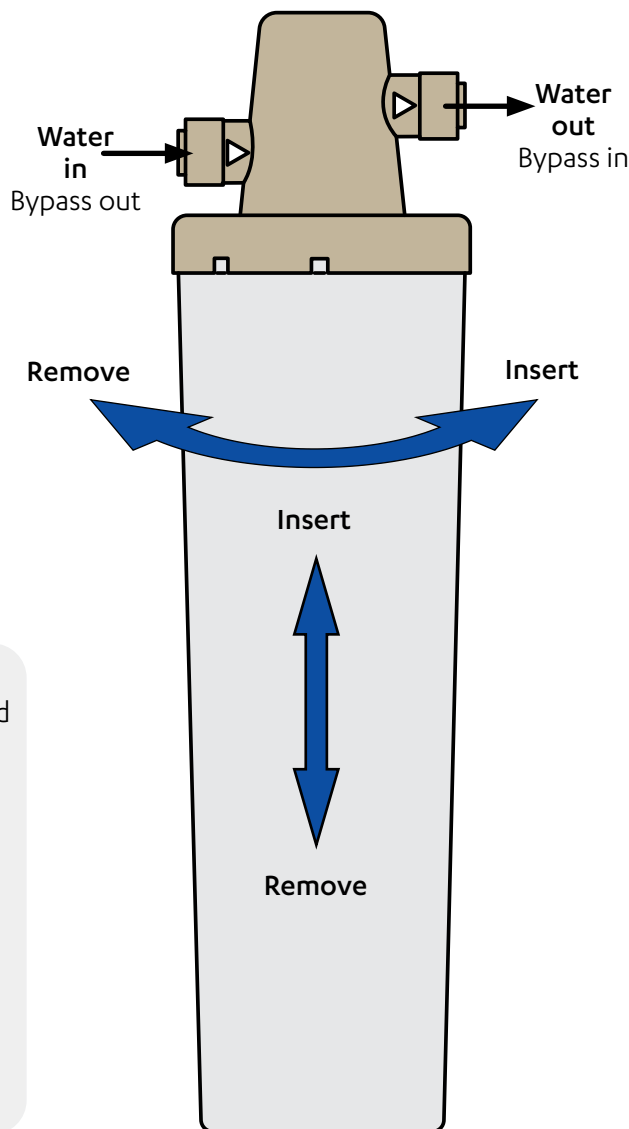
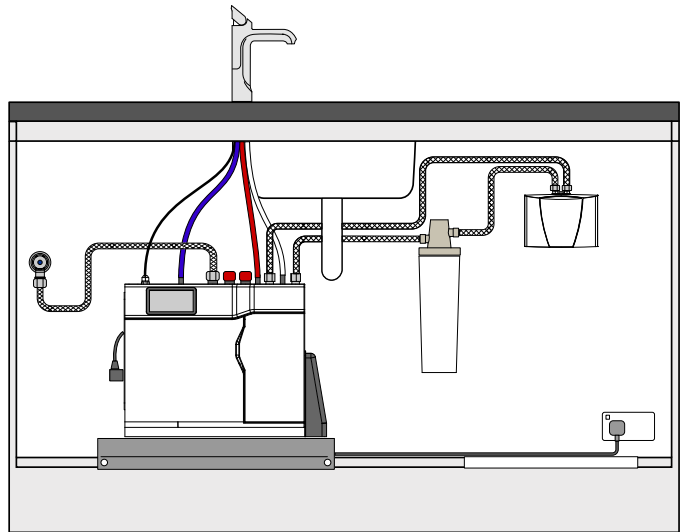



An external booster heater is supplied, or may be purchased as an upgrade to increase Boiling capacity, with selected commercial boiling models.

3.6.1 Booster description

The booster system is a compact electronically controlled auxiliary water heater. It is intended to provide pre-heating of water before it enters the Zenith HydroTap G5 boiling tank. If the booster is used the boiling water output will be increased.

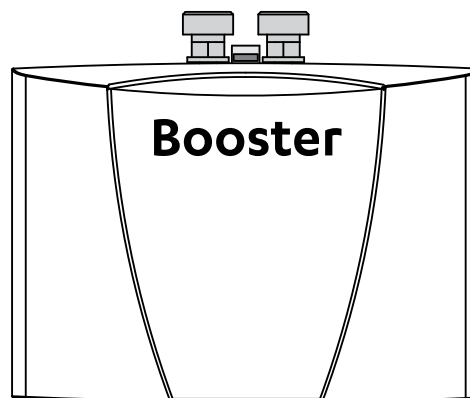

Note 1 Water connection blue cap - water in
red cap - water out.
The braided hoses cannot be lengthened.

Note 2 The electrical cable length is 0.6m.

Note 3 Position the booster within reach of the fixed hose lengths, keeping the booster as close as possible to the Command Centre inlet / outlet connections.

Note 4 Ensure the booster is mounted in an upright position (as shown) with a horizontal base.

Note 5 Before you install a booster, determine whether an external water filter / softener is required. If an external water filter / softener is required, the external bypass valve must be set correctly, see page 23.

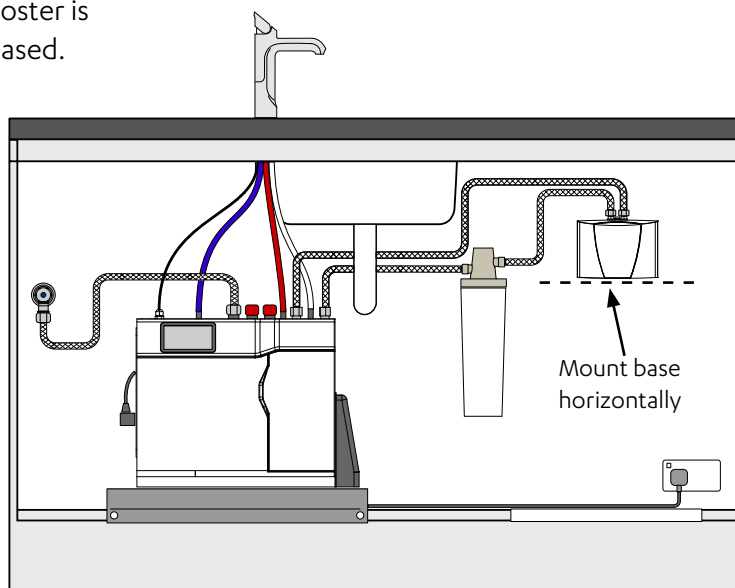

Booster specifications

	Rating	Unit
Nominal power rating	2.2	kW
Nominal current	10	A
Electricity supply 50Hz AC	230	V
Electrical flex, white - 0.6m nom. length	13	A
Fixed flow rate	1.2	L/min

Booster connections

- Cold water into Booster, connect to Command Centre BYPASS OUT.
- Hot water out of Booster, connect to Command Centre BYPASS IN.

3.6.2 Installation procedure

Site requirements

- Booster must only be installed in a frost-free area. Never expose booster to frost.
- The booster is designed for wall mounted installation and must be installed with water connectors facing upwards.
- The booster is protected against water ingress to class IP 25.
- The braided hoses supplied with the booster cannot be lengthened.
- The 90° elbow hose ends should be fitted to the inlet and outlet connections on top of the booster.
- The hot water outlet hose must be thermally insulated with the insulation provided.

3.6.3 Booster installation see diagrams below

- To remove the mounting chassis, insert a flat blade screwdriver all the way into the lock.
- Gently angle the screwdriver upwards by approximately 10°.
- Pull the booster forwards by approximately 15°. Carefully pull the booster upwards to complete the removal process. Take care not to break the lower clips.
- Attach the mounting chassis horizontally to the wall / cupboard wall.
- To install, clip the booster into the on the mounting chassis and snap into position (see installation below).

Note Remove the wall mounting chassis from the rear of the booster for wall mounting.

Note Take care not to break the lower clips when removing or installing the booster.

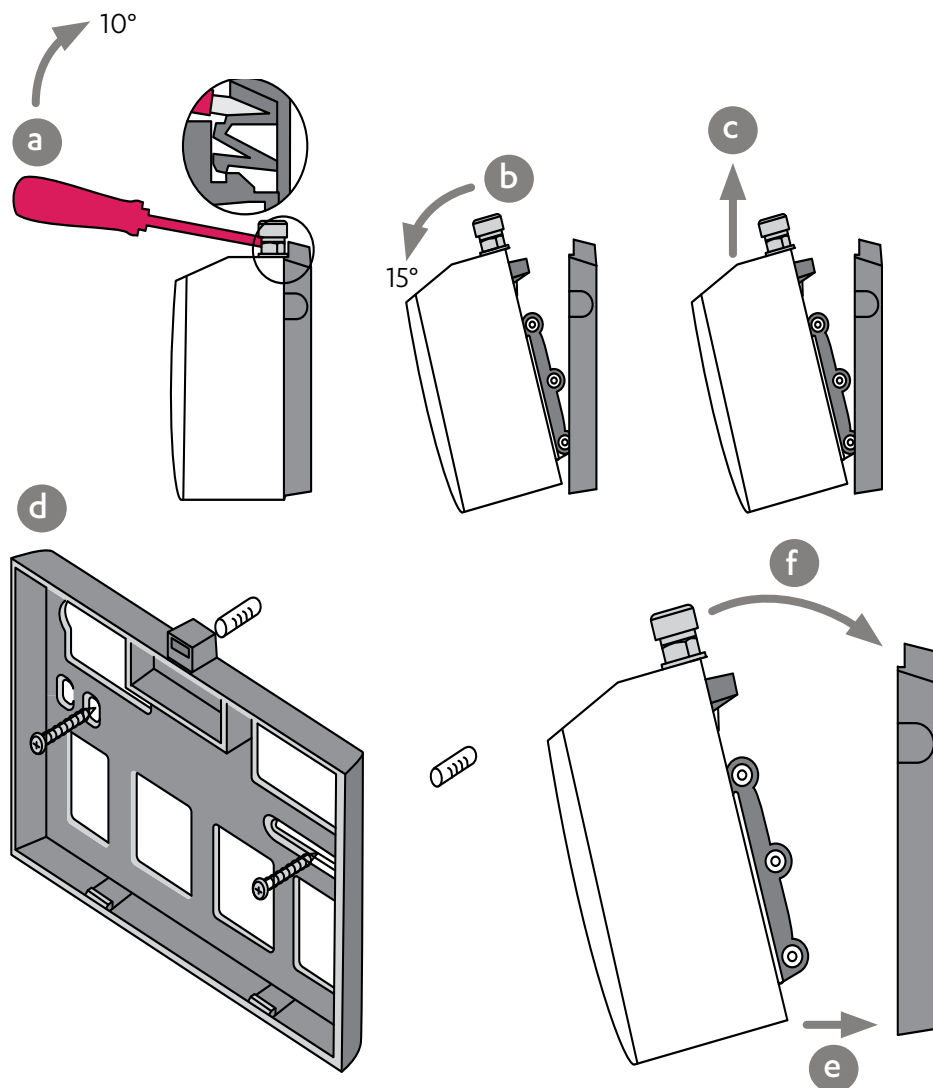

Note 1 This appliance is intended for use with the Zenith HydroTap G5 Command Centre.

Note 2 Water connections must be pointing vertically upwards.

Note 3 The booster unit should be installed as close as possible to the Zenith HydroTap G5 as the connection hoses cannot be lengthened.

3.6.4 Braided hose connections

- The cold water inlet (blue cap) and hot water outlet (red cap) are marked on the rating plate. Connect the braided hoses from the 'BYPASS OUT' fitting on the Command Centre to the water inlet of the booster (blue cap) and from the outlet of the booster (red cap) to the 'BYPASS IN' fitting on the Command Centre. Avoid exerting mechanical force on the booster. This can be achieved by using a spanner on the flats of the inlet and outlet connections when tightening the braided hose connectors.
- Do not over-tighten ! Tighten the braided hoses by hand, then turn a further 90° to 180° with a spanner.
- Once the water connections have been made, check for any leaks and rectify as necessary.

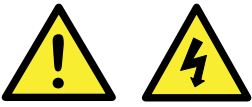

- Do not over tighten hose connections.
- Braided hoses supplied cannot be lengthened.

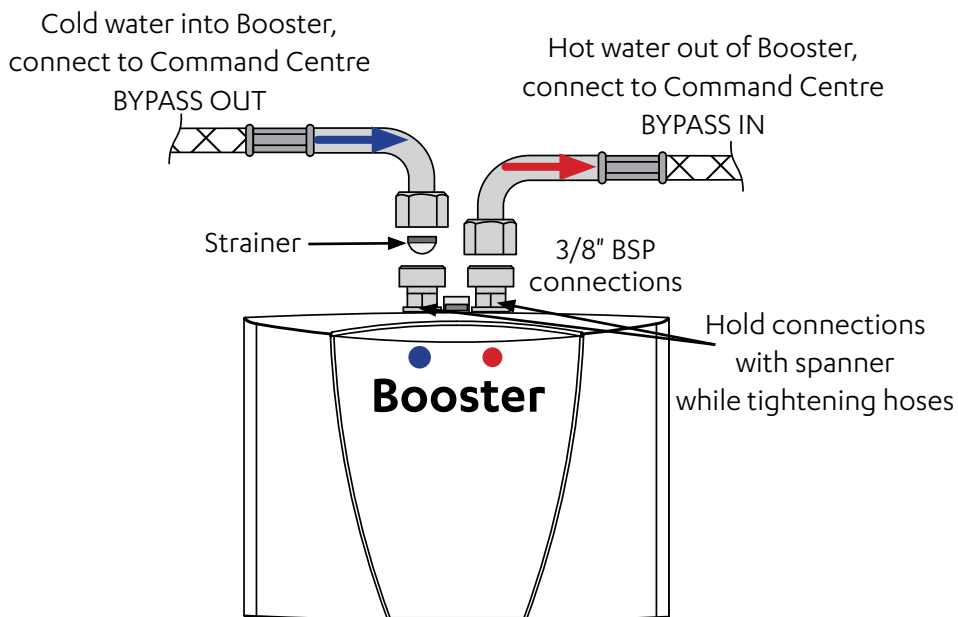



Be aware of the risks of hazards which could cause harm when handling compressed CO₂. Read the safety warnings at the start of this instruction manual. Assess the risks before starting the installation.

3.7.1 Secure the cylinder

- Ensure there is sufficient space to safely secure the cylinder and regulator.

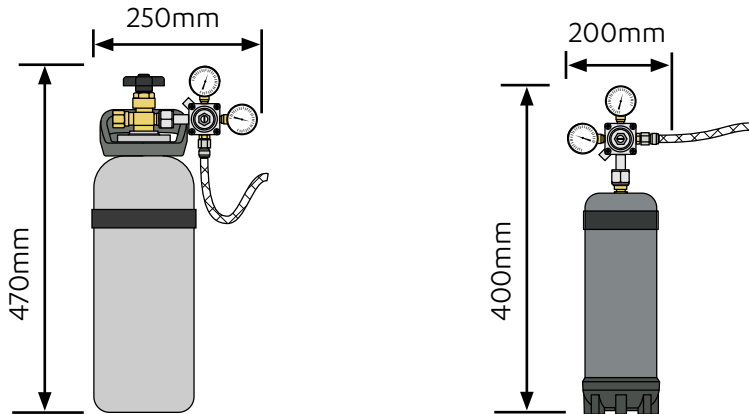

- Secure cylinder vertically to a robust surface with the hook & loop strap and bracket supplied.

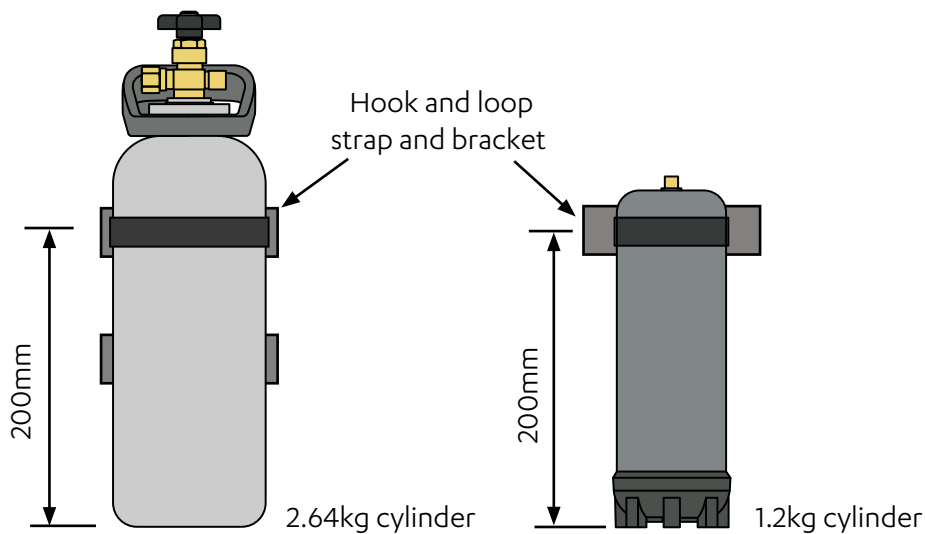

3.7.2 Fit the regulator and connect the gas hose

- Ensure all mating surfaces are clean.
- Turn the regulator OFF, (fully anticlockwise).
- Check the regulator and hose seals, inside the connectors.
- Carefully screw the regulator onto the cylinder connection.
- For the 1.2kg cylinder use the adaptor supplied.
- Connect the gas hose to the regulator.
- Connect the gas hose to the Command Centre .



Do not proceed if the seals are damaged.

Take care not to cross thread the regulator , a cross threaded regulator poses a potential hazard.

2.64kg cylinder

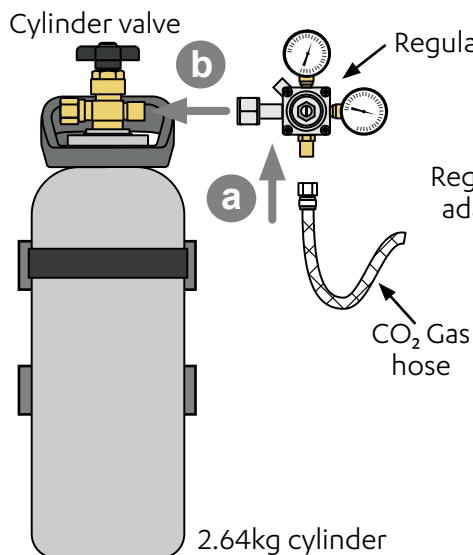

1.2kg cylinder

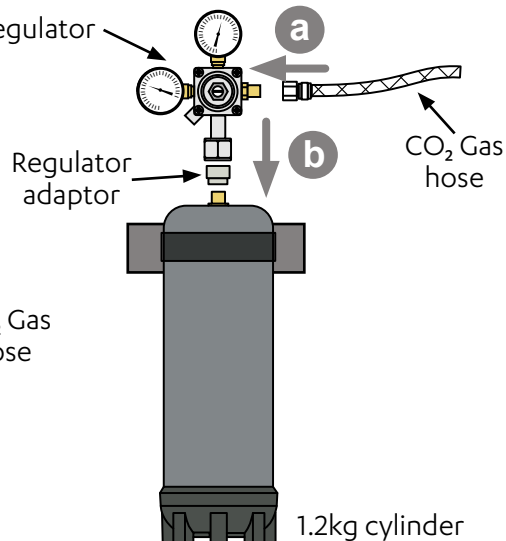

Non-adjustable 1.2kg cylinder regulator

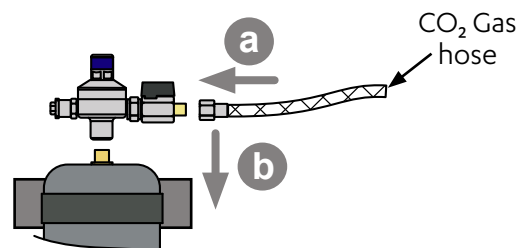

3.7.3 Adjust the Universal G5 regulator

- Check the regulator is turned all the way OFF (anti-clockwise).
- Turn the gas ON using the cylinder valve, (anti-clockwise). (dual-gauge regulator).
- Turn the regulator control knob (clockwise +) to adjust the outlet pressure to 3.0 bar on the outlet pressure gauge.

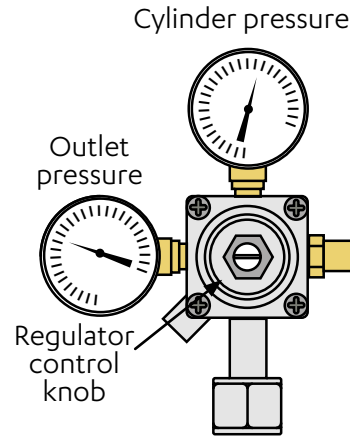

3.7.4 1.2kg cylinder Non-adjustable regulator

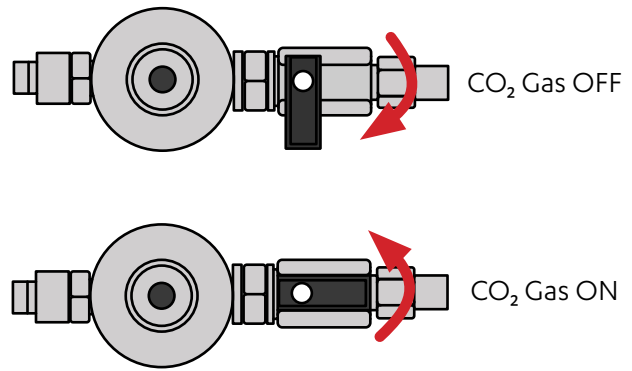
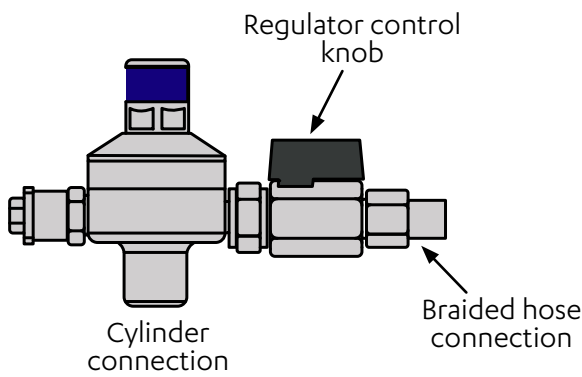

3.7.5 Test for leaks



Care must be taken when working with high pressure carbon dioxide, and in no case should the normal operating pressure of 3.0 bar be exceeded.

- Apply soapy water to the gas connections (see below), using a sponge or brush.
- If there is a leak, bubbles will appear. In the case of a leak, turn OFF the gas, clean away the soapy residue and re-seal the leaking connection.

● Test for leaks in these areas

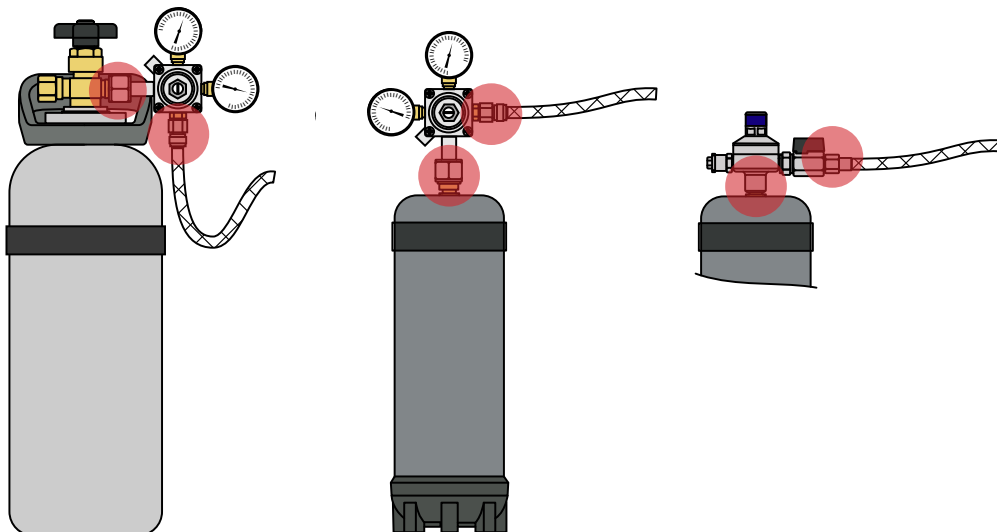

Using these instructions

Please refer to all safety and installation requirements detailed at the start of this installation manual prior to installation of, or any change to, the complete system.



WARNING



Read the instructions

Before commencing the installation download and read the HydroTap installation instructions.

Font models

There are three font models for the HydroTap, Font, Raised font, and Standalone font, these can be supplied as part of the complete system, but are also available as an optional extra or upgrade, in colours to match the HydroTap.

Font See Section 3.8.1

Compatible HydroTaps

Classic, Classic Plus, Elite Plus, Miniboil, Touch-Free Wave

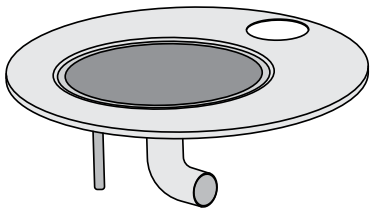

Raised font See Section 3.8.2

Compatible HydroTaps

Classic, Classic Plus, Elite, Elite Plus, Miniboil, Touch-Free Wave

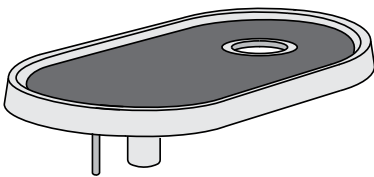

Standalone font See Section 3.8.3

Compatible HydroTaps

Arc, Cube, Classic, Classic Plus, Elite, Elite Plus, Micro, Touch-Free Wave

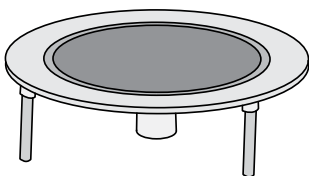

Section 3.8 Font installation

3.8.1 Font installation

Tools needed for Font installation (not supplied)



Be aware of the risks of hazards which could cause harm when using tools. Assess the risks before starting the installation.

In addition to normal tools, the following (or equivalent equipment) will be required.

- 35mm diameter hole saw for tap mounting hole.
- 108mm diameter hole saw for Font mounting hole.
- 13mm diameter drill for drainage point.
- 10mm drill for Font mounting stud clearance holes.
- Tube spanner for fixing the Font assembly.

Parts supplied in the kit

Qty	Description
1	Font body, detachable Font grille & extension piece
1	Mounting nut and washer
1	Stud extension & link nut
1	Pipe branch attachment
2	Worm drive clamps for pipe branch attachment
2	Worm drive clamps for flexible drain hose
3	Clear silicone tubes and stainless steel tube adaptors (135mm tap extension kits)
1	Transparent film template (part no. 89760)
1	Drain hose PVC 19mm ID

Positioning



Ensure that Font is positioned to minimise the risks of scalding by dispensing boiling water while using the tap.

- Position Tap and Font using the template provided.
- Position Command Centre and Tap as close together as possible.

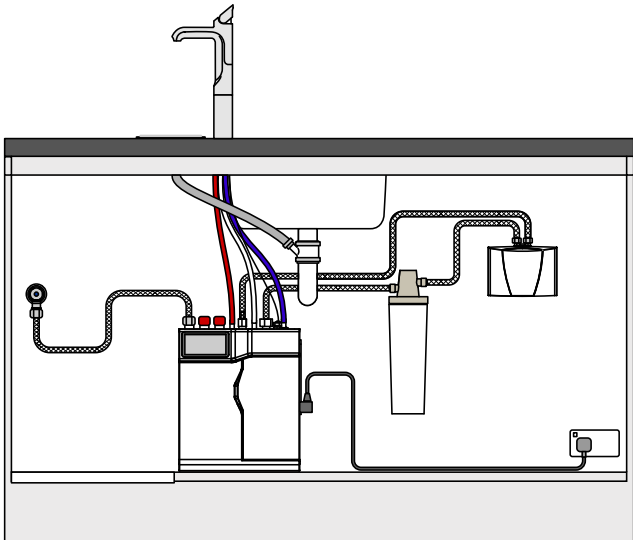

Mark out the Font position



Refer to HydroTap installation instructions

- Place the transparent film template (supplied) in position on the work surface.
- Mark out the hole positions and centres.

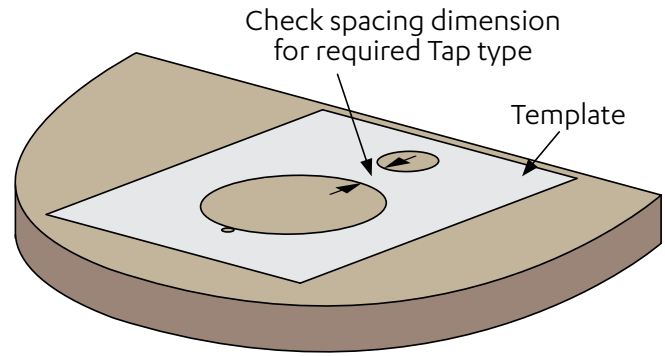

Cut the holes

- 108mm diameter clearance for Font bowl.
- 10mm diameter clearance for mounting stud.
- 35mm diameter tap clearance hole.

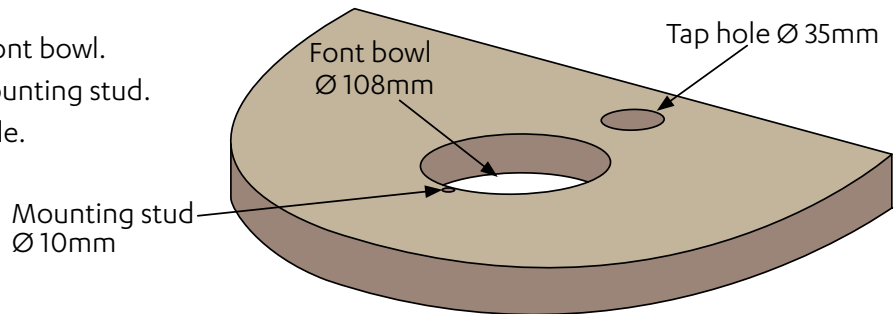

Mount the font

- Remove the spider clamp, fixing nut, fixing washer and black plastic spacer from the Tap assembly.



Refer to the installation instructions supplied with the HydroTap for identification

- If required, extend the water tubes from the Tap using silicone and metal tubes, as shown.
- Connect the extension stud to the Tap with the link nut, as shown.
- Apply light film of silicone sealant around the Font Tap hole.
- Clip the black plastic spacer and base ring together on either side of the Font Tap hole.
- Feed the Tap pipes, stud, and cable through the extension, Font & Tap holes.
- Apply silicone sealant to Font rim.
- Press Tap & Font into position.
- Align Tap spout centrally on the Font.

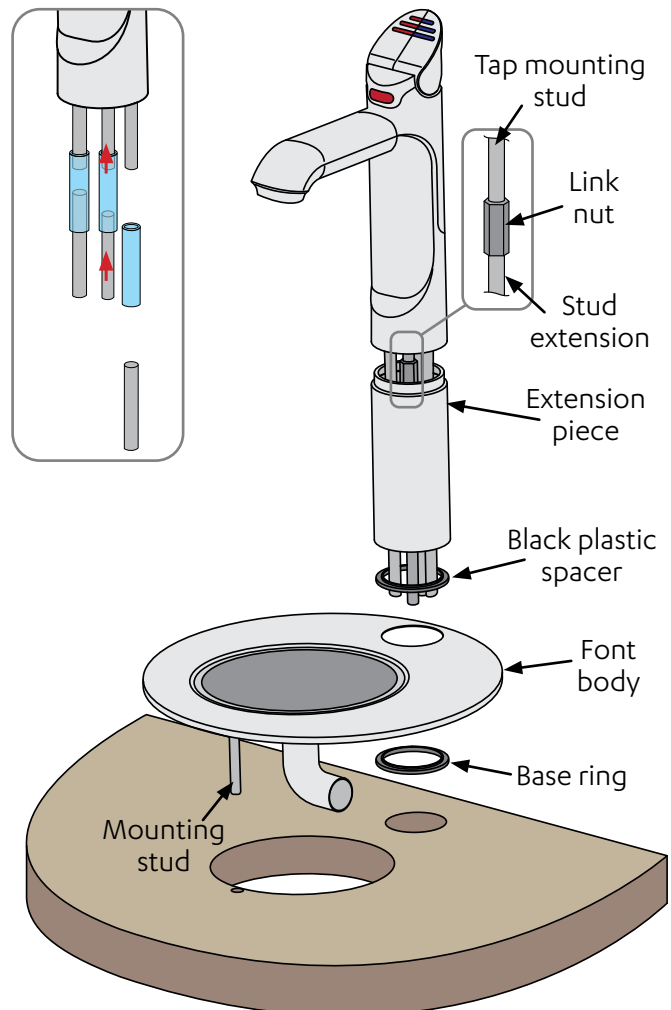

Section 3.8 Font installation

Secure Font & Tap, attach drain (underneath)

- Secure Font with mounting nut and washer.
- Secure Tap with spider clamp, fixing nut and washer.
- Secure flexible drain pipe with a worm drive clamp.
- Ensure braided clear reinforced tubing is used.
- If required, use the elbow fitting (supplied) under the Font to prevent hose kinks.
- Maximum tube length should not exceed 1 metre.

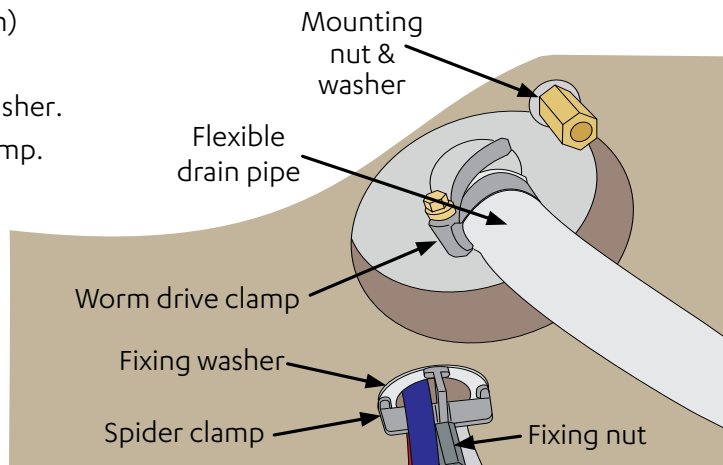

Prepare the drainage point



**Position upstream of a drain trap.
 Drain pipe must have a constant fall.
 Ensure there are no kinks or sags.**

- Locate pipe branch attachment temporarily in position on vertical pipe, upstream from a drain trap.
- Mark spigot hole position, remove attachment & drill out 13mm diameter.
- Apply sealant to spigot groove.
- Ensuring spigot is pointing upwards, snap attachment into place over hole.
- Ensure excess silicone is cleared at drain entry before final hose connection.
- Secure with worm drive clamps.
- Attach drain pipe to spigot.
- Secure with worm drive clamp.

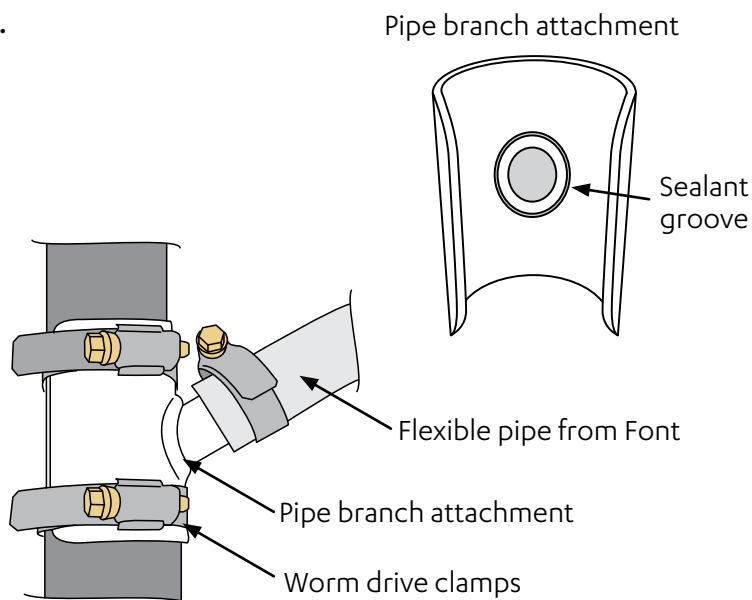

Test for leaks

● Test for leaks here, re-seal if required.

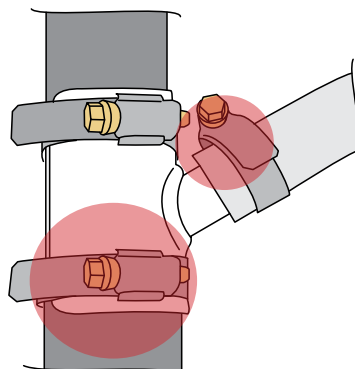
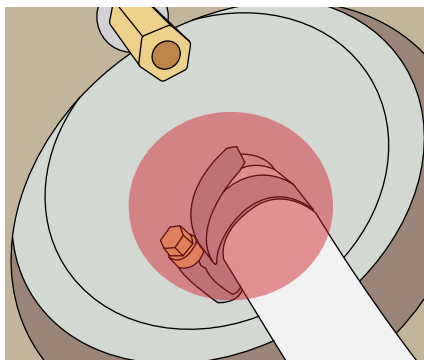

Cleaning and general maintenance

Wipe surfaces with a damp cloth and then wipe dry with a clean, dry cloth. Do not use disinfectant sprays without wiping dry afterwards.

Note If you are experiencing drain-away issues after correct installation, you can consider installing an AAV (Air Admittance Valve) in accordance with your local plumbing code.

Section 3.8 Font installation

3.8.2 Raised Font installation

Tools needed for Font installation (not supplied)



Be aware of the risks of hazards which could cause harm when using tools. Assess the risks before starting the installation.

In addition to normal tools, the following (or equivalent equipment) will be required.

- 35mm diameter hole saw for tap mounting hole.
- 86mm diameter hole saw for Font mounting hole.
- 13mm diameter drill for drainage point.
- 10mm drill for Font mounting stud clearance hole.
- Tube spanner 6mm (supplied).

Parts supplied in the kit

Qty	Description
1	Font body, detachable Font grille & extension piece
1	Mounting stud, nut and washer
1	Extension & link nut
3	Clear silicone tubes and stainless steel tube adaptors (135mm tap extension kits)
1	Pipe branch attachment
2	Worm drive clamps for pipe branch attachment
2	Worm drive clamps for flexible drain hose
1	Benchtop cutting template (part no. 809249)
1	Tube spanner
1	Elbow fitting for drain inc. 2 worm drive clamps
1	Drain hose PVC 19mm ID

Positioning



Ensure that Font is positioned to minimise the risks of scalding by dispensing boiling water while using the tap.

- Position Tap and Font using the template provided.
- Position Command Centre and Tap as close together as possible.

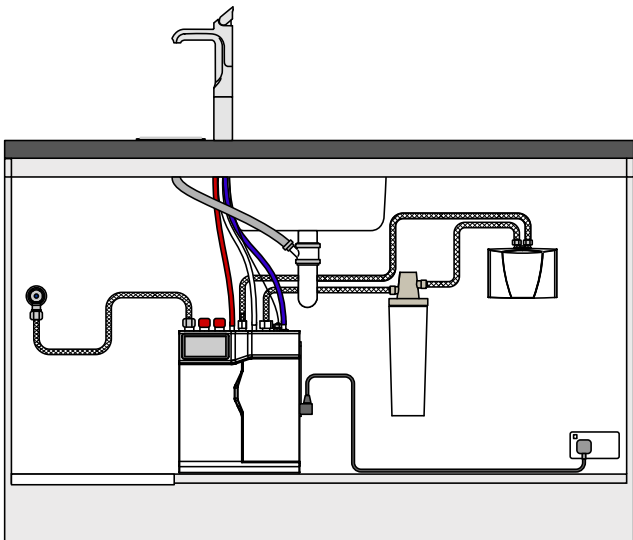

Mark out the Font and Tap positions



Refer to the installation instructions supplied with the HydroTap for its installation

- Place the transparent film template (supplied) in position on the work surface.
- Mark out the hole positions and centres.

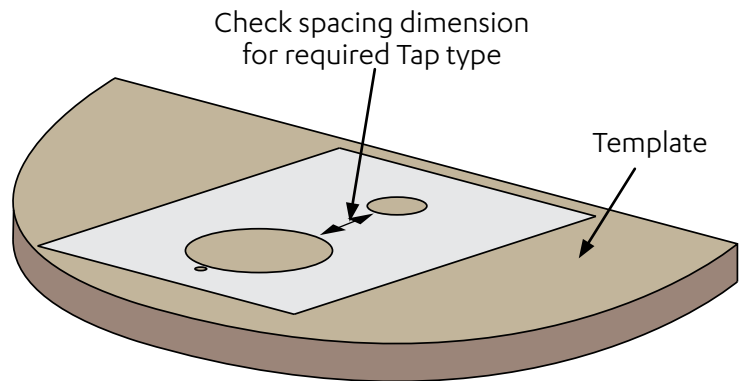

Cut the holes

- 86mm diameter clearance for Font bowl.
- 10mm diameter clearance for mounting stud.
- 35mm diameter Tap clearance hole.

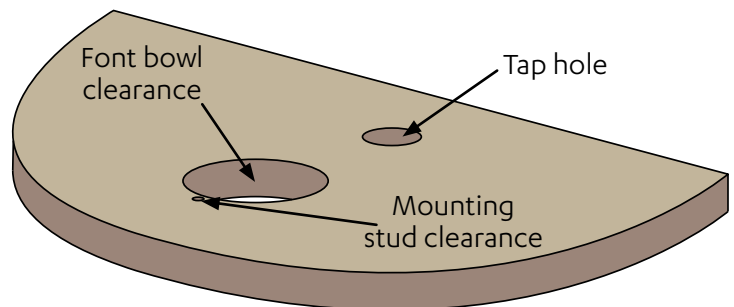

Mount the font

- Remove the spider clamp, fixing nut, fixing washer and black plastic spacer from the Tap assembly. Use tube spanner supplied



Refer to the installation instructions supplied with the HydroTap for identification

- If required, extend the water tubes from the Tap using silicone and metal tubes, as shown.
- Connect the extension stud to the Tap with the link nut as shown adjacent.
- Clip the black plastic spacer onto the bottom of the Tap extension.
- Screw the mounting stud into the Font body.
- Apply a light coat of silicone sealant to the base rim of the Font.
- Feed the Tap pipes, stud, and cable through the extension, Font & Tap holes, and press Tap & Font firmly into position.
- Align Tap spout centrally on the Font.

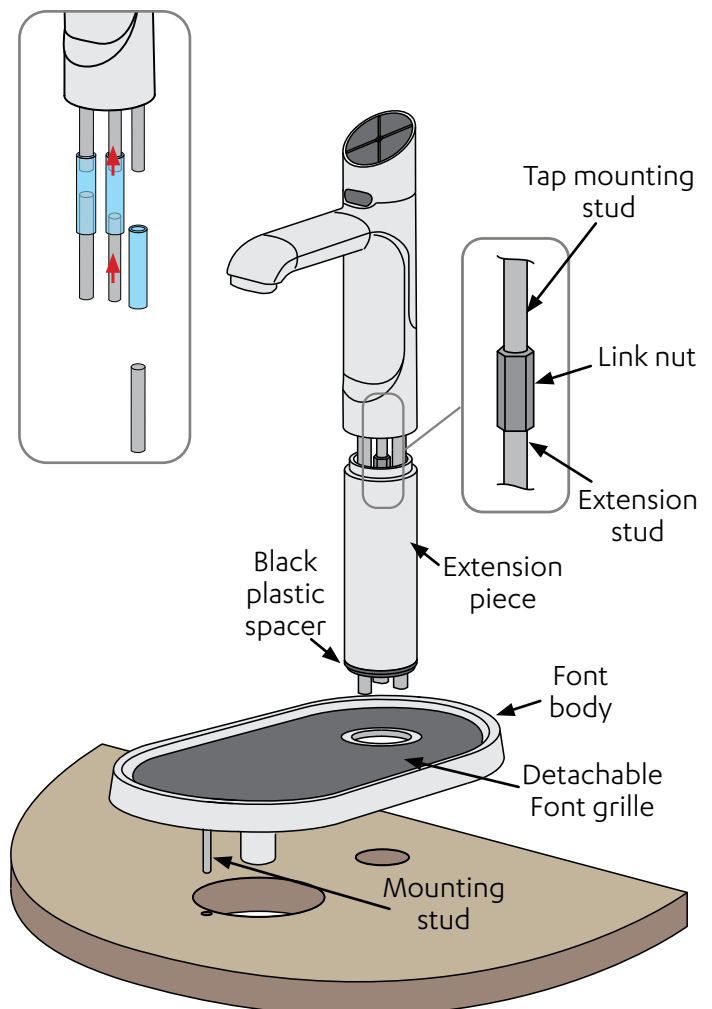

Section 3.8 Font installation

Secure Font & Tap, attach drain (underneath)

- Secure Font with mounting nut and washer.
- Secure Tap with spider clamp, fixing nut and washer.
- Secure flexible drain pipe with a worm drive clamp.
- Ensure braided clear reinforced tubing is used.
- If required, use the elbow fitting (supplied) under the Font to prevent hose kinks.
- Maximum tube length should not exceed 1 metre.

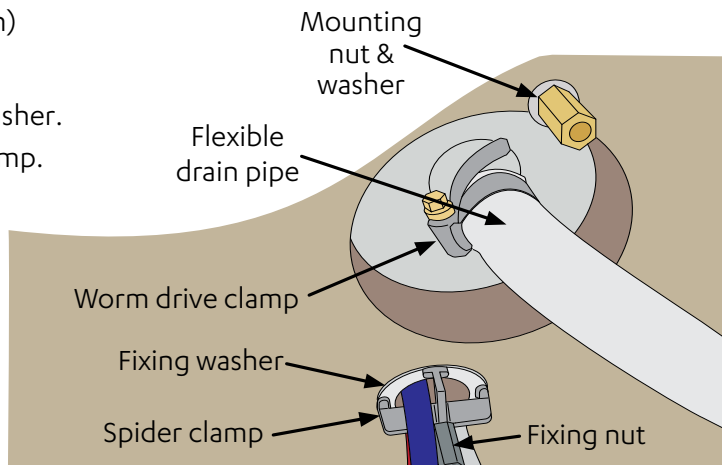

Prepare the drainage point



Position upstream of a drain trap. Drain pipe must have a constant fall.
Ensure there are no kinks or sags.

- Locate pipe branch attachment temporarily in position on vertical pipe, upstream from a drain trap.
- Mark spigot hole position, remove attachment & drill out 13mm diameter.
- Apply sealant to spigot groove.
- Ensuring spigot is pointing upwards, snap attachment into place over hole.
- Ensure excess silicone is cleared at drain entry before final hose connection.
- Secure with worm drive clamps.
- Attach drain pipe to spigot.
- Secure with worm drive clamp.

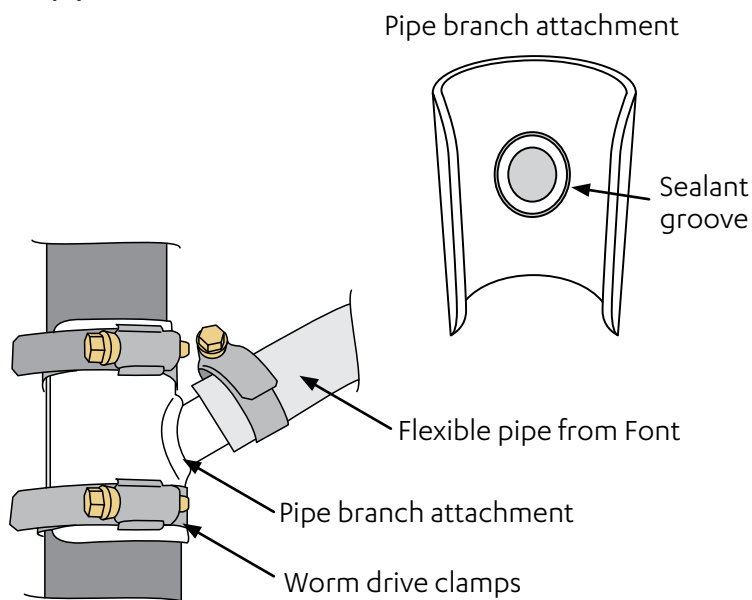

Test for leaks

● Test for leaks here, re-seal if required.

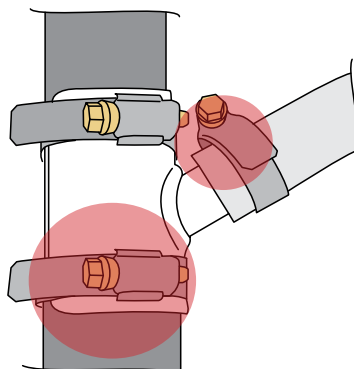
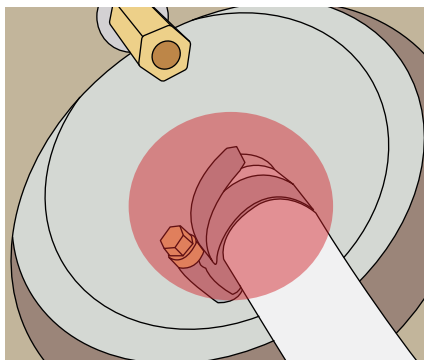

Cleaning and general maintenance

Wipe surfaces with a damp cloth and then wipe dry with a clean, dry cloth. Do not use disinfectant sprays without wiping dry afterwards.

Note If you are experiencing drain-away issues after correct installation, you can consider installing an AAV (Air Admittance Valve) in accordance with your local plumbing code.

Section 3.8 Font installation

3.8.3 Standalone Font installation

Tools needed for Font installation (not supplied)



Be aware of the risks of hazards which could cause harm when using tools. Assess the risks before starting the installation.

In addition to normal tools, the following (or equivalent equipment) will be required.

- 35mm diameter hole saw for tap mounting hole.
- 140mm diameter hole saw for Font mounting hole.
- 13mm diameter drill for drainage point.
- 10mm drill for Font mounting stud clearance holes.
- Tube spanner for fixing the Font assembly.

Parts supplied in the kit

Qty	Description
1	Font body
1	Detachable Font grille
3	Mounting studs
3	Mounting nuts
3	Mounting washers
1	Pipe branch attachment
2	Worm drive clamps for pipe branch attachment
2	Worm drive clamps for flexible drain hose
1	Transparent film template (part no. 806988)
1	Drain hose PVC 19mm ID

Positioning



Ensure that Font is positioned to minimise the risks of scalding by dispensing boiling water while using the tap.

- Position Tap and Font using the template provided.
- Position Command Centre and Tap as close together as possible.

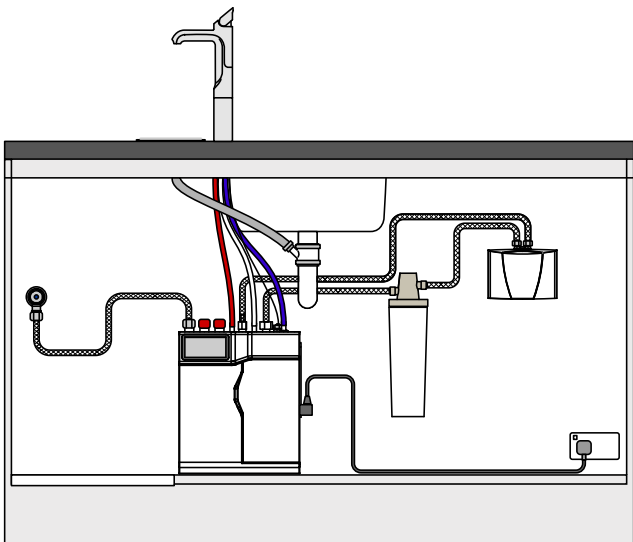

Mark out the font position



Refer to HydroTap installation instructions

- Place the transparent film template (supplied) in position on the work surface.
- Mark out the hole positions and centres.

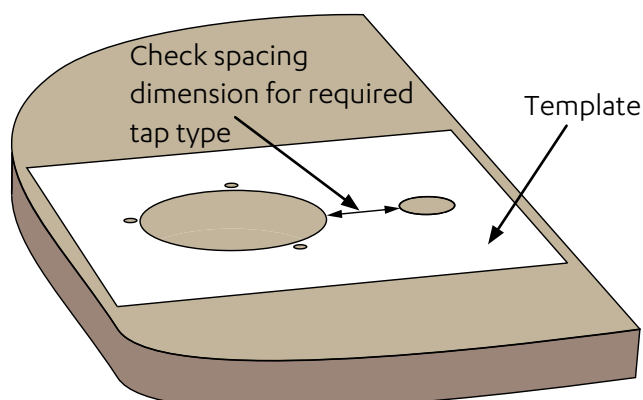

Cut the holes

- 140mm diameter clearance for Font bowl.
- 10mm diameter clearance for mounting studs.
- 35mm diameter tap clearance hole.

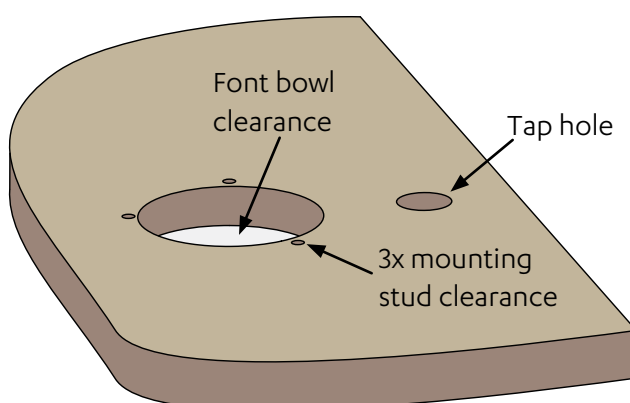

Mount the font



Refer to HydroTap installation instructions

- Apply a light coat of silicone sealant to underside of Font rim, to seal to work surface.
- Screw mounting studs into font flange bosses.
- Locate Font & and lightly press into position.
- (Ensure that the HydroTap is positioned such that it dispensed into the centre of the font).

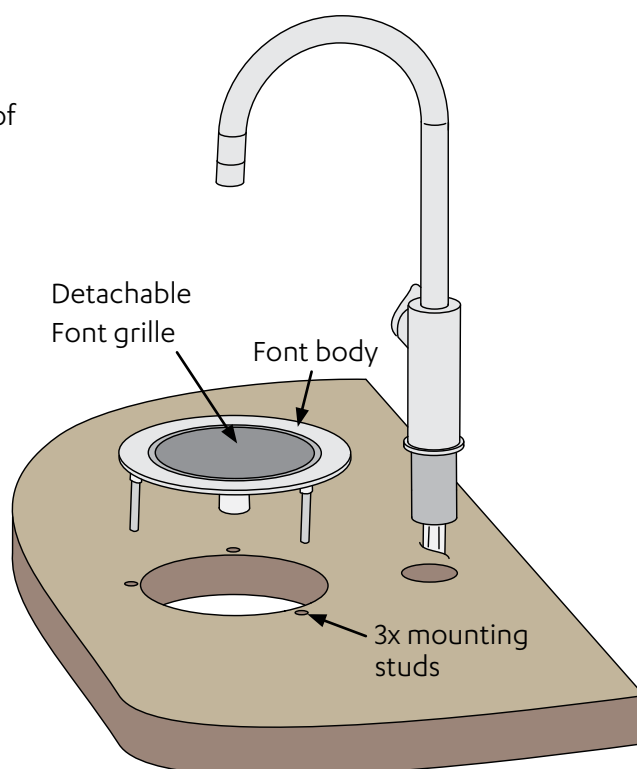

Secure the Font & attach the pipe (underneath)

- Secure the Font with mounting nuts and washers.
- Secure flexible drain pipe with a worm drive clamp. Ensure braided clear reinforced tubing is used.
- If required, use the elbow fitting (supplied) under the Font to prevent hose kinks.
- Maximum tube length should not exceed 1 metre.

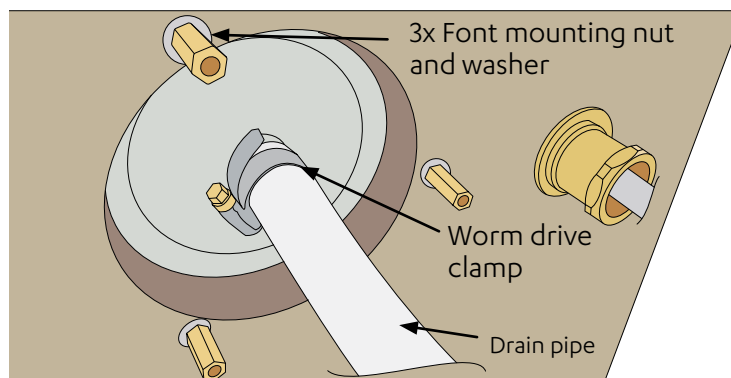
**Prepare the drainage point**

**Position upstream of a drain trap.
Drain pipe must have a constant fall.
Ensure there are no kinks or sags.**

- Locate pipe branch attachment temporarily in position on vertical pipe, upstream from a drain trap.
- Mark spigot hole position, remove attachment & drill out 13mm diameter.
- Apply sealant to spigot groove.
- Ensuring spigot is pointing upwards, snap attachment into place over hole.
- Ensure excess silicone is cleared at drain entry before final hose connection.
- Secure with worm drive clamps.
- Attach drain pipe to spigot.
- Secure with worm drive clamp.

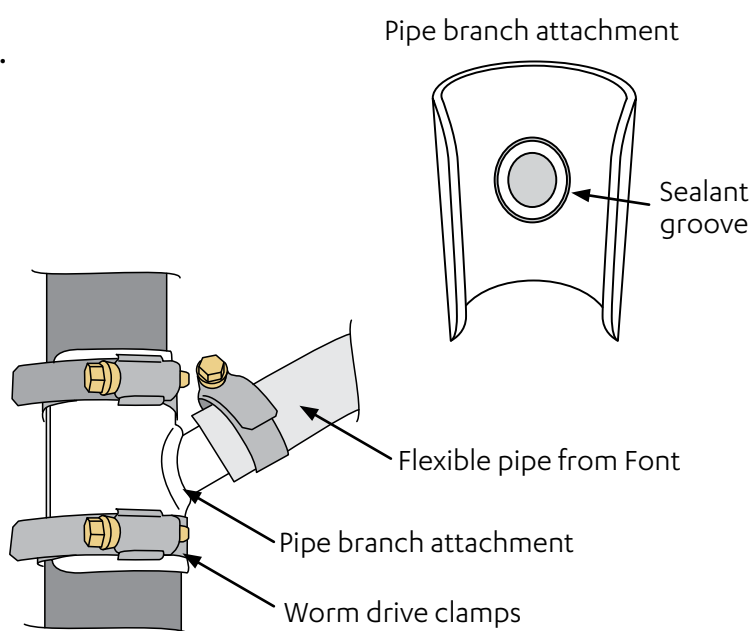
**Test for leaks**

● Test for leaks here, re-seal if required.

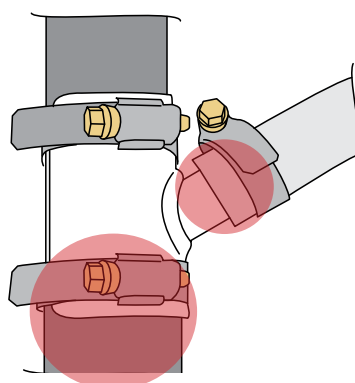
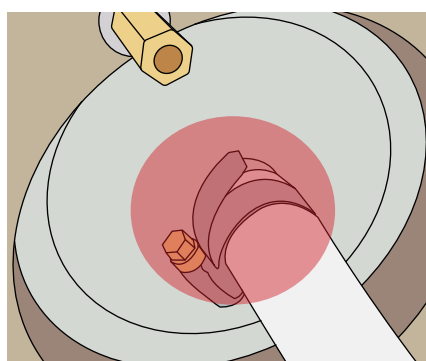
**Cleaning** and general maintenance

Wipe surfaces with a damp cloth and then wipe dry with a clean, dry cloth. Do not use disinfectant sprays without wiping dry afterwards.

Note If you are experiencing drain-away issues after correct installation, you can consider installing an AAV (Air Admittance Valve) in accordance with your local plumbing code.

4.1 Generic installation arrangement instructions



Read these instructions together with those supplied with individual components before commencing Command Centre installation, they apply to all installation arrangements.

- Install the mains water braided hoses to the Command Centre before locating in place. See below.
- Ambient mains water braided hose length is 750mm.
- Electrical power cable is 1.8m long.
- The Command Centre must be installed within the limits of the hose and cable lengths supplied.
- All silicon tubes / plastic pipes must be cut to size. They must have a constant fall back to the Command Centre.
- Isolation valves are not supplied.

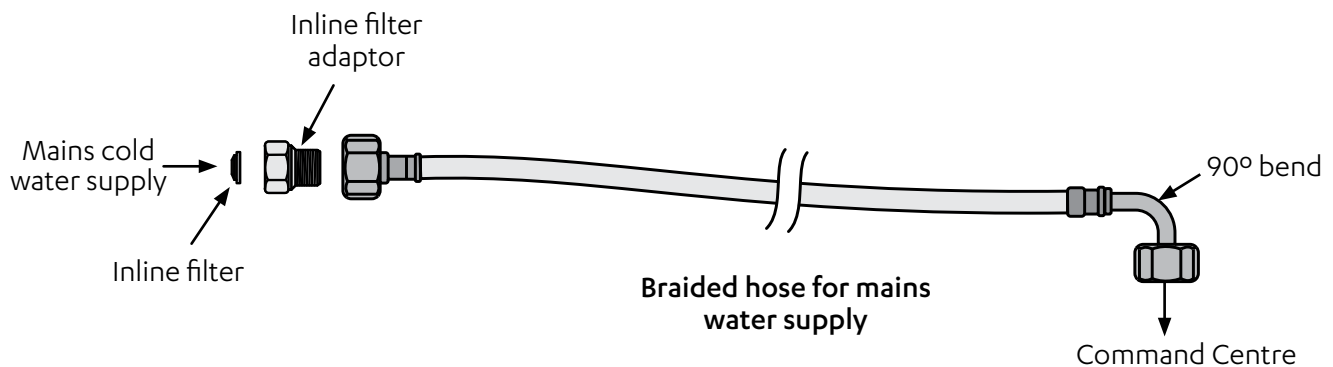

Tubes and pipes

- Take care to install correctly. No kinks, sags, pinches or loops.

Tips for connection

- Push the silicone hose over the connector for a minimum of 15mm.
- Ensure there a constant fall from the tap down to the Command Centre.
- Tubes and pipes must be trimmed to avoid loops and kinks. Take care when positioning before cutting and make a clean cut straight across the hose, using a sharp blade.
- The tubes and pipes must not be under tension when installed.

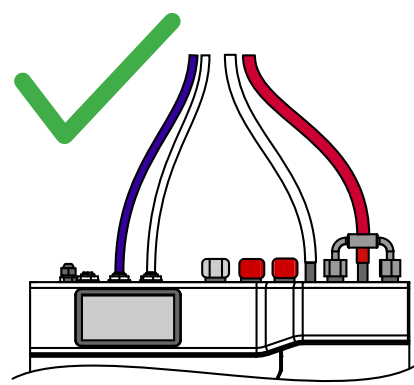
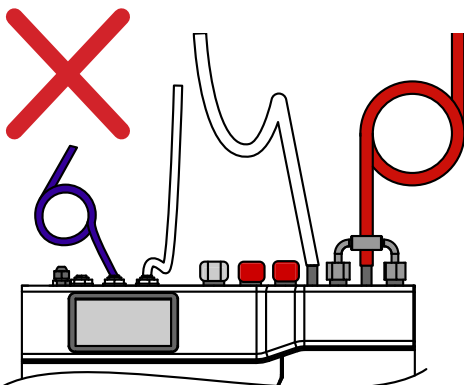

Position of carbonation flow valve (sparkling models)

For optimal Sparkling Water from your HydroTap, follow these directions to position the carbonation flow valve between the HydroTap Command Centre and the dispensing tap.

- Correct positioning and adjustment is essential to good sparkling water performance.
- It is important to position the carbonation flow valve as close to the tap as possible.
- Use the diagrams as a guide.
- For the Celsius AiO Arc, the silicone tubes can be easily deformed, cable-tie the chilled tube assembly to an adjacent braided hose to avoid kinks and loops (as shown).

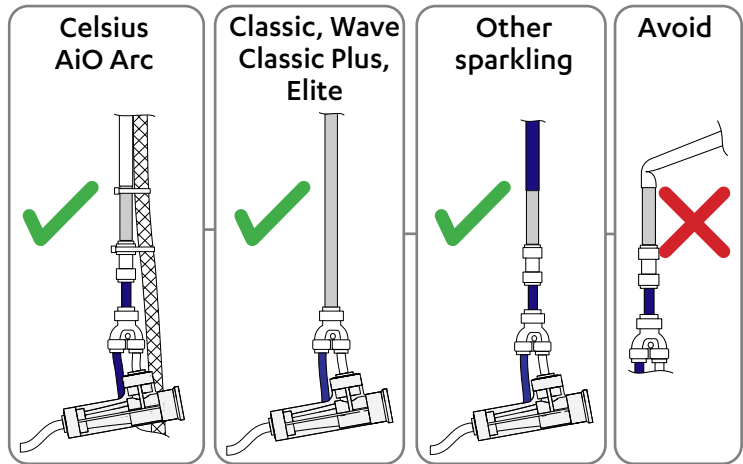

White tube to SPARKLING outlet of Command Centre

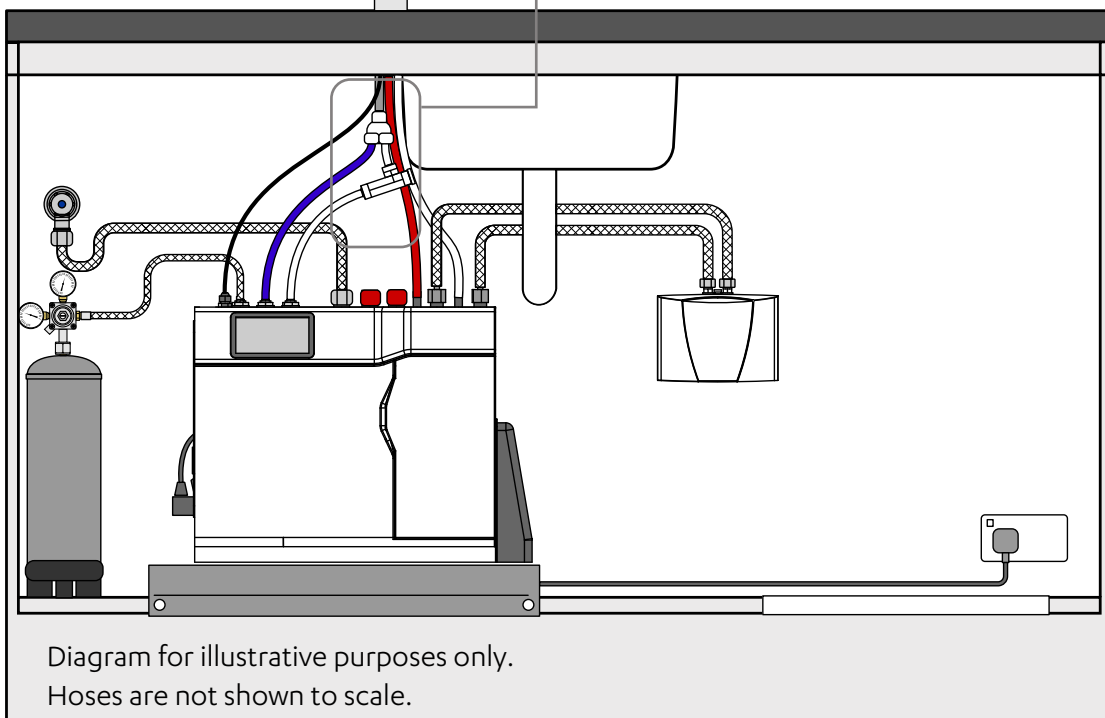

- See page [66](#) for carbonation flow valve adjustment .

John Guest pipe and fittings

Take care to use correctly, see below :

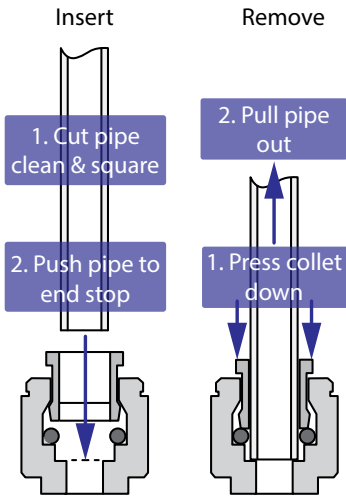

Mains power cable

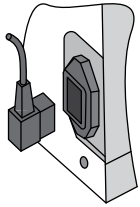

Do not connect to the mains socket until commissioning

USB

Connect Command Centre to HydroTap.

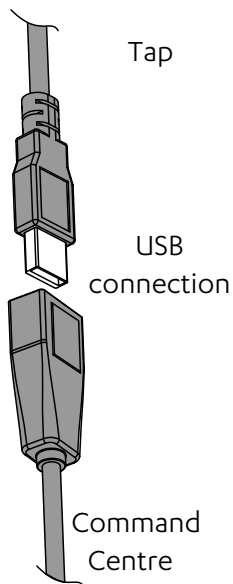
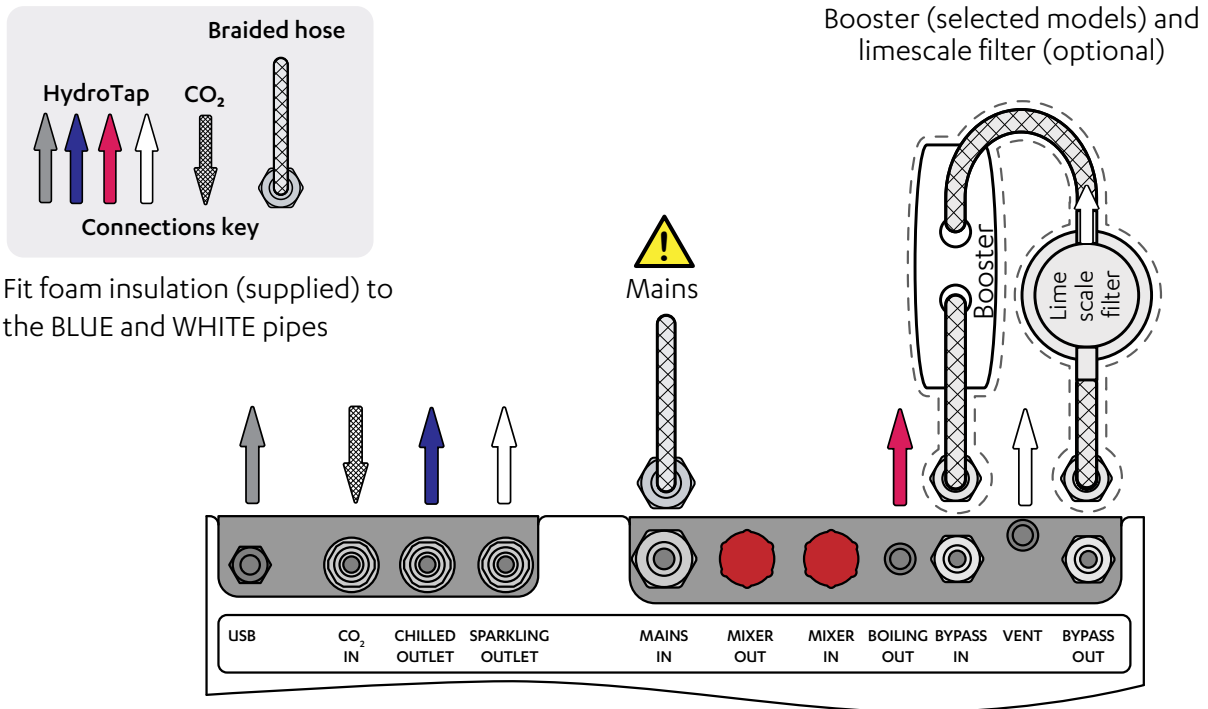

Table of contents

BCS60 - BCS100 commercial installation	
4.2.1 HydroTap G5 models.....	45
4.2.2 HydroTap G5 and vented mixer tap combinations	46
4.2.3 All-in-One MAINS models.....	47
4.2.4 All-in-One VENTED models.....	48
BCS20 - BCS30 commercial and BCS residential installation	
4.3.1 HydroTap G5 models.....	49
4.3.2 HydroTap G5 and vented mixer tap combinations	50
4.3.3 All-in-One MAINS models.....	51
4.3.4 All-in-One VENTED models.....	52
BC40 - BC100 commercial installation	
4.4.1 HydroTap G5 models	53
4.4.2 HydroTap G5 and vented mixer tap combinations.....	54
4.4.3 All-in-One MAINS models	55
4.4.4 All-in-One VENTED models	56
BC20 - BC30 commercial and BC residential installation	
4.5.1 HydroTap G5 models.....	57
4.5.2 HydroTap G5 and and vented mixer tap combinations	58
4.5.3 All-in-One MAINS models.....	59
4.5.4 All-in-One VENTED models.....	60
B60 - B100, BA60 - BA100 and B & BA residential installation	
4.6.1 HydroTap G5 Boiling models.....	61
4.6.2 HydroTap G5 Boiling and Ambient models.....	62
4.6.3 HydroTap G5 Boiling and vented mixer tap combinations	63
4.6.4 HydroTap G5 Boiling and Ambient and vented mixer tap combinations	64
4.6.5 Celsius Boiling models	65
4.6.6 Celsius Boiling and Ambient models	66
CS100 commercial installation	
4.7.1 HydroTap models	67
4.7.2 Celsius models.....	68
C40 - C100 commercial installation	
4.8.1 HydroTap models.....	69
4.8.2 Celsius models	70
CS residential installation	
4.9.1 HydroTap models.....	71
4.9.2 Celsius models	72
C residential installation	
4.10.1 HydroTap models	73
4.10.2 Celsius models.....	74

Section 4 Commercial & Residential Command Centre installation

4.2.1 BCS60 - BCS100 HydroTap G5 models Command Centre connections



Example Installations

Diagram for illustrative purposes only.
 Hoses are not shown to scale, as the booster hoses cannot be lengthened.

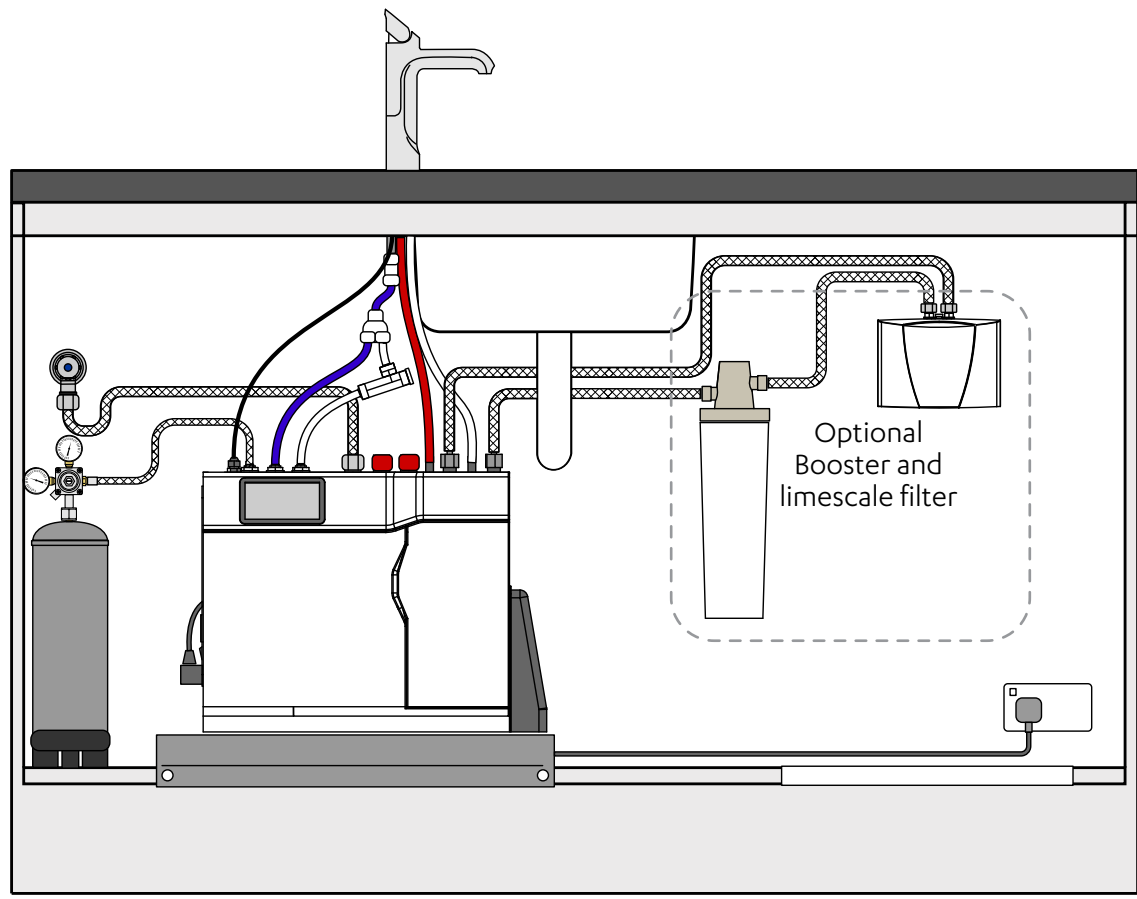

Section 4 Commercial & Residential Command Centre installation

4.2.2 BCS60 - BCS100 HydroTap and mixer tap combinations

Command Centre connections

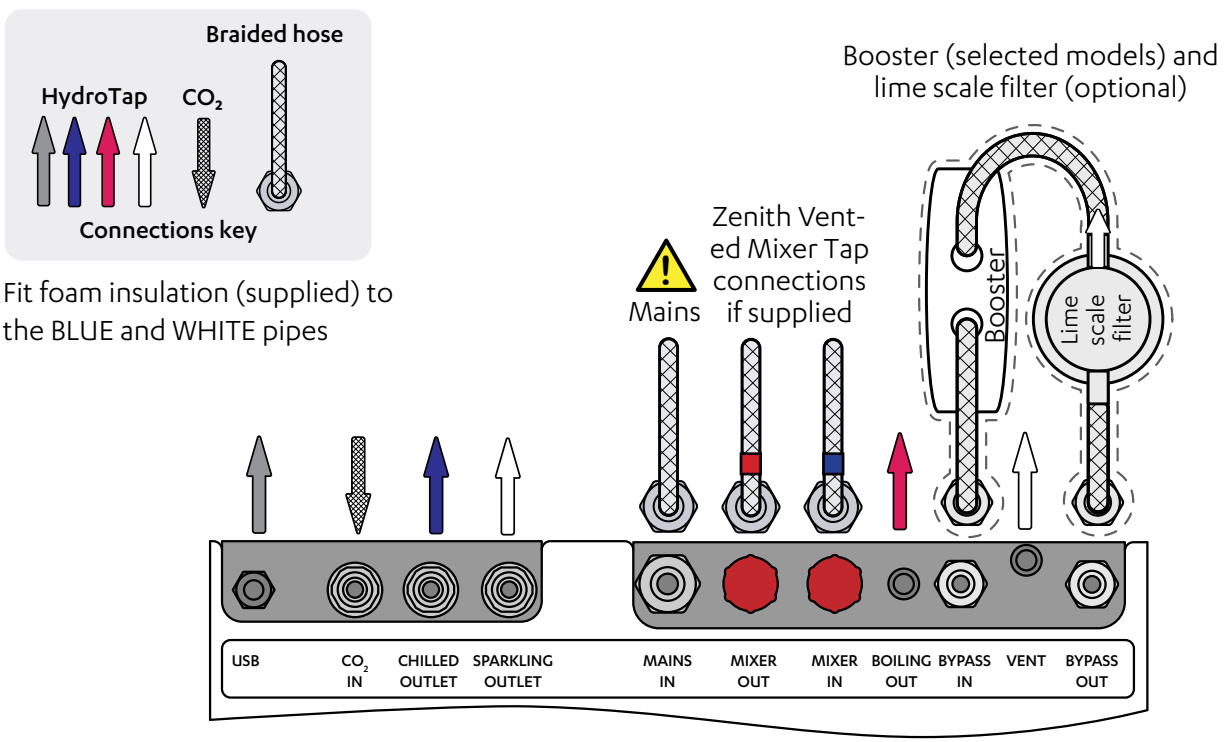

Example Installations

Diagram for illustrative purposes only. Hoses are not shown to scale.

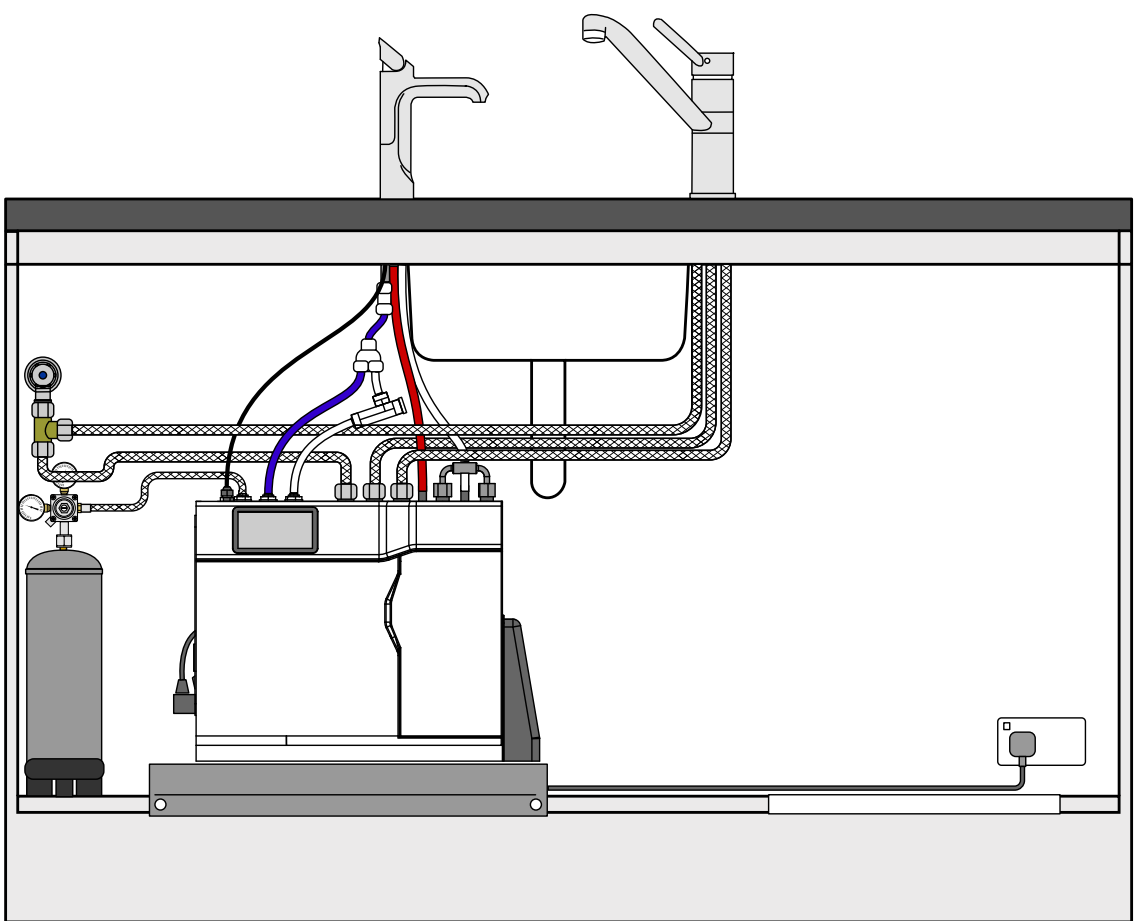

Section 4 Commercial & Residential Command Centre installation

4.2.3 BCS60 - BCS100 All-in-One 'Mains' tap

Command Centre connections

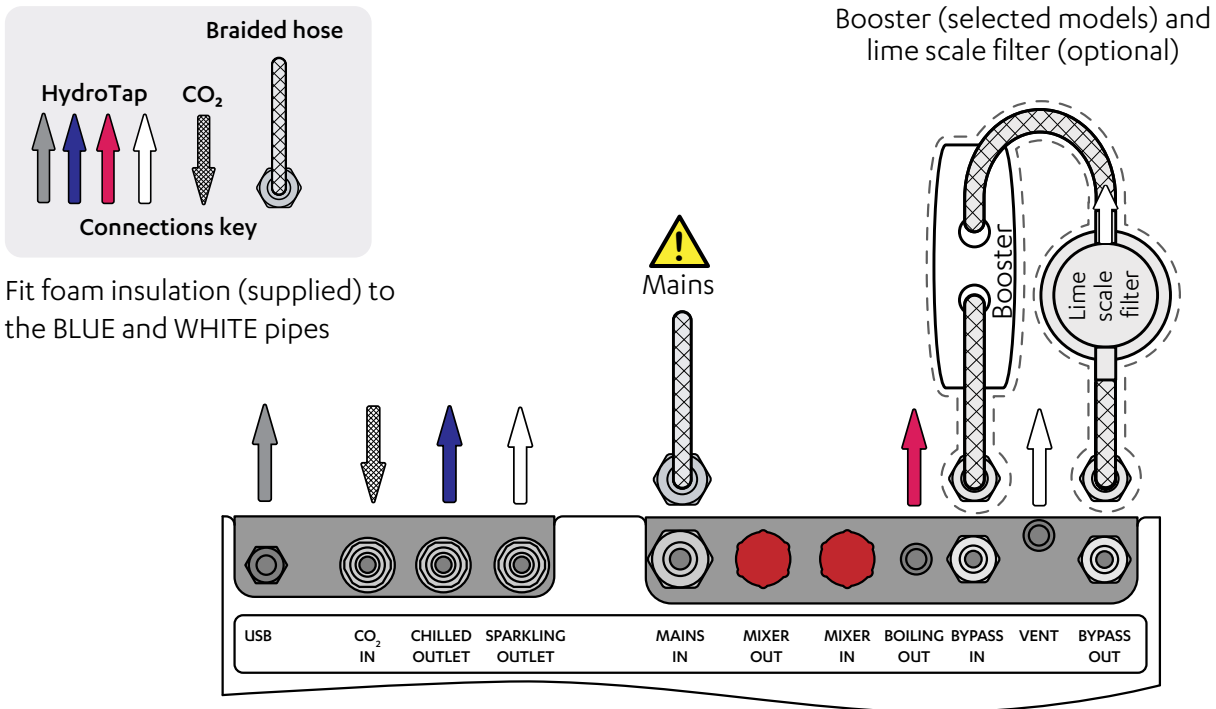

Example Installations

Diagram for illustrative purposes only. Hoses are not shown to scale.

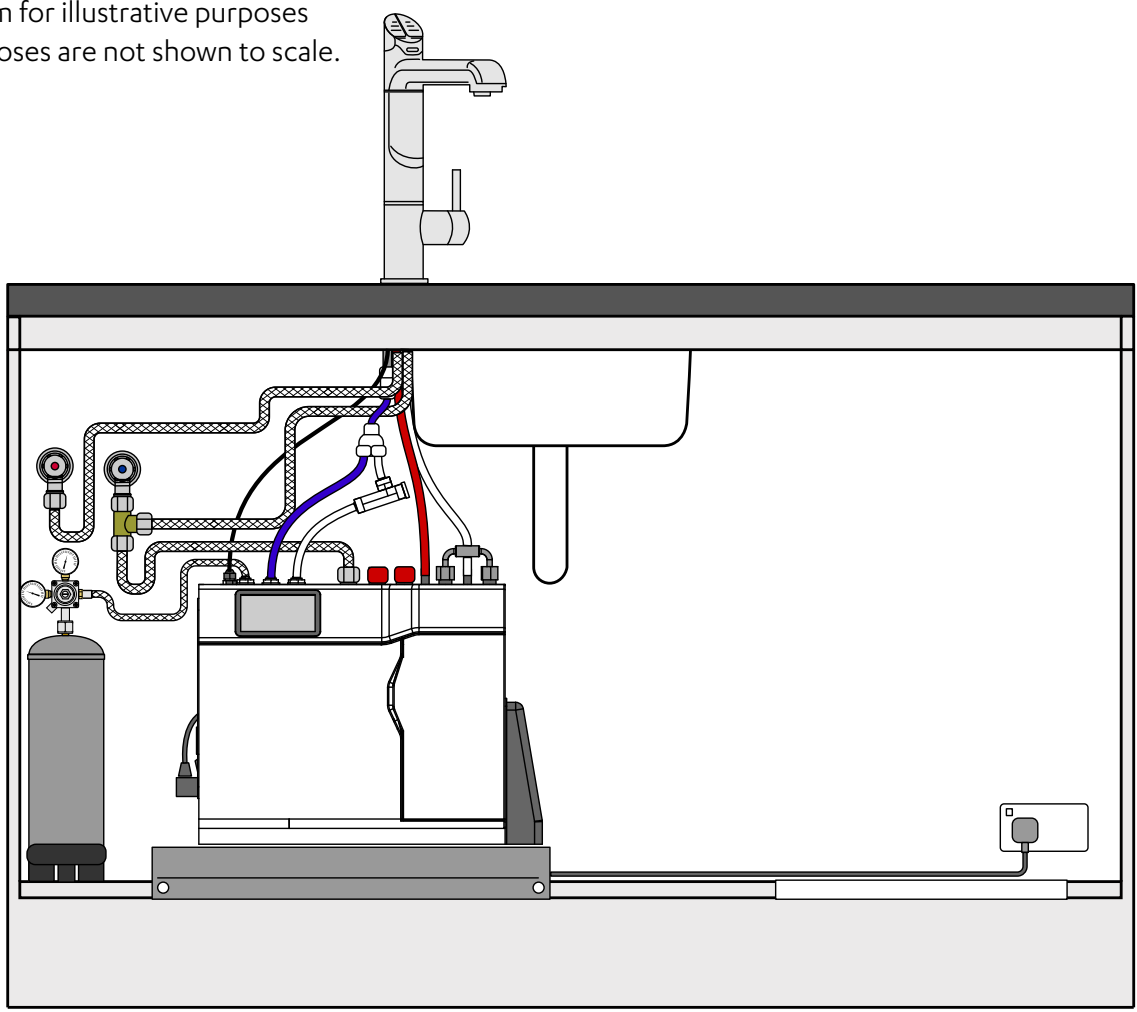

Section 4 Commercial & Residential Command Centre installation

4.2.4 BCS60 - BCS100 All-in-One Classic 'Vented' tap

Command Centre connections

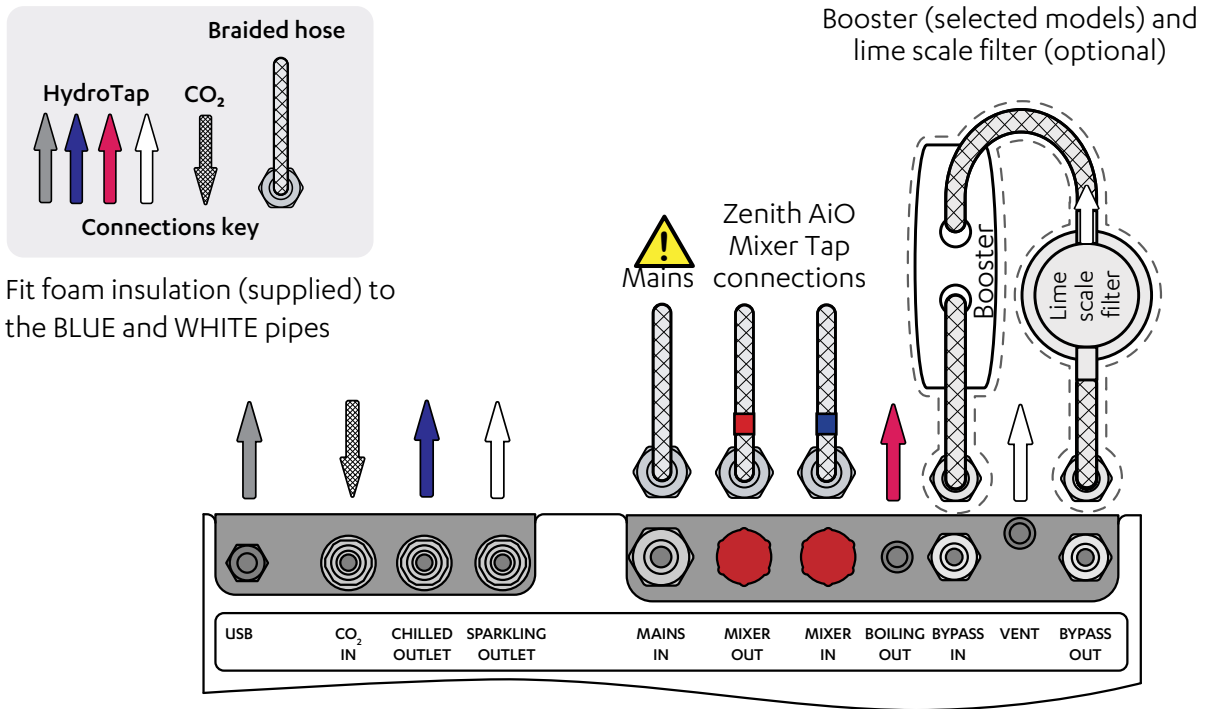

Fit foam insulation (supplied) to the BLUE and WHITE pipes

Example installation

Diagram for illustrative purposes only.
 Hoses are not shown to scale, as the booster hoses cannot be lengthened.

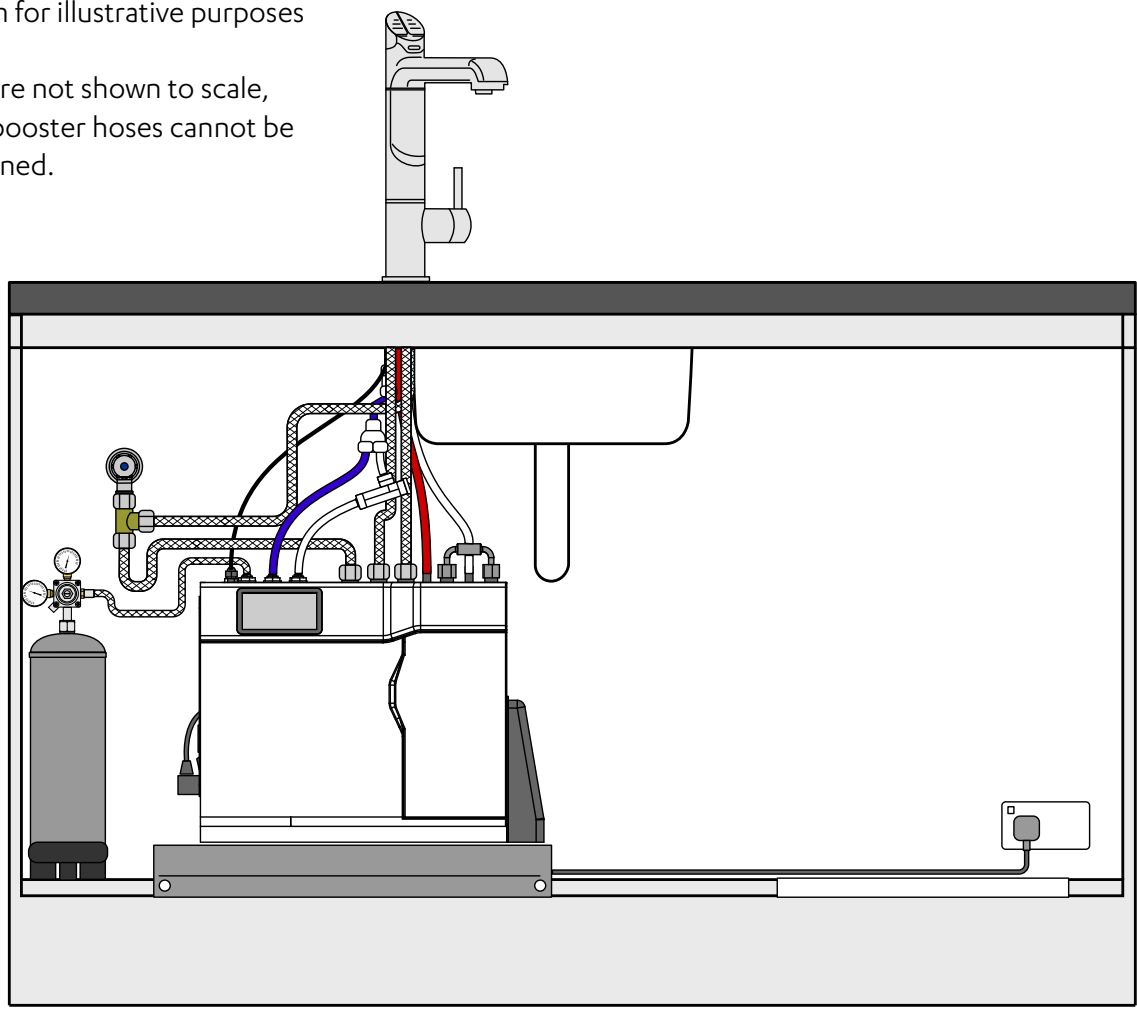

4.3.1 BCS20 - BCS30, BCS Home HydroTap models

Command Centre connections

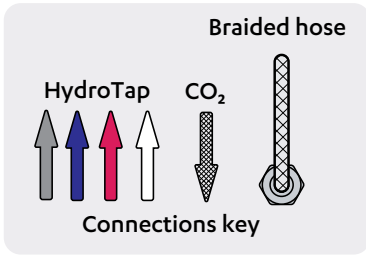

Fit foam insulation (supplied) to the BLUE and WHITE pipes

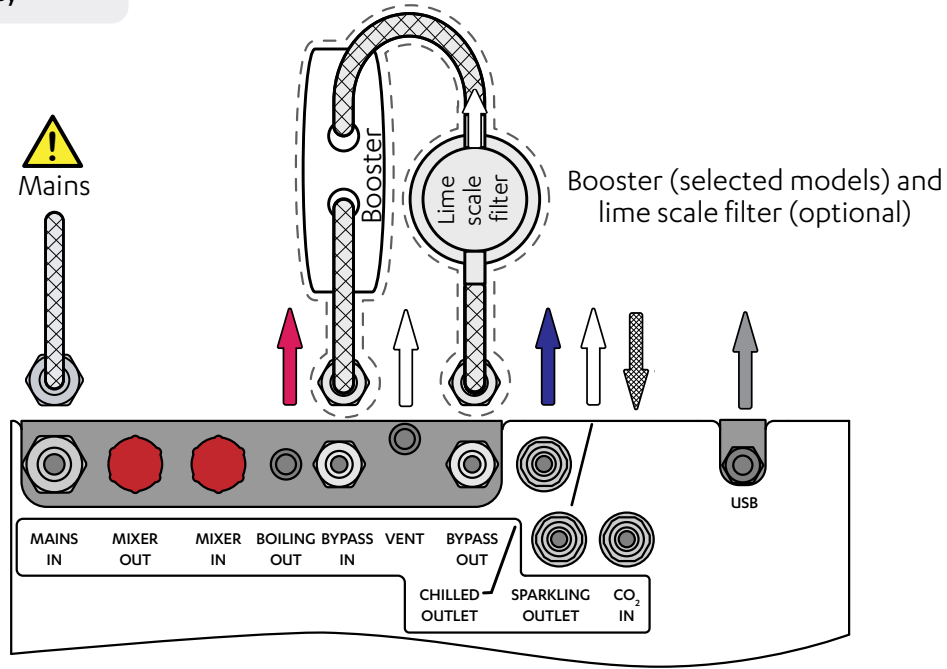

Example installation

Diagram for illustrative purposes only.
Hoses are not shown to scale.

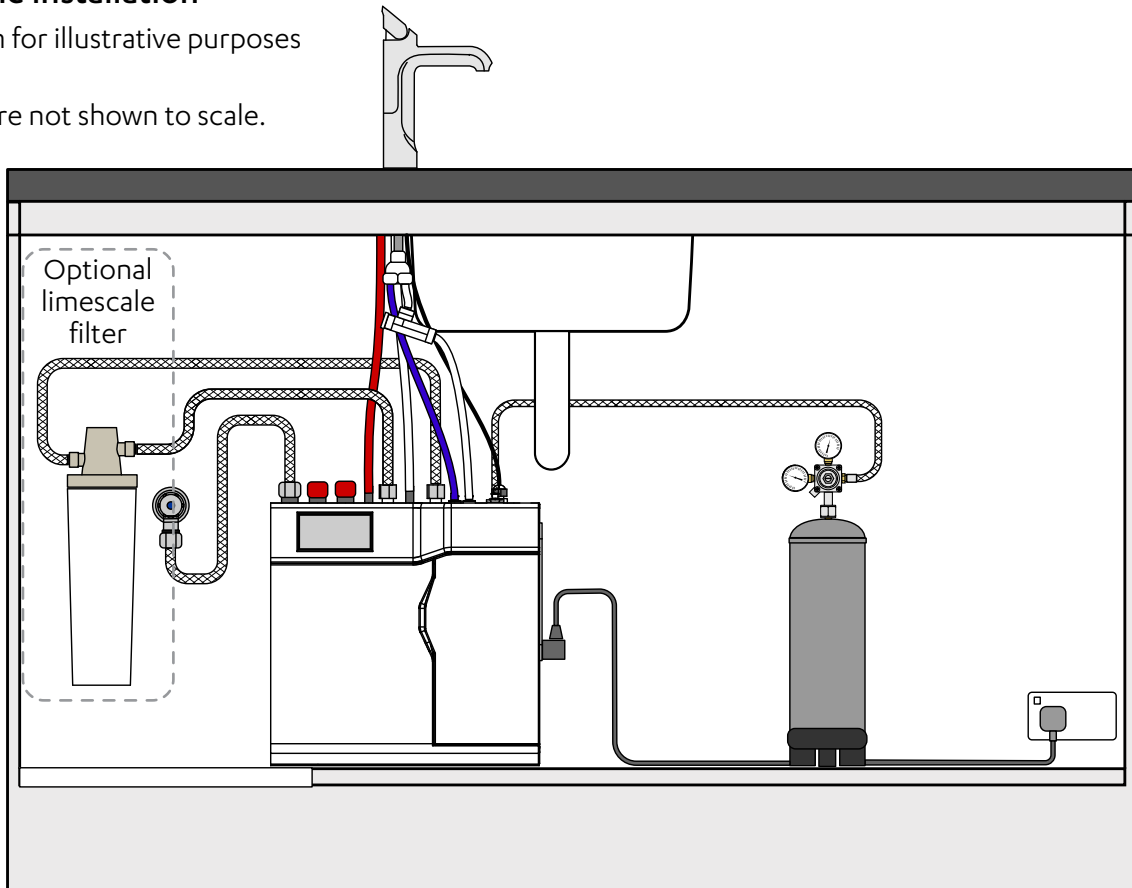

Section 4 Commercial & Residential Command Centre installation

4.3.2 BCS20 - BCS30, BCS Home HydroTap and vented mixer taps

Command Centre connections

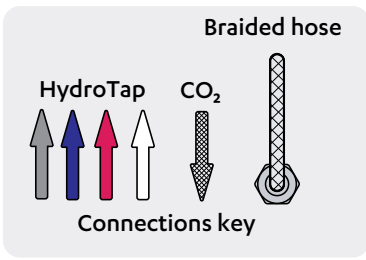

Fit foam insulation (supplied) to the BLUE and WHITE pipes

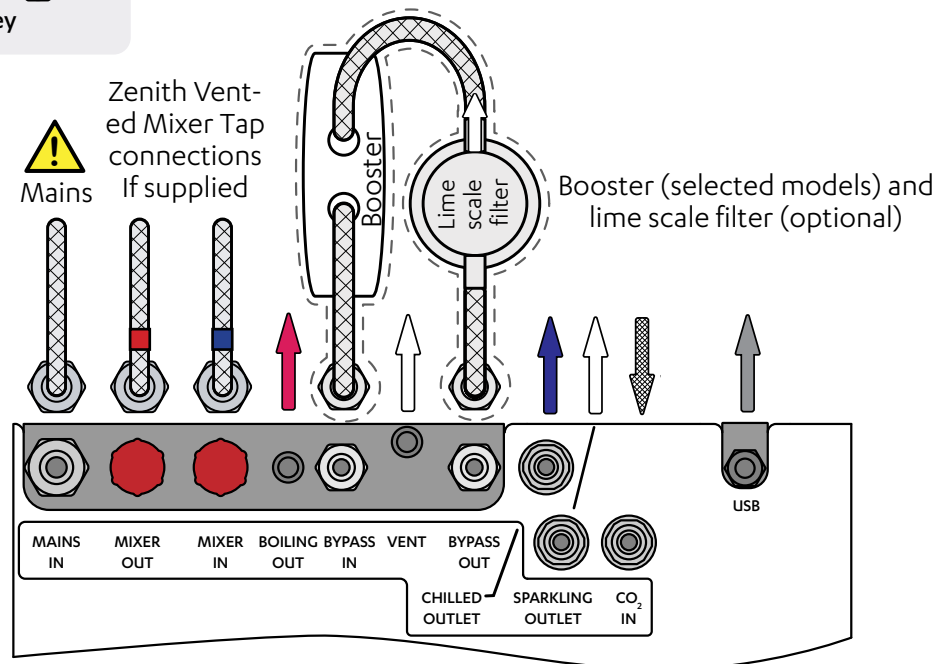

Example installation

Diagram for illustrative purposes only. Hoses are not shown to scale.

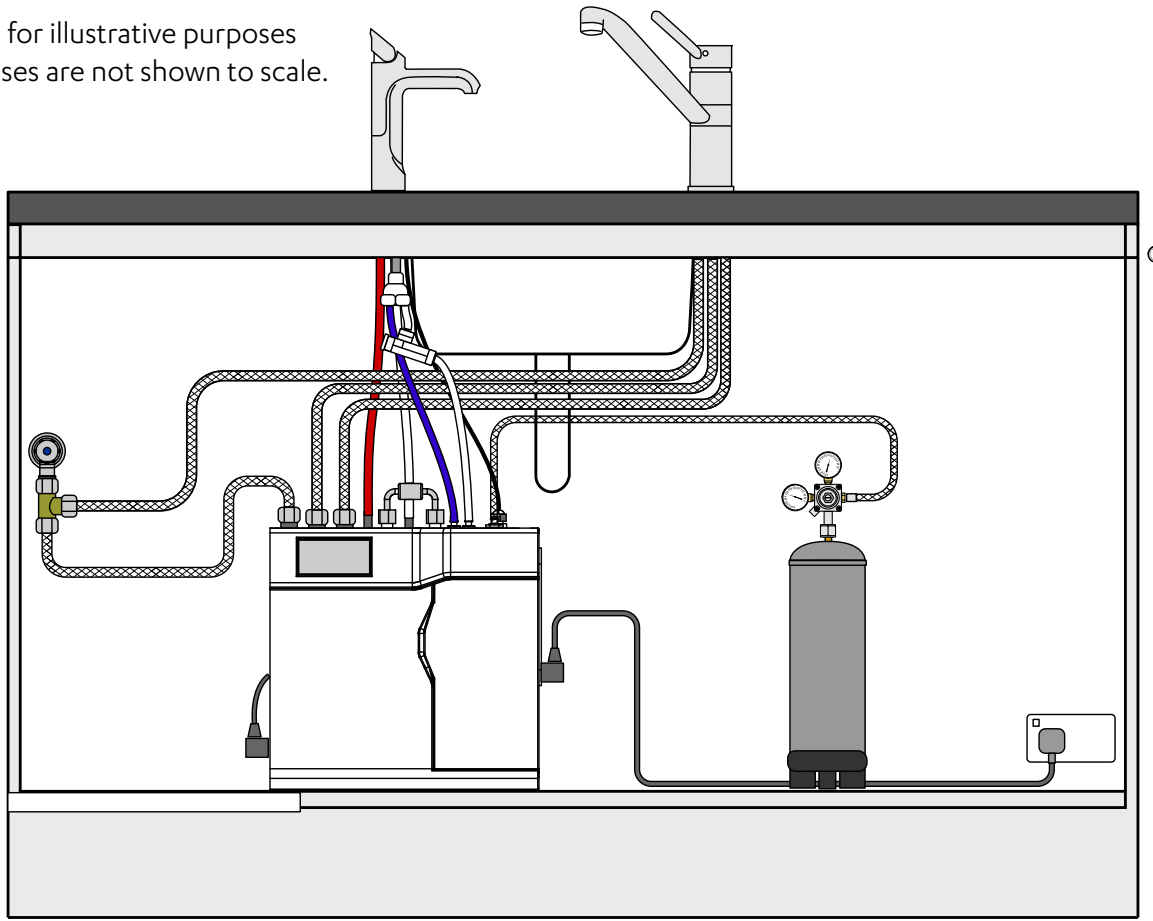

Section 4 Commercial & Residential Command Centre installation

4.3.3 BCS20 - BCS30, BCS Home All-in-One 'Mains' tap Command Centre connections

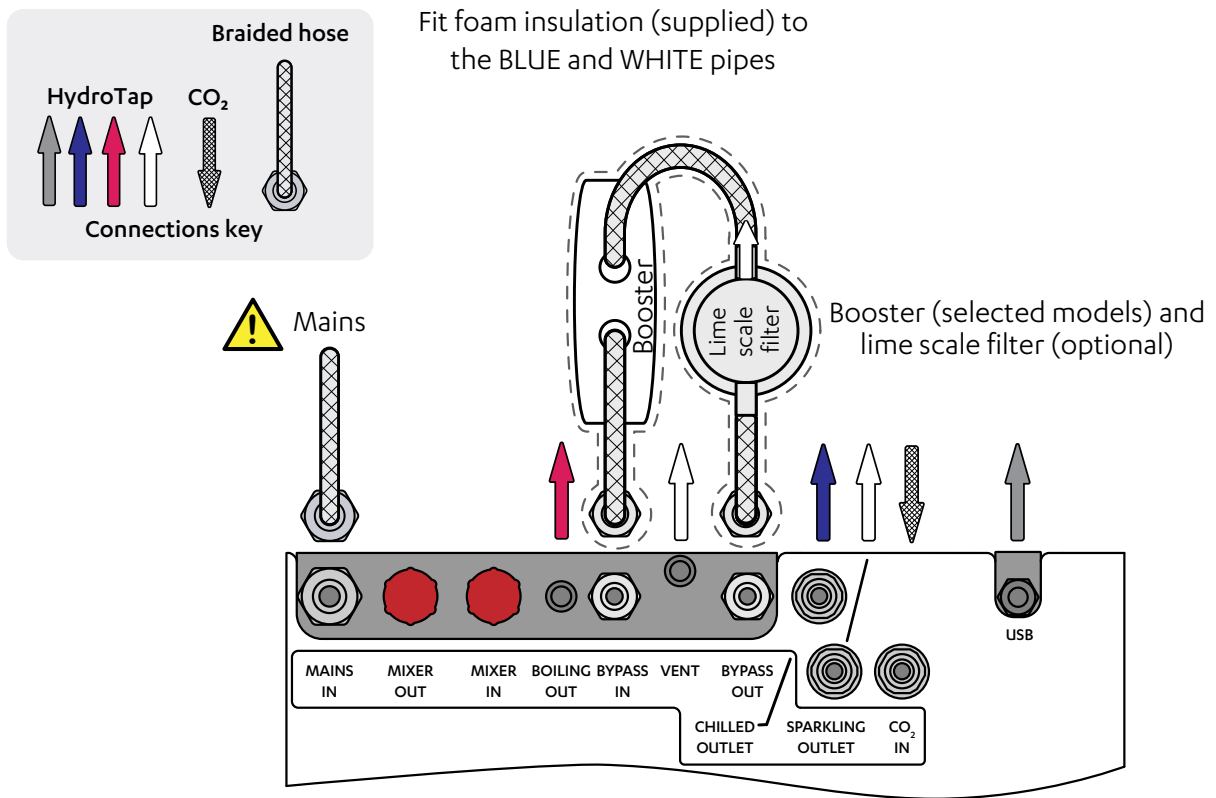

Example installation

Diagram for illustrative purposes only. Hoses are not shown to scale.

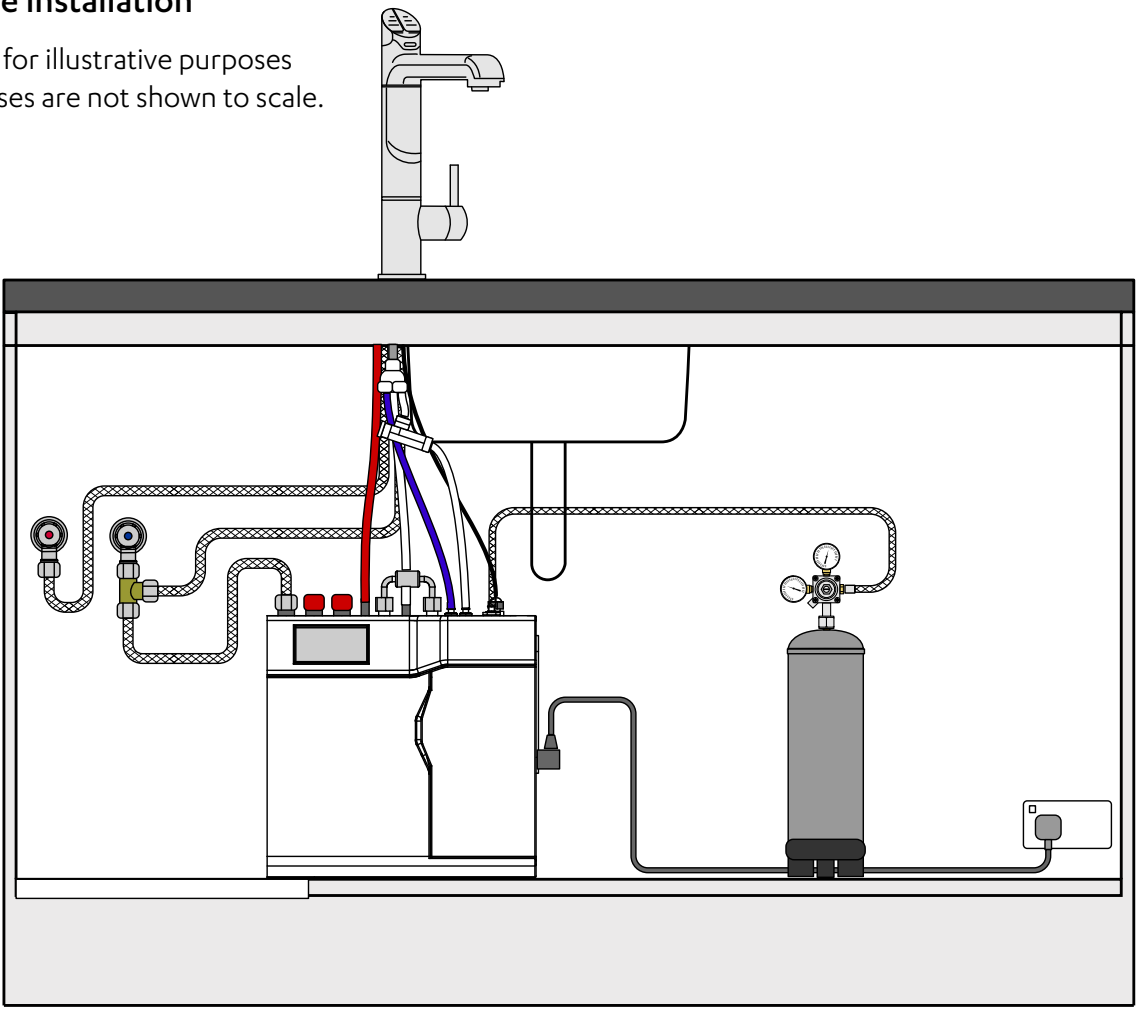

Section 4 Commercial & Residential Command Centre installation

4.3.4 BCS20 - BCS30, BCS Home All-in-One Classic 'Vented' tap

Command Centre connections

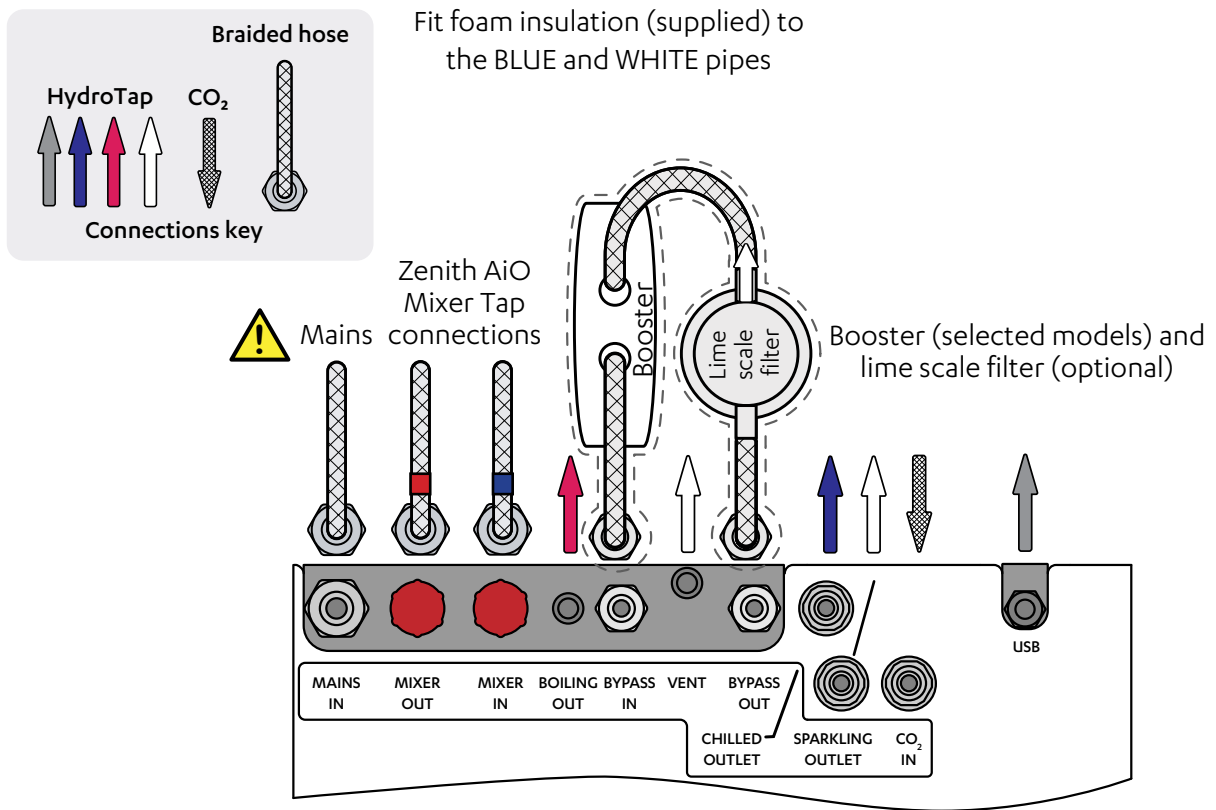

Example installation

Diagram for illustrative purposes only. Hoses are not shown to scale.

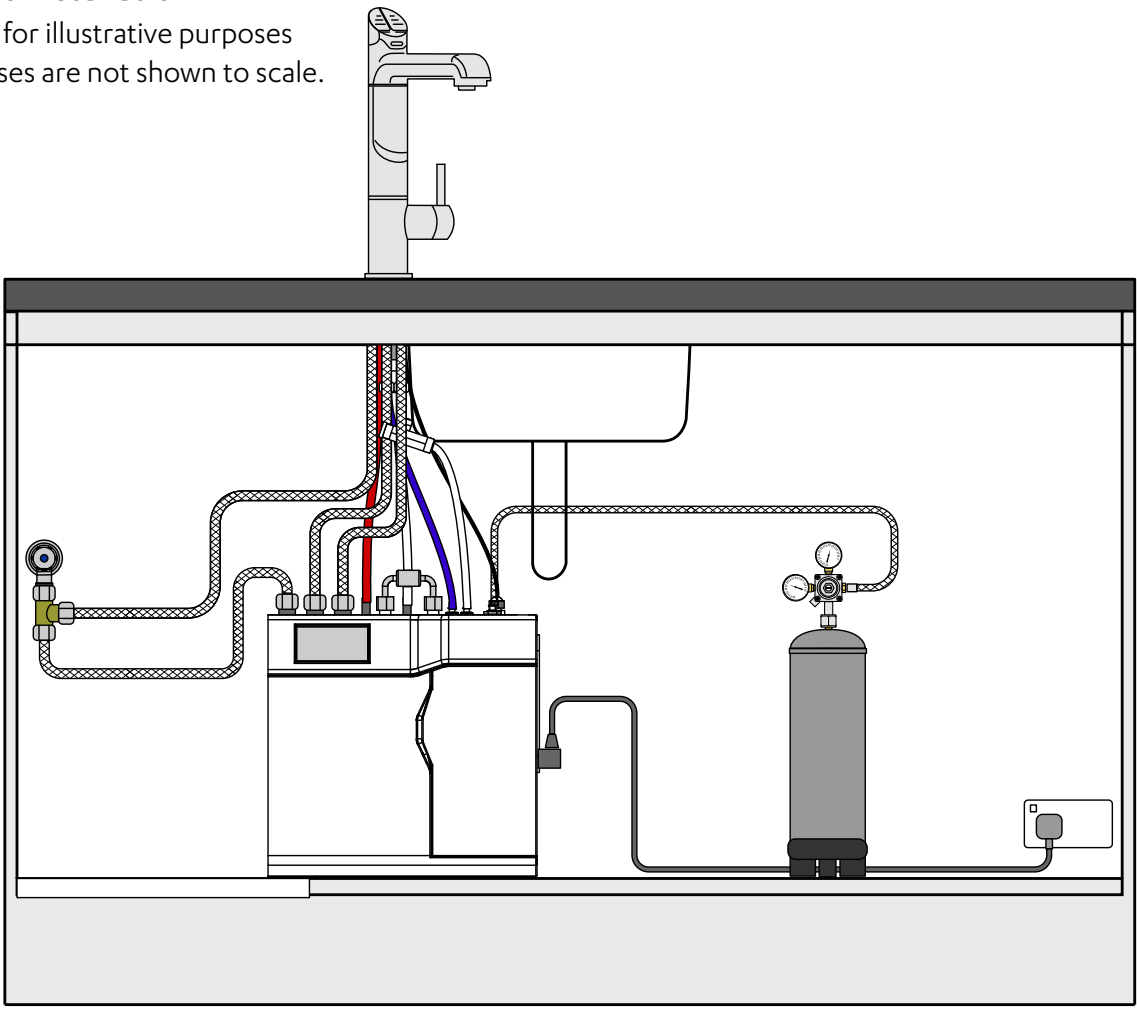

Section 4 Commercial & Residential Command Centre installation

4.4.1 BC40 - BC100 HydroTap models

Command Centre connections

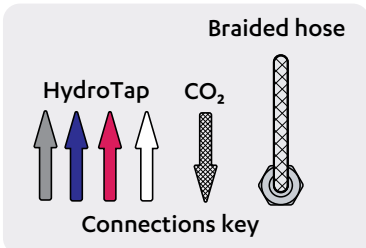

Fit foam insulation (supplied) to the BLUE and WHITE pipes

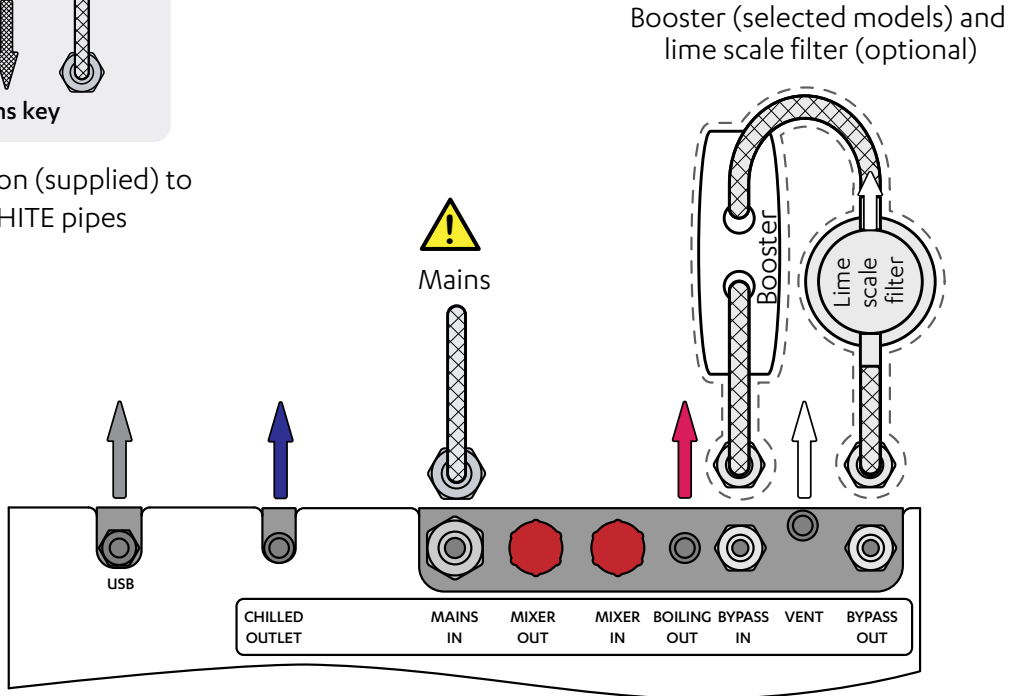

Example installation

Diagram for illustrative purposes only. Hoses are not shown to scale.

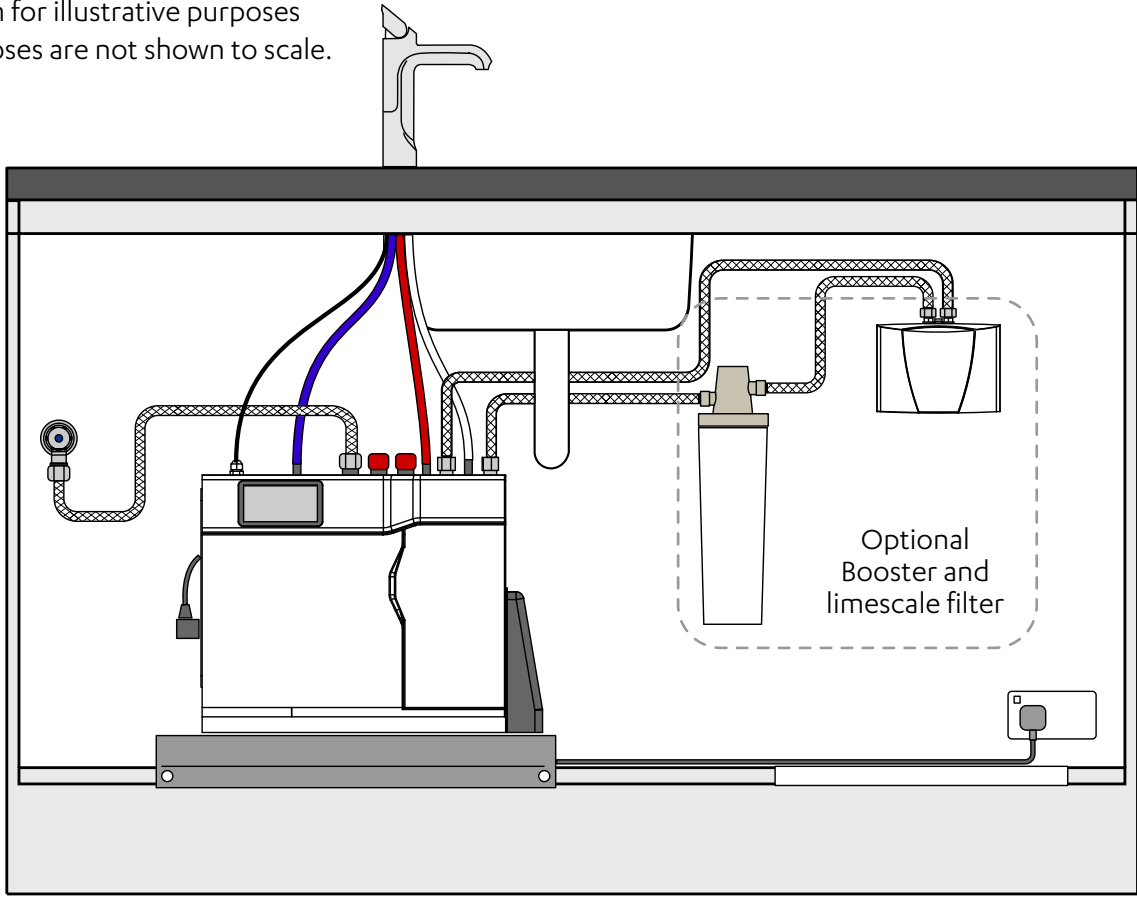

4.4.2 BC40 - BC100 HydroTap and vented mixer tap combinations

Command Centre connections

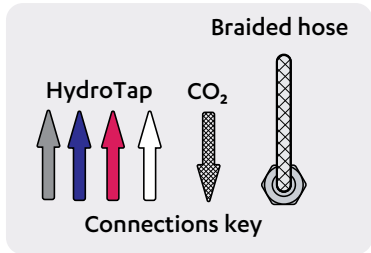

Fit foam insulation (supplied) to the BLUE and WHITE pipes

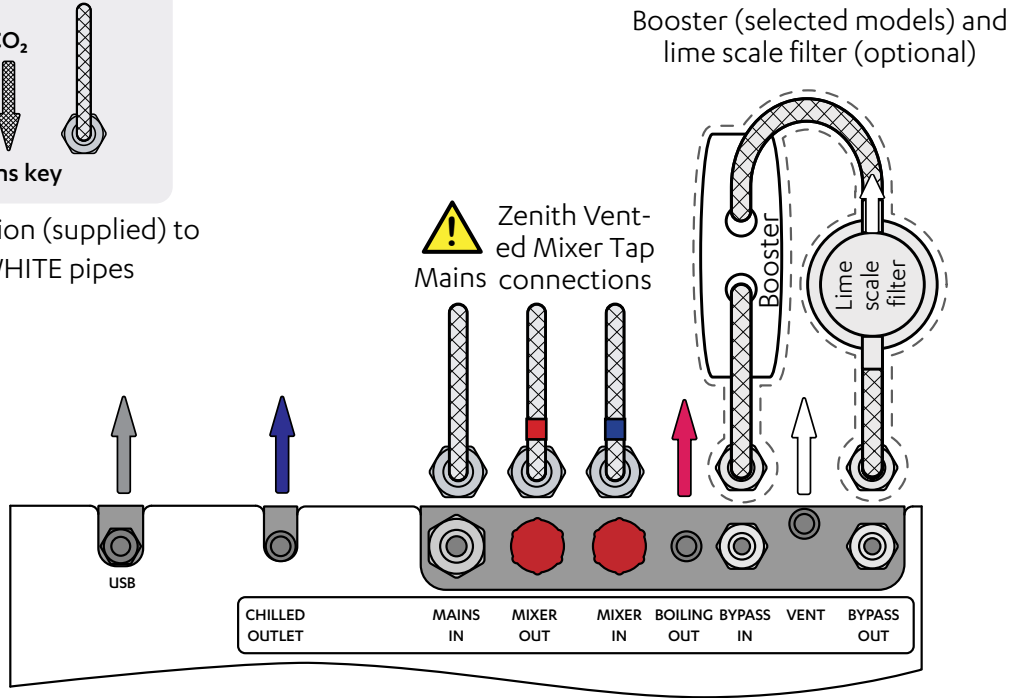

Example installation

Diagram for illustrative purposes only. Hoses are not shown to scale.

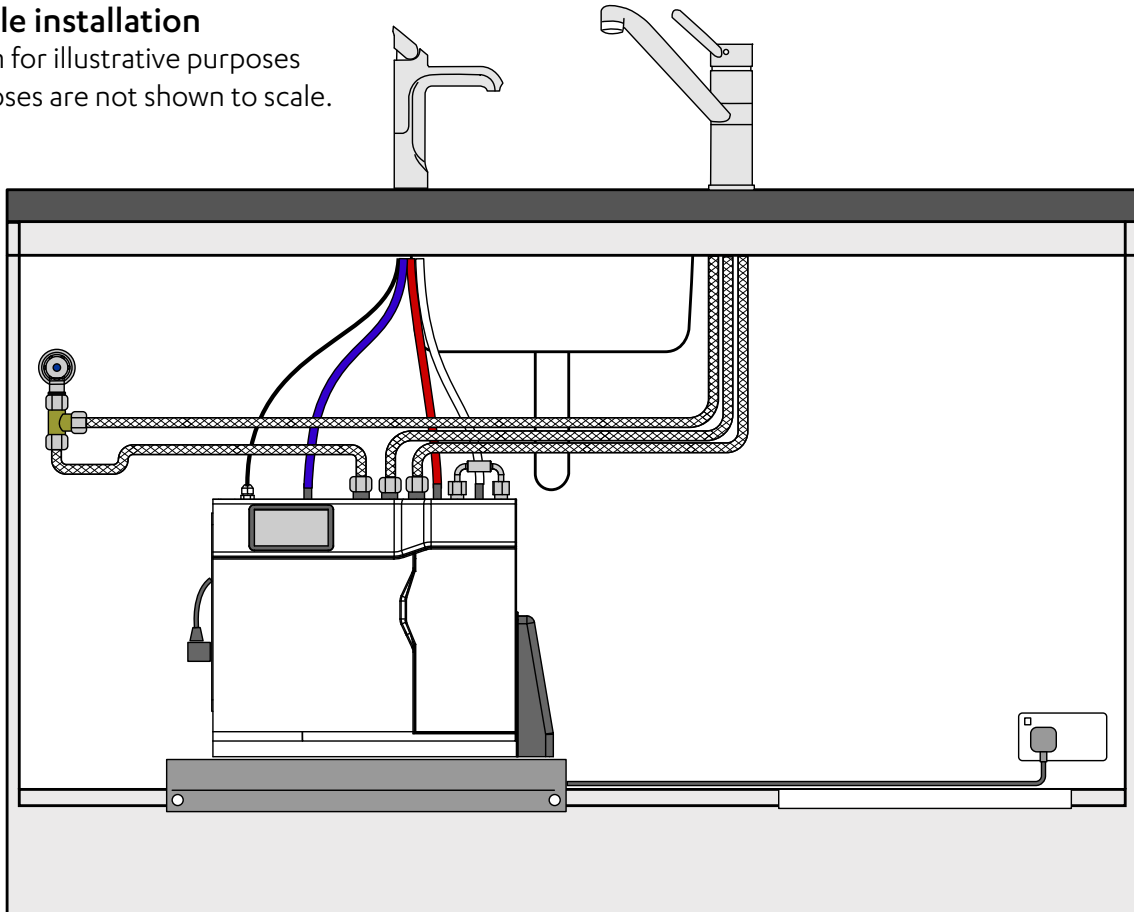

Section 4 Commercial & Residential Command Centre installation

4.4.3 BC40 - BC100 All-in-One 'Mains' tap
Command Centre connections

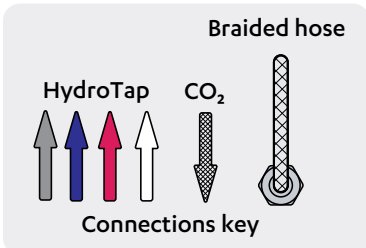

Fit foam insulation (supplied) to the BLUE and WHITE pipes

Booster (selected models) and lime scale filter (optional)

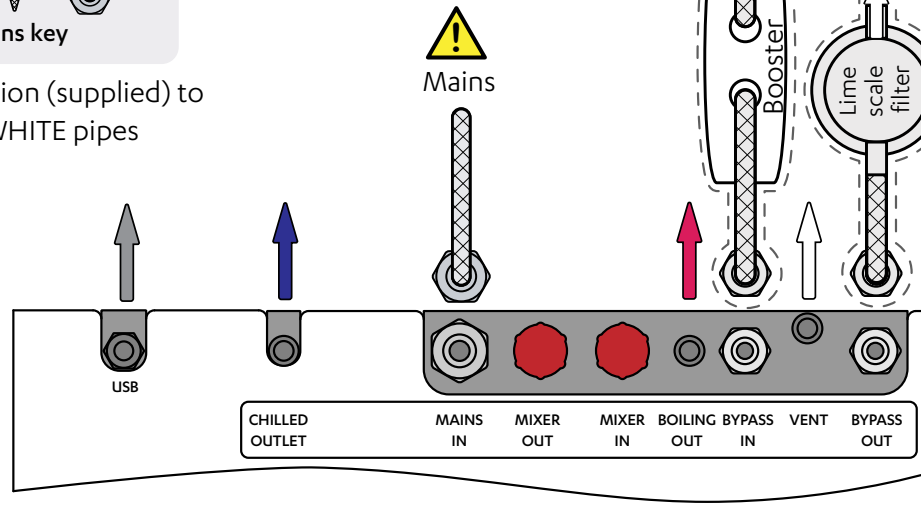

Example installation

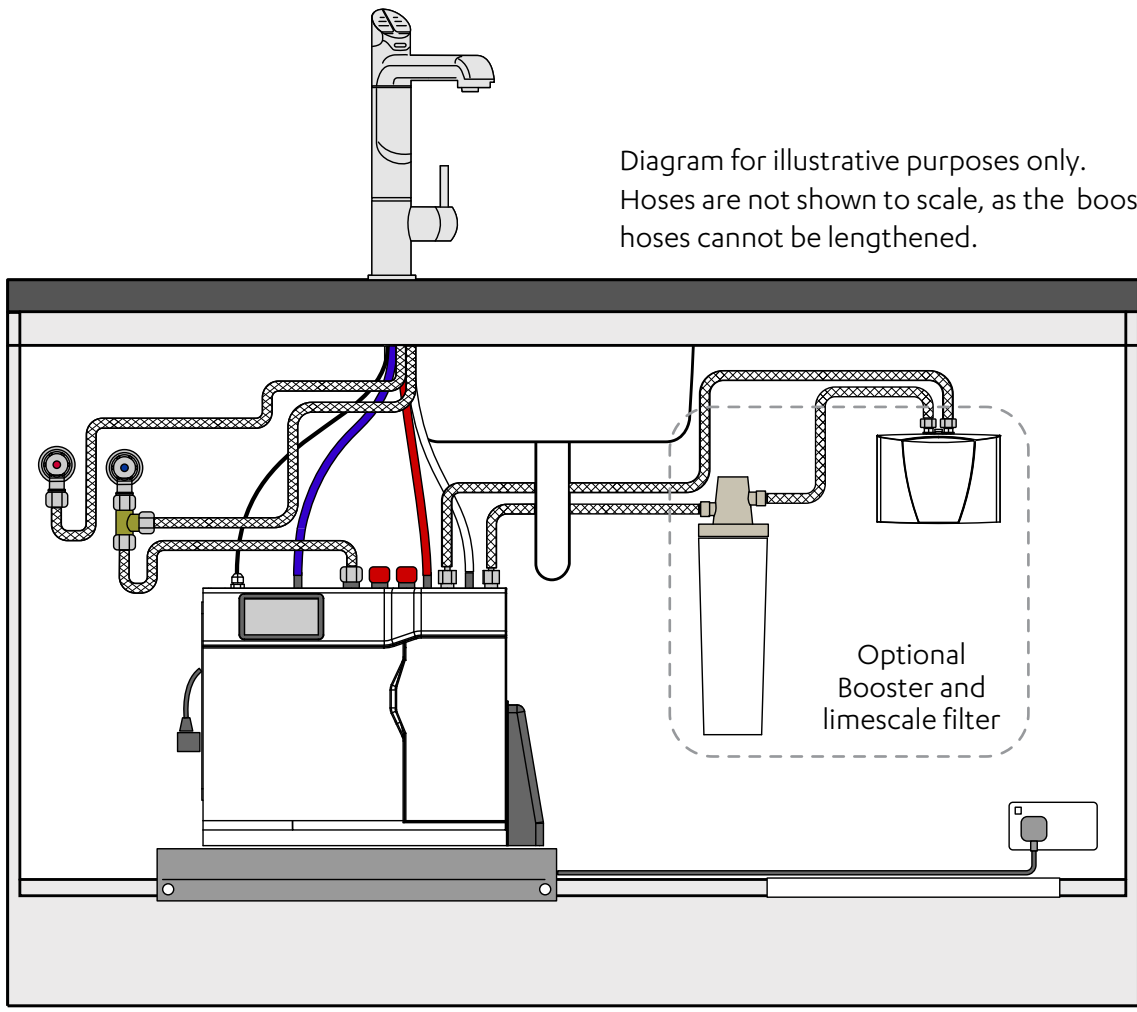

Section 4 Commercial & Residential Command Centre installation

4.4.4 BC40 - BC100 All-in-One Classic 'Vented' tap

Command Centre connections

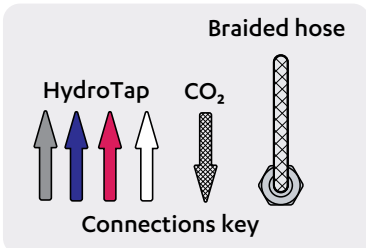

Fit foam insulation (supplied) to the BLUE and WHITE pipes

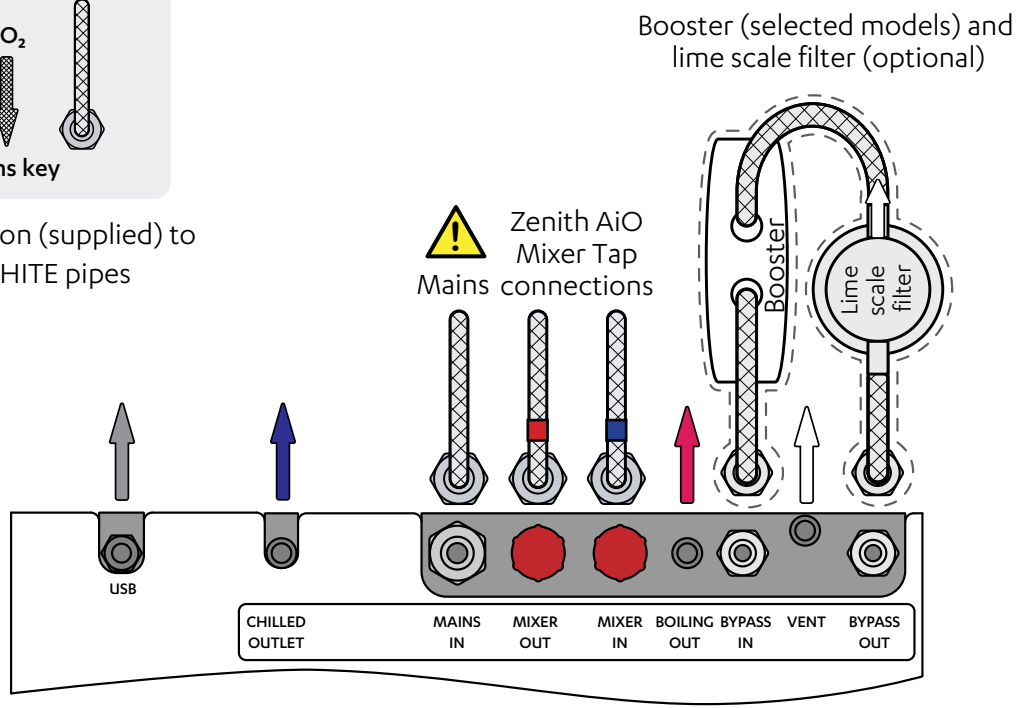

Example Installations

Diagram for illustrative purposes only. Hoses are not shown to scale.

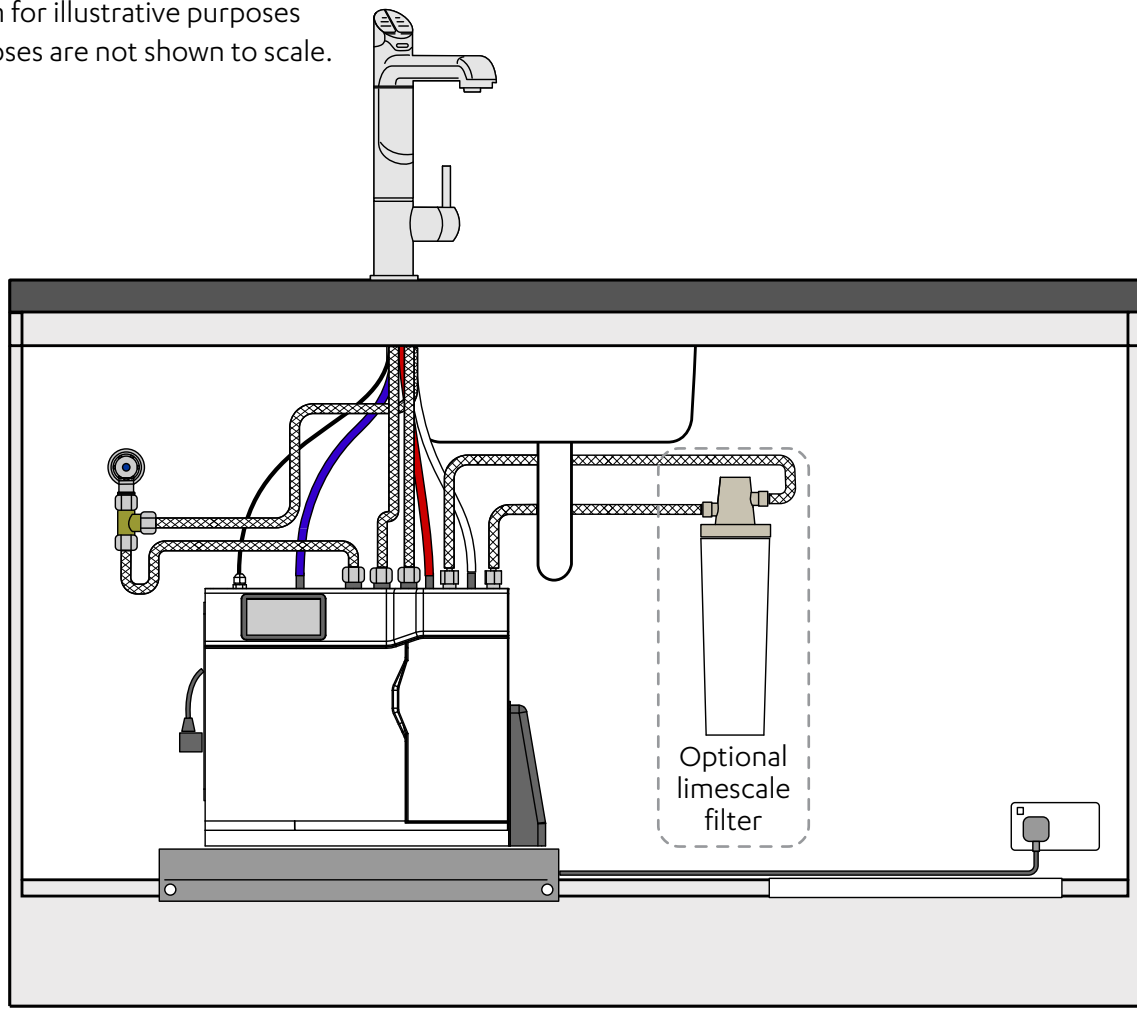

Section 4 Commercial & Residential Command Centre installation

4.5.1 BC20 - BC30, BC Home HydroTap models

Command Centre connections

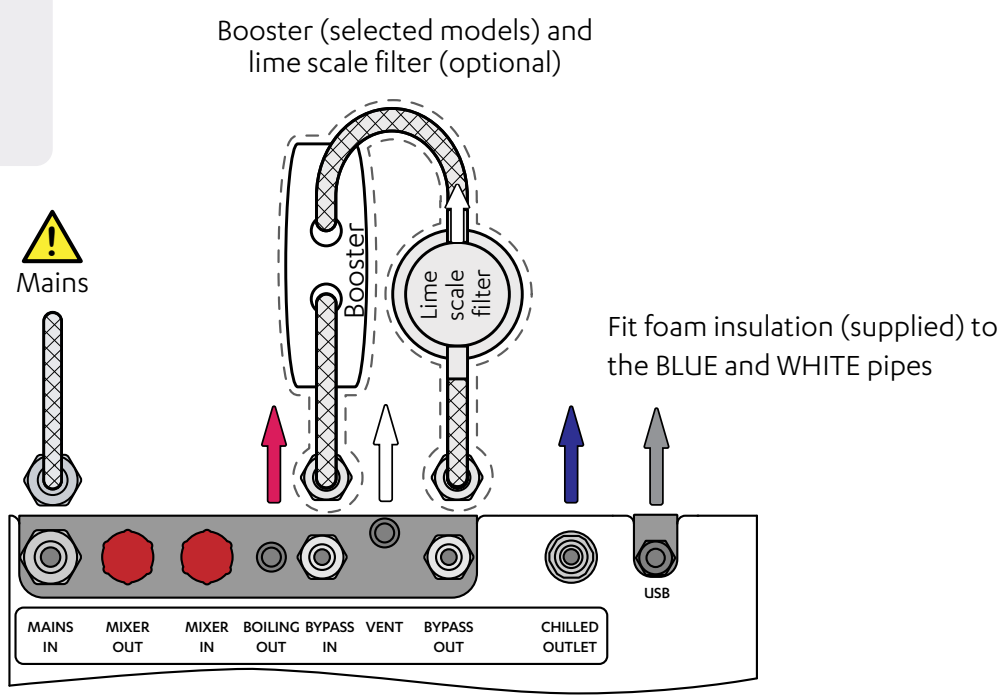
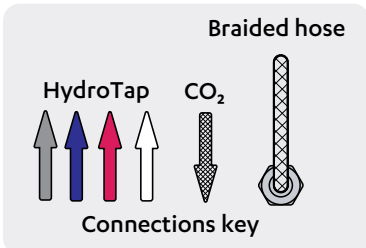

Example installation

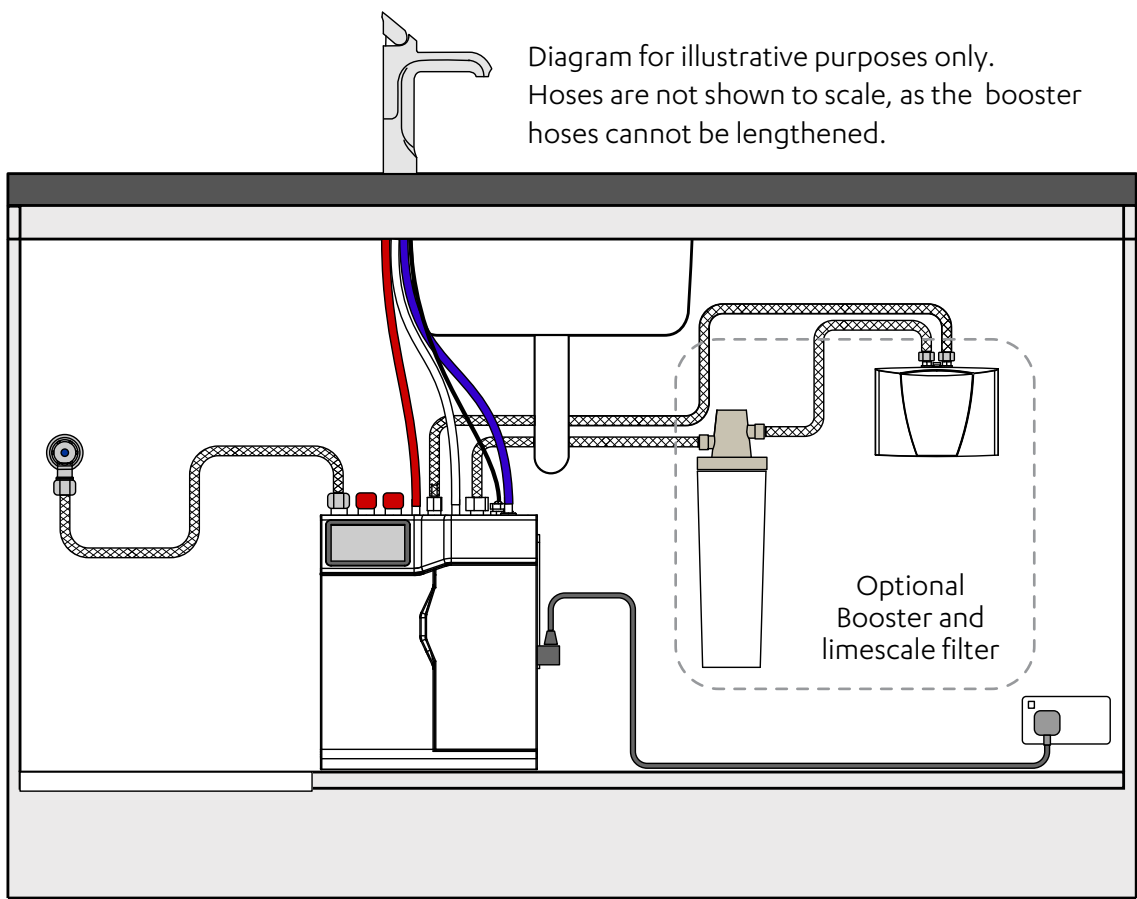

Section 4 Commercial & Residential Command Centre installation

4.5.2 BC20 - BC30, BC Home HydroTap and vented mixer tap combinations

Command Centre connections

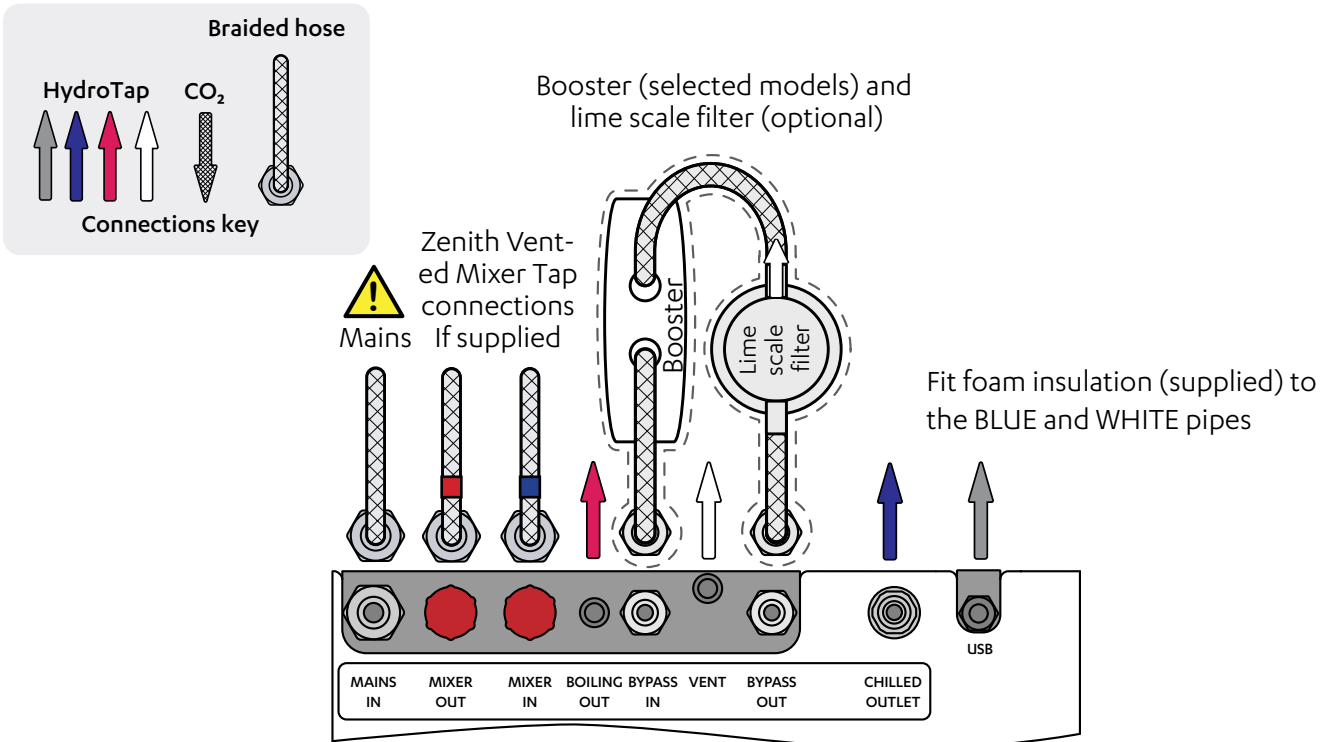

Example Installations

Diagram for illustrative purposes only. Hoses are not shown to scale.

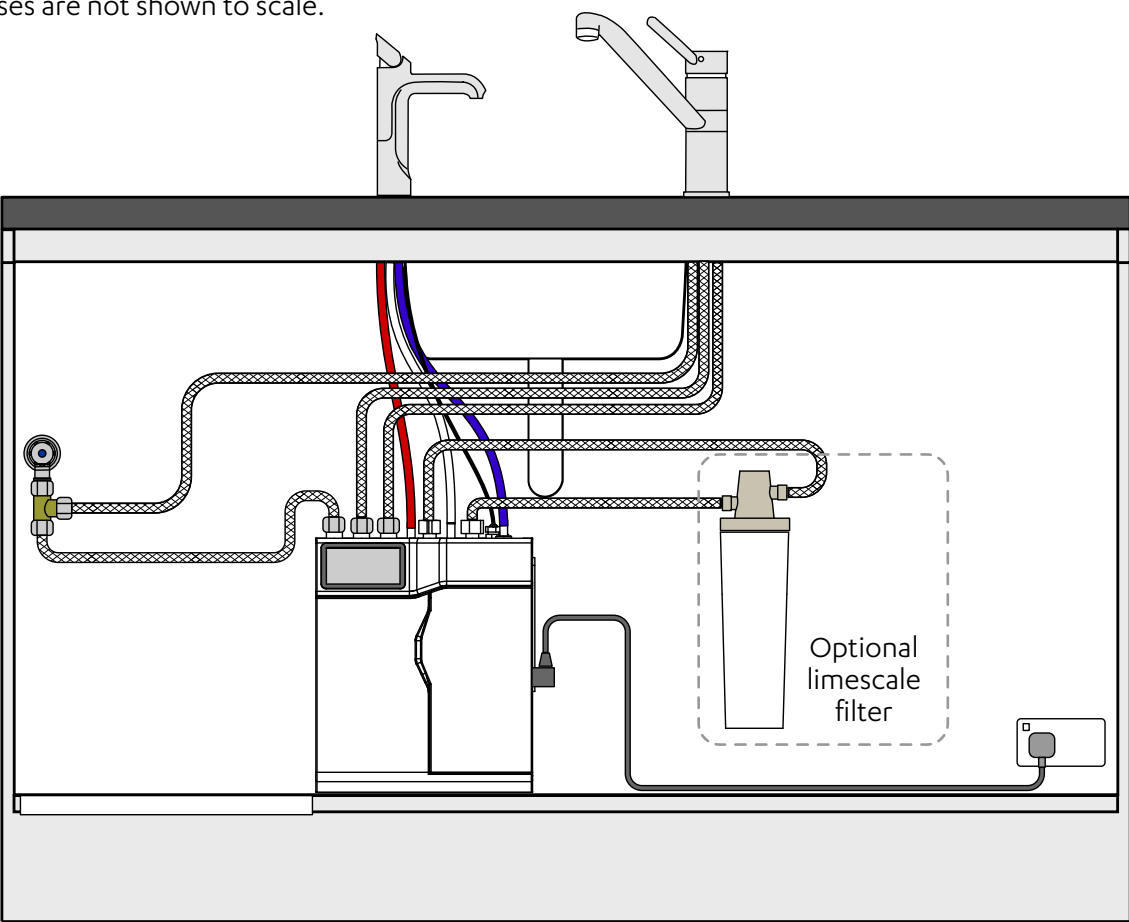

Section 4 Commercial & Residential Command Centre installation

4.5.3 BC20 - BC30, BC Home All-in-One 'Mains' tap

Command Centre connections

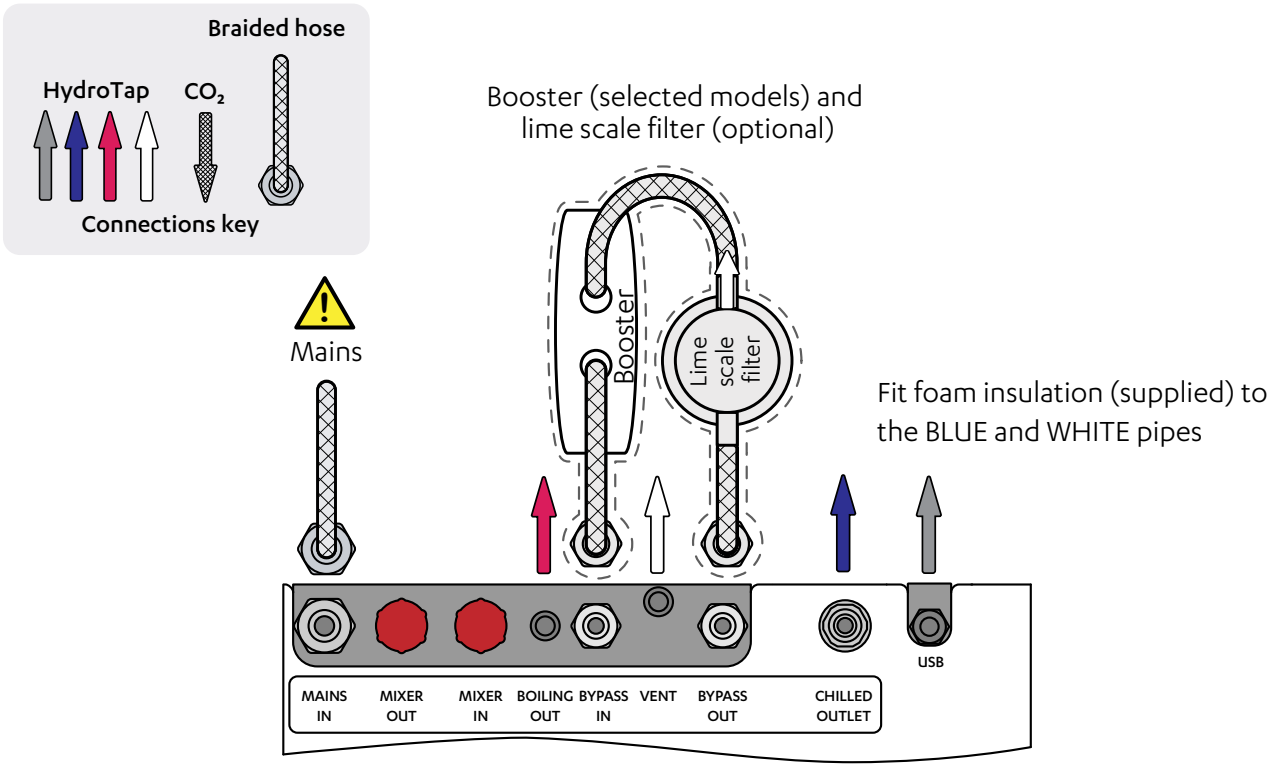

Example Installations

Diagram for illustrative purposes only. Hoses are not shown to scale.

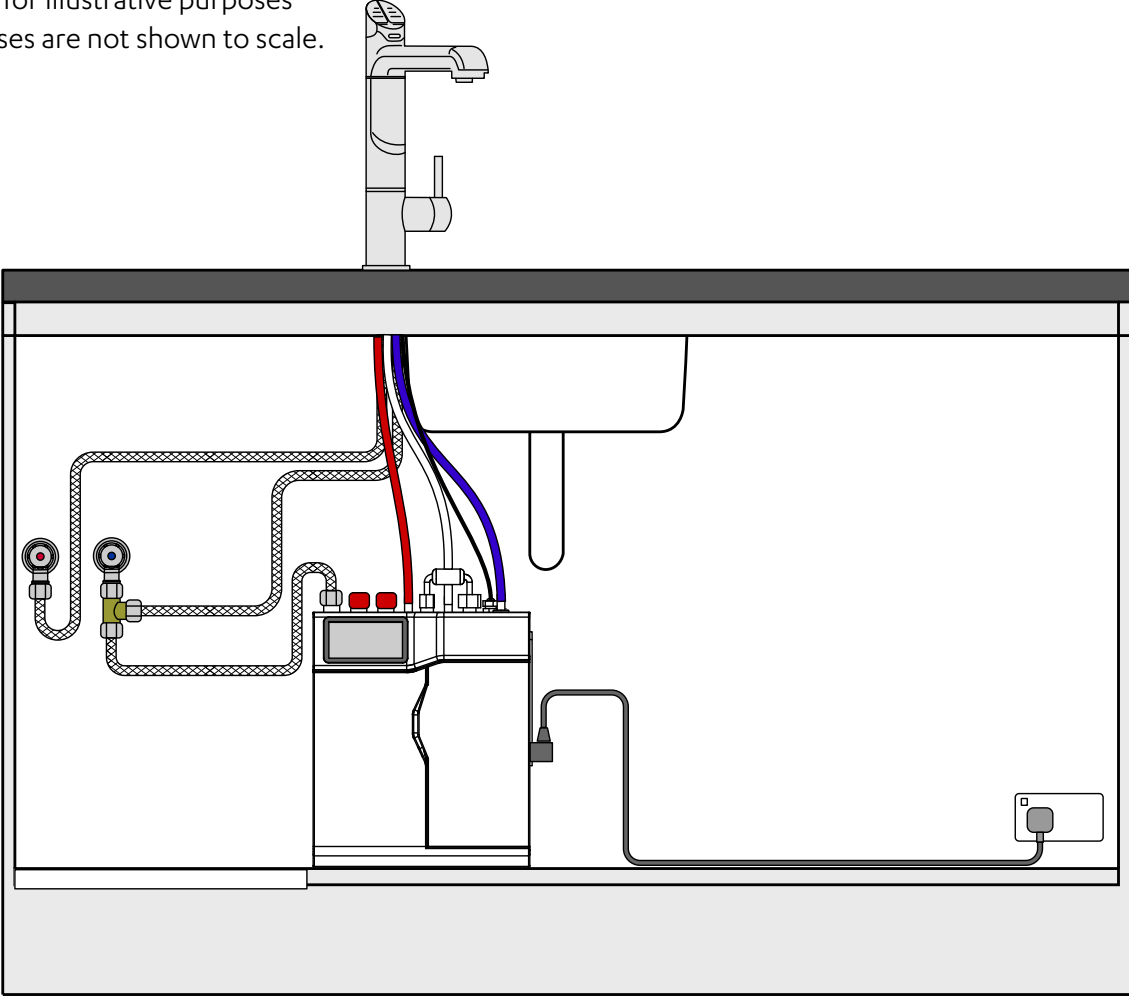

4.5.4 BC20 - BC30, BC Home All-in-One Classic 'Vented' tap

Command Centre connections

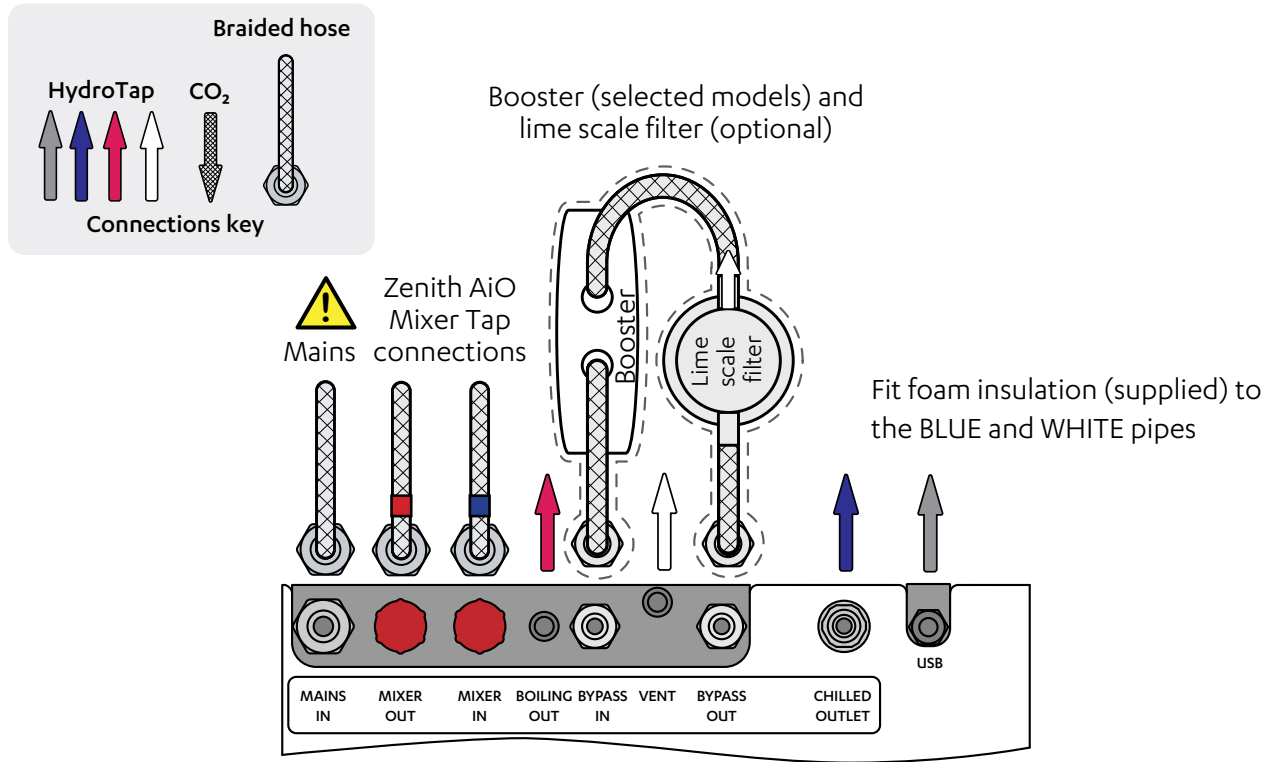

Example installation

Diagram for illustrative purposes only. Hoses are not shown to scale.

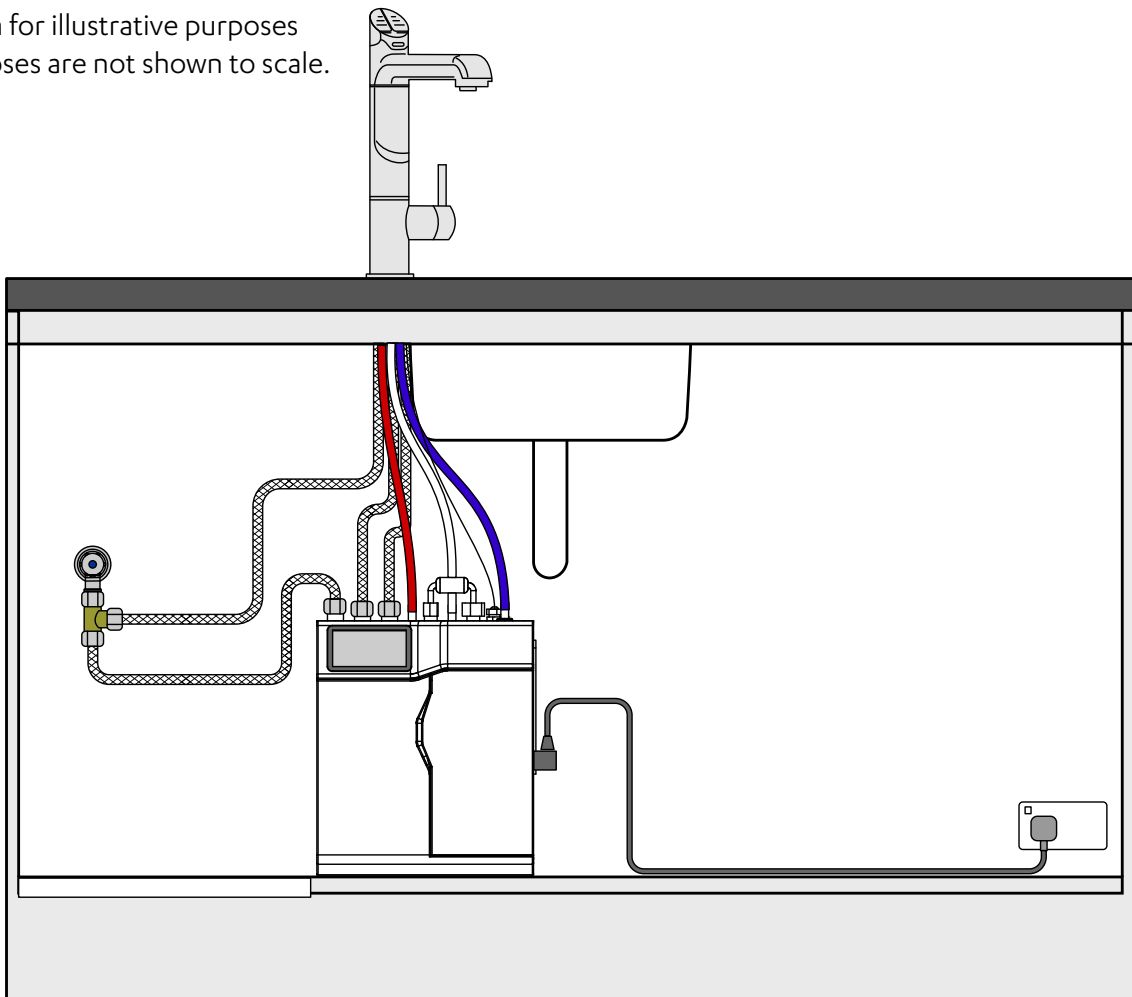

4.6.1 B60 - B100, B Home HydroTap boiling models

Command Centre connections

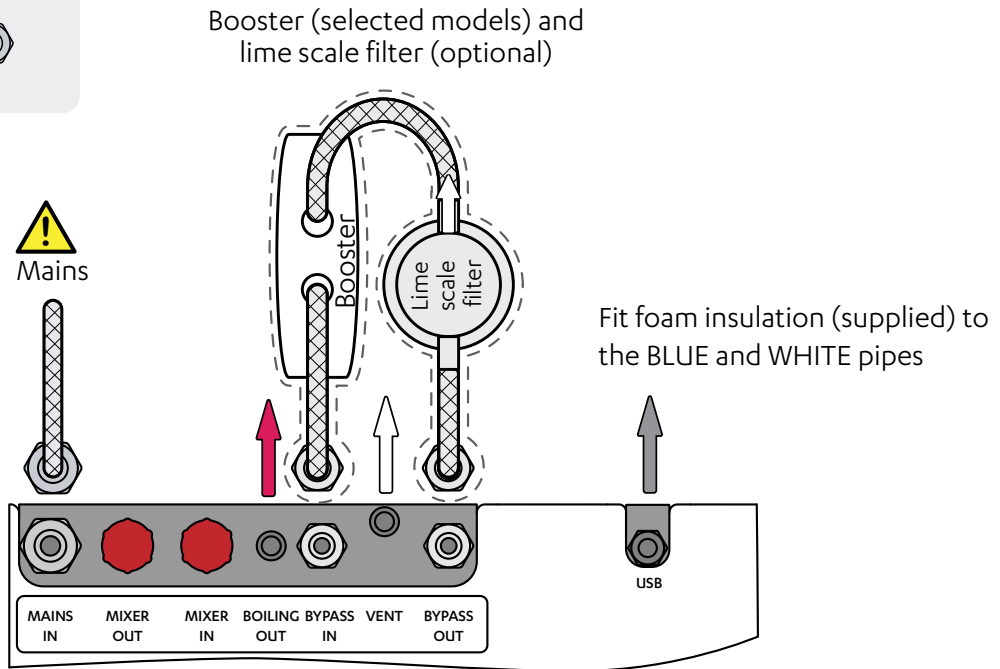
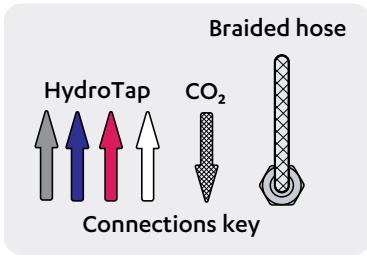

Example installation

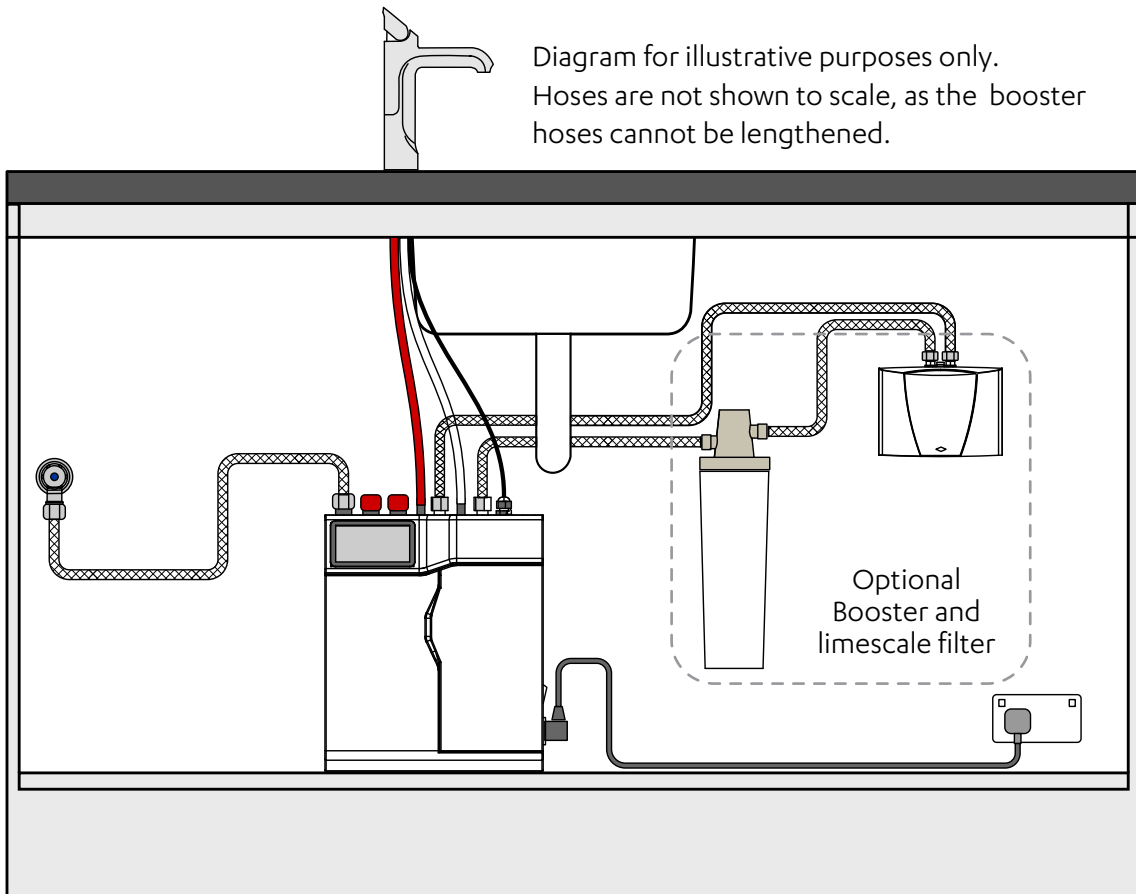

Section 4 Commercial & Residential Command Centre installation

4.6.2 BA60 - BA100, BA Home HydroTap boiling ambient models

Command Centre connections

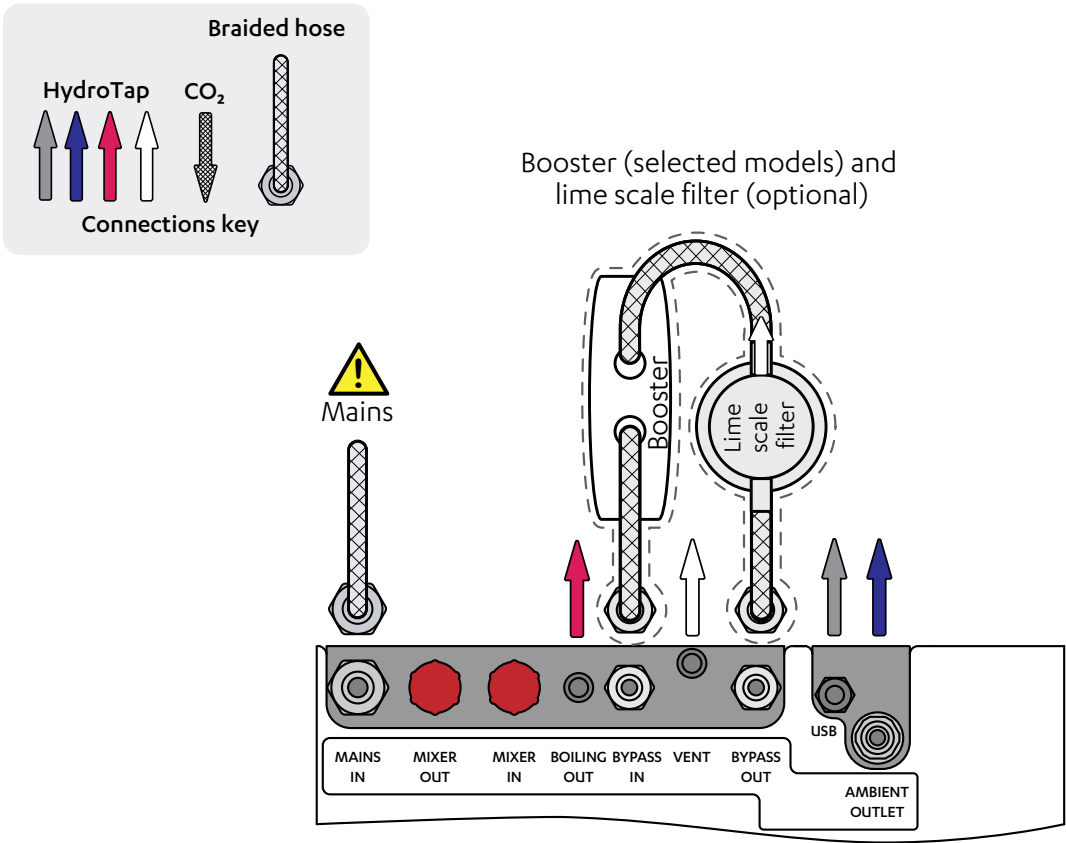

Example installation

Diagram for illustrative purposes only. Hoses are not shown to scale.

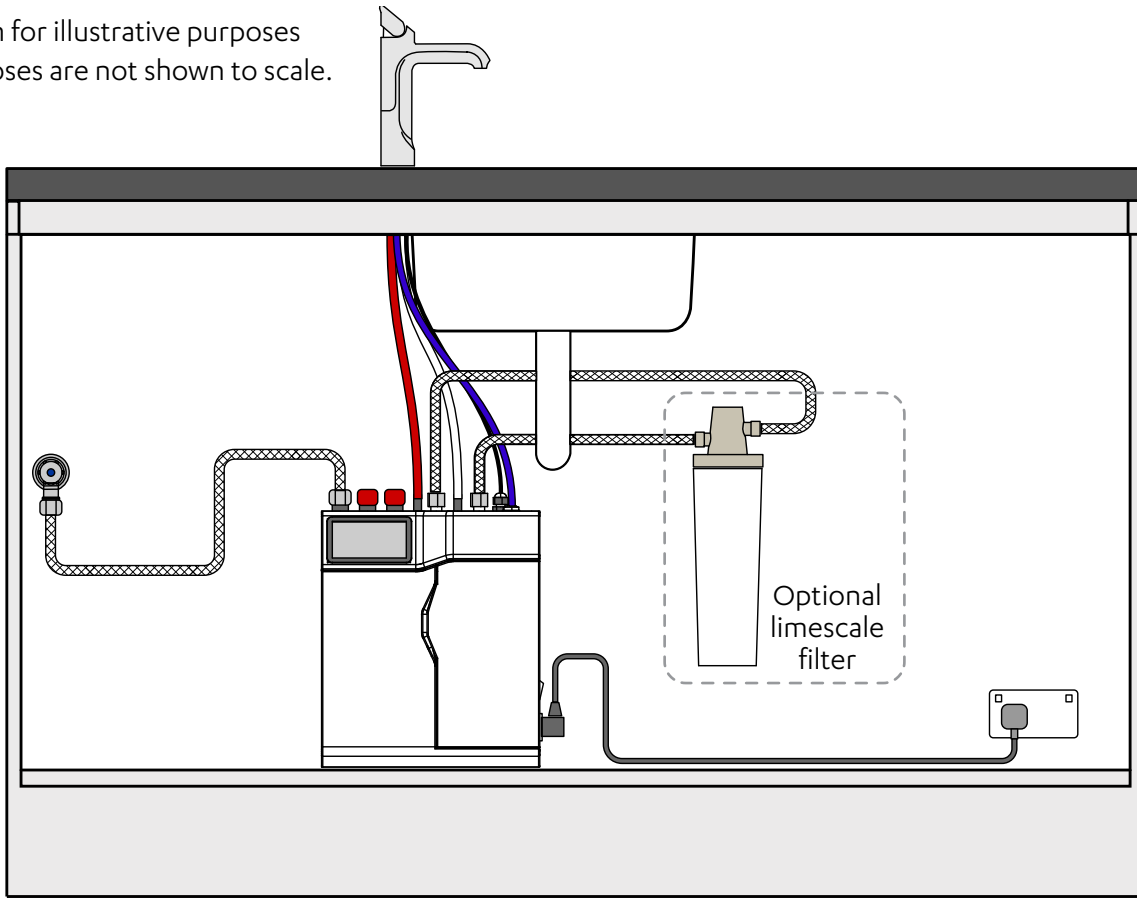

Section 4 Commercial & Residential Command Centre installation

4.6.3 B60 - B100, B Home HydroTap boiling and vented mixer tap combinations
Command Centre connections

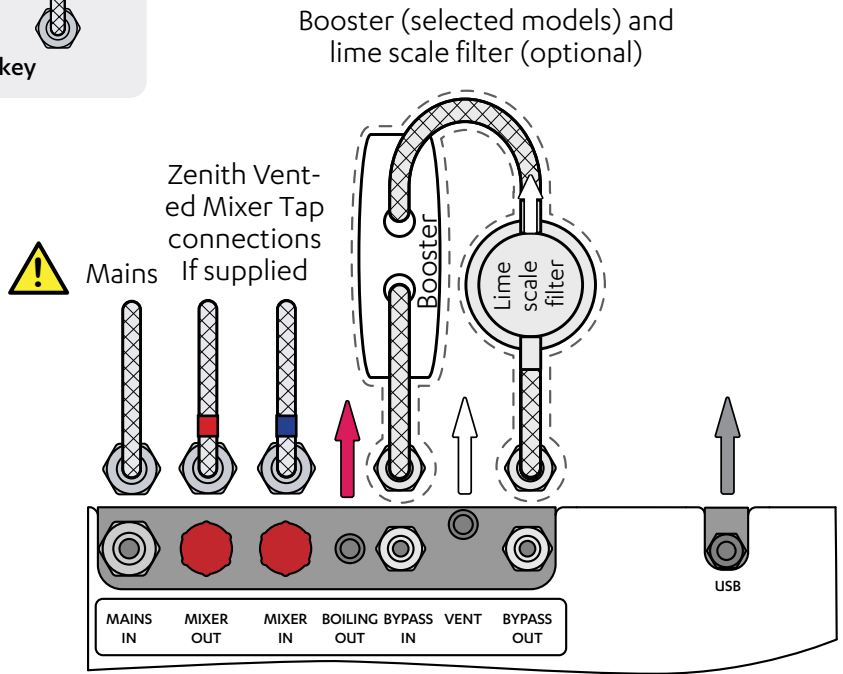
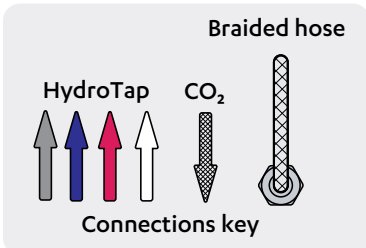

Example installation

Diagram for illustrative purposes only. Hoses are not shown to scale.

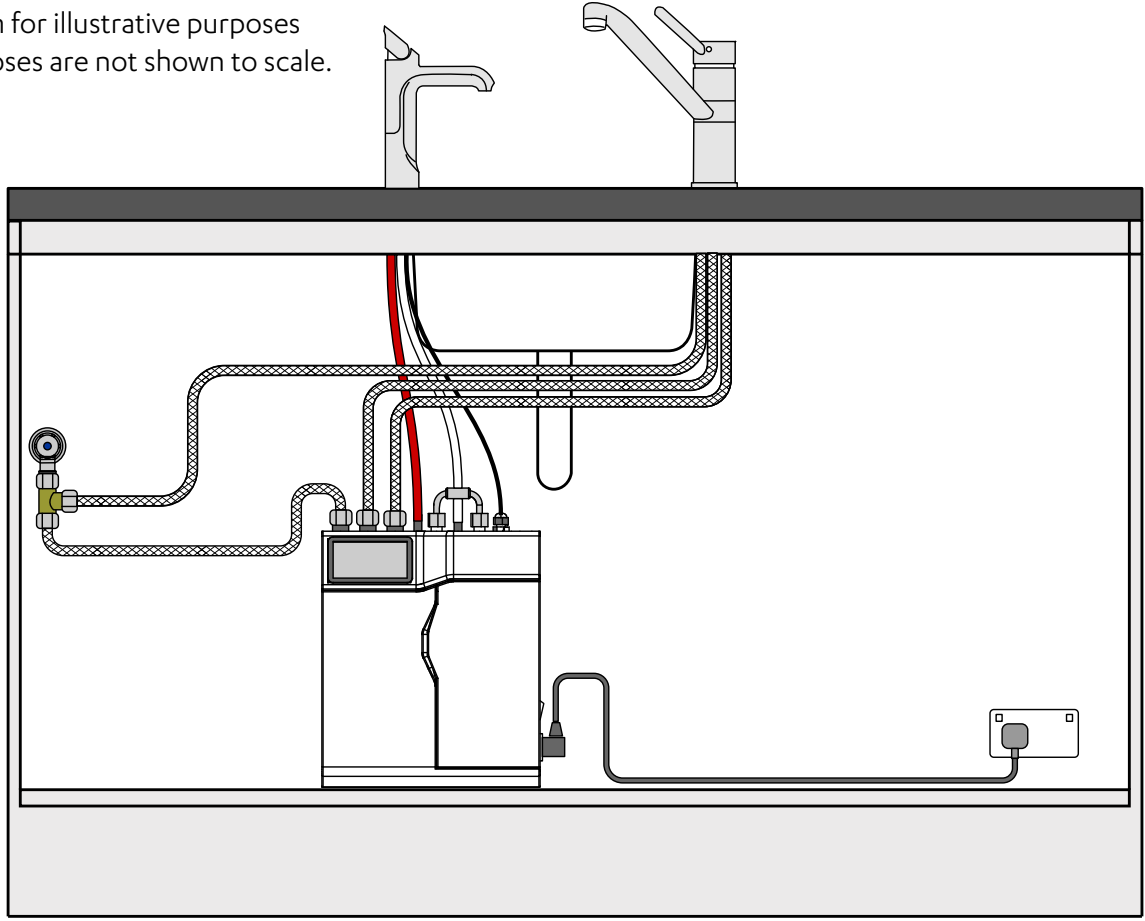

Section 4 Commercial & Residential Command Centre installation

4.6.4 BA60 - BA100, BA Home HydroTap boiling ambient and mixer tap combinations
Command Centre connections

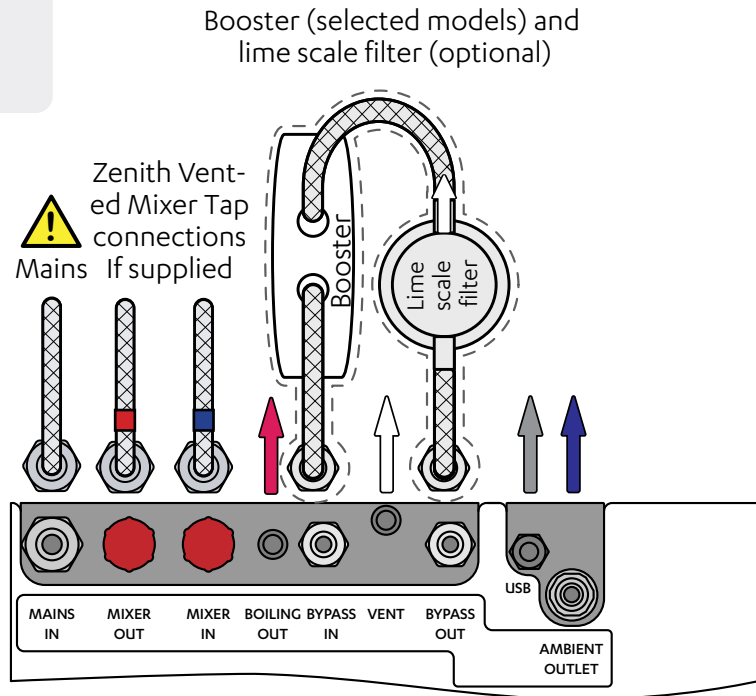
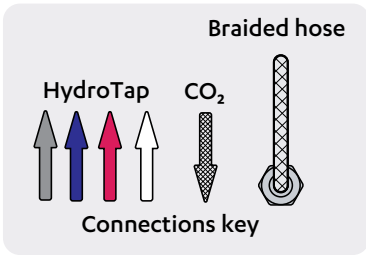

Example installation

Diagram for illustrative purposes only. Hoses are not shown to scale.

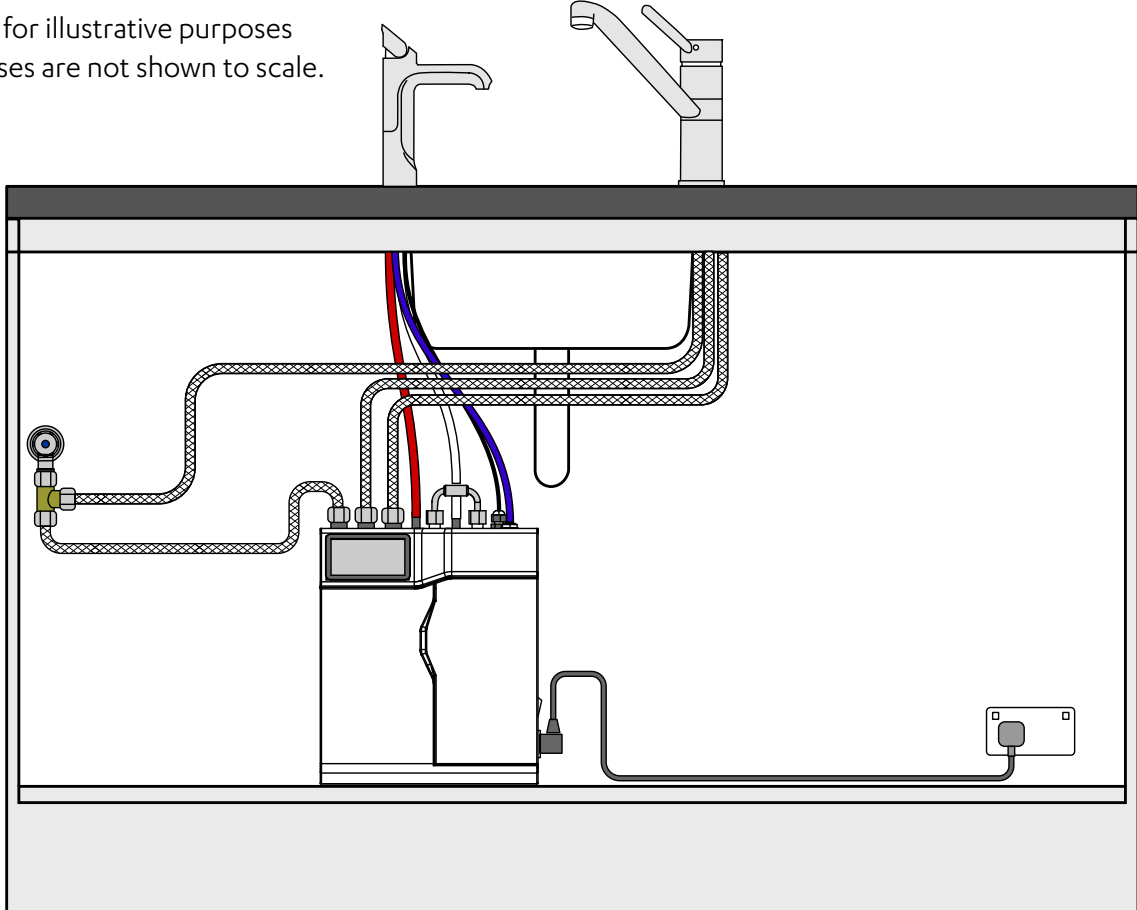

4.6.5 B60 - B100, B Home HydroTap boiling with mains mixer tap models

Command Centre connections

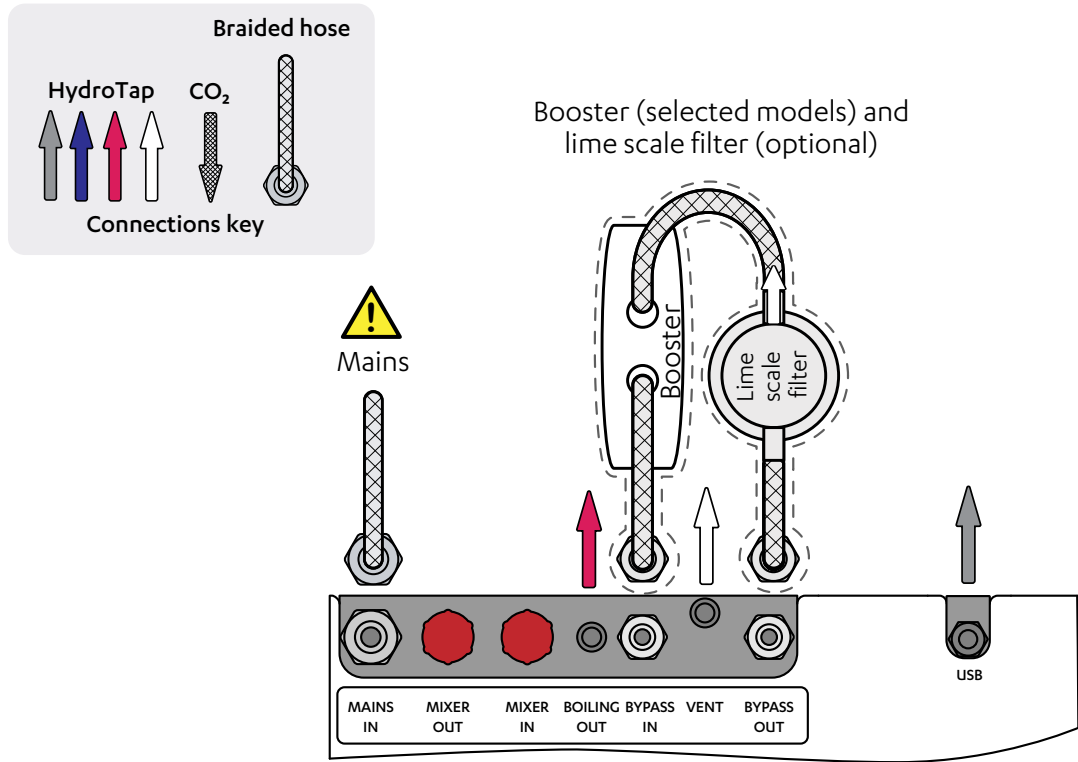

Example installation

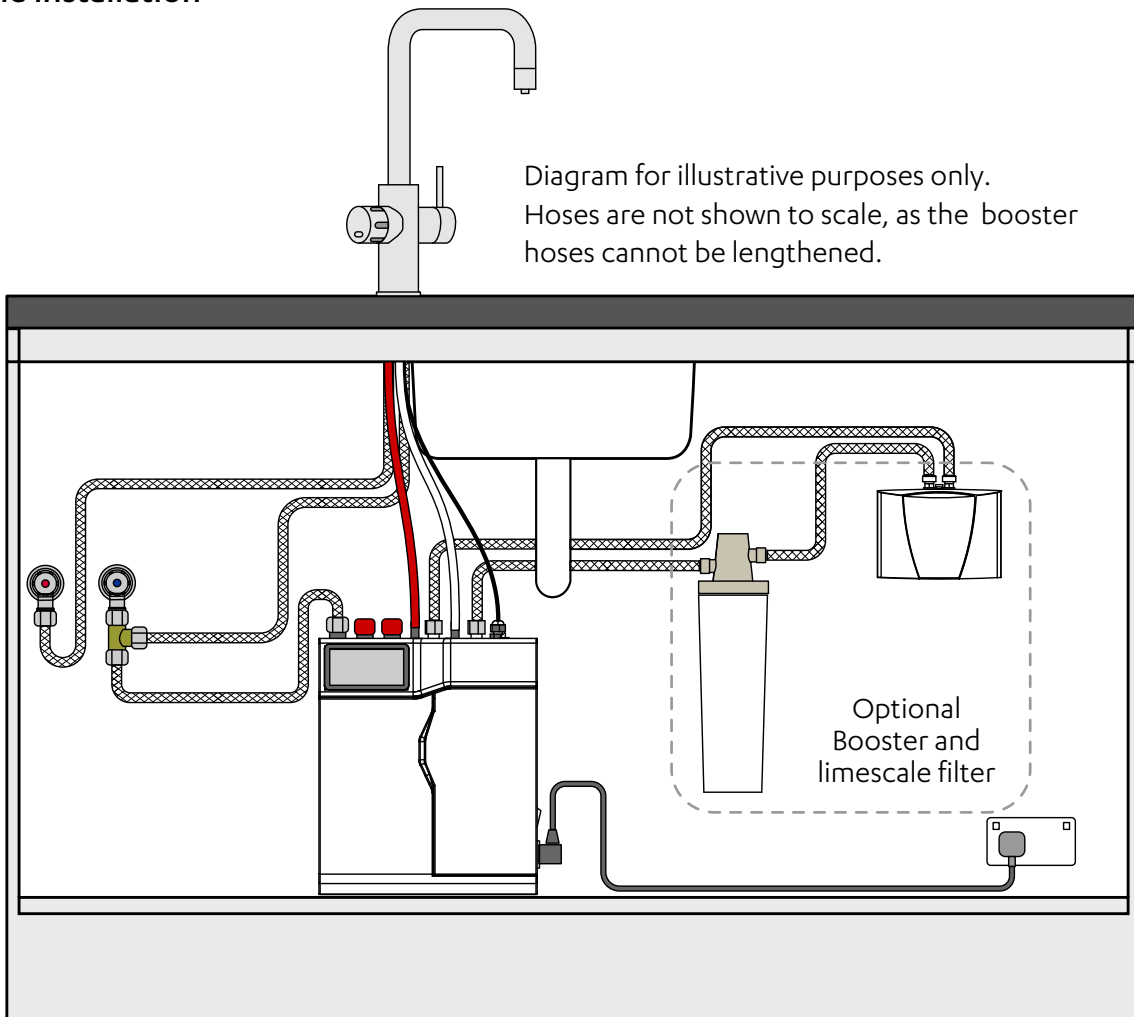

Section 4 Commercial & Residential Command Centre installation

4.6.6 BA60 - BA100, BA Home HydroTap boiling ambient with mains mixer tap Command Centre connections

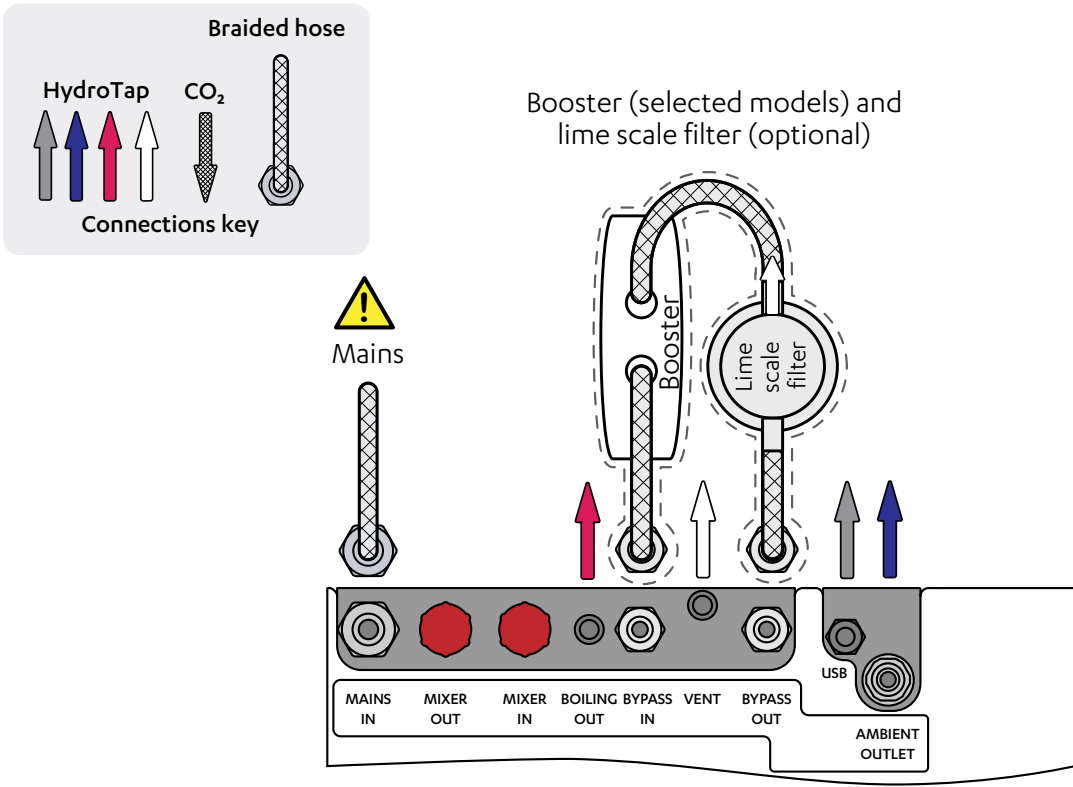

Example installation

Diagram for illustrative purposes only. Hoses are not shown to scale.

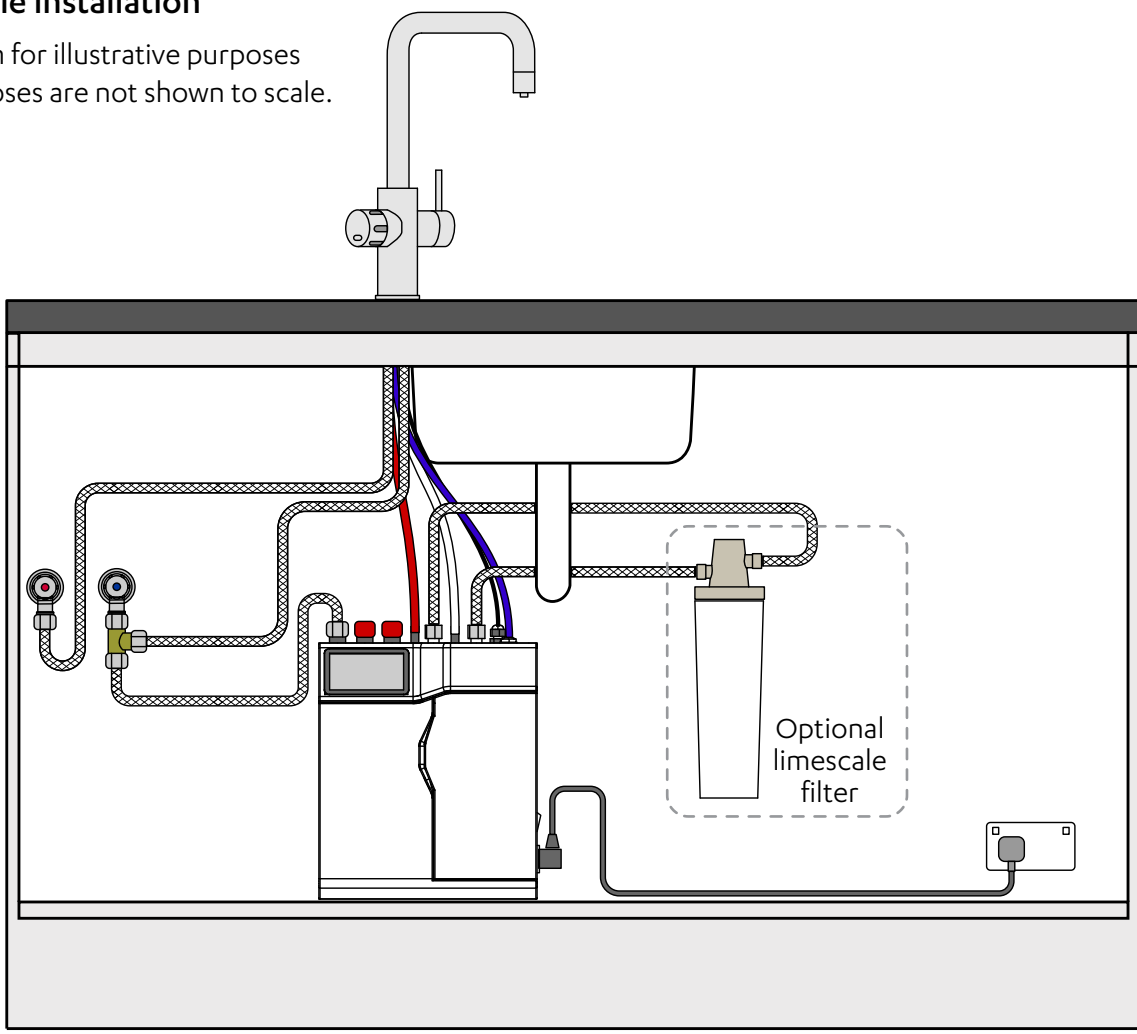

4.7.1 CS100 Chilled and sparkling HydroTap models

Command Centre connections

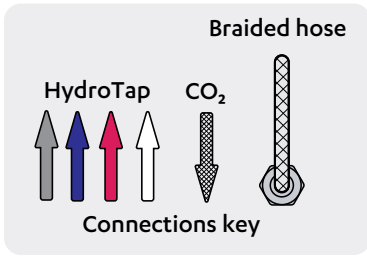

Fit foam insulation (supplied) to the BLUE and WHITE pipes

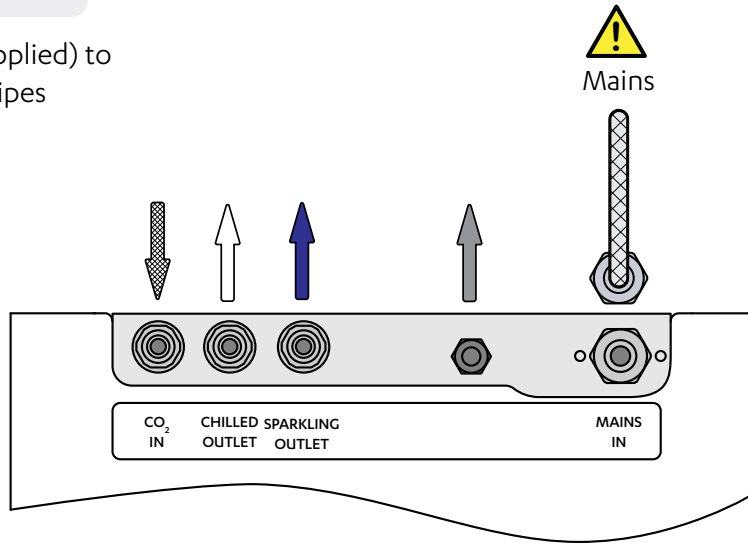

Example installation

Diagram for illustrative purposes only. Hoses are not shown to scale.

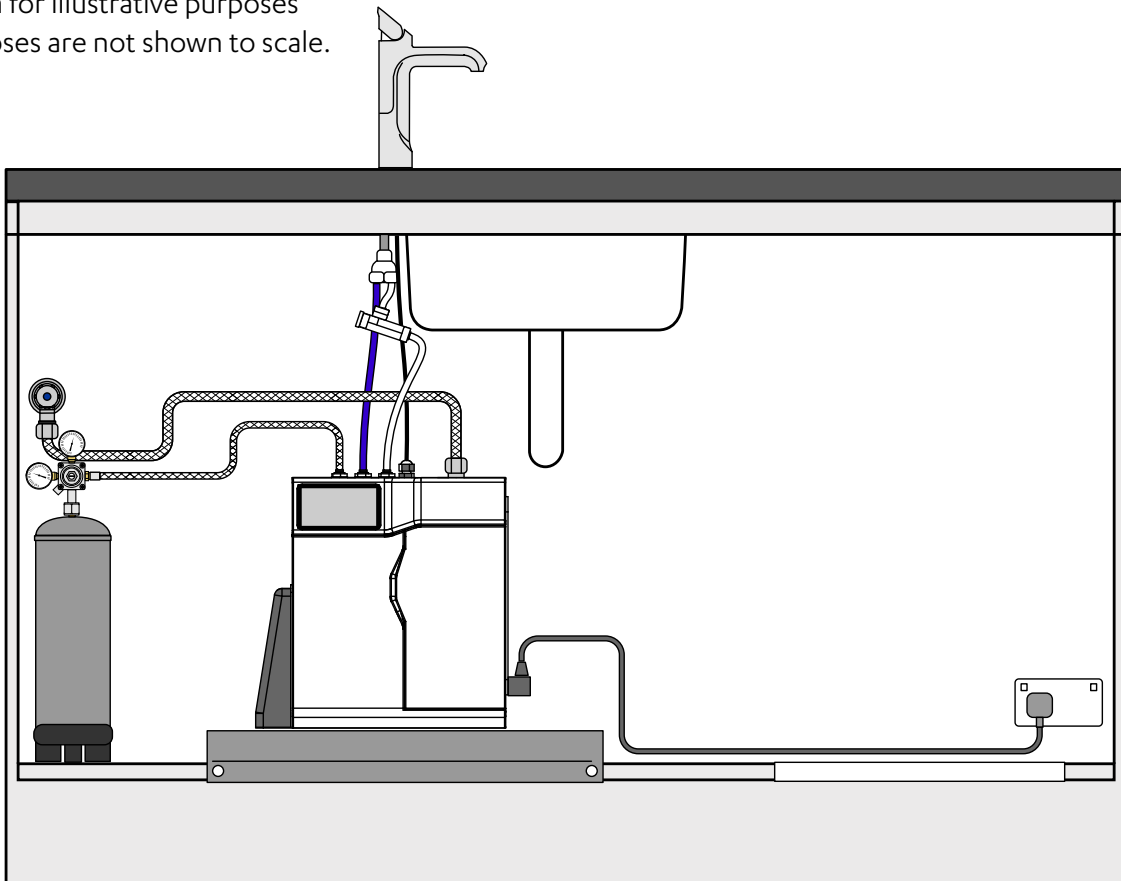

Section 4 Commercial & Residential Command Centre installation

4.7.2 CS100 Chilled, sparkling and mixed hot & cold
Command Centre connections

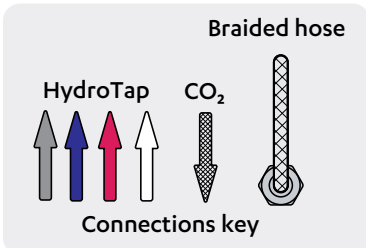

Fit foam insulation (supplied) to the BLUE and WHITE pipes

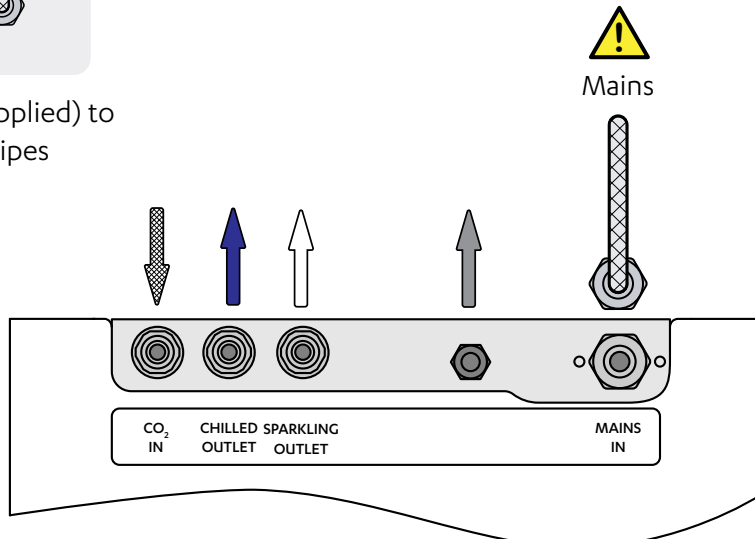

Example installation

Diagram for illustrative purposes only. Hoses are not shown to scale.

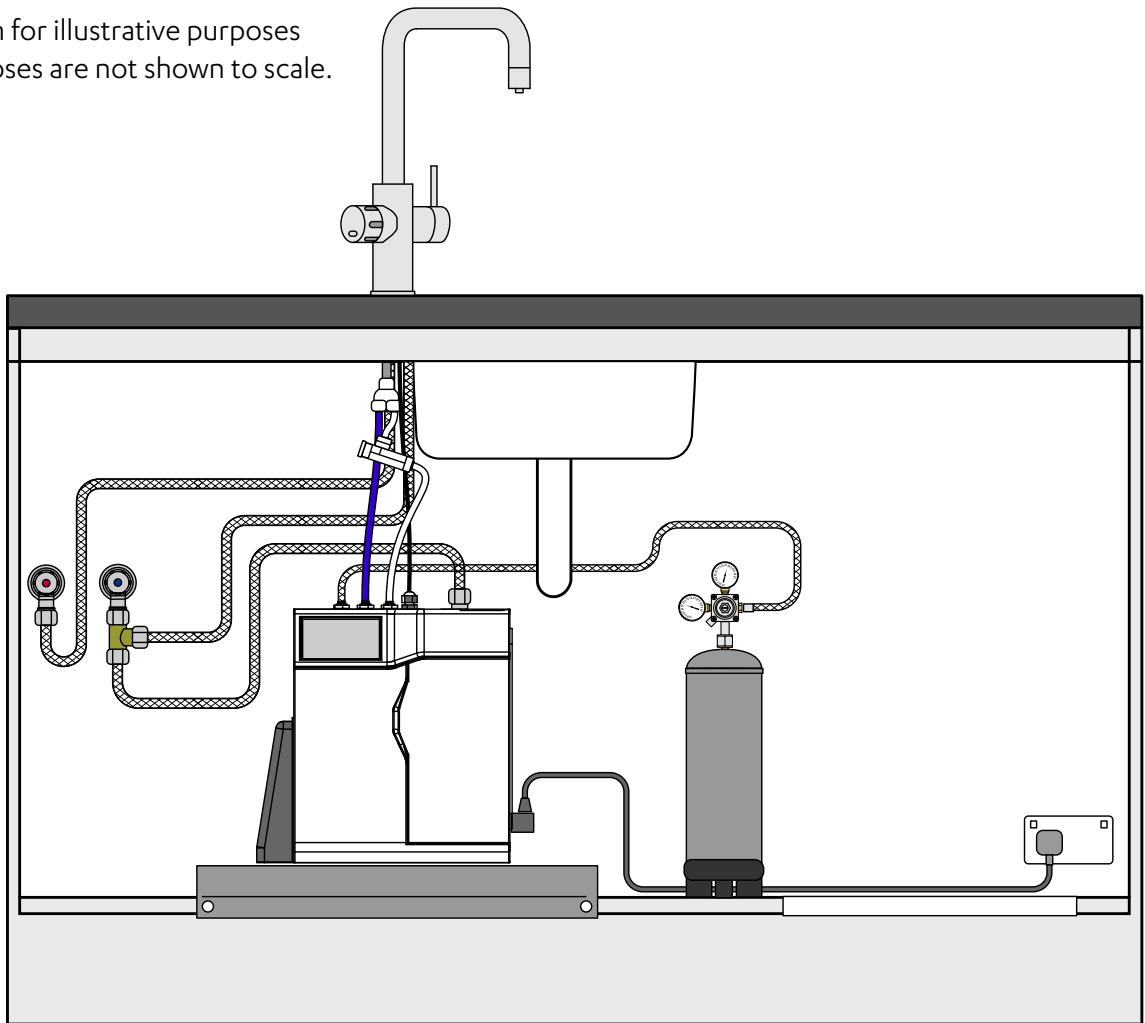

4.8.1 C40 - C100 HydroTap Chilled models

Command Centre connections

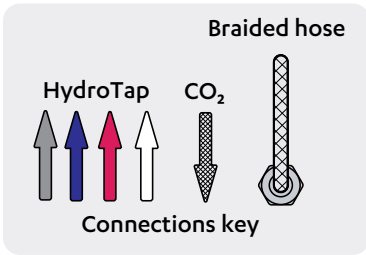

Fit foam insulation (supplied) to the BLUE and WHITE pipes

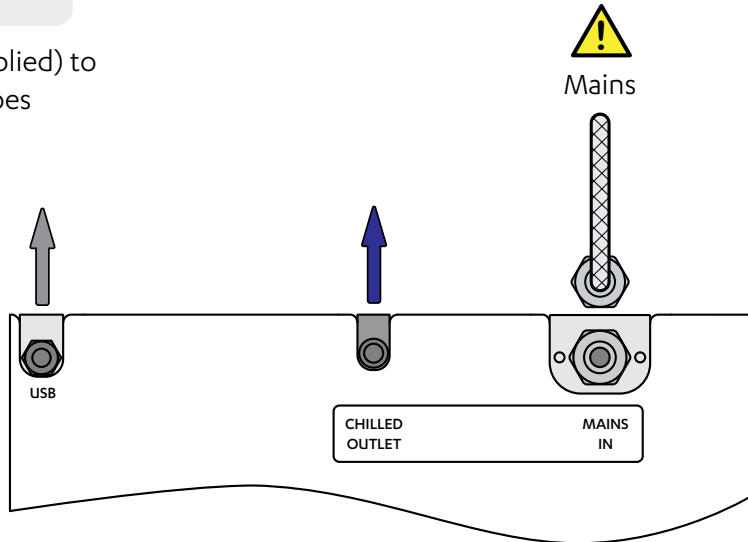

Example installation

Diagram for illustrative purposes only. Hoses are not shown to scale.

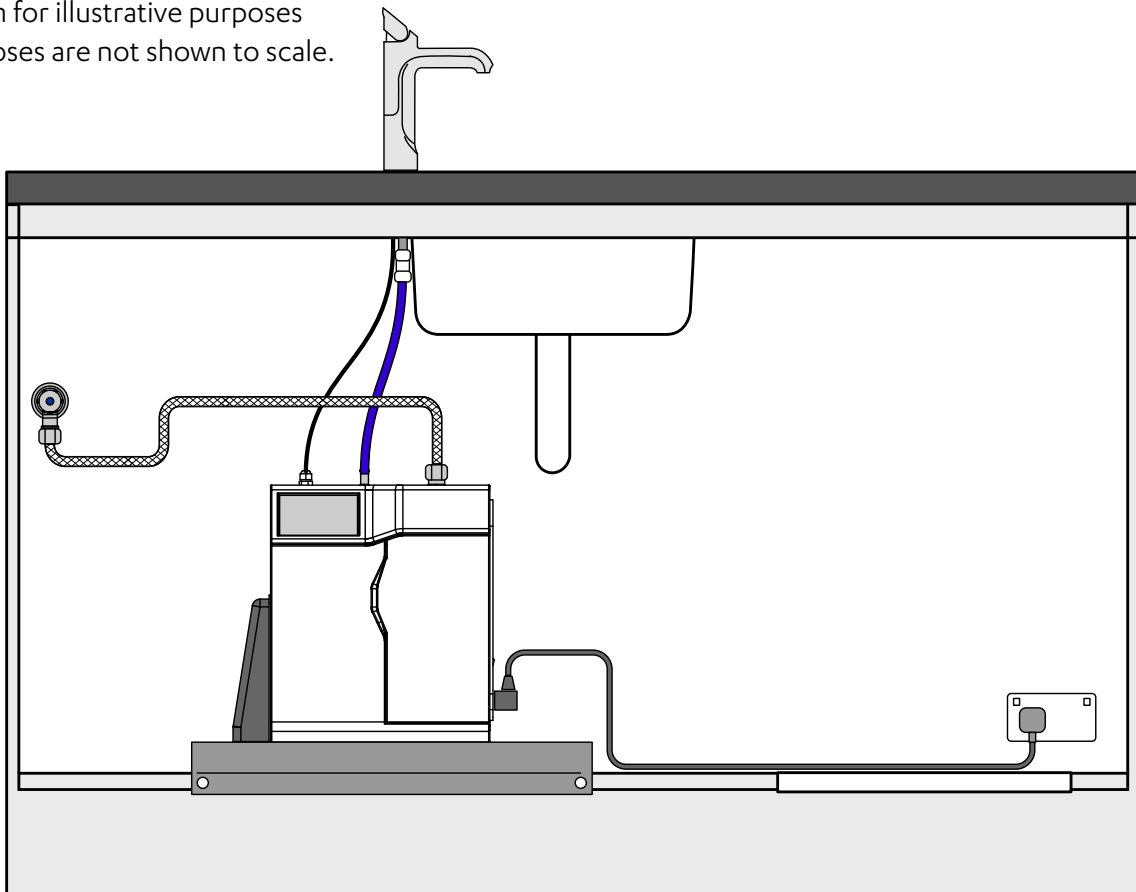

4.8.2 C40 - C100 Chilled and mixed hot & cold models

Command Centre connections

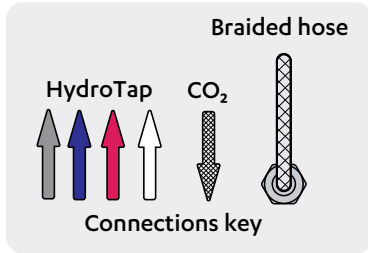

Fit foam insulation (supplied) to the BLUE and WHITE pipes

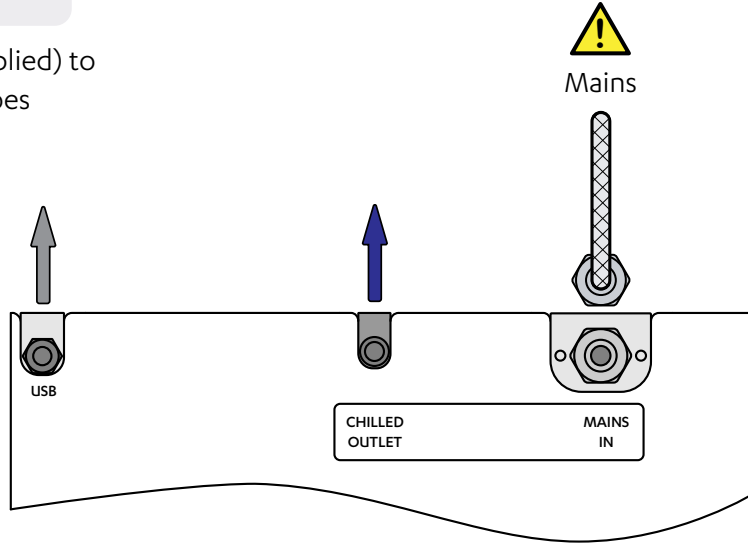

Example installation

Diagram for illustrative purposes only. Hoses are not shown to scale.

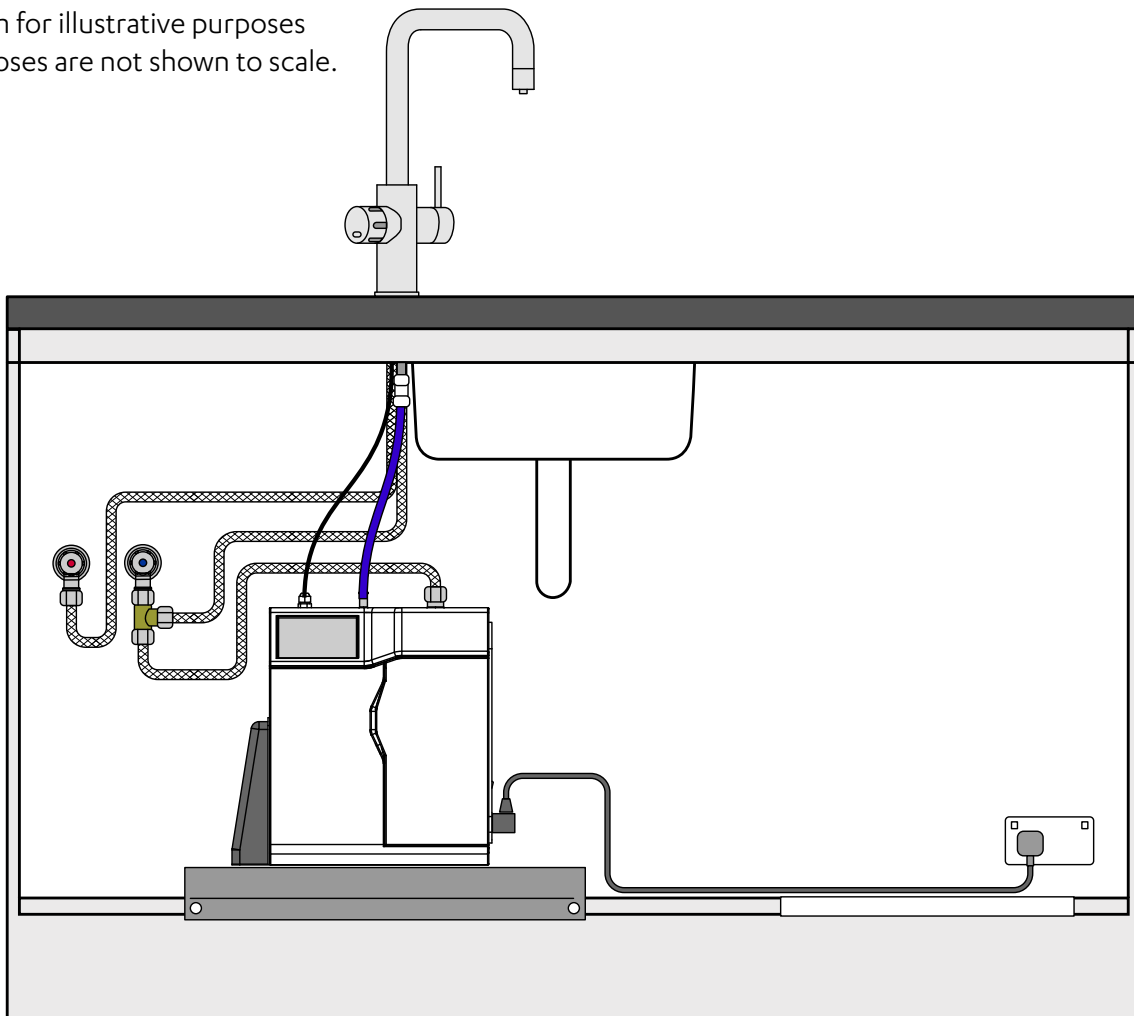

Section 4 Commercial & Residential Command Centre installation

4.9.1 CS Home Chilled and sparkling HydroTap models

Command Centre connections

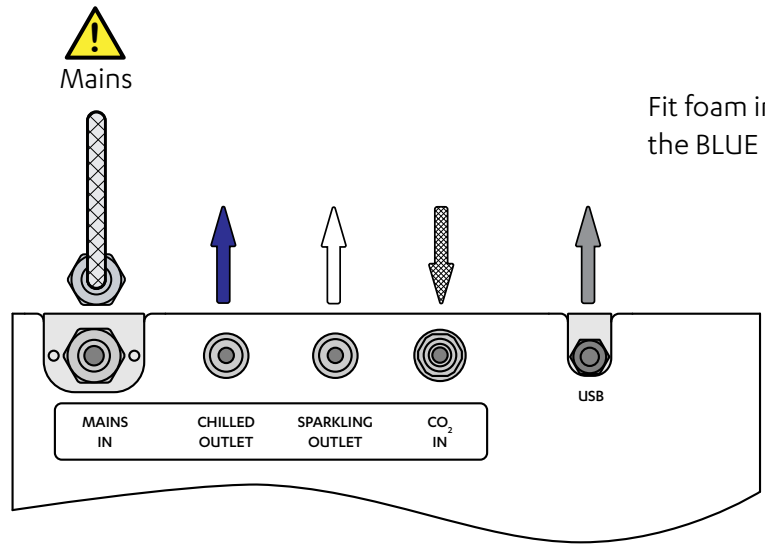
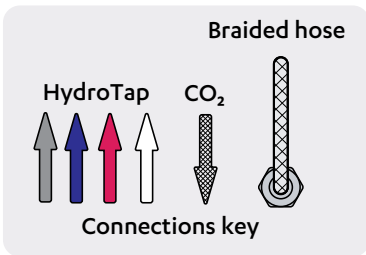

Example installation

Diagram for illustrative purposes only. Hoses are not shown to scale.

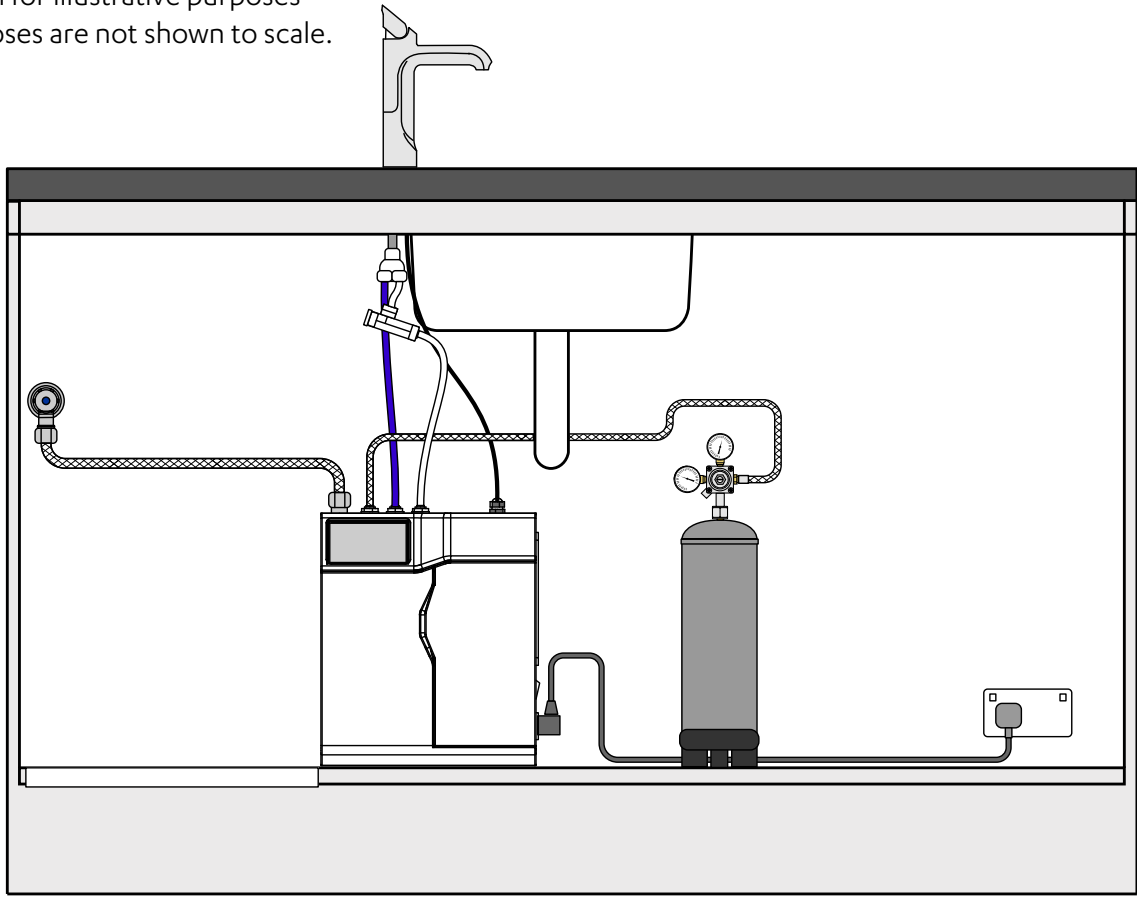

4.9.2 CS Home Chilled, sparkling and mixed hot & cold Command Centre connections

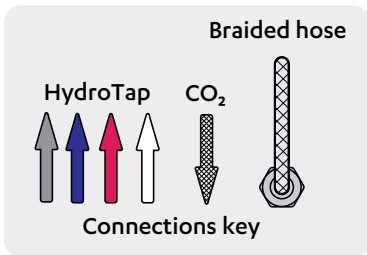

Fit foam insulation (supplied) to the BLUE and WHITE pipes

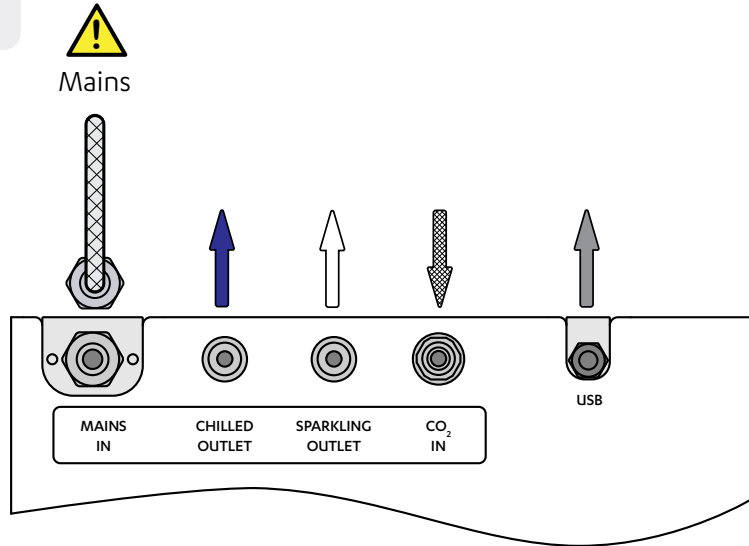

Example installation

Diagram for illustrative purposes only. Hoses are not shown to scale.

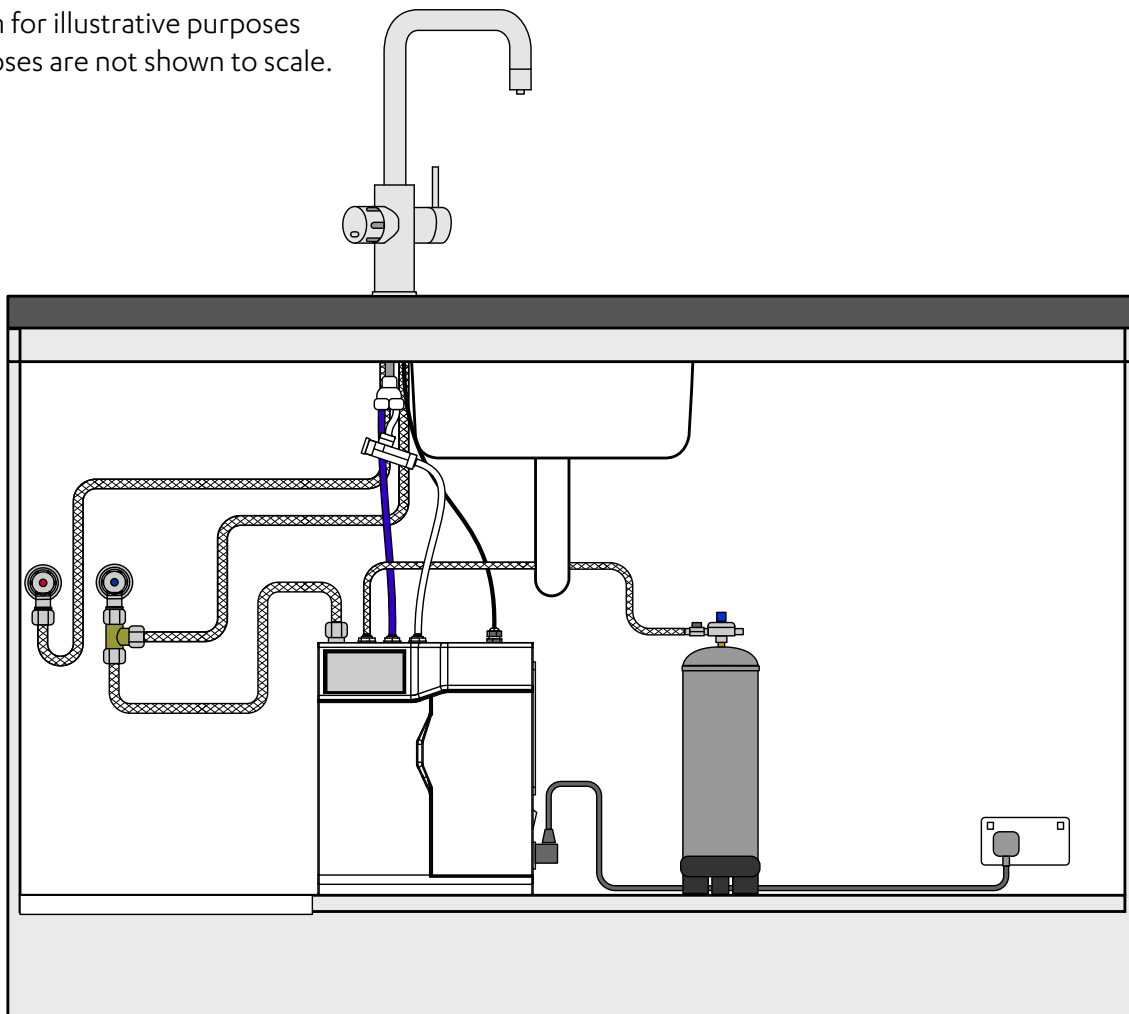

4.10.1 C Home HydroTap chilled models

Command Centre connections

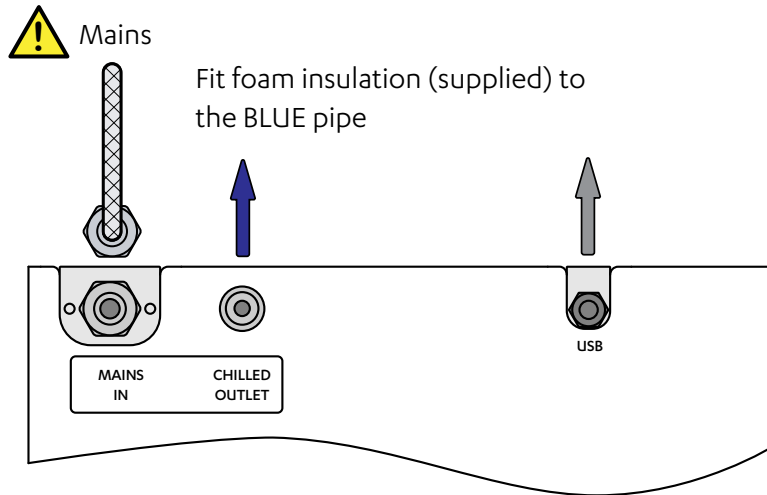
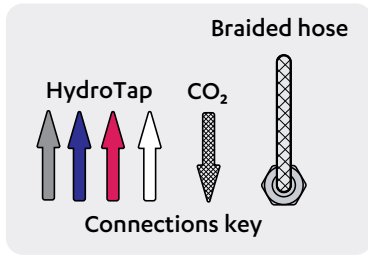

Example installation

Diagram for illustrative purposes only. Hoses are not shown to scale.

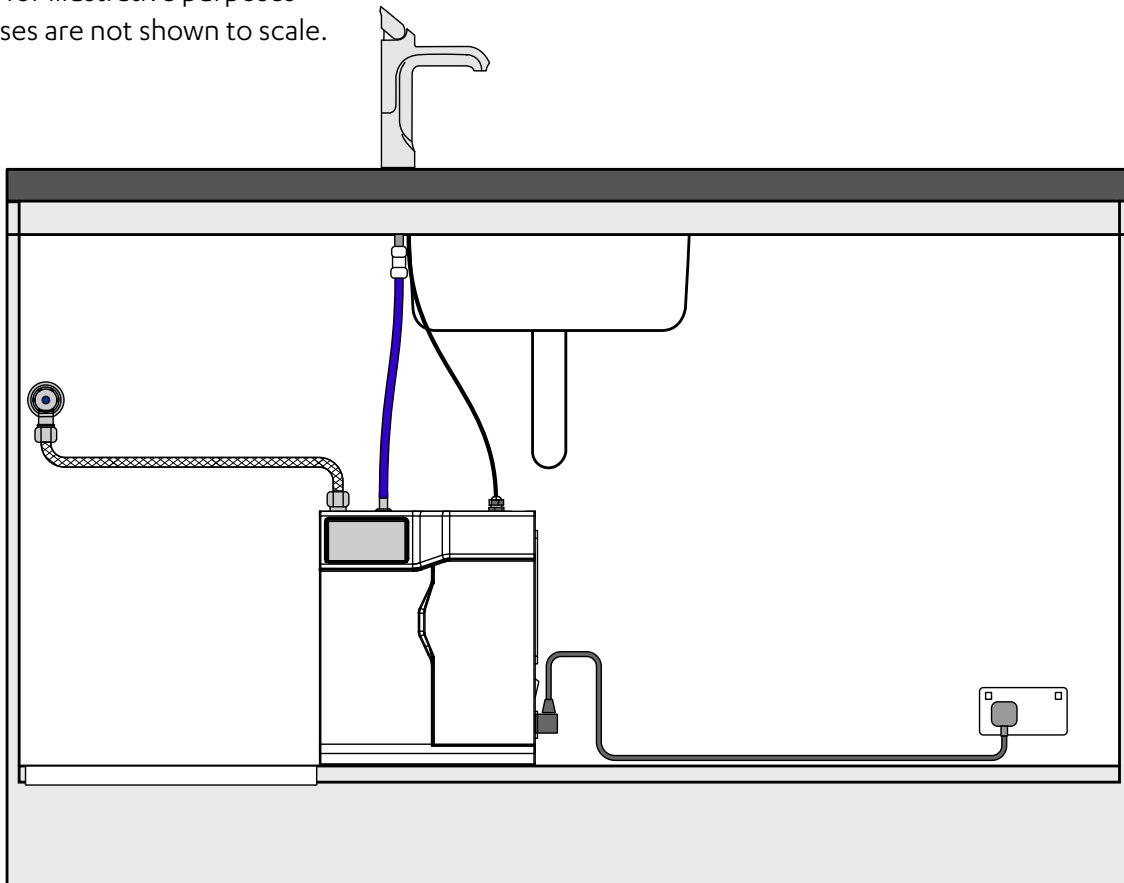

4.10.2 C Home Chilled and mixed hot & cold
Command Centre connections

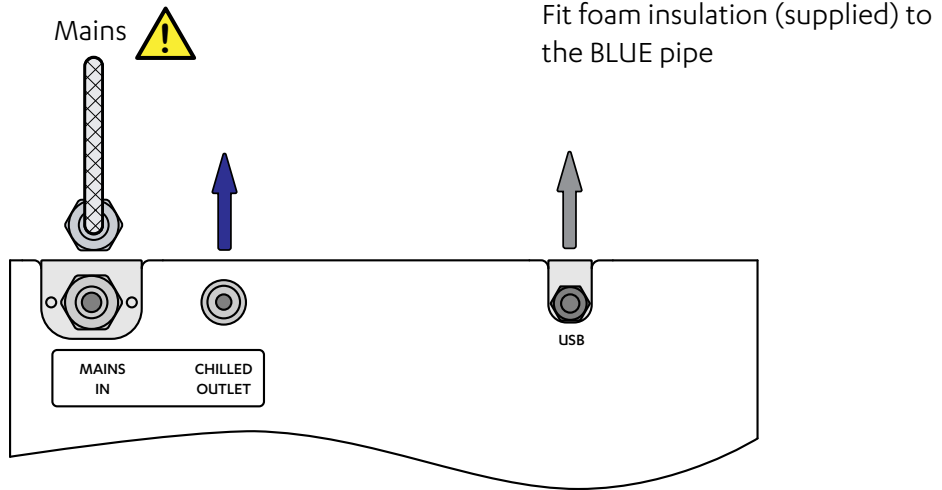
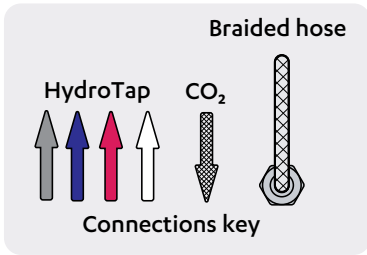

Example installation

Diagram for illustrative purposes only. Hoses are not shown to scale.

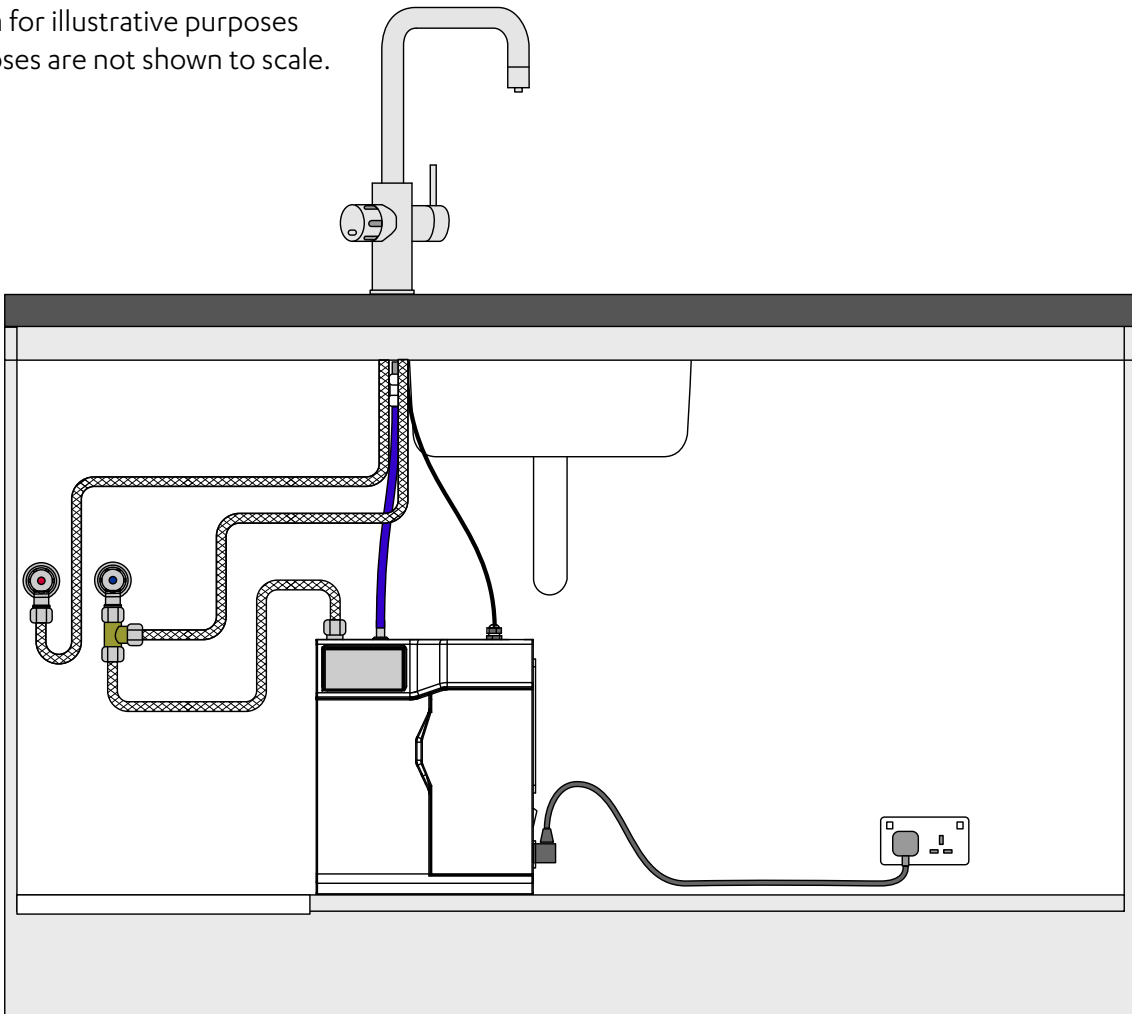

5.1 Generic Commissioning instructions



Read these instructions before commencing Command Centre commissioning, they apply to all installation arrangements.

5.1.1 Install the filter cartridge

- Unpack filter cartridge and remove sanitary cap.
- Write today's date where shown on the label.
- Avoid touching the filter o-rings and filter opening as this may cause bacterial contamination of the cartridge.
- Moisten the o-rings with water.
- Open the filter door on the Command Centre.
- Align the front cartridge label to the left, and push the new cartridge up into the filter head.
- Turn the cartridge a quarter turn anticlockwise until it comes to a complete stop and locks, with the front label facing forward.

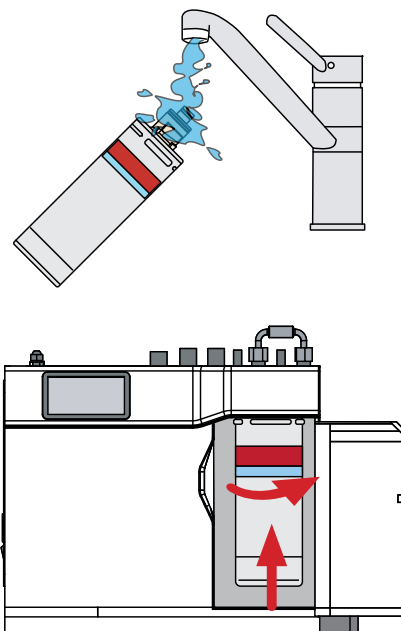

5.1.2 Turn on the supplies

- Connect the mains electrical power cable (for Command Centre and Booster, if fitted) to the supply.
- Turn the power and water on and check for any leaks.
- Familiarise yourself with the operation of the tap, in preparation for use, see the user guide.
- Follow the installation instructions below,
- After commissioning, the system may be customised by selecting further options in the user guide.
- Depending on your location you may need to reset the internal clock. See page [96](#).

5.2 Select the language, date / time & options

- Initial commissioning screen touch Language option.
- Touch the appropriate button to select the language and units of choice.
- Touch the back arrow to go back to previous menu.
- In the previous menu, touch the arrow to begin the commissioning process.

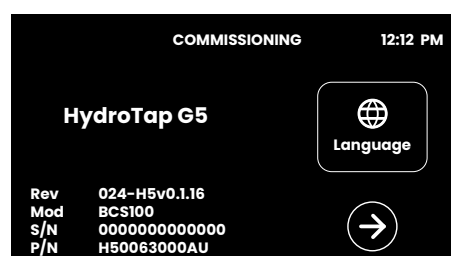

Section 5 Commissioning

- Touch the arrow to continue when ready to start using the HydroTap.
- Touch the date and time, use "-" or "+" to make adjustments. When ready, touch the arrow to continue.
- Select 'Sink / Container' or 'Font' depending on the model, see below.
- Select 'Font' if the HydroTap is mounted on a font.
- Select 'Sink / Container' if the HydroTap is mounted such that the waste water dispenses into a sink, or container.

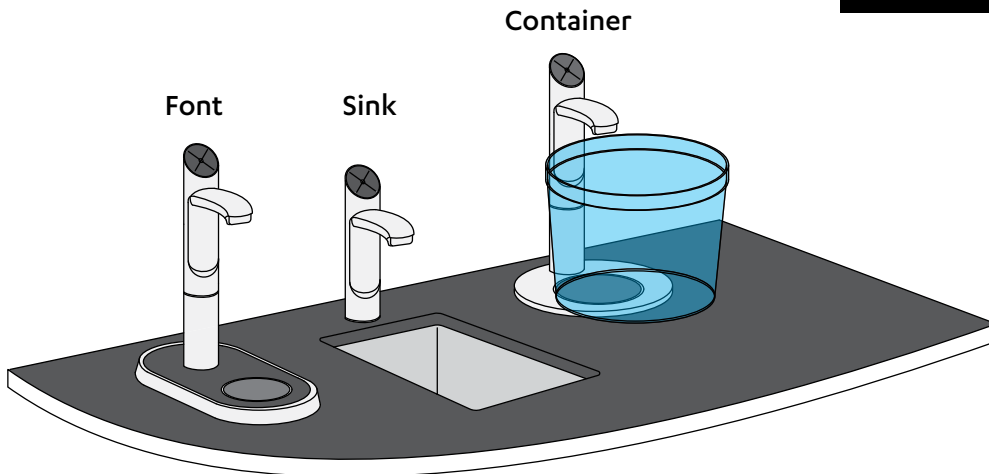
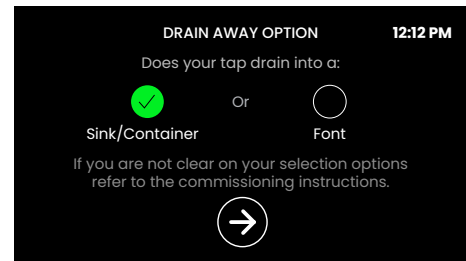
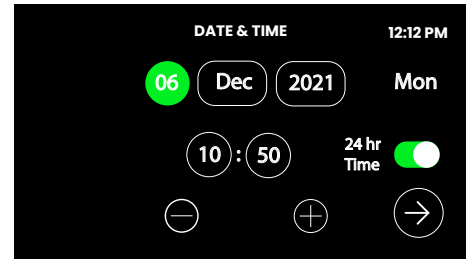
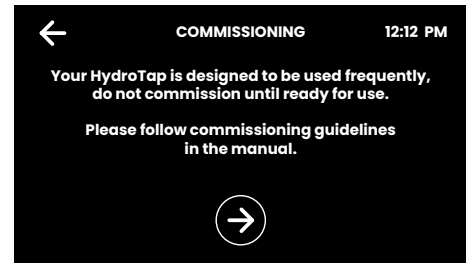

- **Note** This selection will determine if water is dispensed automatically or requires operation of the tap during the tank flush process.
- Touch the arrow to continue.

5.3 Filter flush

- Follow filter flush procedure , page [98](#).

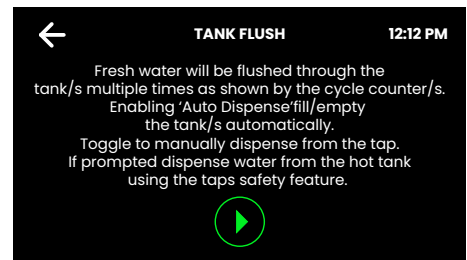
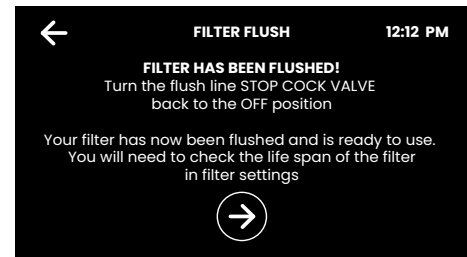
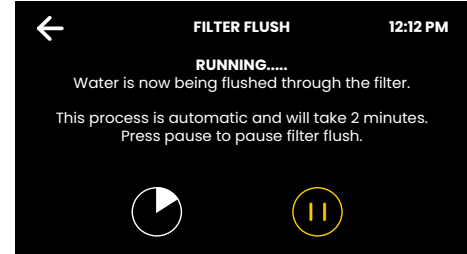
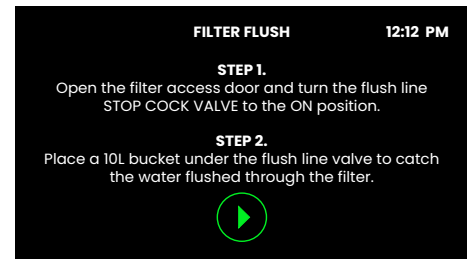

5.4 Tank flush (does not apply to chilled sparkling models)

- Upon first use, the HydroTap water tanks must be flushed with fresh water.
- Follow the instructions to flush the tanks. Dispense water from the tap if instructed.
- Note** Once the tank is full it is necessary to empty each tank until the HydroTap starts to fill again. If the tank is not emptied completely the tank flush will not be complete and will time out. This requires the commissioning process to be started again.
- Note** The 'Auto Dispense' option will be enabled/disabled based on the selection made in the drain away option screen. It can be altered by touching the toggle button.
- Note** Care should be taken if enabling 'Auto Dispense' if the tap drains over a font as it may overflow during the tank flush dispense cycle.
- Make a selection and press Run to start the tank flush.
- At any time press the pause button to pause the tank flush process.
- If 'Auto Dispense' is enabled the tanks will fill and empty automatically except if the water in the hot tank is above 50°C. In this case follow the prompts on the screen to utilise the tap and its safety feature to empty the hot tank.
- If 'Auto Dispense' is disabled the tanks will fill automatically. When prompted use the tap to dispense water and empty the tanks. If the hot tank has water above 50°C then use the taps safety feature to dispense.
- Note** The cycle counter will indicate the flush cycles performed for each tank.

B, BA or BCS Models

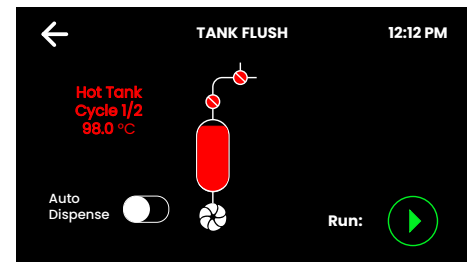

BC Models

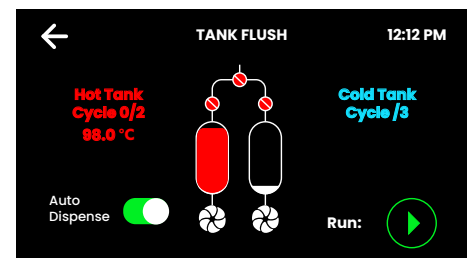

5.5 Boiling calibration (boiling models only)

- Press the green button and the system will start the boiling calibration procedure. This can take up to 10 minutes.
- **Note** For BCS models the compressor will turn on to pre-cool the cold system.

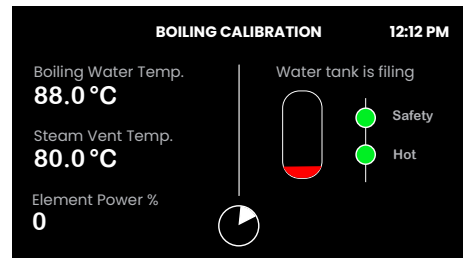
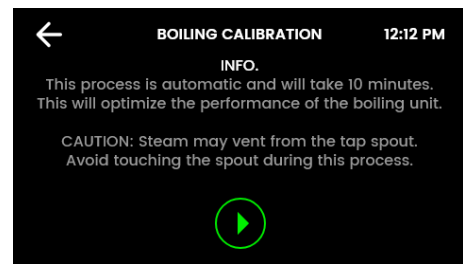

5.6 CO₂ purge (sparkling models only)

- CO₂ life settings should be adjusted for the size of the CO₂ bottle connected. After commissioning is complete refer to section 3.7.3.
- Use the skip arrow to end the CO₂ purge process prematurely if all water has been purged and only gas can be heard coming from the tap.

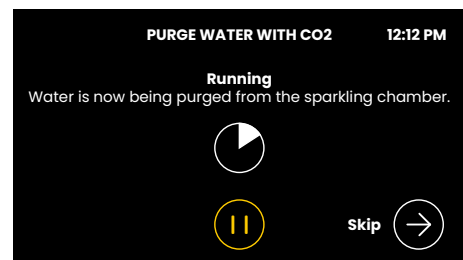
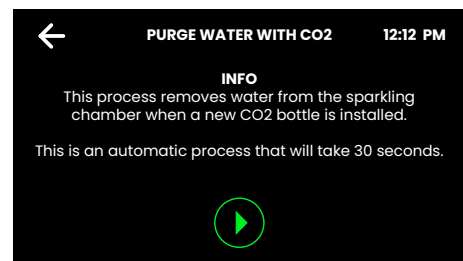

5.7 To enable a booster (when installed)

- Select [YES] to enable the booster.
- Before connecting the power to the booster, water must be run through for a min. of 30 seconds to purge.
- Run the boiling tap for 30 seconds and then allow the tank to refill.
- Connect the power supply.
- Dispense boiling water for 30 seconds and check the booster outlet hose is warm when the boiling water tank is replenishing.

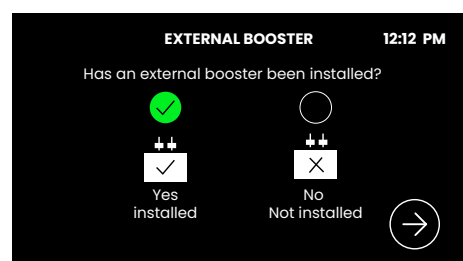

5.8 Carbonation valve adjustment (Sparkling models only)

- Use a 6mm Allen key or a large flat-blade screwdriver to adjust the valve.
- Rotate the adjustment screw anti-clockwise to increase, and clockwise to decrease the flow.
- To measure the set flow rate, use a measuring jug or cup and run the sparkling water for 15 seconds.
- The HydroTap has a default 15 second dispense time, which will help in your flow rate setup.
- Multiply the amount of water dispensed in 15 seconds by 4 to determine the flow rate in litres per minute.
- The optimum flow rate is 1.6 litres per minute (400ml per 15 seconds).
- If the flow rate is adjusted too high, the carbonation tank will be emptied of water, leaving only CO₂ to be dispensed from the tap. This will result in inconsistent flow (spluttering).

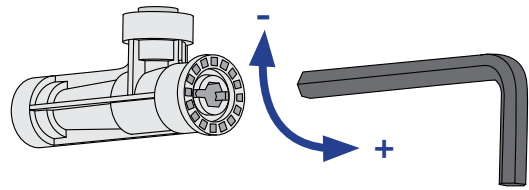

5.9 Safety sensor calibration (Classic boiling models only)

Optional, in cases where light recalibration is required.

Light intensity varies from site to site, therefore it is recommended that a re-calibration be performed at the time of the installation. All direct sunlight must be shaded from the HydroTap G5, during the calibration. This can be achieved by closing any nearby curtains, blinds, etc.

- Shield the HydroTap G5 from direct sunlight.
- In normal operating mode. Turn the power off.
- Pull both tap levers to the forward position.
- Turn the power on.
- The safety sensor will calibrate.
- Return the levers to the neutral position.

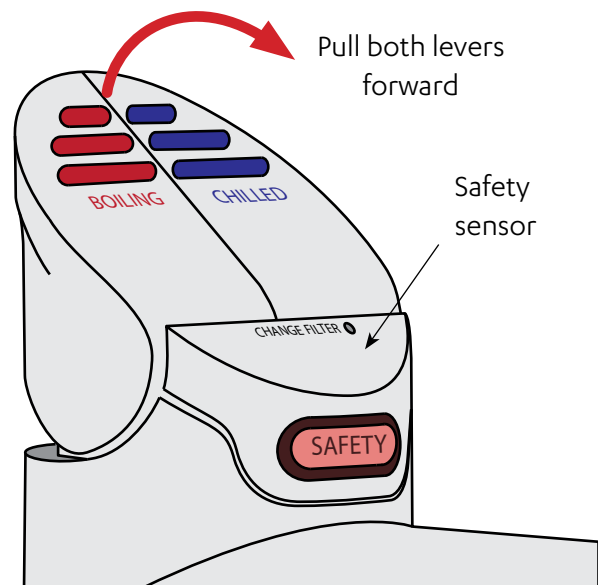

6.1 Service items

- Filters should be replaced at six month intervals for Commercial HydroTaps, and 12 month intervals for Residential HydroTaps.
- CO₂ regulator washers should be replaced annually.

6.2 Trouble shooting table

Fault code	Fault name	Fault trigger
000	Power Board Fault	Internal communication fault
001	Interface Fault	Internal communication fault
004	Water Leak, Isolate Mains	Water detected in the unit due to tank overfill or internal / external leakage.
005	Compressor OverRun	Compressor has been running continuously for an extended time period
006	Water Supply Failure	Water not detected by unit
007	Hot Sensor Open	Internal sensor fault
008	Hot Sensor Closed	Internal sensor fault
009	Cold Sensor Open	Internal sensor fault
010	Cold Sensor Closed	Internal sensor fault
011	Flood Sensor Open	Internal sensor fault
012	Condenser Sensor Closed	Internal sensor fault
013	Condenser Sensor Open	Internal sensor fault
014	Heater Fuse/Driver Fault	Internal component fault
015	Heater Driver Fault	Internal component fault
016	Compr Driver Fault	Internal component fault
017	Hot Sensor Degraded	Internal sensor fault
018	Condenser Overtemp	Temperature of condenser has exceeded its limit
019	A DC Pump is faulty	Internal component fault
020	Steam too cool	Boiling calibration error
021	Steam Sensor Open	Internal sensor fault
022	Steam Sensor Closed	Internal sensor fault
023	Over Steamed	Excess steam detected
024	Hot Tank Overfilled	Hot tank has over filled
025	Comp Fuse/Driver Fault	Internal component fault
027	Boil dry protection	Heating protection device has activated

- Call Zenith for Advice and assistance (see contact details page [110](#)).

Section 7 End of life disposal



The use of this crossed out wheeled bin logo indicates that this product needs to be disposed of separately to any other household waste.

Within each of the European Union member countries, provisions have been made for collection and recycling of unwanted electrical and electronic equipment. In order to help preserve our environment we ask that you dispose of this product correctly.

User Guide



Zenith HydroTap® G5

Models :
All G5 systems



Section 1 Safety

Explanation of symbols [84](#)
 Before you start [84](#)

Section 2 Using the HydroTap G5

HydroTap range styles..... [85](#)
 Classic Plus HydroTap..... [86](#)
 Touch-Free Wave HydroTap [87](#)
 Arc , Cube and Celsius HydroTaps..... [89](#)
 Classic HydroTap..... [90](#)
 Mixer Taps [91](#)

Section 3 Command Centre Screen

Section 3.1 How to use the Command Centre screen [92](#)
 Section 3.2 Screen guide [92](#)
 Section 3.3 OFF screen [93](#)
 Section 3.4 Home screen [93](#)
 Section 3.5 Main menu [95](#)
 Section 3.6 General settings menu (Language, Date/time, Network) [96](#)
 Section 3.7 System settings menu [97](#)
 Section 3.7.1 Filter & flush [98](#)
 Section 3.7.2 Temperature [101](#)
 Section 3.7.3 CO₂ [103](#)
 Section 3.7.4 Dispense times..... [105](#)
 Section 3.7.5 Light sensor [105](#)
 Section 3.7.6 Quiet mode [106](#)
 Section 3.7.7 Advanced settings [107](#)
 Section 3.7.8 System restart..... [109](#)
 Section 3.8 Safety and security (Boiling safety, Passcode protect) [109](#)
 Section 3.9 Energy saving (Sleep mode, On/off timer, Energy use) [111](#)
 Section 3.10 Info & logs (Filter logs, System faults, About system)..... [114](#)
 Section 3.11 Product serial number [114](#)
 Section 3.12 Register product [115](#)
 Section 3.13 Service Technician..... [115](#)

Section 4 User maintenance

Section 4.1 Filter maintenance [116](#)
 Section 4.1.1 Internal filter change [116](#)
 Section 4.1.2 Air inlet filter [118](#)
 Section 4.2 Cleaning..... [118](#)
 Section 4.3 The CO₂ cylinder & regulator (Identifying the components, Changing the cylinders).... [119](#)

Contact Us

Contact details [123](#)

Explanation of symbols



Read the instructions



WARNING



DANGER
Electric shock



DANGER
Hot surface

Before you start



Read the **IMPORTANT SAFETY INSTRUCTIONS & WARNINGS AND REGULATORY INFORMATION** at the start of this document.



Read and use the instructions and safety information supplied with individual kit components for a safe installation.

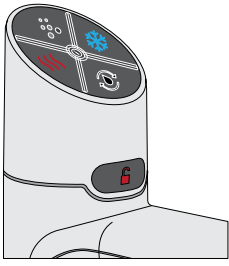

Classic Plus, Elite Plus

See page [86](#)

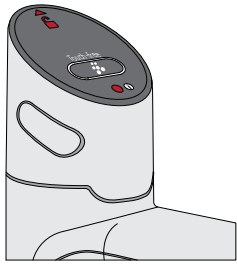

Touch-Free Wave

See page [87](#)

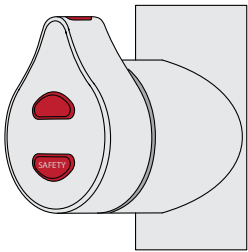

Arc, Cube and Celsius

See page [89](#)

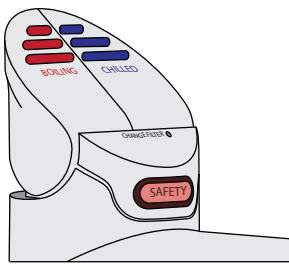

Classic

See page [90](#)

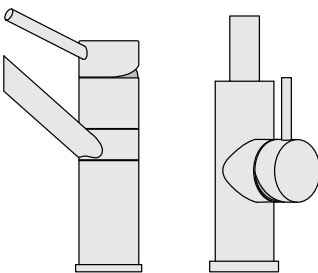

HydroTap Mixer Taps

See page [91](#)

Note Not all taps are available in all markets

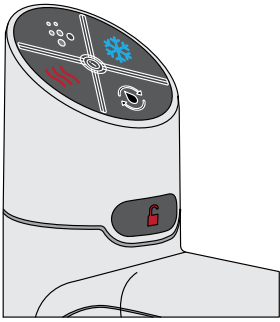

Controls Press to dispense

Simply press to dispense chosen water type

Safety lock

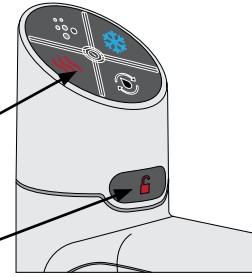

Lights

Light modes



ON
Safety lock on
OFF
Safety lock off

Info.

Safety lock

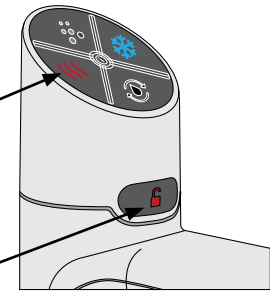

ON
Ready to dispenser.
FLASHING SLOWLY
Water temperature is not at set point.
FLASHING QUICKLY
System fault.



ON
Bottle fill enabled
FLASHING
Change filter

Dispense options



Press the icons to dispense water choice.



+



Boiling



Chilled



Sparkling



Bottle fill
(then press
water
choice)

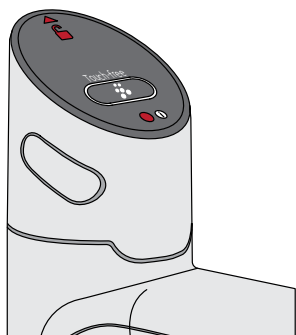

Controls Touch-free sensors on the tap top, back and sides.



Safety sensor (at back)
Dispense sensors

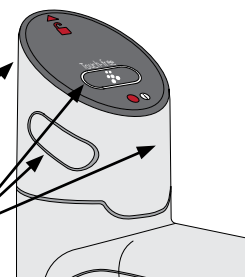

Clearance requirements

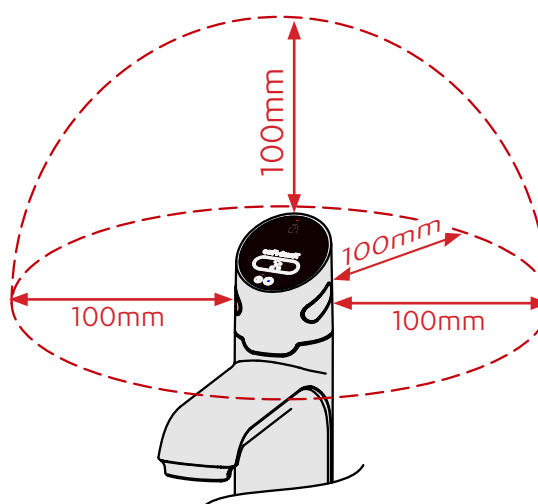

Lights - Light modes



RED Boiling & safety sensors activated, water dispensed.

BLUE Chilled sensor activated, water dispensed.

WHITE Sparkling sensor activated, water dispensed.

PURPLE Lock mode on (when tap is idle).

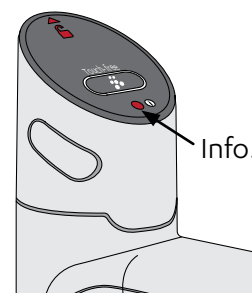

Flashing RED Sensor activated incorrectly; hand may be too close to sensor, sensor has been touched or covered.

WHITE / BLUE / RED Cycling 5 to 10 seconds

Filter needs replacing, CO₂ warning (G5), unit is in an error mode (refer to Command Centre screen).

WHITE Flashing rapidly

Sensors are calibrating for 10 seconds when power is first applied to the tap.

USER GUIDE

Section 2 How to use the Touch-Free Wave HydroTap

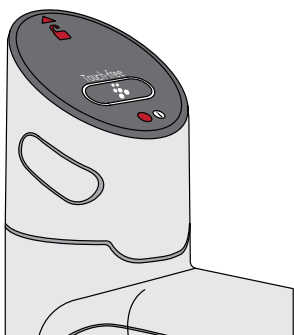

Dispense options



Sensor range 1 - 4cm.

To dispense, hold hand within range of the sensors. The tap will not operate if the sensors are touched.

Tap will not operate and light will flash if sensors are touched or if your hand is too close.

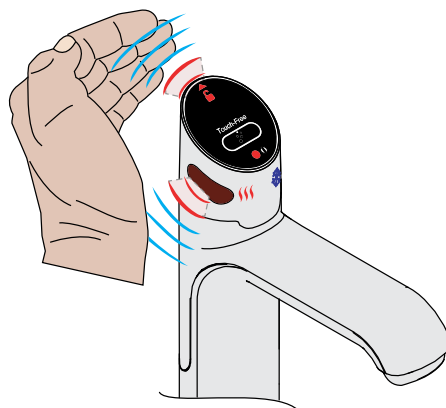

Side + Rear sensor:
Bottle fill
(timed dispense)

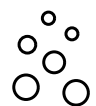
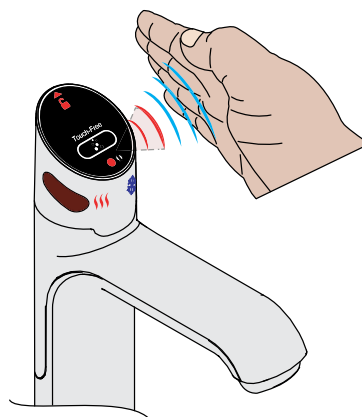

Top + Rear sensor:
Bottle fill
(timed dispense)

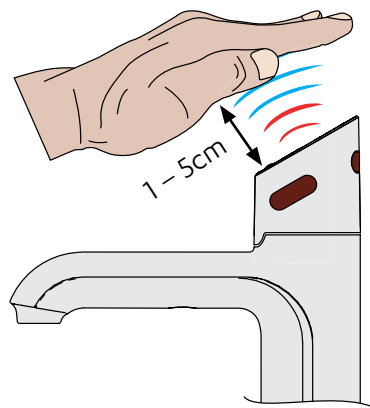

Note Touch-Free Wave will not function below 10°C.

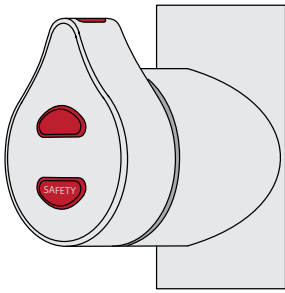

Controls

Bottle fill (timed dispense)

Manual dispense

Indicator displays system status.

Select touch to select water type.

Safety To dispense boiling water touch twice (while flashing) when safety lock is on.

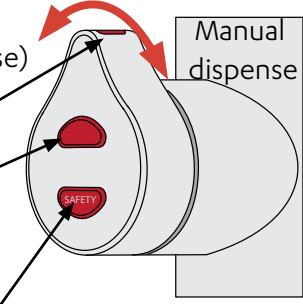

Lights

Light modes

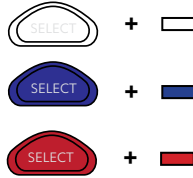

Indicator

Select

Safety

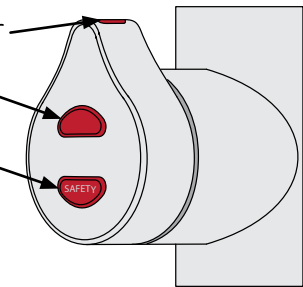

ON

Ready to dispense.

ALL LIGHTS FLASH CONTINUOUSLY

System fault, refer to Command Centre LCD (HydroTap will not function).

RED OR BLUE LIGHT FLASHES

Fault (HydroTap still functions), refer to Command Centre LCD screen.



ALL LIGHTS FLASH EVERY 10 SECONDS

Filter change due.



SAFETY LOCK ON

Dispense options



Boiling

Chilled

Sparkling

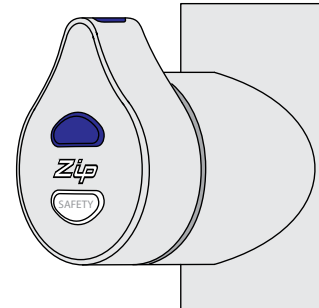

USER GUIDE

Section 2 How to use the Classic HydroTap

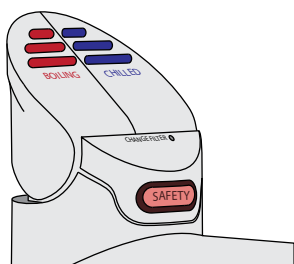

Controls

Push for manual dispense.
 Pull for bottle fill
 (timed dispense).



Lights

Boiling ready
 Chilled / sparkling ready

Light modes



ON active
 OFF inactive



ON

Ready to dispense.

FLASHING SLOWLY

Water temperature is not at set point.

FLASHING QUICKLY

System fault.

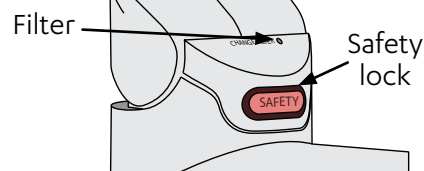

○ FILTER

- OFF
Filter within lifespan.
- FLASHING SLOWLY
Change filter.

Dispense options



Use boiling, chilled, sparkling, or ambient lever to dispense your water choice.



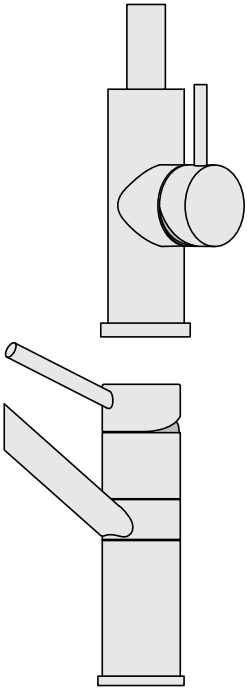

Controls mixed water

- Hot
- Cold

Lift and rotate the lever to dispense mixed warm water.

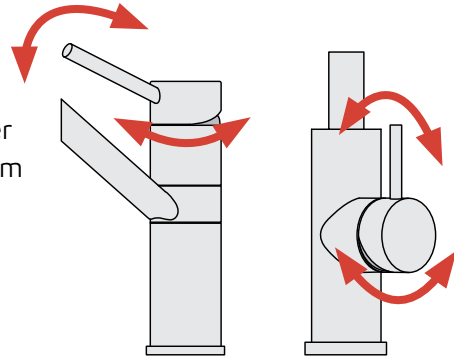

3.1 How to use the Command Centre screen

- The Command Centre has a colour touch screen liquid crystal display.
- The display consists of icons, buttons and fields which can be changed by simply touching the buttons and icons.
- Navigate to the required screen. Here's an example :

3.2 Screen guide

- The display consists of over 150 individual menus and screens.
- Navigate to the required screen on this side of the page, here's an example :

Set the language

- Touch the 'top left' icon to navigate to the main menu.

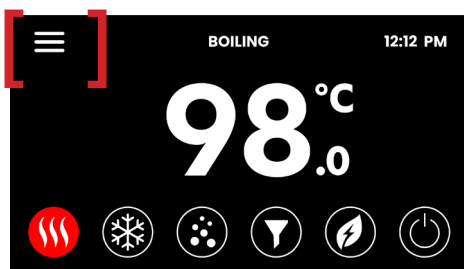

- Then touch the general settings icon to navigate to the general settings menu.

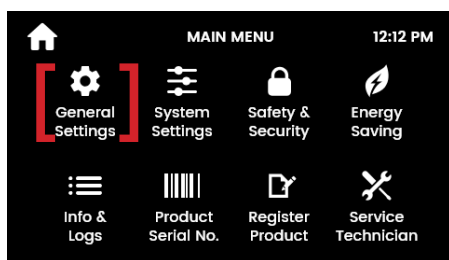

- Touch the language icon to navigate to the language screen.

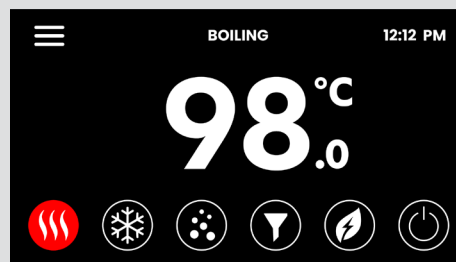
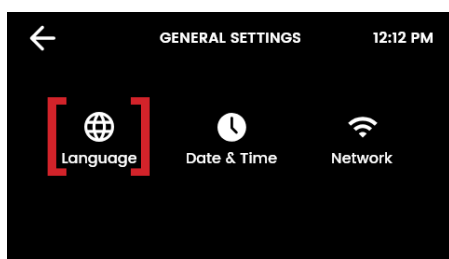

- The settings are made on this side of the page.

Language Set the language

- Touch the relevant button to choose the language.

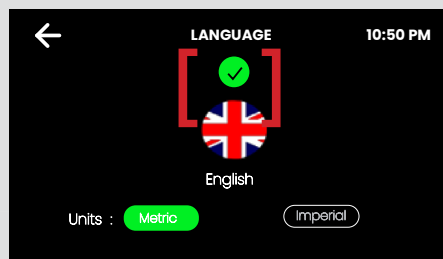

- Tips and guidance are written on both sides of the page to help you navigate and understand the options.

- To go back.

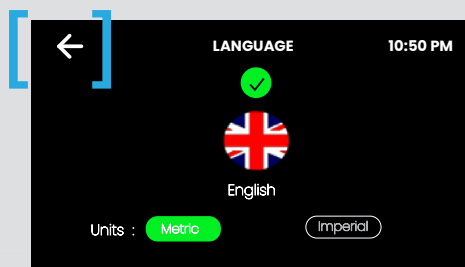

- To go to the home screen.

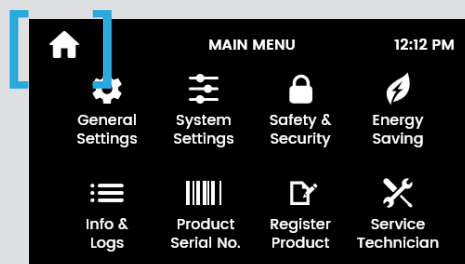

3.3 OFF screen

- Touch the power button to turn the Command Centre ON or OFF.
- The LCD screen visually shows OFF when it is non-operational.
- You will hear the sound of an internal “click” as the HydroTap Command Centre turns ON or OFF.

3.4 Home screen

Status screens shown here are representative and may vary.

- Use the home screen to monitor the status of your HydroTap.
- Touch each icon to view the system status.
- The screen turns OFF after 5 minutes of non-use.
- Touch the screen to reactivate.

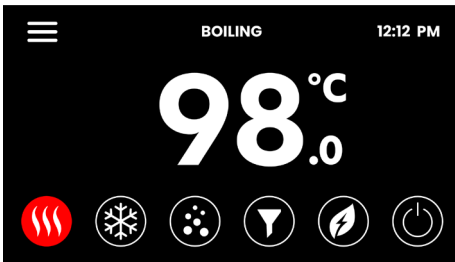

- When the CO₂ cylinder has approximately 20% remaining prepare a replacement cylinder.

OFF screen



Home screen

Boiling temperature set point

Boiling models

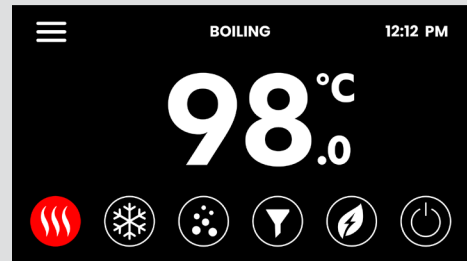

Chilled temperature set point

Chilled models

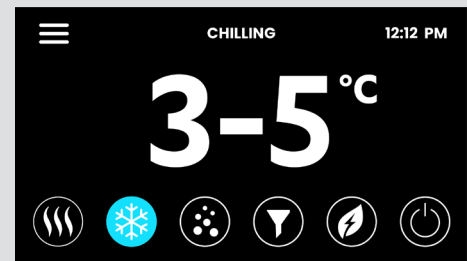

CO₂ gas remaining Sparkling models

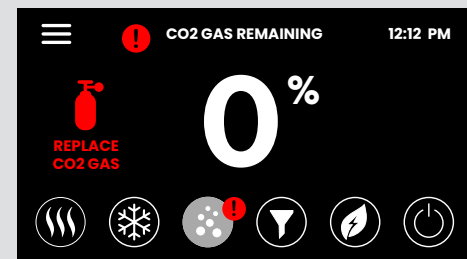
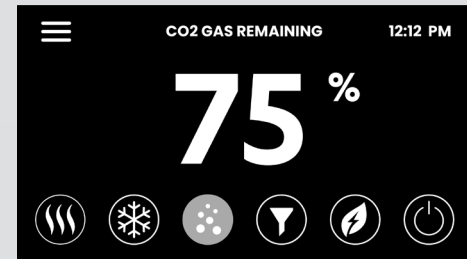

3.4 Home screen continued

- A warning icon illuminated when the filter needs to be replaced. See page [116](#).
- Navigate the screen icons, buttons and fields to set up energy saving features, Energy saving menu , see page [111](#).

Filter life remaining

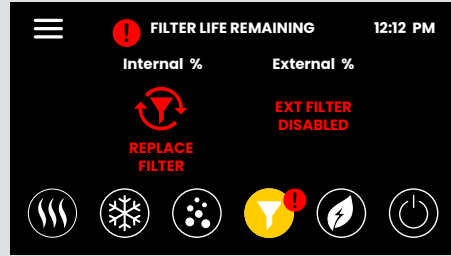
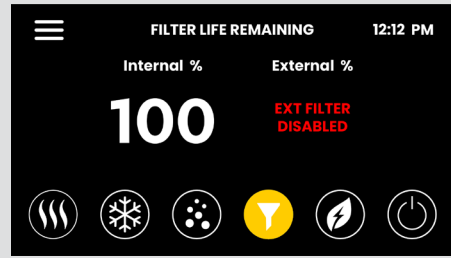

Energy saving settings

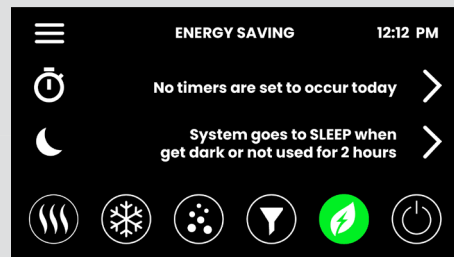

3.5 Main menu

Use the Main menu to configure your HydroTap and access features and settings. Touch each icon to access further options.

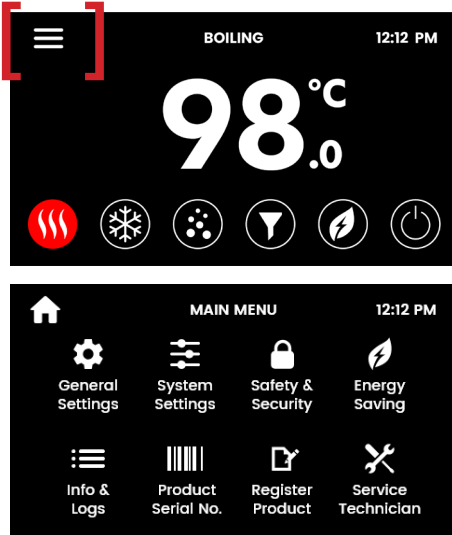

3.6 General settings

see page [96](#)

Language.
Date & time.
Network.

3.7 System settings

see page [97](#)

Filter.
Temperature.
CO₂.
Dispense time.
Light sensor.
Quiet mode.
Advanced settings.
System reset.

3.8 Safety & security

see page [109](#)

Boiling safety.
Password protect.

3.9 Energy saving

see page [111](#)

Sleep mode.
ON OFF timer.
Energy Use.

3.10 Info & logs

see page [114](#)

Filter logs.
System faults.
About system.

3.11 Product serial number

see page [114](#)

3.12 Register product

see page [115](#)

QR code to sign up for
HydroCare.

3.13 Service Technician

see page [115](#)

For certified technician to use
only (password required).

3.6 General settings

Use the Main menu to configure your HydroTap to access features and settings.

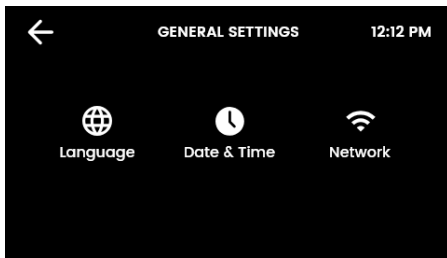
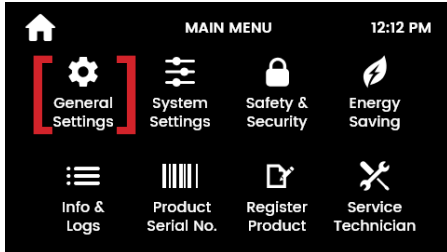

Network

Connect to Wi Fi (selected models)

Language Set the language

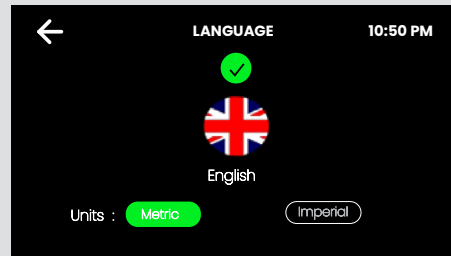

Date and time Set the date and time

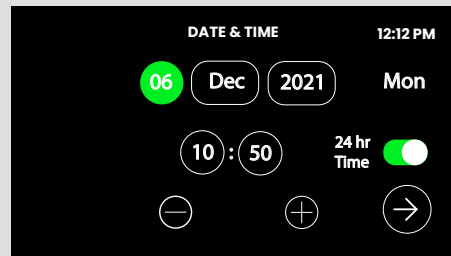

Network

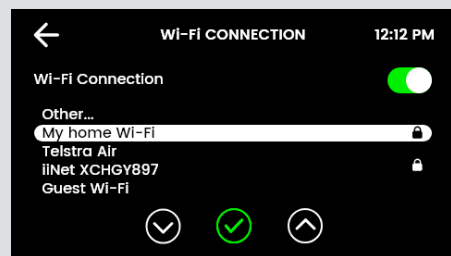

3.7 System settings menu

Configure your HydroTap to suit your needs. Navigate to system settings screen for all system settings.

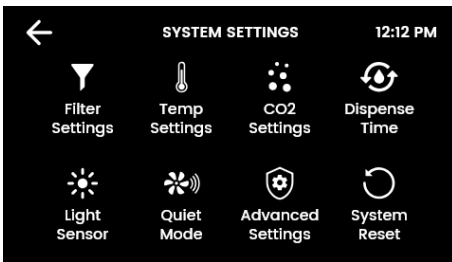
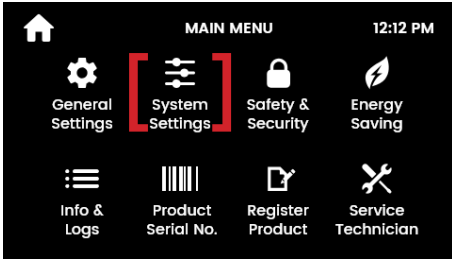

3.7.1 Filter & flush	See page 98
3.7.2 Temperature	See page 101
3.7.3 CO ₂	See page 103
3.7.4 Dispense time	See page 105
3.7.5 Light sensor	See page 105
3.7.6 Quiet mode	See page 106
3.7.7 Advanced	See page 107
3.7.8 System reset	See page 109

3.7.1 Filter settings

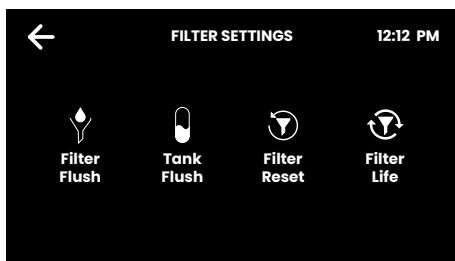
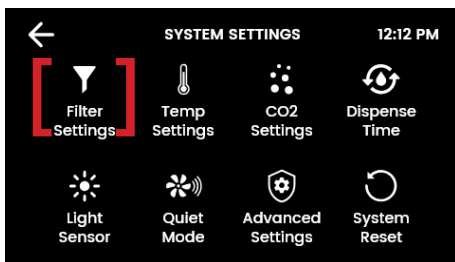
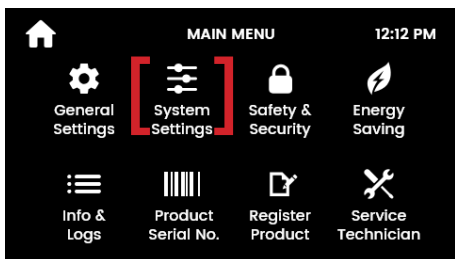

- Follow the steps on-screen to flush the filter.
- Place a cloth or towel under the filter cartridge to catch any water that may spill.
- Open the flush line tap.
- Once the filter flush is finished, close the flush line tap.
- Wipe up any spills.
- Close the door to secure the appliance.
- Reset the filter counter.

Filter flush

- Use Filter Flush during commissioning of a new installation, and after every filter change. see page 116 for filter change instructions.

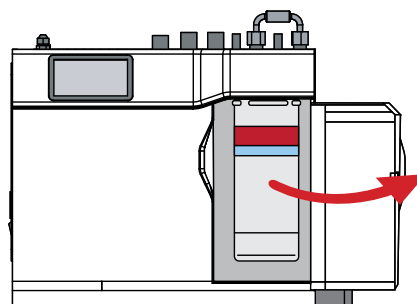

- Open filter door.

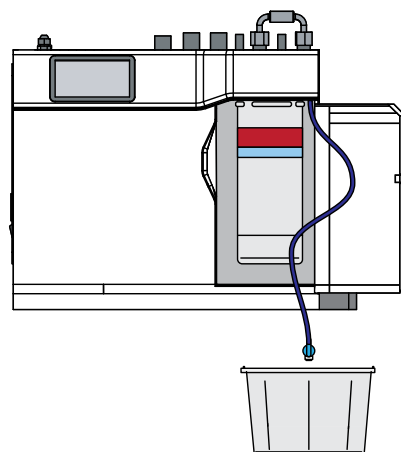

- Uncoil flush line.
- Direct flush line into bucket.

- Open flush line tap, shown open adjacent.

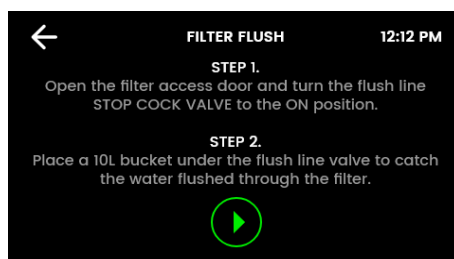
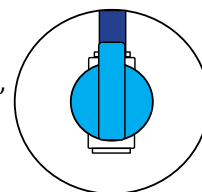

- Start filter flush.

3.7.1 Filter settings

- Tank flush (does not apply to chilled sparkling models)
- For detailed tank flush instructions, see Section 5 Commissioning page [77](#).

Filter flush continued

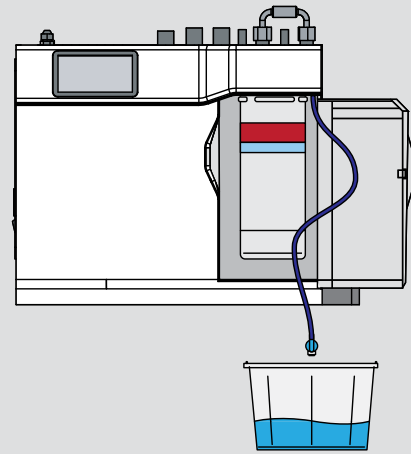

- Flush 10 litres through.

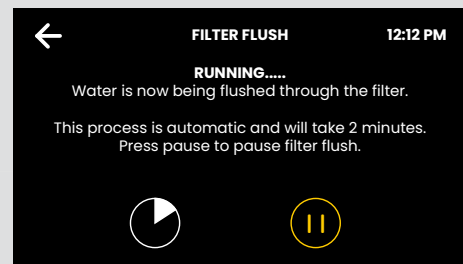

- Stop flush , coil up flush line, close flush line tap.

- Flush line tap closed.

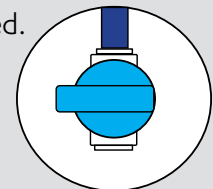

- Return flush line to filter compartment & close door.
- Reset the filter counter (see page [100](#)).

Tank flush

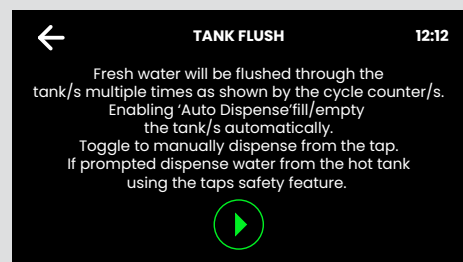

3.7.1 Filter settings

- Press upper internal or external filter button.
- Press lower button to confirm.

Filter Reset

- Reset the filter counters after filter replacement and flush.

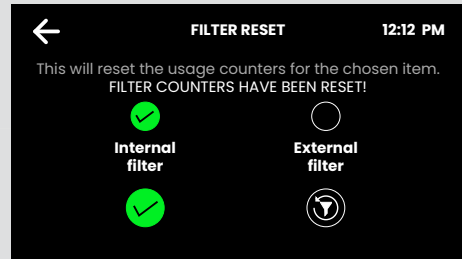
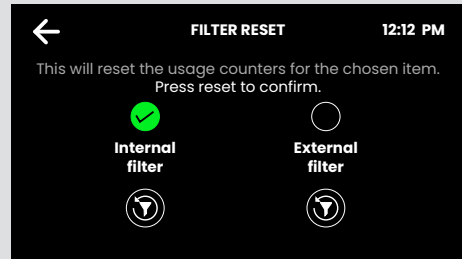
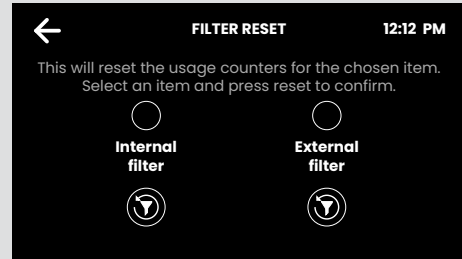

- Select internal/external filter and edit the filter life (months or litres) and actual usage (days or litres).
- When usage exceeds the filter life, the tap lights and screen will indicate to change the water filter.
- Default filter life settings:
12 months, 4000L (residential);
6 months, 6000L (commercial).

Filter Life

Internal filter

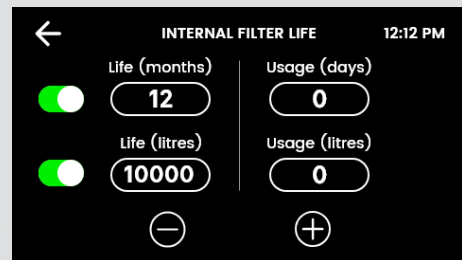

External filter

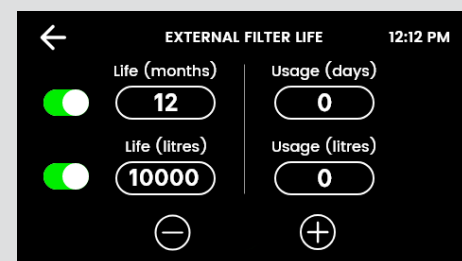

3.7.2 Temperature settings

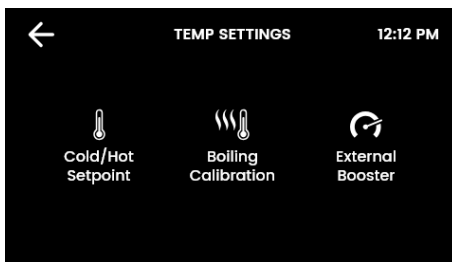
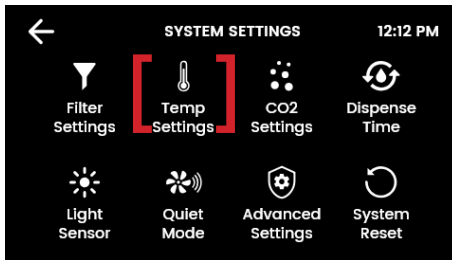
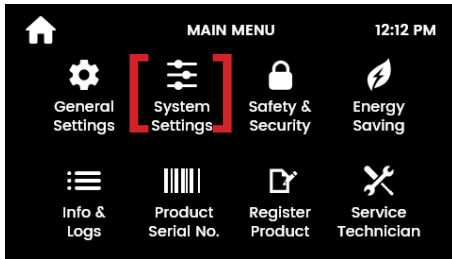

Boiling / Chilled set point

- Adjust as required.

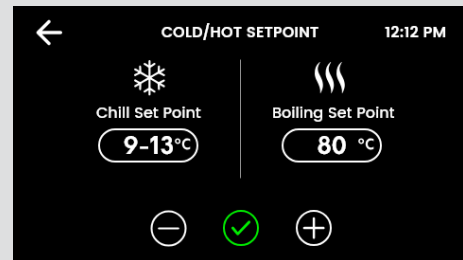

Chilled models

- Default set point: 5-9°C Commercial, 6-10°C Residential.
- Scroll to select alternatives.

Sparkling models

- Default set point: 3-6°C Commercial, 3-7°C Residential.
- This set temperature is fixed, for sparkling optimisation.

Boiling models

- Default set point: 98°C Set point range: 68-100°C.
- Operation: Within 1-2°C of set point.
- Note** Boiling water delivery rate will be affected with a higher temperature setting. Up to 6% less energy in standby is consumed with a 98°C set point, rather than 100°C.

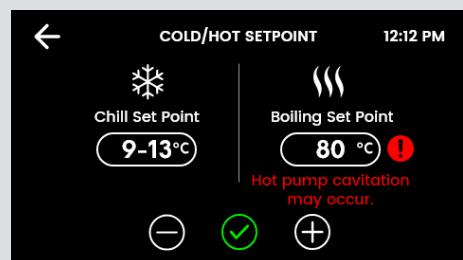

- A warning icon will appear when setting boiling set point temperatures that are subject to pump cavitation.

3.7.2 Temperature settings continued

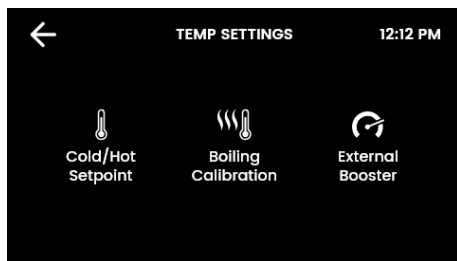
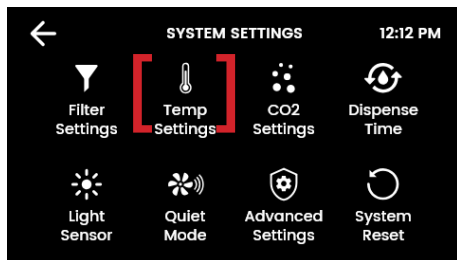
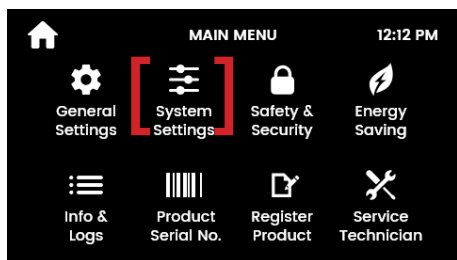

- For selected commercial Boiling models, an external booster is supplied or may be purchased as an upgrade to increase Boiling capacity.

Boiling calibration

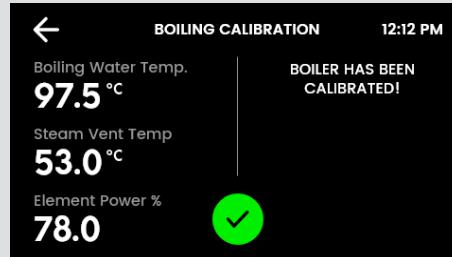
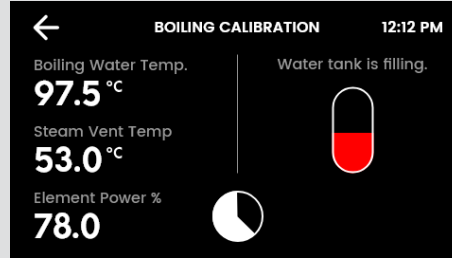
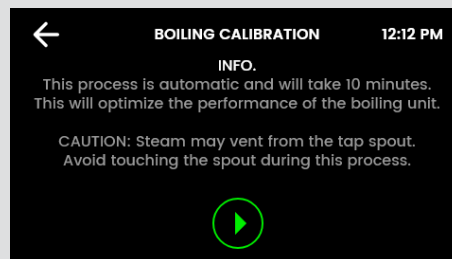

- Take care during boiling calibration as hot steam may vent from the tap spout.
- On start-up, the HydroTap self-calibrates or go to this menu to recalibrate..
- Calibration will take around 10 minutes.

External booster

- Ensure the correct selection is made, for optimum performance.

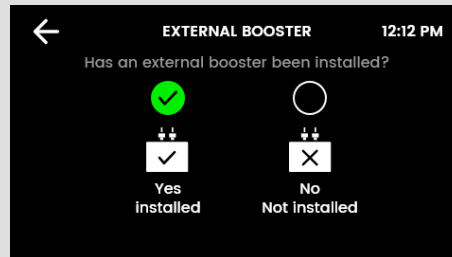
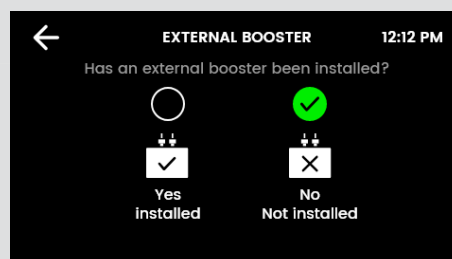

3.7.3 CO₂ settings

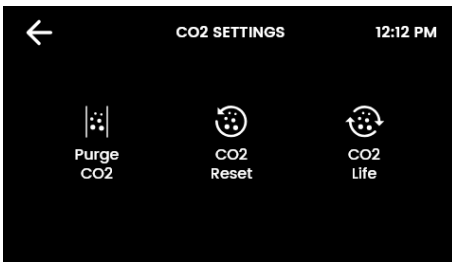
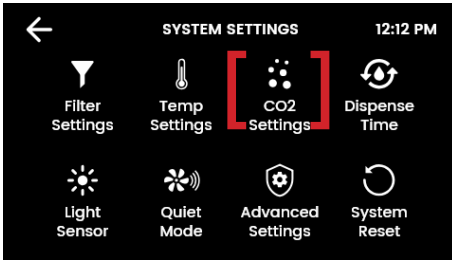
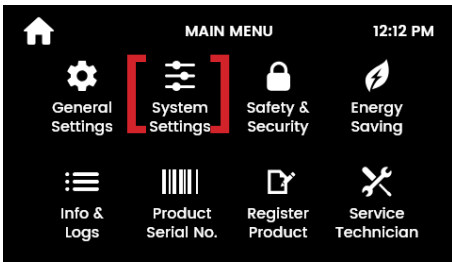

Purge CO₂

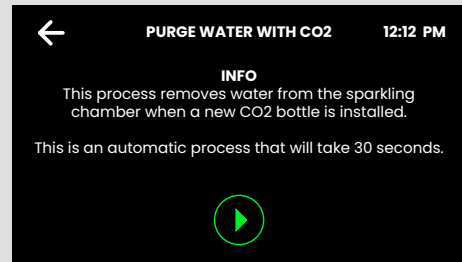

- Purge the gas lines when fitting a new CO₂ gas cylinder.
- Press the green start icon.
- The purge runs for 30 seconds.
- Water may be dispensed before CO₂ gas escapes from the tap.
- Water dispenses, then the CO₂ gas escapes through the tap.
- The purge process stops automatically.

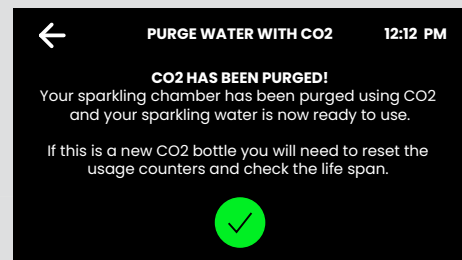
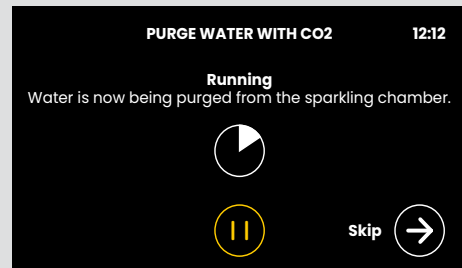

CO₂ reset

- After fitting a new CO₂ cylinder , reset the CO₂ counter.

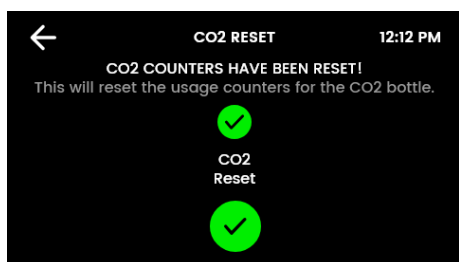

CO₂ life

- CO₂ life may be adjusted by months or litres.
- The Home screen displays a warning when the CO₂ level reaches 20% (see page 93).
- CO₂ life defaults to grams absorbed.
- Months of use may also be selected to trigger a reminder to prepare a replacement CO₂ cylinder.
- Usage is dependent on CO₂ absorption, settings on the HydroTap, and leak-free installation.
- CO₂ cylinders are available in two sizes:
 - 1.2kg (approx. 180-200L) for residential or commercial (UK).
 - 2.64kg (approx. 400-460L) for commercial (not available in UK).

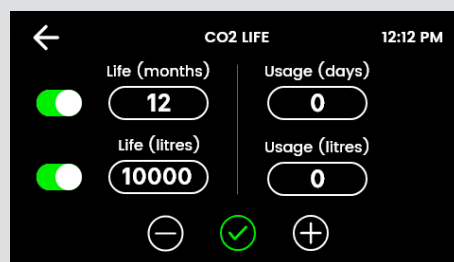

3.7.3 CO₂ settings continued

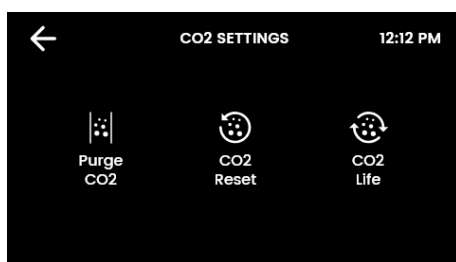
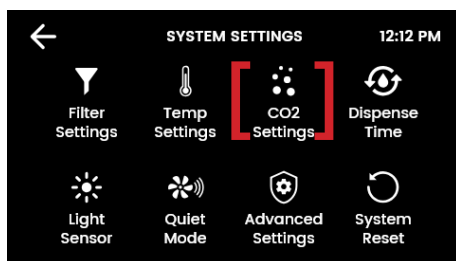
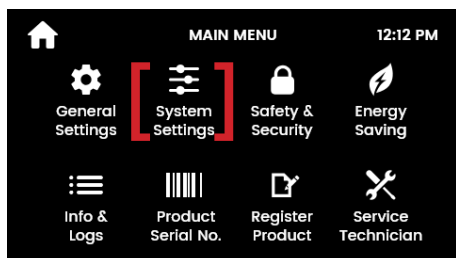

3.7.4 Dispense times

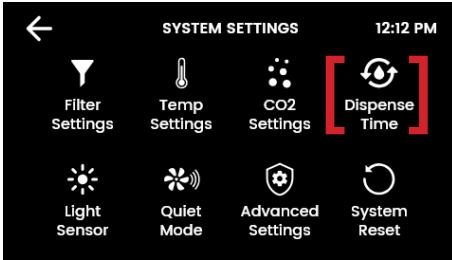
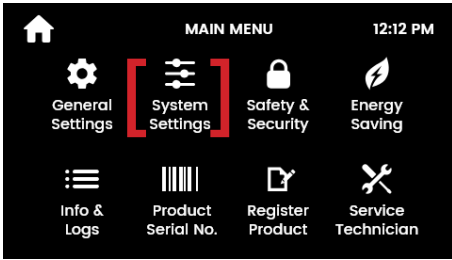

Dispense times

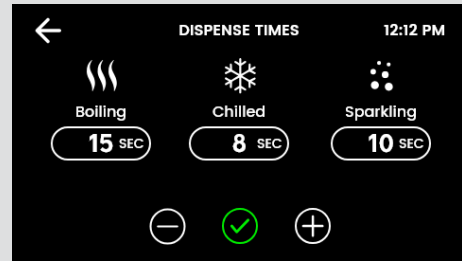

- Set the “bottle-fill” dispense time for each water type.
- Minimum dispense time: 5 seconds.
- Maximum dispense time: 15 seconds (default).

3.7.5 Light sensor

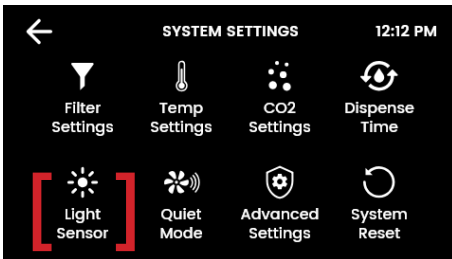
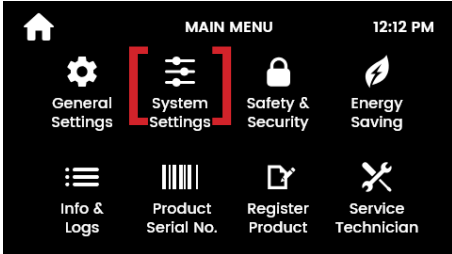

Light sensor

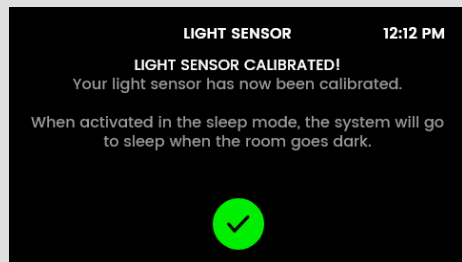
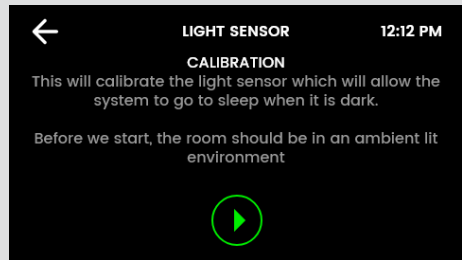

- Follow the screen instructions to calibrate the light sensor.
- Ensure the ambient light in the room is typical for operating conditions.
- The lights on the tap will flash to confirm calibration.
- When the room is darkened below the calibrated light level, the tap lights will turn OFF after 30 seconds.

3.7.6 Quiet mode

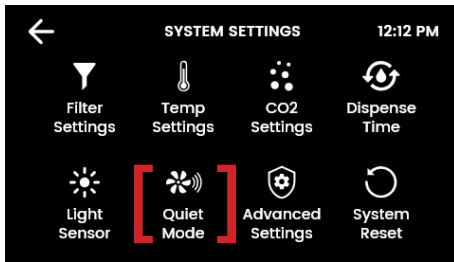
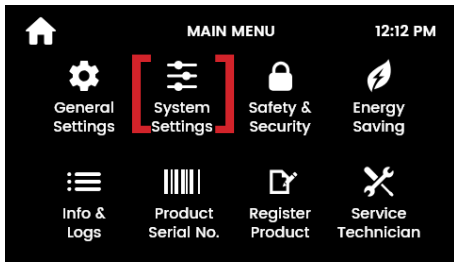

- Lowering the fan speed can reduce noise. Increasing it may improve chilling performance.
- Residential models: 75% / 100% / Auto (default).
- Commercial models: 100% (default) / Auto.

Quiet mode

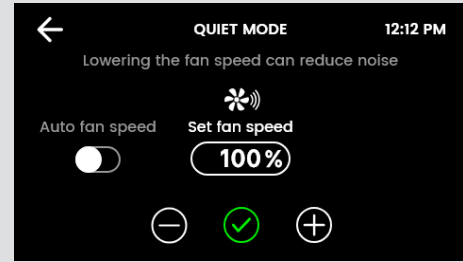
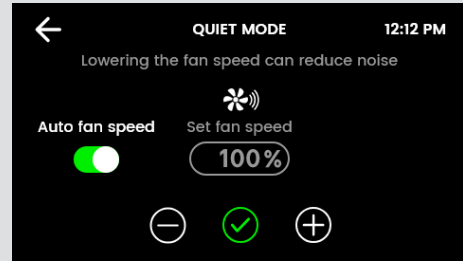

3.7.7 Advanced settings

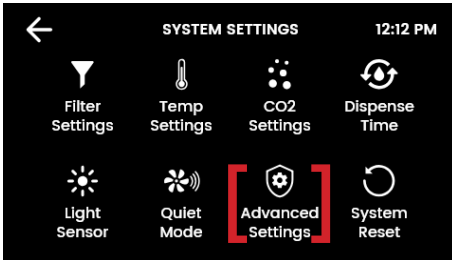
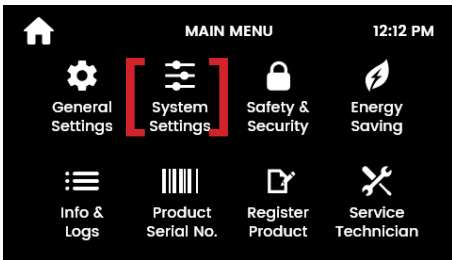

Advanced settings 1

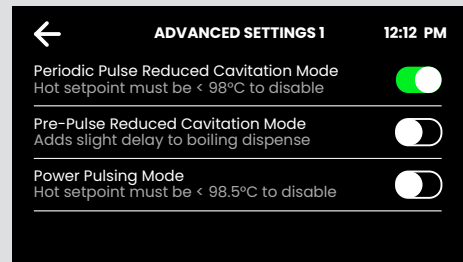

Advanced settings 1

Periodic pulse reduced cavitation mode

- Sends 2 electric pulses every 5 minutes to the pump.
- This prevents the build up of air bubbles inside the pump to ensure an even flow of hot water at the tap.

Pre- pulse reduced cavitation mode

- Pulses immediately before boiling dispense to prevents the build up of air bubbles inside the pump to ensure an even flow of hot water at the tap.
- There will be a 150 millisecond delay before water is dispensed.

Power pulsing mode

- Applies a closer tolerance to the set temperature, to ensure hot water is maintained as closely as possible to the set point.
- In rare occurrences, enabling this feature may cause the tap lights to flicker during the boiling water recovery period.

3.7.7 Advanced settings continued

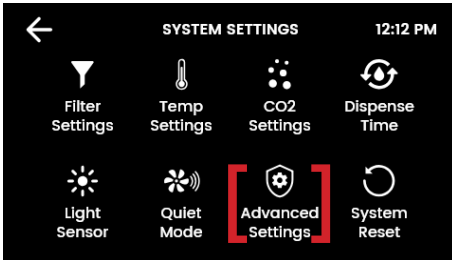
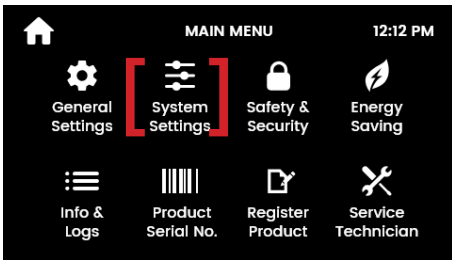

Advanced settings 2 (Wave Tap only)

Wave Tap Sensor Demister Mode

- Enabled (default): activates the Wave Tap internal heater to prevent its sensors from being affected by condensation from steam.
- Disabled: choose this option to conserve a small amount of power.

Wave Tap Lock Mode

- Disabled (default): Chilled or sparkling water can be dispensed by activating the corresponding sensor.
- Enabled: in addition to the chilled or sparkling sensor, the rear sensor must also be activated in order to dispense chilled or sparkling water. This is useful to prevent false activation if a highly reflective surface is present (such as high-visibility reflective tape).
- **Note** Bottle fill is disabled.

Advanced settings 2 (Wave Tap only)

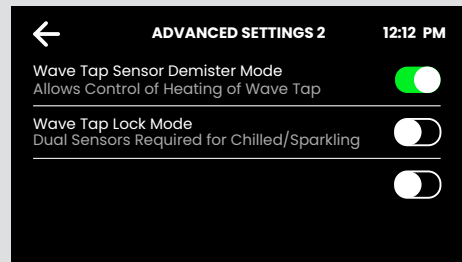

3.7.8 System restart

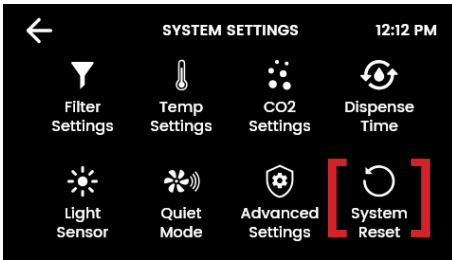
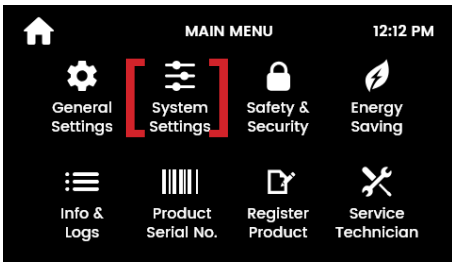

- Touch the top circle, then the bottom circle to power down and restart the system.
- Use this function to remove the settings access password.

3.8 Safety and security

Boiling safety

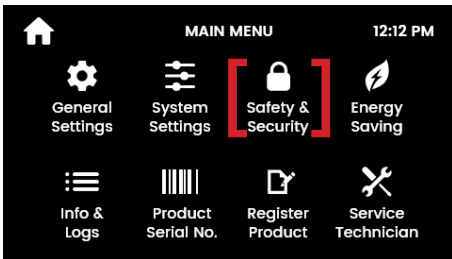

Boiling safety lock

- Enabled (default): safety button must be touched/tapped in order to dispense boiling water.
- Disabled: boiling water can be dispensed without the need to touch/tap the safety button.

Hot isolation

- 3 slow safety button presses are required prior to dispensing.

System restart

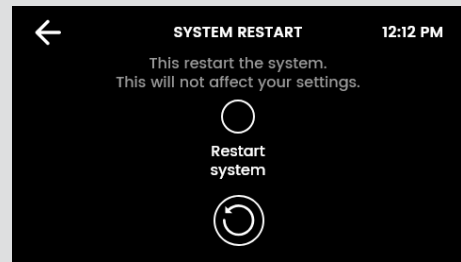

Boiling safety

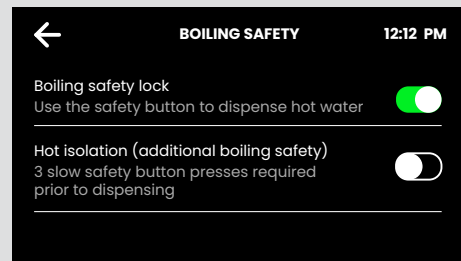

Passcode protect

- Navigate the icons, buttons and fields to create and set a password for GUI adjustment.

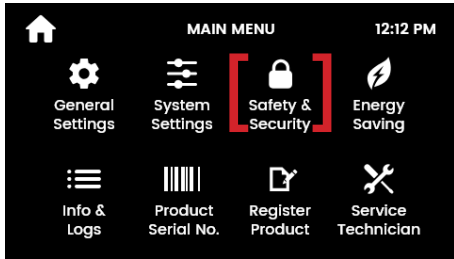

- Activate passcode protection to limit access to certain settings. Users will be prompted for this passcode when attempting to access settings.
- Create a 4-digit passcode and re-enter, as prompted.
- The passcode will be deactivated if the HydroTap is reset (powered off and on again).

Passcode protect

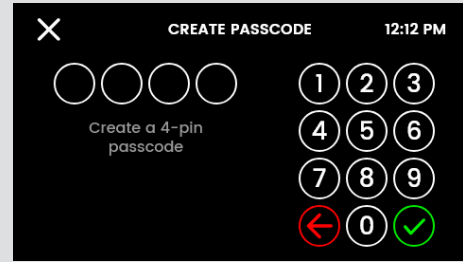

3.9 Energy saving

Sleep mode

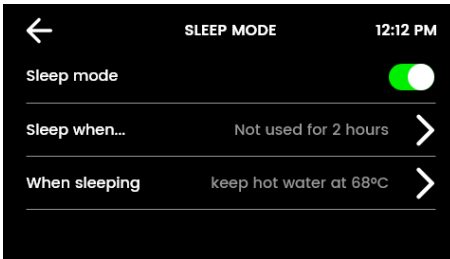
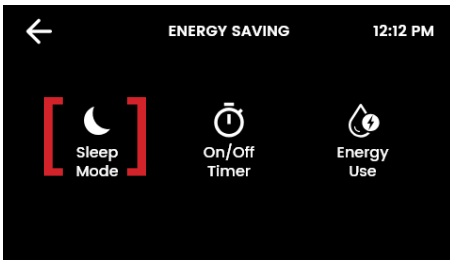
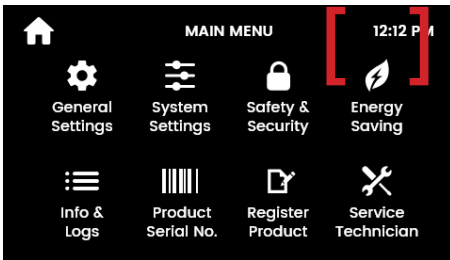

Sleep mode

- Disabled (default).
- Enabled: Any attempt to dispense water will bring the HydroTap out of sleep mode. Allow sufficient time for the water to reach the set temperature.

Sleep when

- It is recommended to recalibrate the light sensor after selecting “sleep when it gets dark”.
- Ensure the ambient light is typical for operating conditions. Refer to page [79](#).

When sleeping

- Choose between the following modes:
- Keep hot water at 68°C, (chilled water kept at setpoint for chilled models) (default mode).
- Turn system OFF, boiling and chilled water will be OFF.

Sleep mode

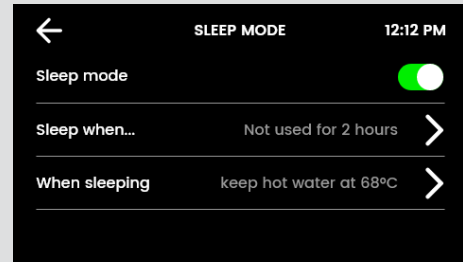

Sleep when

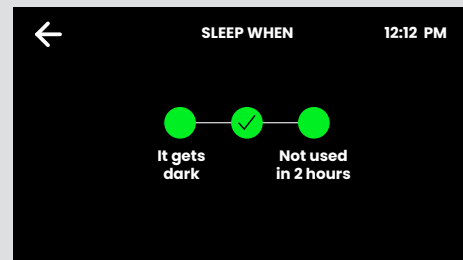

When sleeping

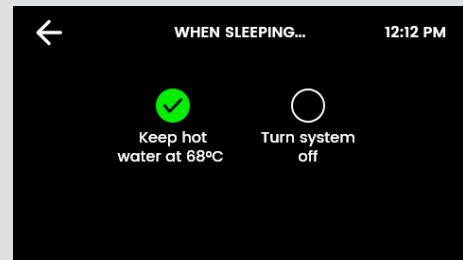

3.9 Energy saving continued

On / Off Timer

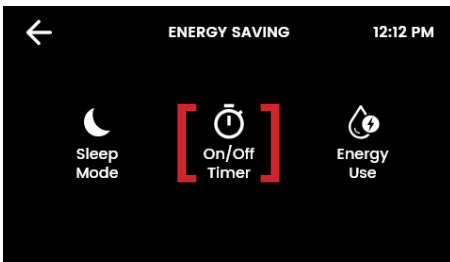
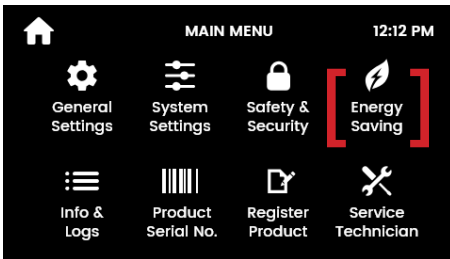

- The option that is in effect is highlighted.
- When OFF, the HydroTap will stop chilling and heating the drinking water.
- During OFF mode, any attempt to dispense water will bring the HydroTap back ON. Allow sufficient time for the water to reach the set temperature.
- After 30 minutes of non-use, the system will revert to the On / Off setting.

On / Off Timer

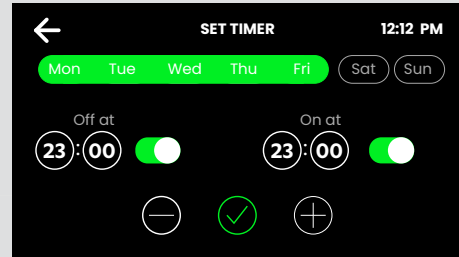
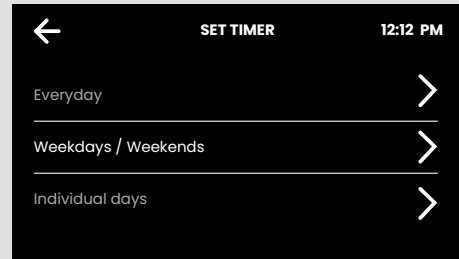

3.9 Energy saving continued

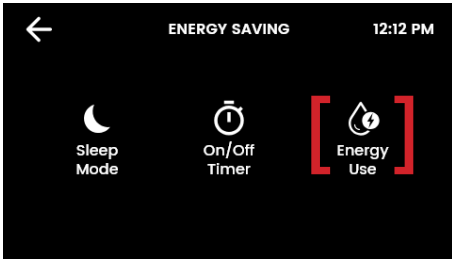
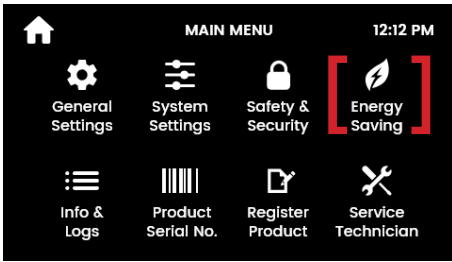

Energy use

- Track energy usage of your HydroTap by viewing the total energy consumed and the energy consumed since the last energy use reset.

Energy use

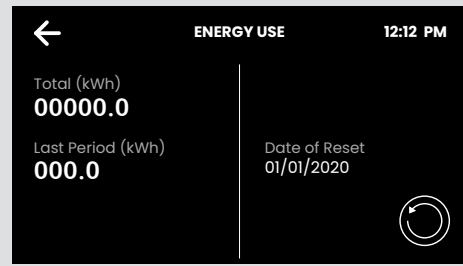

- Press icon to reset energy usage recording.

3.10 Info & logs

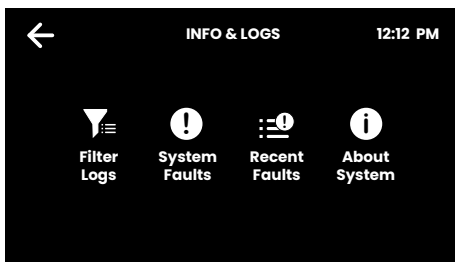
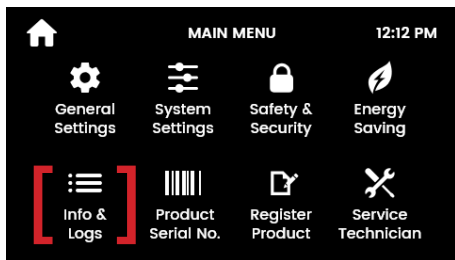

Filter Logs

- View the filter reset history (date and litres).

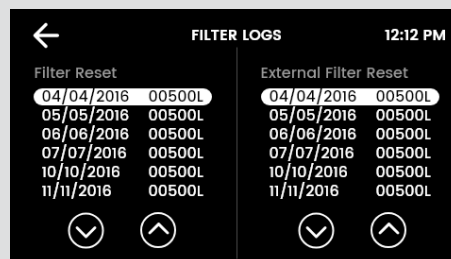

System Faults

- View the system fault history (code, description, date, time).

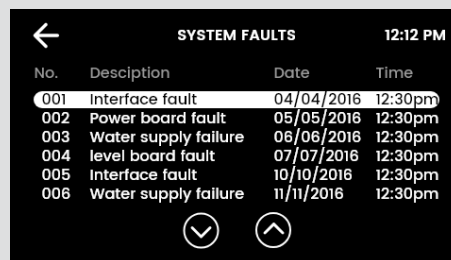

About System

- View the system credentials

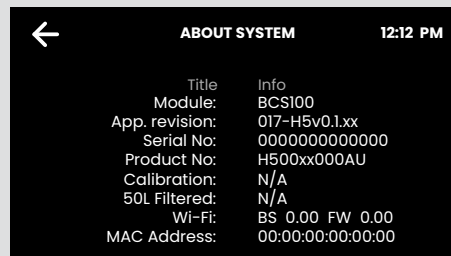

3.11 Product serial no.



Product serial no.

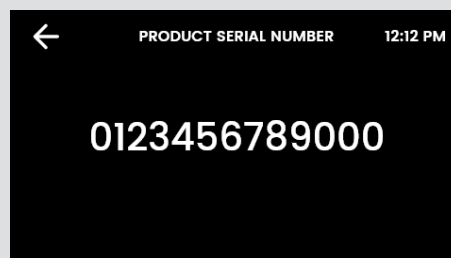

- View the product serial number, example shown above.

3.12 Register product

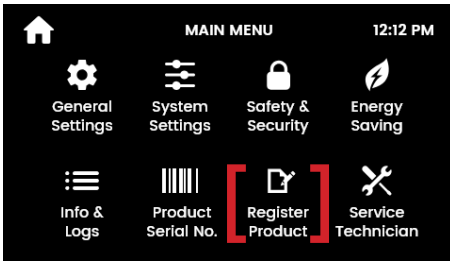

3.13 Service Technician



- Access to functional and diagnostic aspects of the HydroTap system are limited to qualified Service Technicians only. Contact Zenith if you need a Service Technician.

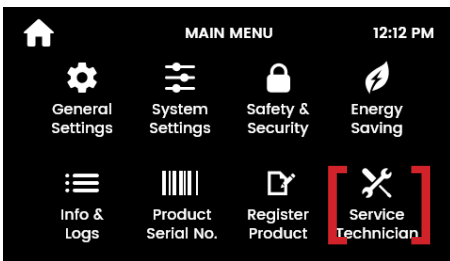

Register product



Service Technician access

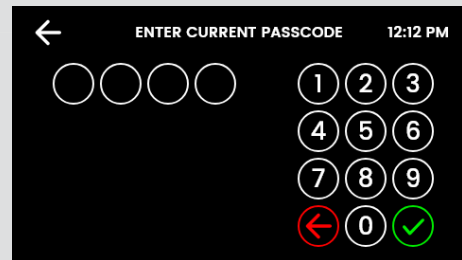
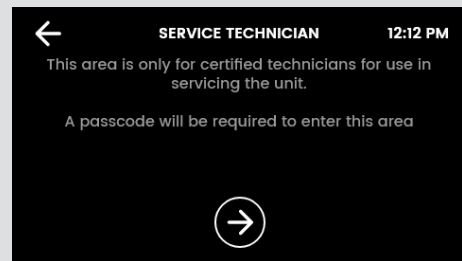

4.1 Filter maintenance

- The HydroTap notifies when filter replacement is due. If you notice one of the following, you will need to change the filter.
- The tap and screen will indicate that a filter needs to be changed.
- Depending on local water quality conditions and usage, the filter may require changing before the filter change indication is shown. You may also need to replace the filter if you notice an increase in chlorine, taste or odour.

4.1.1 Internal filter change

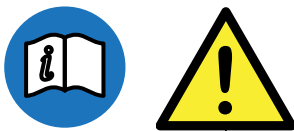

- Remove old filter.
- Open the filter door.
- Place a cloth or towel under the filter cartridge before removing.
- Grip the cartridge, turn it clockwise, then pull down.
- Water will drip as the cartridge is removed.
- Do not tilt the cartridge as water may spill from it if tilted.

Internal filter change

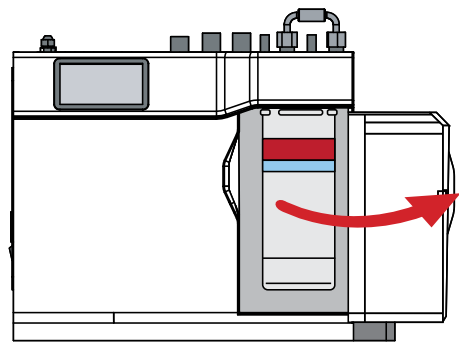
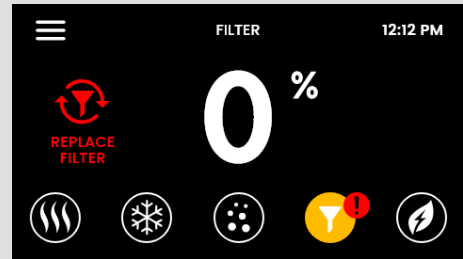

Open filter door.

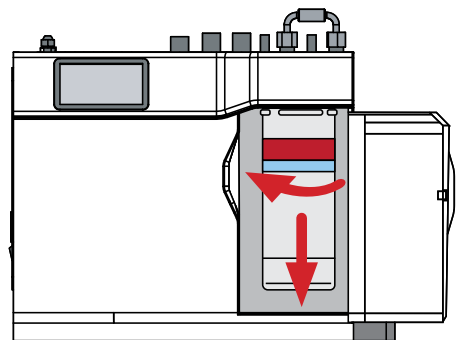

Remove old filter.

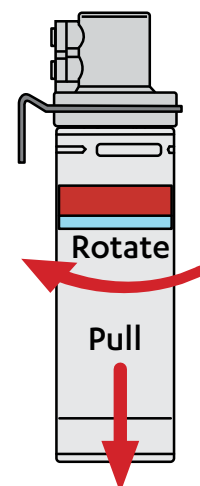

4.1 Filter maintenance continued

4.1.1 Internal filter change continued

- Unpack replacement filter cartridge and remove sanitary cap,
- Write today's date where shown on the label.
- Avoid touching the filter o-rings and filter opening as this may cause bacterial contamination of the cartridge.
- Moisten the o-rings with water.
- Align the front cartridge label to the left, and push the new cartridge up into the filter head.
- Turn the cartridge a quarter turn anticlockwise until it comes to a complete stop and locks, with the front label facing forward.
- Initiate the filter flush programme by scrolling through the menu screen (see page 98).
- When completed, clean up and dispose of old cartridge and packaging.
- Close the door to secure the appliance.
- Adjust the filter settings (see page 100) litres and days.
- If the HydroTap G5 is switched off for a long period of time (e.g. more than a weekend), run water through the chilled water outlet for at least 60 seconds before consumption.

Internal filter change continued

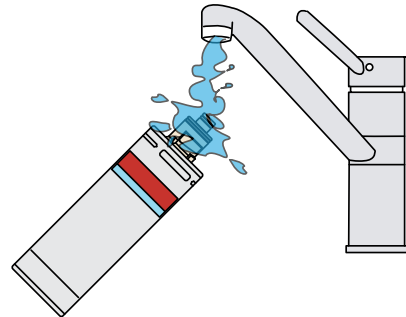

Moisten connector o-rings.

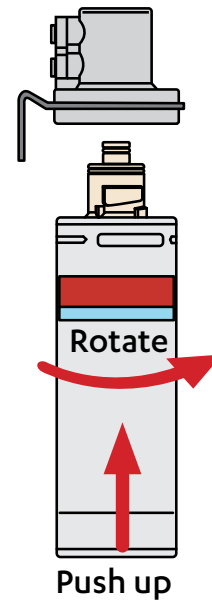

Fit new filter.

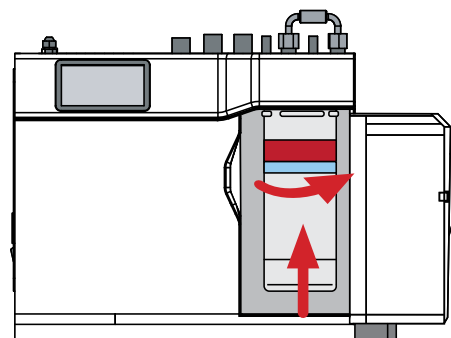

4.1 Filter maintenance continued

4.1.2 Air inlet filter maintenance

- The HydroTapG4 air filter is conveniently located on the outside of the condenser.
- The filter screen is a sliding fit in the plastic housing on the left hands side of the Command Centre.
- The screen may be removed for cleaning by sliding it forward.
- This needs to be inspected at least quarterly, cleaned and replaced if damaged.
- Rinse off with tap water.
- Gently dry with a cloth or towel.
- **Note** For best performance the unit should only be operated with a clean air filter screen, correctly fitted in place.
- Maintain at least a 50mm air gap in front of the screen at all times.
- Take care not to allow cloths or other soft materials to accidentally block the air inlet.

4.2 Cleaning

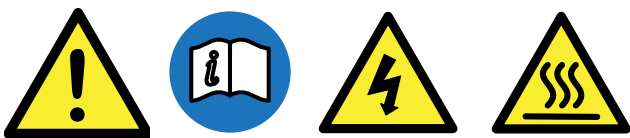

- Wipe surfaces with a damp cloth or antibacterial alcohol wipes, then wipe dry with a clean, dry microfibre cloth or paper towel.
- Food-grade disinfection wipes may be used to clean around and within the tap spout.



IMPORTANT

- Do not use strong, corrosive, or abrasive cleaning materials.
- Do not use air-drying disinfectant sprays.
- Failure to remove the cleaning liquid may damage the finish of the tap.

Touch-Free Wave Tap

- Do not use abrasives to clean the sensor lenses at the sides, top and rear of the tap.
- This could cause permanent malfunction and void warranty.

Air inlet filter maintenance

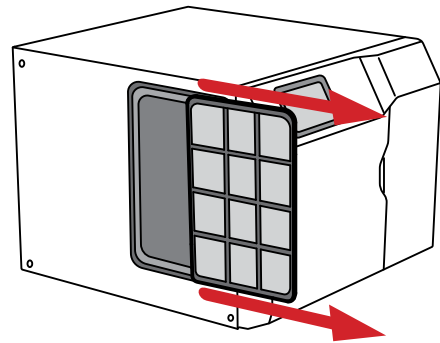

Slide forward to remove.



Rinse off with tap water.

4.3 The CO₂ cylinder and regulator



Significant concentrations of CO₂ gas can cause harm.



To prevent leaks, read and use the instructions and safety documents provided with the replacement cylinder, together with these instructions.



If removing hose, take care not to lose plastic olive from the fitting.

Universal G5 CO₂ regulator

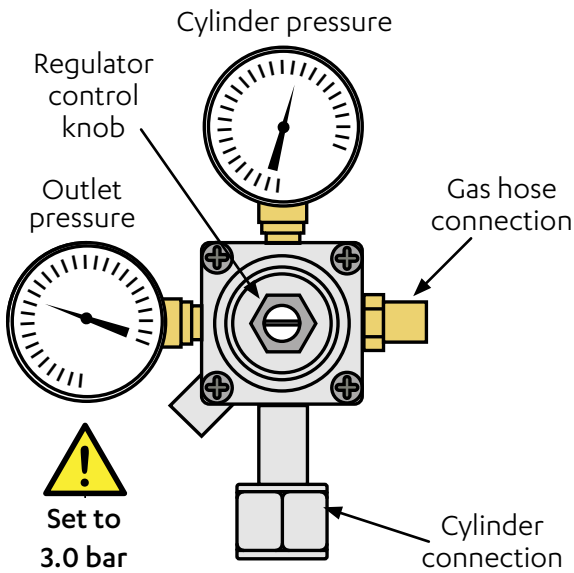

1.2kg cylinder Non-adjustable regulator

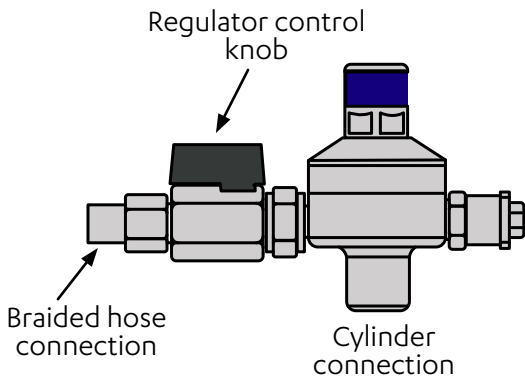

The CO₂ cylinder and regulator
Identifying the components

2.64kg cylinder

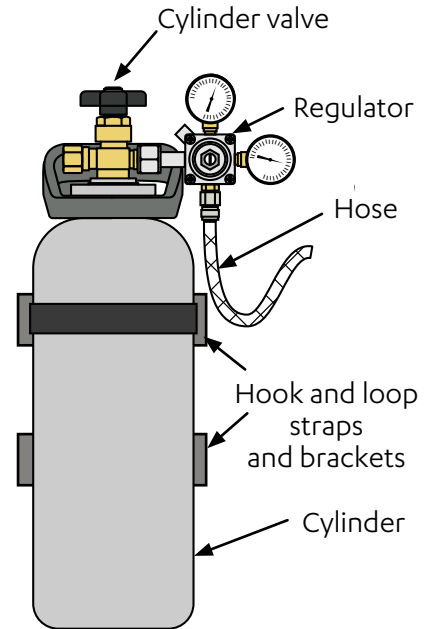

1.2kg cylinder

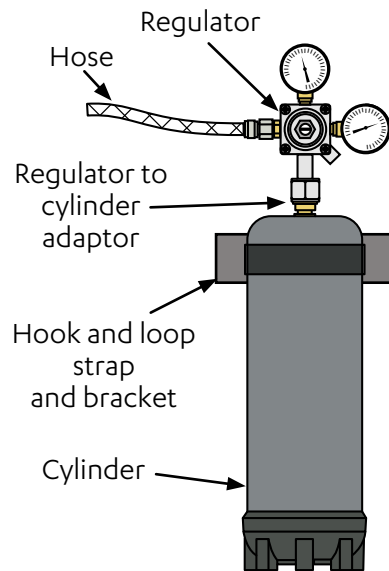

Non-adjustable 1.2kg cylinder regulator

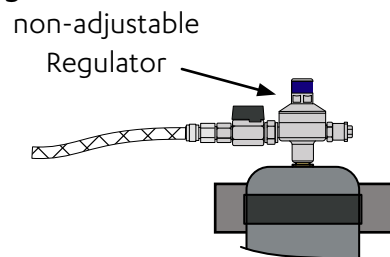

Changing the 2.64kg CO₂ cylinder

1

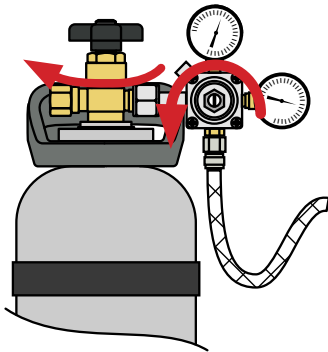

- Turn off cylinder valve & regulator.

2

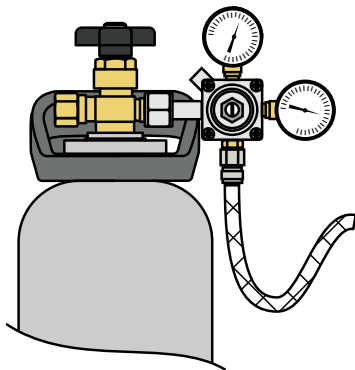

- Unstrap.

3

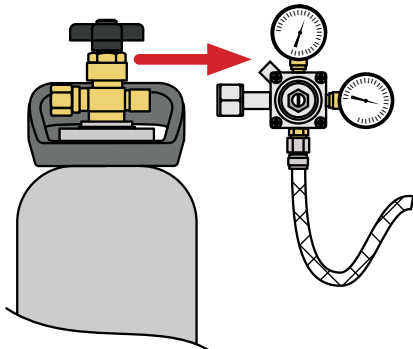

- Unscrew regulator connection.

4

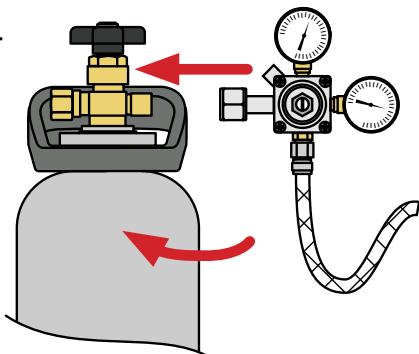

- Replace cylinder and refit regulator.

5

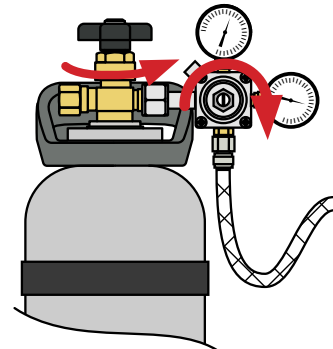

- Turn on the cylinder valve.
- Adjust outlet pressure 3.0 bar.

6

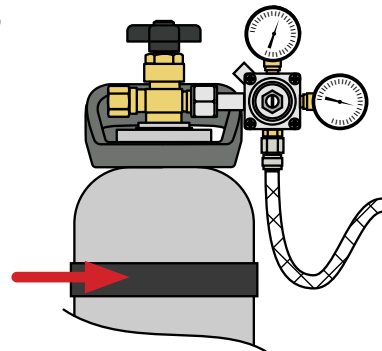

- Strap in place.

7

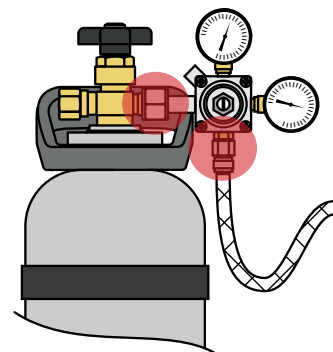

- Test for leaks in these areas
 - Test for leaks by brushing with soapy water and looking for bubbles.
 - Reseal if leaking, or call Zenith for advice and assistance.

8

- Purge, reset and set the CO₂ life, (see page [104](#)).

Changing the 1.2kg CO₂ cylinder Adjustable regulator

1

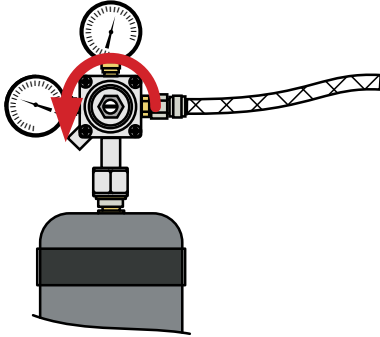

- Turn off regulator.

2

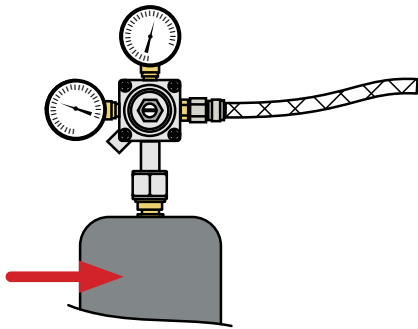

- Unstrap.

3

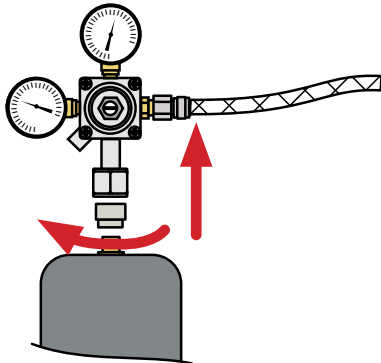

- Unscrew regulator connection.

4

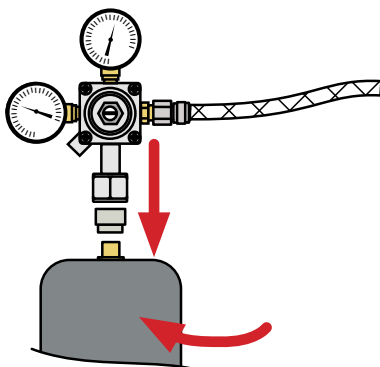

- Replace cylinder and refit regulator inc. adaptor.

5

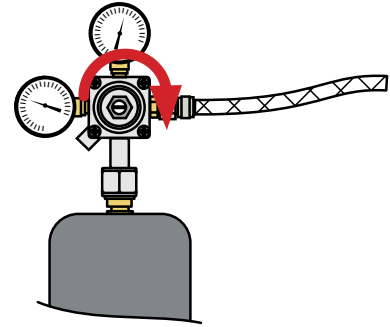

- Adjust outlet pressure 3.0 bar.

6

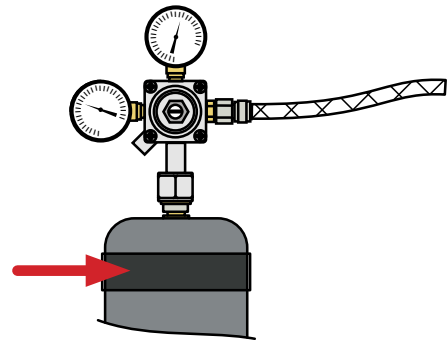

- Strap in place.

7

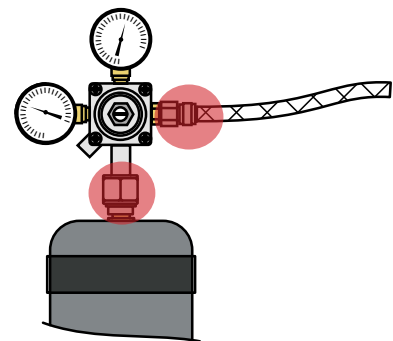

- Test for leaks in these areas

- Test for leaks by brushing with soapy water and looking for bubbles.
- Reseal if leaking, or call Zenith for advice and assistance.

8

- Purge, reset and set the CO₂ life, (see page [104](#)).

Changing the 1.2kg CO₂ cylinder
Non-adjustable regulator

1

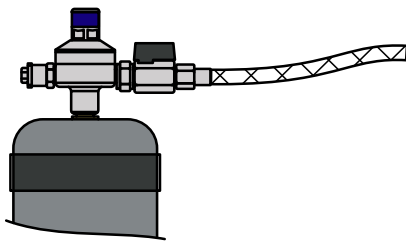
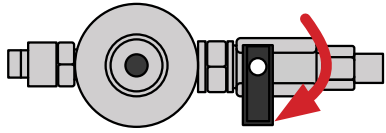

Turn off regulator.

2

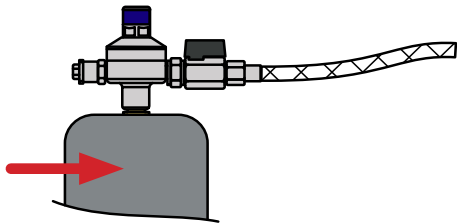

Unstrap.

3

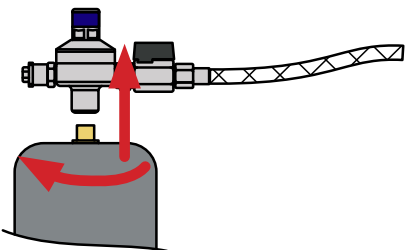

Unscrew regulator connection.

4

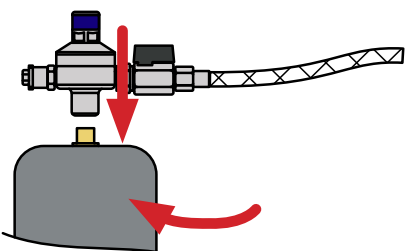

Replace cylinder and refit regulator.

5

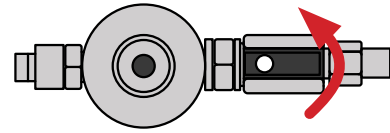

Turn ON regulator valve.

6

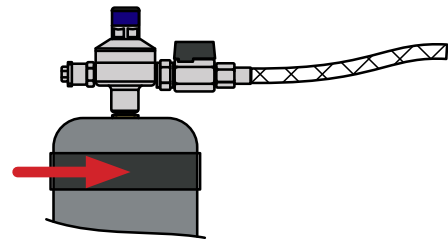

Strap in place.

7

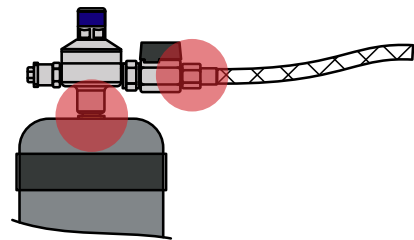

● Test for leaks in these areas

- Test for leaks by brushing with soapy water and looking for bubbles.
- Reseal if leaking, or call Zenith for advice and assistance.

8

Purge, reset and set the CO₂ life, (see page [104](#)).



Zenith Heaters Limited
IRD/GST No. 95 640 729
18 Kawakawa Place,
Westgate,
Auckland 0814,
New Zealand
Ph +(64 9) 838 8612
Free Call 0800 558 055

www.zenithwater.co.nz